

The right choice for the ultimate yield!

LS ELECTRIC strives to maximize your profits in gratitude for choosing us as your partner.

## Programmable Logic Control

# XGB Main unit(XBM-H Type)

XGT Series

User Manual

XBM-DN32H



### Safety Instructions

- Read this manual carefully before installing, wiring, operating, servicing or inspecting this equipment.
- Keep this manual within easy reach for quick reference.

**LS**ELECTRIC

### Before using the product ...

For your safety and effective operation, please read the safety instructions thoroughly before using the product.



- ▶ Safety Instructions should always be observed in order to prevent accident or risk with the safe and proper use the product.
- ▶ Instructions are separated into “Warning” and “Caution”, and the meaning of the terms is as follows;



Indicates a potentially hazardous situation which, if not avoided, could result in death or serious injury



Indicates a potentially hazardous situation which, if not avoided, may result in minor or moderate injury. It may also be used to alert against unsafe practices

- ▶ The marks displayed on the product and in the user's manual have the following meanings.
  -  Be careful! Danger may be expected.
  -  Be careful! Electric shock may occur.
- ▶ The user's manual even after read shall be kept available and accessible to any user of the product.

## Safety Instructions when designing

### Warning

- ▶ **Please, install protection circuit on the exterior of PLC to protect the whole control system from any error in external power or PLC module.** Any abnormal output or operation may cause serious problem in safety of the whole system.
  - Install applicable protection unit on the exterior of PLC to protect the system from physical damage such as emergent stop switch, protection circuit, the upper/lowest limit switch, forward/reverse operation interlock circuit, etc.
  - If any system error (watch-dog timer error, module installation error, etc.) is detected during CPU operation in PLC, the whole output is designed to be turned off and stopped for system safety. However, in case CPU error if caused on output device itself such as relay or TR can not be detected, the output may be kept on, which may cause serious problems. Thus, you are recommended to install an addition circuit to monitor the output status.
  
- ▶ **Never connect the overload than rated to the output module nor allow the output circuit to have a short circuit,** which may cause a fire.
  
- ▶ **Never let the external power of the output circuit be designed to be On earlier than PLC power,** which may cause abnormal output or operation.
  
- ▶ **In case of data exchange between computer or other external equipment and PLC through communication or any operation of PLC (e.g. operation mode change), please install interlock in the sequence program to protect the system from any error.** If not, it may cause abnormal output or operation.

## Safety Instructions when designing

### **Caution**

- ▶ **I/O signal or communication line shall be wired at least 100mm away from a high-voltage cable or power line.** If not, it may cause abnormal output or operation.

## Safety Instructions when designing

### **Caution**

- ▶ **Use PLC only in the environment specified in PLC manual or general standard of data sheet.** If not, electric shock, fire, abnormal operation of the product or flames may be caused.
- ▶ **Before installing the module, be sure PLC power is off.** If not, electric shock or damage on the product may be caused.
- ▶ **Be sure that each module of PLC is correctly secured.** If the product is installed loosely or incorrectly, abnormal operation, error or dropping may be caused.
- ▶ **Be sure that I/O or extension connector is correctly secured.** If not, electric shock, fire or abnormal operation may be caused.
- ▶ **If lots of vibration is expected in the installation environment, don't let PLC directly vibrated.** Electric shock, fire or abnormal operation may be caused.
- ▶ **Don't let any metallic foreign materials inside the product,** which may cause electric shock, fire or abnormal operation..

## Safety Instructions when wiring

### Warning

- ▶ **Prior to wiring, be sure that power of PLC and external power is turned off.** If not, electric shock or damage on the product may be caused.
- ▶ **Before PLC system is powered on, be sure that all the covers of the terminal are securely closed.** If not, electric shock may be caused

### Caution

- ▶ **Let the wiring installed correctly after checking the voltage rated of each product and the arrangement of terminals.** If not, fire, electric shock or abnormal operation may be caused.
- ▶ **Secure the screws of terminals tightly with specified torque when wiring.** If the screws of terminals get loose, short circuit, fire or abnormal operation may be caused.
- \*
  - ▶ **Surely use the ground wire of Class 3 for FG terminals, which is exclusively used for PLC.** If the terminals not grounded correctly, abnormal operation may be caused.
  - ▶ **Don't let any foreign materials such as wiring waste inside the module while wiring,** which may cause fire, damage on the product or abnormal operation.

## Safety Instructions for test-operation or repair

### **Warning**

- ▶ **Don't touch the terminal when powered.** Electric shock or abnormal operation may occur.
- ▶ **Prior to cleaning or tightening the terminal screws, let all the external power off including PLC power.** If not, electric shock or abnormal operation may occur.
- ▶ **Don't let the battery recharged, disassembled, heated, short or soldered.** Heat, explosion or ignition may cause injuries or fire.

### **Caution**

- ▶ **Don't remove PCB from the module case nor remodel the module.** Fire, electric shock or abnormal operation may occur.
- ▶ **Prior to installing or disassembling the module, let all the external power off including PLC power.** If not, electric shock or abnormal operation may occur.
- ▶ **Keep any wireless installations or cell phone at least 30cm away from PLC.** If not, abnormal operation may be caused.

## Safety Instructions for waste disposal

### **Caution**

- ▶ **Product or battery waste shall be processed as industrial waste.** The waste may discharge toxic materials or explode itself.



# Revision History

Version	Date	Remark	Part	Page
V 1.0	2016.12	1. First Edition	-	-
V 1.1	2020.06	LSIS to change its corporate name to LS ELECTRIC		Entire
V1.2	2021.09	1. Modify partner port range	4	4-Ch1
V1.3	2022.06	1. Instructions for System Configuration changed	1	2-9
V1.4	2022.09	Change domain (lselectric.co.kr -> ls-electric.com)		Entire





## About User's Manual

Congratulations on purchasing PLC of LS ELECTRIC Co.,Ltd.

Before use, make sure to carefully read and understand the User's Manual about the functions, performances, installation and programming of the product you purchased in order for correct use and importantly, let the end user and maintenance administrator to be provided with the User's Manual.

The Use's Manual describes the product. If necessary, you may refer to the following description and order accordingly. In addition, you may connect our website(<http://www.ls-electric.com/>) and download the information as a PDF file.

### Relevant User's Manual

Title	Description	No. of User Manual
XG5000 User's Manual	It describes how to use XG5000 software especially about online functions such as programming, printing, monitoring and debugging by using XGT series products.	10310000512
XGK/XGB Series Instruction & Programming	It describes how to use the instructions for programming using XGK/XGB series.	10310000510
XBC Ultimate Performance XGB Unit	It describes how to use XGB main unit, system configuration, mechanism ,program function ,input/output function, Built-in High-speed Counter, Datalog, PID Control, Built-in Communication function, Built-in Position, Built-in Analog input/output..	10310001374
XGB Analog User's Manual	It describes how to use the specification of analog input/analog output/temperature input module, system configuration and built-in PID control for XGB main unit.	10310000920
XGB Position User's Manual	It describes how to use built-in Position function for XGB main unit.	10310000927
XGB Cnet I/F User's Manual	It describes how to use built-in communication function for XGB main unit and external Cnet I/F module.	10310000816
XGB Fast Ethernet I/F User's Manual	It describes how to use XGB FEnet I/F module.	10310000873
CANopen Communication Module	It describes how to use XGB CANopen Communication Module	0310001245
EtherNet/IP Communication Module	It describes how to use XGB EtherNet/IP Communication module	10310001159
XGB Profibus-DP I/F (Master) User's Manual	It describes how to use XGB Profibus-DP I/F (Master) Communication Module	10310001310
XGB Profibus-DP I/F (Slave) User's Manual	It describes how to use XGB Profibus-DP I/F (Slave) Communication Module	10310001410
XGB DeviceNet I/F (Slave) User's Manual	It describes how to use XGB DeviceNet I/F (Slave) Communication Module	10310001414
XGB High speed counter module User's Manual	It describes how to use High speed counter(XBF-HO02A, XBF-HD02A)	10310001240



© **Contents** ©

**1: System**

<b>Chapter 1 Introduction</b> .....	<b>1-1~1-17</b>
1.1 Guide to Use This Manual.....	1-1
1.2 Features .....	1-2
1.3 Terminology .....	1-5
<b>Chapter 2 System Configuration</b> .....	<b>2-1~2-13</b>
2.1 Table of Products Configuration .....	2-1
2.2 Classification and Type of Product Name .....	2-3
2.3 XBM 'H' Type's System Configuration .....	2-8
<b>Chapter 3 Specifications</b> .....	<b>3-1~3-10</b>
3.1 Names and Functions of Each Part.....	3-1
3.2 General specifications .....	3-2
3.3 Power specifications .....	3-3
3.4 Battery .....	3-6
3.5 Performance specifications .....	3-7
<b>Chapter 4 Installation and wiring</b> .....	<b>4-1~4-16</b>
4.1 Parameter & Operation data.....	4-1
4.2 Attachment/Detachment of Modules.....	4-7
4.3 Wire.....	4-12

**Chapter 5 Maintenance ..... 5-1~5-36**

5.1 Maintenance and Inspection ..... 5-1  
 5.2 Daily Inspection ..... 5-1  
 5.3 Periodic Inspection ..... 5-2

**Chapter 6 Troubleshooting..... 6-1~6-13**

6.1 Basic Procedure of Troubleshooting ..... 6-1  
 6.2 Troubleshooting ..... 6-1  
 6.3 Troubleshooting Questionnaire ..... 6-7  
 6.4 Troubleshooting Examples ..... 6-8  
 6.5 Error Code List ..... 6-12

**Chapter 7 EMC Standard ..... 7-1~7-4**

7.1 Requirements for Conformance to EMC Directive ..... 7-1  
 7.2 Requirement to Conform to the Low-voltage Directive..... 7-4

## 2: Basic Functions

<b>Chapter 1 Program Configuration and Operation Method ..... 1-1~1-26</b>
--

1.1 Programming Basics.....	1-1
1.2 Operation Mode .....	1-23
1.3 Memory.....	1-26

<b>Chapter 2 CPU Function ..... 2-1~2-36</b>
--

2.1 Type Setting.....	2-1
2.2 Parameter Settin.....	2-2
2.3 RTC Function .....	2-13
2.4 Time Counter Function .....	2-15
2.5 Remote Function .....	2-21
2.7 I/O forced On/Off Function .....	2-22
2.8 Direct I/O Function .....	2-23
2.9 Function saving the operation history.....	2-24
2.10 How to allocate I/O No.....	2-25
2.11 Read I/O information.....	2-29
2.12 Monitoring Functions .....	2-30
2.13 PLC's Read-Protect Function .....	2-35
2.14 Function to delete all of the PLC.....	2-36

<b>Chapter 3 Input/Output Specifications..... 3-1~3-24</b>
--

3.1 Introduction .....	3-1
3.2 Main Unit Digital Input Specifications.....	3-4
3.3 Main Unit Digital Output Specifications.....	3-5
3.4 Digital Input Specifications .....	3-6
3.5 Digital Output Specifications .....	3-9
3.6 Combined Digital I/O module Input Specification.....	3-18
3.7 Combined Digital I/O module Output Specification .....	3-19
3.8 I/O modules' Functions .....	3-21

**Chapter 4 Built-in High-speed Counter Function..... 4-1~4-33**

<b>4.1 High-speed Counter Specifications .....</b>	<b>4-1</b>
<b>4.2 Installation and Wiring .....</b>	<b>4-23</b>
<b>4.3 Internal Memory.....</b>	<b>4-24</b>
<b>4.4 Examples: Using High-speed Counter .....</b>	<b>4-29</b>
<b>3.5 Digital Output Specifications.....</b>	<b>3-9</b>
<b>3.6 Combined Digital I/O module Input Specification.....</b>	<b>3-18</b>
<b>3.7 Combined Digital I/O module Output Specification.....</b>	<b>3-19</b>
<b>3.8 I/O modules' Functions .....</b>	<b>3-21</b>

**Chapter 5 Built-in PID Function ..... 5-1~5-50**

<b>5.1 Features of Built-in PID Function .....</b>	<b>5-1</b>
<b>5.2 Basic Theory of PID Control .....</b>	<b>5-2</b>
<b>5.3 Functional Specifications of PID Control.....</b>	<b>5-9</b>
<b>5.4 Usage of PID Control Functions .....</b>	<b>5-10</b>
<b>5.5 PID Instructions .....</b>	<b>5-26</b>
<b>5.6 PID Auto-tuning.....</b>	<b>5-28</b>
<b>5.7 Example Programs .....</b>	<b>5-37</b>
<b>5.8 Error / Warning Codes .....</b>	<b>5-49</b>

## 3: Positioning

**Chapter 1 Overview ..... 1-1~1-8**

- 1.1 General ..... 1-1
- 1.2 Performance specifications ..... 1-3
- 1.3 Operation Sequence of Positionin ..... 1-4
- 1.4 I/O Signal Allocation ..... 1-6

**Chapter 2 General Specifications ..... 2-1~2-3**

- 2.1 Input Specifications ..... 2-1
- 2.2 Output Specifications ..... 2-2

**Chapter 3 Before Positioning ..... 3-1~3-53**

- 3.1 Positioning Function ..... 3-1
- 3.2 Positioning Parameter ..... 3-26
- 3.3 Positioning Operation Data ..... 3-40
- 3.4 Positioning Status Monitoring and Area K for Input and Output ..... 3-48

**Chapter 4 Positioning Check ..... 4-1~4-33**

- 4.1 The Sequence of Positioning Check ..... 4-1
- 4.2 Making of Operation Check Program ..... 4-2

**Chapter 5 Positioning Instructions ..... 5-1~5-46**

- 5.1 Positioning Instruction List ..... 5-1
- 5.2 Details of Positioning Instructions ..... 5-2



**Chapter 6 Positioning Monitoring Package ..... 6-1~6-8**

- 6.1 Introduction to Positioning Monitoring Package.....6-1
- 6.2 Menus and Functions of Positioning Monitoring .....6-3
- 6.3 Parameter/Operation Data Setting Using Monitoring Package .....6-7

**Chapter 7 Positioning Monitoring Package ..... 7-1~7-17**

- 7.1 System Composition and Setting of Input and Output.....7-1
- 7.2 Program Examples .....7-2

**Chapter 8 Troubleshooting Procedure ..... 8-1~8-12**

- 8.1 Basic Procedure of Troubleshooting..... 8-1
- 8.2 Check by Using the LED ..... 8-2
- 8.3 Check by Error Code..... 8-5
- 8.4 Check of Motor Failures..... 8-12

**Chapter 9 Positioning Instruction and K area List ..... 9-1~9-12**

- 9.1 Positioning Instruction ..... 9-1
- 9.2 Positioning Dedicated K area List ..... 9-12

**Chapter 10 Motor Wiring Example ..... 10-1~10-5**

- 10.1 Stepping Motor Wiring Example ..... 10-1
- 10.2 Servo Motor Wiring Example..... 10-2

## 4: Communication

**Chapter 1 Built-in FEnet Communication..... 1-1~1-99**

- 1.1 Outline ..... 1-1
- 1.2 Specifications ..... 1-2
- 1.3 Specifications of installation and a trial run ..... 1-8
- 1.4 Configuration of FEnet communication system ..... 1-12
- 1.5 Protocols for each service..... 1-14
- 1.6 Dedicated services ..... 1-29
- 1.7 P2P services ..... 1-35
- 1.8 High speed link..... 1-62
- 1.9 Remote communication..... 1-73
- 1.10 E-mail Transfer(SMTP) ..... 1-77
- 1.11 Time synchronization(SNTP)..... 1-92
- 1.12 Trouble Shooting ..... 1-98

**Chapter 2 Built-in Cnet Communication..... 2-1~2-122**

- 2.1 General ..... 2-1
- 2.2 Specification ..... 2-2
- 2.3 Cnet Communication System Configuration ..... 2-8
- 2.4 Basic Setting for Communication ..... 2-15
- 2.5 Server Function and P2P service ..... 2-22
- 2.6 XGT Dedicated Protocol ..... 2-46
- 2.7 LSBus Protocol ..... 2-66
- 2.8 MODBus Protocol..... 2-72
- 2.9 Diagnosis Function ..... 2-87
- 2.10 Example Program ..... 2-96
- 2.11 Error Code ..... 2-2

## Appendix

**Appendix 1 Flag List ..... App. 1-1~App.1-11**

**Appendix 1.1 Special Relay (F) List ..... App. 1-1**

**Appendix 1.2 Communication Relay (L) List..... App. 1-6**

**Appendix 1.3 Network Register (N) List ..... App. 1-10**

**Appendix 2 Dimension..... App.2-1~App.2-4**

**Appendix 3 Instruction List ..... App.3-1~App.3-41**

**Appendix 3.1 Classification of Instructions ..... App.4-1**

**Appendix 3.2 Basic Instructions ..... App.4-2**

**Appendix 3.3 Application Instruction ..... App.4-5**

**Appendix 3.4 Special/Communication Instruction ..... App.4-38**

## Part 1. System

### Chapter 1 Introduction

#### 1.1 Guide to this Manual

This manual includes specifications, functions and handling instructions for XGB series PLC. This manual is divided up into chapters as follows

	No.	Title	Contents
1.System	Chapter 1	Introduction	Describes configuration of this manual, unit's features and terminology.
	Chapter 2	System Configurations	Describes available units and system configuration in the XGB series.
	Chapter 3	Specifications	Describes general specifications of units used in the XGB series.
	Chapter 4	CPU Specifications	Describes performances, specifications and operations.
	Chapter 5	Maintenance	Describes the check items and method for long-term normal operation of the PLC system.
	Chapter 6	Troubleshooting	Describes various operation errors and corrective actions.
	Chapter 7	EMC Specifications	Describes system configuration following EMC specification.
2.Main	Chapter 1	Program Configuration and Operation Method	Describes performances, specifications and operations.
	Chapter 2	CPU Specifications	
	Chapter 3	Input/Output Specifications	Describes operation of basic and input/output.
	Chapter 4	Built-in High-speed Counter Function	Describes built-in high-speed counter functions.
	Chapter 5	Built-in PID Function	Describes Built-in PID Function
3.Positioning	Chapter 1	Overview	Describes the specification, method to use each positioning function, programming and the wiring with external equipment of embedded positioning function.
	Chapter 2	Specifications	Describes general specifications of Positioning function.
	Chapter 3	Before Positioning	Describes the Operation order in case of positioning operation by embedded positioning.
	Chapter 4	Positioning Check	Describes parameter and operation data to be set by software package with embedded positioning.
	Chapter 5	Positioning Instructions	

3. Positioning	Chapter 6	Introduction to Positioning Monitoring Package	Describes Positioning Monitoring Package
	Chapter 7	Program Examples of Programming	Describes Examples of Programming
	Chapter 8	Troubleshooting Procedure	Describes errors and Troubleshooting
	Chapter 9	Positioning Instruction and K area List	Describes the Operation order in case of positioning operation by embedded positioning.
	Chapter 10	Motor Wiring Example	Describes wiring examples.
4. Communications	Chapter 1	Built-in FEnet Communication	Describes Ethernet communications.
	Chapter 2	Built-in Cnet Communication	Describes serial(232/485) communications.

## 1.2 Features

The features of XGB system are as follows.

### 1.2.1 Advanced Performances

#### (1) Rapid Processing Speed

The processing speed has been improved up to more than 75% compared to the existing XBM PLC.

Items	XBM 'S' Type	XBM 'H' Type	Remarks
Sequence command	160 ns	60 ns	Based on MLOAD command
Data command	3.52 $\mu$ s	1.51 $\mu$ s	Based on MOV command
Real	10.3 $\mu$ s	2.6 $\mu$ s	RADD command
	10.6 $\mu$ s	2.6 $\mu$ s	RMUL command
Long Real	11.8 $\mu$ s	5.0 $\mu$ s	LADD command
	16.9 $\mu$ s	5.2 $\mu$ s	LMUL command

#### (3) Advanced functions

- Built-in 10/100 BASE-TX Ethernet(max 16 channel P2P service)
- provide EtherCAT expansion module

#### (4) Permanent data back up : permanent data back up is available by implementing MRAM.

### 1.2.2 Flexibility of System Configuration

- (1) The small and medium-sized system can be established, which controls up to 256 points I/O through 7-stage expansion.
- (2) Compact size  
Compared to the existing XGB basic unit, this product has various embedded functions to enhance functionality and has a reduced size so you can install it even in a small space. (Unit : mm)

Type	Model	Size (W * H * D)	Remarks
Basic unit	XBM-DN32H	42 * 90 * 64	
	XBF-,XBE-,XBL-	20* 90 * 60	Based on minimum size

- (3) Securing compatibility of the existing expansion/special/communication module  
All types of the existing XGB expansion/special/communication modules are available.
- (4) Expanding the applications through various expansion modules
  - It provides 8 points, 16 points, 32 points module I/O expansion module (In the case of relay output, 8/16 points module) with single input, single output, mixed I/O module.
  - It supports various special modules such as positioning, high-speed counter, analog I/O, temperature input, temperature control.
  - It provides various communication I/F modules such as Cnet, FEnet, RAPIEnet, CANOpen, Profibus-DP, DeviceNet.

### 1.2.3 Powerful Embedded Functions

- (1) Embedded high-speed counter function
  - The high-speed counter with up to 100kpps 4 channels(based on 1 phase 1 input 1 multiplication) is embedded.
  - Various additional functions such as comparative readout, comparative task, frequency measurement, revolutions per hour, etc. are provided.
  - Parameter setting using XG5000, various monitoring and diagnosis functions are provided.
  - You can conduct a trial run through XG5000's monitoring without the program so you can easily check of abnormalities of external wirings and data setting.
- (3) Embedded communication function
  - It has embedded Cnet 2 channels and Enet 1 channel at the same time.
  - It can communicate with other devices very easily without the special communication I/F module by using the embedded communication function.
  - It enhances convenience by providing various protocols such as dedicated communication, customization, etc.
  - You can check the communication state very easily thanks to the diagnosis function and transmitting-receiving frame monitoring function.
- (4) Embedded PID function
  - It supports the embedded PID control function up to 16 loops.
  - It provides parameter setting using XG5000, convenient loop state monitoring through trend monitor.
  - You can get the control constant easily by the improved automatic synchronization function.
  - You can improve control accuracy by using various additional functions such as PWM output,  $\Delta MV$ ,  $\Delta PV$ , SV Ramp, etc.
  - It provides various control modes such as forward/reverse mixed operation, 2-stage SV PID control, cascade control, etc.

- You can secure stability through various alarm functions such as PV MAX, PV change warning, etc.
- (5) Embedded position control function
  - The open collector output positioning function with up to 100kpps 2-axis is embedded.
  - It provides parameter setting using XG-5000 which support operation data edition, diverse monitoring and diagnosis functions.
  - You can conduct a trial run through XG-5000 monitoring without the program so you can easily check the external wirings and operation data.

### 1.2.4 Easy maintenance

- (1) Program modularize for Multi-programing and multi tasks for maintenance are available.
- (2) Built-in RTC(real time clock) function make it possible to control schedule maintenance and history.
- (3) Integrated program environment
  - Separated XG5000(ladder programming, parameter setting, monitoring ) and XG-PD(communication and network parameter setting, frame monitoring) have combined in one XG.5000. It is possible to control PLC in one programming.

## 1.3 Terminology

### 1.2.1 General term

The following table gives definition of terms used in this manual.

Terms	Definition	Remark
Module	A standard element that has a specified function which configures the system. Devices such as I/O board, which inserted onto the mother board.	Example) Expansion module, Specialmodule, Communication module
Unit	A single module or group of modules that perform an independent operation as a part of PLC systems.	Example) Main unit, Expansion unit
PLC System	A system which consists of the PLC and peripheral devices. A user program can control the system.	-
XG5000	A program and debugging tool for the MASTER-K series. It executes program creation, edit, compile and debugging. (PADT: Programming Added Debugging Tool)	-
I/O image area	Internal memory area of the CPU module which used to hold I/O status.	
Cnet	Computer Network	-
FEnet	Fast Ethernet Network	-
RAPInet	RAPInet Network	-
CANopen	Controller Area Network	-
Pnet	Profibus-DP Network	-
Dnet	DeviceNet Network	-
RTC	Abbreviation of 'Real Time Clock'. It is used to call general IC that contains clock function.	-
Watchdog Timer	Supervisors the pre-set execution times of programs and warns if a program is not completed within the pre-set time.	-

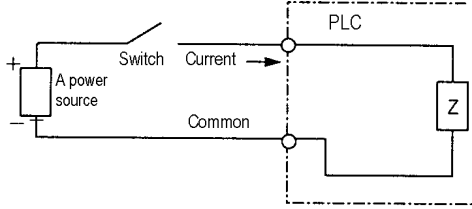
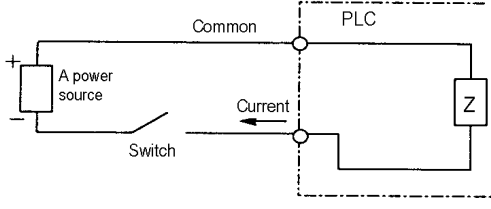
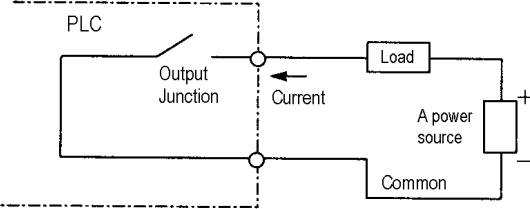
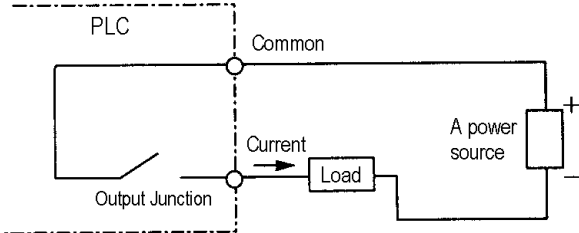

Terms	Definition	Remark
Sink Input	<p>Current flows from the switch to the PLC input terminal if a input signal turns on.</p> 	Z: Input impedance
Source Input	<p>Current flows from the PLC input terminal to the switch after a input signal turns on.</p> 	Z: Input impedance
Sink Output	<p>Current flows from the load to the output terminal and the PLC output turn on.</p> 	-
Source Output	<p>Current flows from the output terminal to the load and the PLC output turn on.</p> 	-

## 1.2.2 Serial communication term

### (1) Communication type

#### (a) Simplex

This is the communication type that data is transferred in a constant direction. Information can not be transferred in the reverse direction.

#### (b) Half-Duplex

Data is transferred in two ways with one cable if time interval provided, though it can't be transferred simultaneously.

#### (c) Full-Duplex

Data is simultaneously transferred and received in two ways with two cables.

### (2) Transmission type

#### (a) Serial transmission

This type transmits bit by bit via 1 cable. The speed of transmission is slow, but the cost of installation is low and the software is simplified.

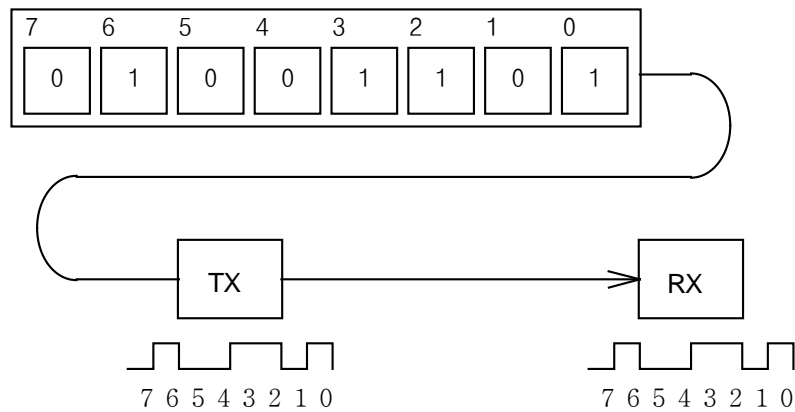

RS-232C, RS-422 and RS-485 are the examples

(b) Parallel transmission

This type is used in printer, etc., which transmits data in unit of 1 byte, so the speed is high and the accuracy of data is reliable. However, the longer the transmission distance is, the higher the cost of installation is geometrically.

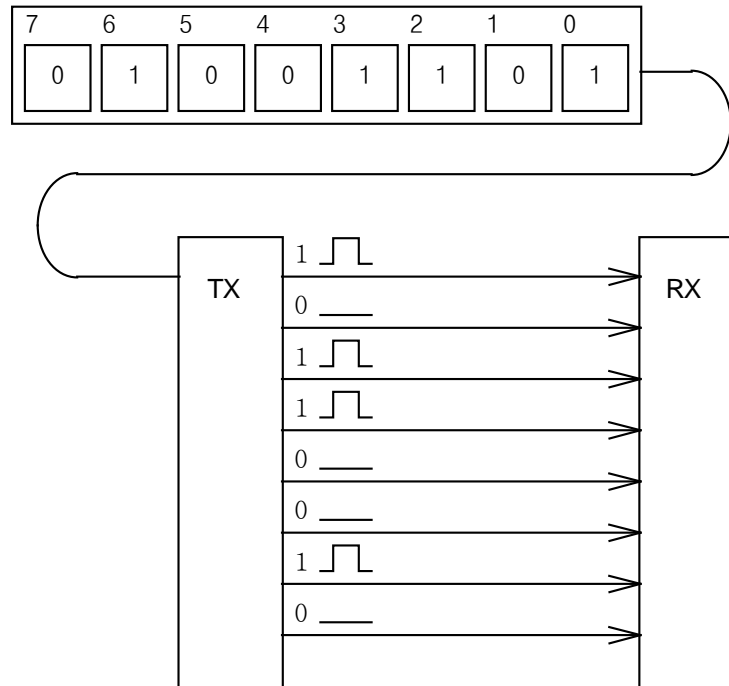

(3) Asynchronous Communication

This communication type transmits characters one by one synchronously in serial transmission. At this time, synchronous signal (Clock, etc.) is not transmitted. Character code is transmitted with a start bit attached to the head of 1 character, and it is finished with a stop bit attached to the tail.

※ For transmitting KOREA

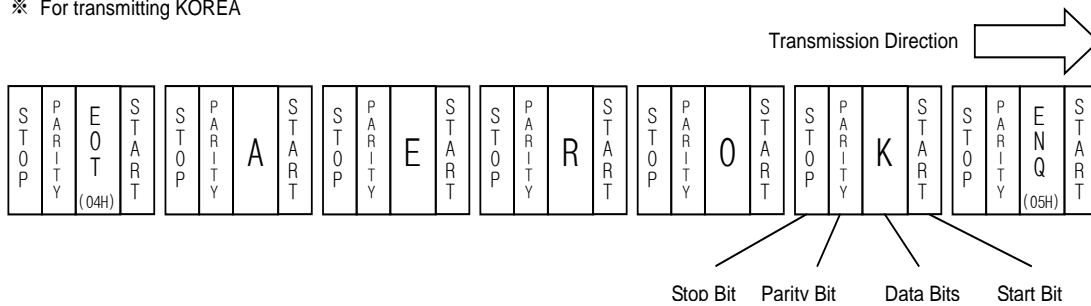

## (4) Protocol

This is communication rule established in relation between the transmission side and the receiving side of information in order to send and accept information between two computers/terminals or more without error, effectively, and reliably. In general, this specifies call establishment, connection, structure of message exchange form, re-transmission of error message, procedure of line inversion, and character synchronization between terminals, etc.

## (5) BPS(Bits Per Second)와 CPS(Characters Per Second)

BPS is a unit of transfer rate that represents how many bits are transferred per second. CPS is the number of the characters transferred for a second. Generally, one character is 1Byte (8Bits), so CPS is the number of bytes which can be transferred per second.

## (6) Node

Node is a term that means the connected nodes of the data in the network tree structure, generally network is composed of a great number of nodes, and is also expressed as the station number.

## (7) Packet

Packet, a compound term of package and bucket used for packet exchange type to send information as divided in a unit of packet, separates transferred data into the defined length to add a header that presents the correspondent addresses (station No., etc.) thereto.

## (8) Port

Port is meant to be the part of the data process device which sends or receives the data from a remote control terminal in data communications, but in Cnet serial communication is meant to be the RS-232C or RS-422 port.

## (9) RS-232C

RS-232C is the interface to link a modem with a terminal and to link a modem with a computer, and is also the serial communications specification established by EIA according to the recommendations of the CCITT. This is also used to link the null modem directly as well as the modem linkage. The disadvantage is that the transfer length is short and that only 1 : 1 communication is available, and the specifications which have overcome this disadvantage are RS-422 and RS-485.

## (10) RS-422/RS-485

As one of the serial transmission specifications, its transferring length is long with 1 : N connection available compared to RS-232C. The difference of these two specifications is that RS-422 uses 4 signals of TX(+), TX(-), RX(+) and RX(-), while RS-485 has 2 signals of (+) & (-), where data is sent and received through the same signal line. Accordingly, RS-422 executes the full-duplex type of communication and RS-485 executes the half-duplex type of communication.

## (11) Half Duplex Communication

Two-way communication is available, however simultaneous communication of transmission & receiving isn't available. This communication type is applied to RS-485 for instance. It is used a lot for multi-drop communication type which communicates via one signal line by several stations. Half Duplex Communication results from the transmission characteristic performed by stations one by one not allowing simultaneous transmission by multi stations due to the data damage of data impact caused by the simultaneous multi-transmission of the stations. The figure below shows an example of structure based on Half Duplex Communication. Each station in communication with the terminal as linked with each other can send or receive data via one line so to execute communication with all stations, where multi-sever is advantageously available.

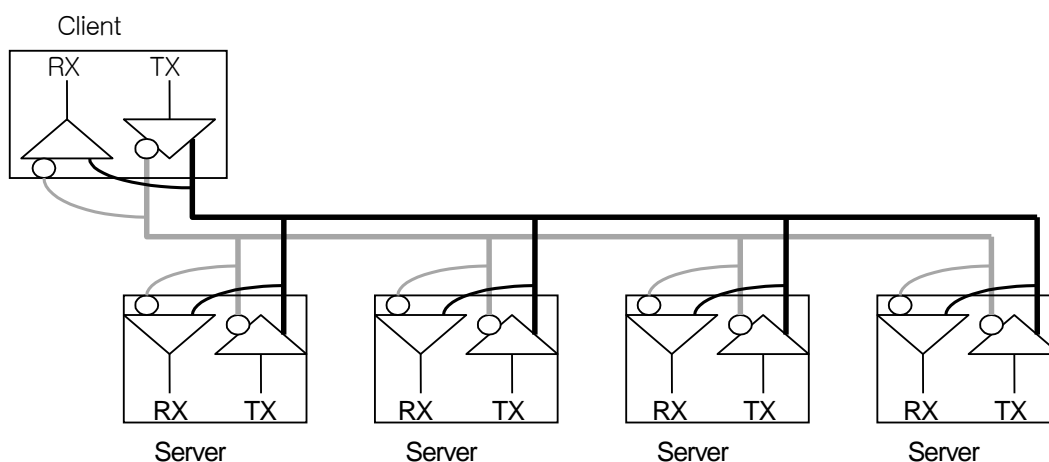

## (12) Full Duplex Communication

Two way-communications of simultaneous transmission & receiving is available. This communication type is applied to RS-232C & RS-422. Since the transmission line is separated from the receiving line, simultaneous transmission & receiving is available without data impact, so called as Full Duplex Communication. The figure shows an example of structure based on RS-422 of Full Duplex Communication. Since transmission terminal of the client station and receiving terminals of the sever stations are connected to one line, and transmission terminals of the sever stations are linked with receiving terminal of the client station, the communication between sever stations is unavailable with the restricted function of multi-sever.

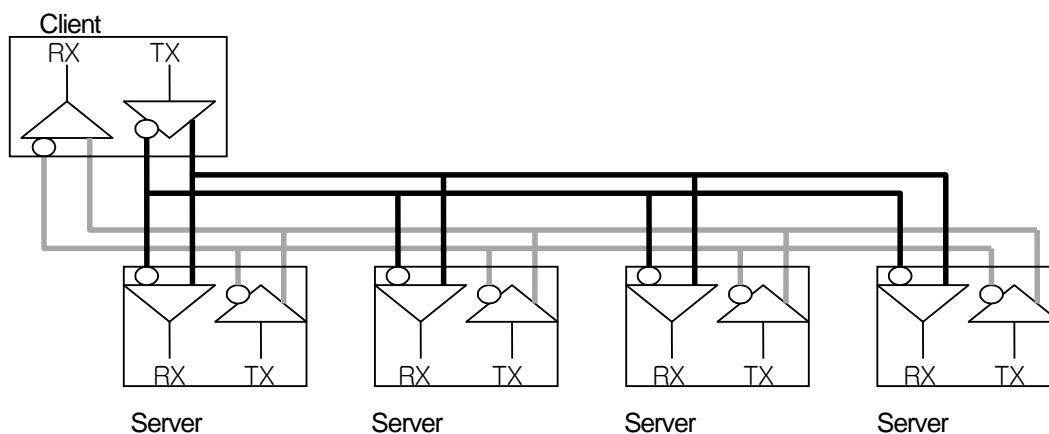

## (13) BCC (Block Check Character)

As serial transmission may have signals distorted due to undesirable noise in transmission line, BCC is used as data to help receiving side to check the signals if normal or distorted and to detect errors in signals as compared with the received BCC after calculating BCC by receiving side itself using the data input to the front terminal of BCC.

## (14) XG5000 service

This is the function to remotely perform programming, reading/writing user's program, debugging, and monitoring, etc. without moving the physical connection of XG5000 in the network system where PLC is connected to Cnet I/F module. Especially, it is convenient to control a remote PLC via modem.

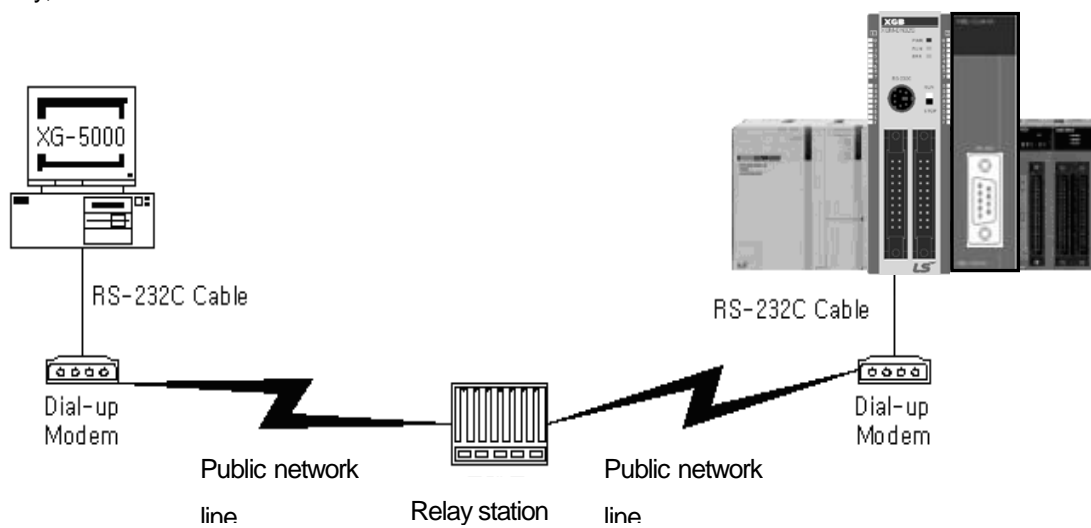

\* XG5000 : Programming software of XGT PLC for Windows

## (15) Frame

Frame is composed of transmitted and received data as in a specified form in data communication including additional information of segments [station No., command, parameter by command], control characters [ENQ, ACK, EOT, ETX] for synchronization, parity for detecting error, and BCC. The structure of frame used for serial communication of Cnet is as follows.

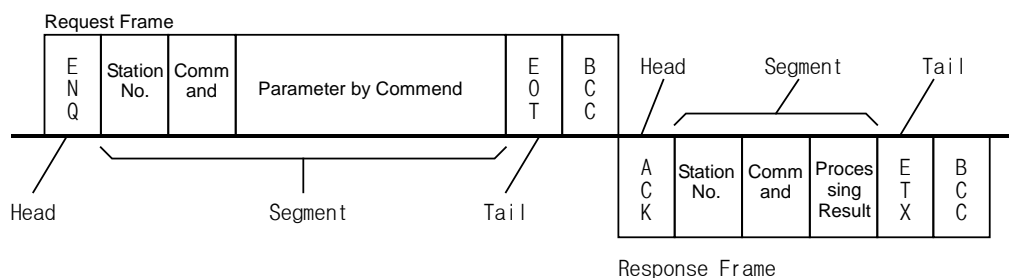

[Structure of general Tx/Rx frame]

- Head: ASCII value indicating frame start.
- Tail: ASCII value indicating frame end.
- BCC (Block Check Character)
  - ◆ Check data for Tx/Rx frame
  - ◆ Used to inspect reliability of data with such various methods as ADD, OR, Exclusive OR, MULTPLY, etc

## (16) Reset

This function is used to initialize the communication module with errors.

Use XG-PD to select [On-Line] → [Reset] so to execute Reset, which will restart PLC.

### 1.2.3 Ethernet term

This chapter describes about the general terminology of FEnet I/F module. For more detail, refer to professional book on the Ethernet

#### (1) IEEE 802.3

IEEE 802.3 specifies standards for CSMA/CD based Ethernet. Exactly it is a LAN based on CSMA/CD (Carrier Sense Multiple Access with Collision Detection) Ethernet designed by IEEE 802.3 group, which is classified into detailed projects as specified below;

- A) IEEE P802.3 - 10G Base T study Group
- B) IEEE P802.3ah - Ethernet in the First Mile Task Force
- C) IEEE P802.3ak - 10G Base-CX4 Task Force

※ Ethernet and IEEE 802.3 are standardized at RFC894 and RFC1042 so each should process another frame.

#### (2) ARP (Address Resolution Protocol)

Protocol to search for MAC address by means of correspondent IP address on the Ethernet LAN

#### (3) Bridge

A device used to connect two networks so to be operated as one network. Bridge is used not only to connect two different types of networks but also to divide one big network into two small networks in order to increase the performance

#### (4) Client

A user of the network service, or a computer or program (mainly the one requesting services) using other computer's resource.

#### (5) CSMA/CD(Carrier Sense Multiple Access with Collision Detection)

Each client checks if there is any sign prior to transmission of data to the network (Carrier Sense) and then sends its data when the network is empty. At this time, all the clients have the equal right to send (Multiple Access). If two or more clients send data, collision may occur. The client who detects the collision tries to send again in a specific time.

#### (6) DNS (Domain Name System)

A method used to convert alphabetic Domain Name on the Internet to its identical Internet number (namely, IP address)

#### (7) Dot Address

Shows IP address of '100.100.100.100', where each figure is displayed in decimal with 1 byte occupied respectively for 4 bytes in total.



### (8) E-mail Address

The address of the user with login account for the specific machine connected via the Internet. Usually user's ID @ domain name (machine name) is assigned. In other words, it will be like hjjee@microsoft.com, where @ is called as 'at' displayed with shift+2 pressed on the keyboard. The letters at the back of @ are for the domain name of specific company (school, institute,..) connected with the Internet, and the letters in front of @ are for the user ID registered in the machine. The last letters of the domain name are for the highest level. USA generally uses the following abbreviation as specified below, and Korea uses .kr to stand for Korea. .com : usually for companies) / .edu : usually for educational organizations such as universities. / .ac(academy) is mostly used in Korea / .gov : for governmental organizations. For example, nasa.gov is for NASA (government) / .mil : military related sites. For example, af.mil is for USA air force (military)/ .org : private organizations / .au : Australia / .uk : the United Kingdom / .ca : Canada / .kr : Korea / .jp : Japan / .fr : France / .tw : Taiwan, etc.

### (9) Ethernet

A representative LAN connection system (IEEE 802.3) developed by Xerox, Intel and DEC of America which can send about 10Mbps and use the packet of 1.5kB. Since Ethernet can allow various types of computers to be connected as one via the network, it has been called a pronoun of LAN as a universal standard with various products available, not limited to some specific companies.

### (10) FTP (File Transfer Protocol)

An application program used to transfer files between computers among application programs providing TCP/IP protocol. If an account is allowed to the computer to log in, fast log in the computer is available wherever the computer is so to copy files.

### (11) Gateway

Software/Hardware used to translate for two different protocols to work together, which is equivalent to the gateway necessary to exchange information with the different system.

### (12) Header

Part of the packet including self station number, correspondent station number and error checking area.

### (13) HTML

Hypertext Markup Language, standard language of WWW. In other words, it is a language system to prepare Hypertext documents. The document made of HTML can be viewed through the web browser

### (14) HTTP

Hypertext Transfer Protocol, standard protocol of WWW. It is a protocol supporting the hypermedia system.

### (15) ICMP (Internet Control Message Protocol)

An extended protocol of IP address used to create error messages and test packets to control the Internet.

### (16) IP (Internet Protocol)

Protocol of network layers for the Internet

**(17) IP Address**

Address of respective computers on the Internet made of figures binary of 32 bits (4 bytes) to distinguish the applicable machine on the Internet. Classified into 2 sections, network distinguishing address and host distinguishing address. The network address and the host address is respectively divided into class A, B and C based on the bits allotted. IP address since it shall be unique all over the world, shall be decided not optionally but as assigned by NIC(Network Information Center) of the applicable district when joining the Internet. In Korea, KRNIC(Korea Network Information Center) is in charge of this work. Ex.) 165.244.149.190

**(18) ISO (International Organization for Standardization)**

A subsidiary organization of UN establishing and managing the international standards

**(19) LAN (Local Area Network)**

Called also as local area communication network or district information communication network, which allows lots of computers to exchange data with each other as connected though communication cable within a limited area such as in an office or a building

**(20) MAC (Medium Access Control)**

A method used to decide which device should use the network during given time on the broadcast network

**(21) Node**

Each computer connected with the network is called Node

**(22) Packet**

A package of data which is the basic unit used to send through the network. Usually the package is made of several tens or hundreds of bytes with the header attached in front to which its destination and other necessary information are added

**(23) PORT number**

Used to classify the applications on TCP/UDP.

Ex.) 21/tcp : Telet

**(24) PPP (Point-to-Point Protocol)**

Phone communication protocol which allows packet transmission in connecting with the Internet. In other words, normal phone cable and modem can be used for the computer to connect through TCP/IP with this most general Internet protocol.

Similar to SLIP, however with modern communication protocol factors such as error detection and data compression, it demonstrates more excellent performance than SLIP.

**(25) Protocol**

Contains regulations related with mutual information transmission method between computers connected with each other through the network. The protocol may specify detailed interface between machines in Low level (for

example, which bit/byte should go out through the line) or high level of message exchange regulations as files are transferred through the Internet.

(26) Router

A device used to transfer the data packet between the networks. It sends the data packet to its final destination, waits if the network is congested, or decides which LAN is good to connect to at the LAN junction. Namely, it is a special computer/software used to control the two or more networks connected.

(27) Server

The side which passively responds to the client's request and shares its resources.

(28) TCP (Transmission Control Protocol)

A transport layer protocol for the Internet

- Data Tx/Rx through connection
- Multiplexing
- Transmission reliable
- Emergent data transmission supported

(29) TCP/IP (Transmission Control Protocol/Internet Protocol)

Transmission protocol used for communication among different kinds of computers, which makes the communication available between general PC and medium host, IBM PC and MAC, and medium or large-sized different types of computer. It is also used as a general term for information transmission protocol between computer networks including FTP, Telnet, SMTP, etc. TCP divides data into packets to send through IP and the packets sent will be united back together through TCP.

(30) Telnet

It means remote login via Internet. To login to remote host via TELNET, account of that host is necessary. But for some hosts providing public service, you can connect without account

## (31) Token Ring

As short-distance network using Token to connect to network having physical ring structure, one of the Node connection methods at network. If node sending data gets Token, then node gets right to send message packet. Realistically structured examples are IEEE 802.5, ProNet-1080 and FDDI. Terms called Token is used as IEEE 802.5

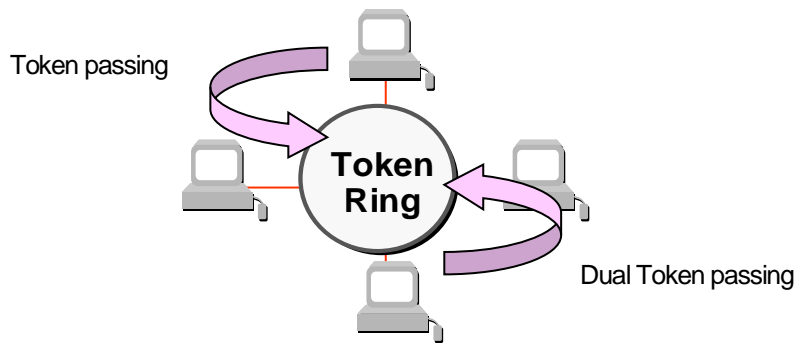

## (32) UDP(User Datagram Protocol)

A transport layer protocol for the Internet

- High speed communication because of communication without connection
- Multiplexing
- Lower reliability than TCP in transmission (Tough data doesn't arrive, it doesn't send data again)

## (33) Auto-Negotiation

Fast Ethernet is that Ethernet exchanges information like operation speed, duplex mode.

1. Detect disconnection
2. Decide the specification of network device
3. Change connection speed

## (34) FDDI (Fiber Distributed Data Interface)

Based on optical cable, provides 100Mbps, Shared Media Network as Dual Ring method, Token Passing is done in two-way.

Max 200Km distance for entire network, Max 2Km between Nodes, Max 500 nodes. Generally, this used as Backbone Network.

## (35) Reset

This is function used when you want to initialize the communication module to clear the error

Select [Online] → [Rest] in the XG-PD

If you execute this function, PLC will restart.



## Chapter 2 System Configuration

You can configure various systems by using the XBM 'H' Type basic unit and expansion · special communication I/F modules. This chapter describes how to configure the system through the XGB 'H' Type basic unit

### 2.1 Table of Products Configuration

The available configurations of for the XBM 'H' Type PLC system are as below table.

Types	Model	Description	Remark
Main Unit	XBM-DN32H	DC24V power supply, DC24V input 16 point, Transistor output 16 point(sink)	Basic type
Expansion Unit	XBE-DC08A	DC24V Input 8 point	Input
	XBE-DC16A/B	DC24V Input 16 point	
	XBE-DC32A	DC24V Input 32 point	
	XBE-RY08A	Relay output 8 point	Output
	XBE-RY08B	Relay output 8 point(isolated ouput)	
	XBE-RY16A	Relay output 16 point	
	XBE-TN08A	Transistor output 8 point (sink type)	
	XBE-TN16A	Transistor output 16 point (sink type)	
	XBE-TN32A	Transistor output 32 point (sink type)	
	XBE-TP08A	Transistor output 8 point (source type)	
	XBE-TP16A	Transistor output 16 point (source type)	
	XBE-TP32A	Transistor output 32 point (source type)	
	XBE-DR16A	DC24V Input 8 point, Relay output 8 point	
	XBE-DN32A	DC24V Input 8 point, Transistor output 16 point (sink type)	
Special Module	XBF-AD04A	Current/Voltage input 4 channel, 1/4000 resolution	Analog In/Out
	XBF-AD04C	Current/Voltage input 4 channell, 1/16000 resolution	
	XBF-AD08A	Current/Voltage input 8 channel, 1/4000 resolution	
	XBF-DC04A	Current output 4 channell, 1/4000 resolution	
	XBF-DC04C	Current output 4 channel, High resolutionl, 1/16000 resolution	
	XBF-DV04A	Voltage output 4 channell, 1/4000 resolution	
	XBF-DV04C	Voltage output 4 channel, 1/16000 resolution	
	XBF-AH04A	Current/Voltage input 2 channel, Current/Voltage output 2 channel, 1/4000 resolution	
Special Module	XBF-RD04A	RTD (Resistance Temperature Detector) input 4 channel, Pt100, Jpt100	Temperature
	XBF-RD01A	RTD (Resistance Temperature Detector) input 1 channel, Pt100, Jpt100	
	XBF-TC04S	TC (Thermocouple) input 4 channel	
	XBF-PD02A	Position 2Axis, Line Drive type, Max 2Mpps	Positioning
	XBF-HD02A	High Speed Counter 2 channel, Line Drive Type	Counter
	XBF-HO02A	High Speed Counter 2 channel, Open Collector Type	
	XBF-TC04RT	Temperature controller module (RTD input, 4 roof)	
	XBF-TC04TT	Temperature controller module (TC input, 4 roof)	
	XBF-PN08B	Network position (Open type Ethercat ) 8 Axis	

Types	Model	Description	Remark
Communication Module	XBL-C21A	Cnet (RS-232C/Modem) I/F	-
	XBL-C41A	Cnet (RS-422/485) I/F	-
	XBL-EMTA	Enet I/F	-
	XBL-EIMT/F/H	RAPIEnet I/F 2 UTP cable	-
	XBL-EIPT	EtherNet I/P Module	-
	XBL-CMEA	CANopen Master I/F	-
	XBL-CSEA	CANopen Slave I/F	-
	XBL-PMEC	Profibus-DP, Master	-
	XBL-PSEA	Profibus-DP, Slave	
	XBL-DSEA	DeviceNet, Slave	
	USB-301A	Connection cable (PC to PLC), USB	--

**Notice**

LS INDUSTRIAL SYSTEM CO., LTD. has consistently developed and launched new products.  
For new products that are not included to this manual, please contact a nearby exclusive agency.

## 2.2 Classification and Type of Product Name

### 2.2.1 Classification and type of basic unit

Name of basic unit is classified as follows.

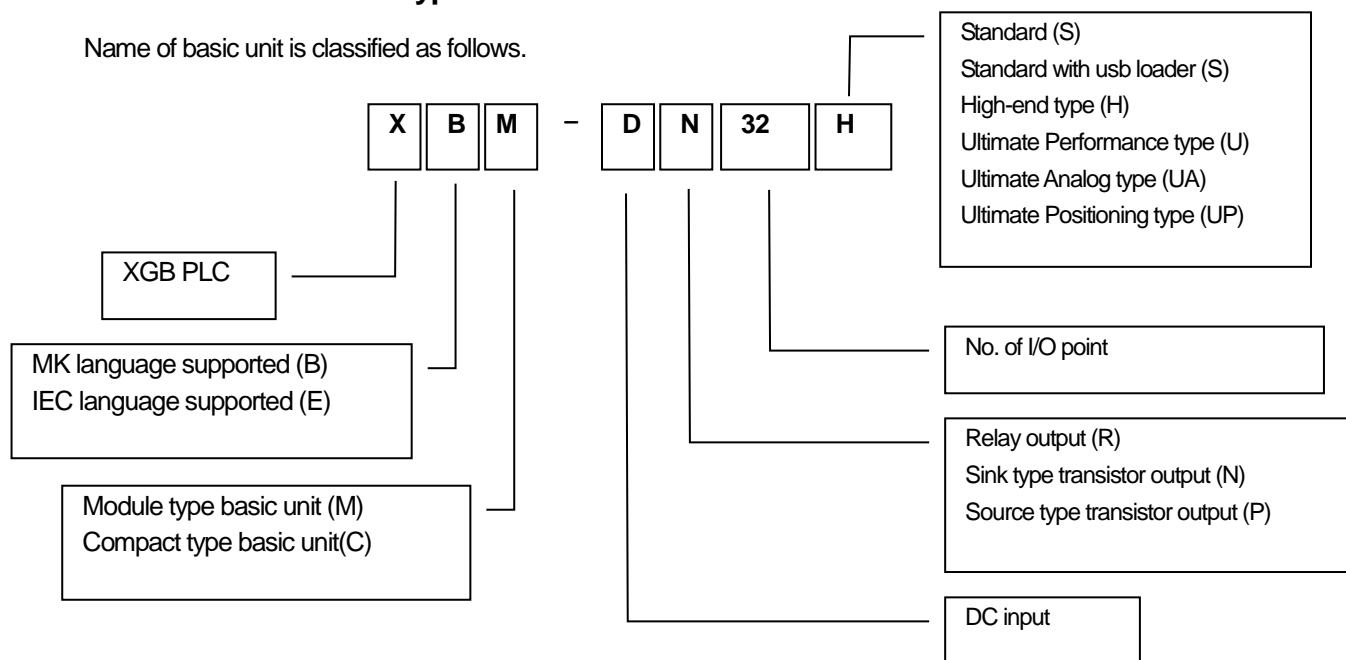

Classification	Name	DC input	Relay output	Transistor output	Power
Main unit	XBM-DR16S	8 point	8point	None	DC24V
	XBM-DN16S	8point	None	8point	
	XBM-DN32S	16 point	None	16 point	
	XBM-DN32H	16 point	None	16 point	
	XBC-DR32H	16 point	16 point	None	
	XBC-DN32H	16 point	None	16 point	
	XBC-DR64H	32 point	32 point	None	
	XBC-DN64H	32 point	None	32 point	
	XBC-DN20S(U)	12 point	None	8 point	AC110V-220V
	XBC-DN30S(U)	18 point	None	12 point	
	XBC-DN40SU	24 point	None	16 point	
	XBC-DN60SU	36 point	None	24 point	
	XBC-DR20SU	12 point	8 point	None	
	XBC-DR30SU	18 point	12 point	None	
	XBC-DR40SU	24 point	16 point	None	
	XBC-DR60SU	36 point	24 point	None	
	XBC-DR10E	6 point	4 point	None	
	XBC-DR14E	8 point	6 point	None	
XBC-DR20E	12 point	8 point	None		



Classification	Name	DC input	Relay output	Transistor output	Power
Main unit	XBC-DR30E	18 point	12 point	None	AC110V-220V
	XBC-DN10E	6 point	None	4 point	
	XBC-DN14E	8 point	None	6 point	
	XBC-DN20E	12 point	None	8 point	
	XBC-DN30E	18 point	None	12 point	
	XBC-DP10E	6 point	None	4 point	
	XBC-DP14E	8 point	None	6 point	
	XBC-DP20E	12 point	None	8 point	
	XBC-DP30E	18 point	None	12 point	
	XBC-DR40EB	24 point	16 point	None	
	XBC-DR60EB	36 point	24 point	None	
	XBC-DR40EX	24 point	16 point	None	
	XBC-DR60EX	36 point	24 point	None	
	XBC-DN32U	16 point	None	16 point	
	XBC-DP32U	16 point	None	16 point	
	XBC-DR28U	16 point	12 point	None	
	XBC-DN32UP	16 point	None	16 point	
	XBC-DP32UP	16 point	None	16 point	
	XBC-DR28UP	16 point	12 point	None	
	XBC-DN32UA	16 point	None	16 point	
	XBC-DP32UA	16 point	None	16 point	
	XBC-DR28UA	16 point	12 point	None	
	XBC-DN32U/DC	16 point	None	16 point	DC24V
	XBC-DP32U/DC	16 point	None	16 point	
	XBC-DR28U/DC	16 point	12 point	None	
	XBC-DN32UP/DC	16 point	None	16 point	
	XBC-DP32UP/DC	16 point	None	16 point	
	XBC-DR28UP/DC	16 point	12 point	None	
	XBC-DN32UA/DC	16 point	None	16 point	
	XBC-DP32UA/DC	16 point	None	16 point	
	XBC-DR28UA/DC	16 point	12 point	None	

### 2.2.2 Classification and type of expansion module

Name of expansion module is classified as follows.

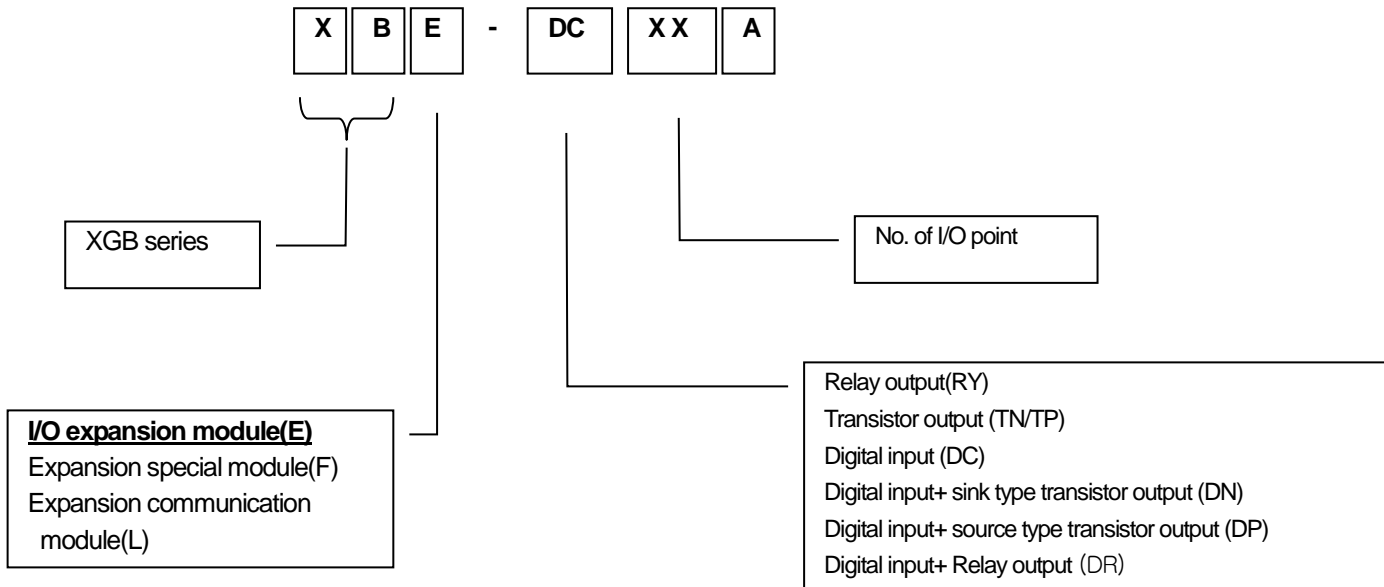

Name	DC input	Relay output	Transistor output	Reference
XBE-DC08A	8 point	None	None	Input
XBE-DC16A/B	16 point	None	None	
XBE-DC32A	32 point	None	None	
XBE-RY08A/B	None	8 point	None	Relay Output
XBE-RY16A	None	16 point	None	
XBE-TN08A	None	None	8 point (sink type)	Sink type Output
XBE-TN16A	None	None	16 point (sink type)	
XBE-TN32A	None	None	32 point (sink type)	
XBE-TP08A	None	None	8 point (source type)	Source type Output
XBE-TP16A	None	None	16 point (source type)	
XBE-TP32A	None	None	32 point (source type)	
XBE-DR16A	8 point	8 point	None	In/Output
XBE-DN32A	16 point	None	16 point (sink type)	

### 2.2.3 Classification and type of special module

Special module is classified as follows.

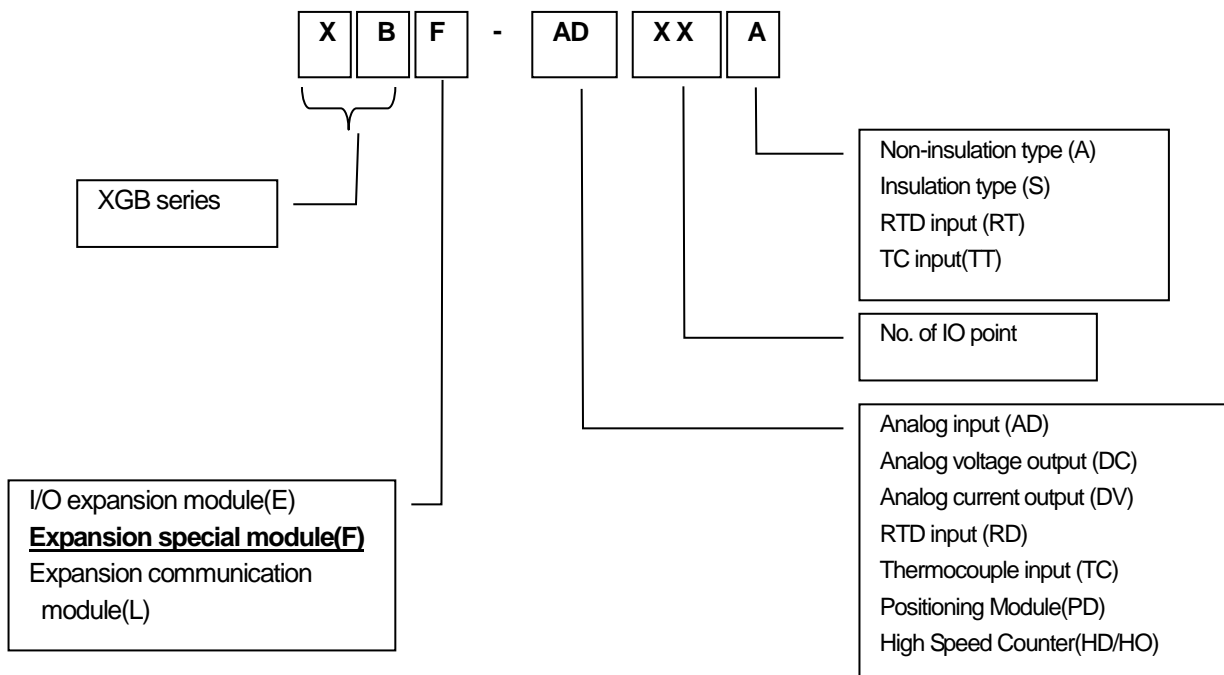

Classification	Name	No. of input ch.	Input type	No. of output ch.	Output type
Analog input	XBF-AD04A/C	4	Voltage/Current	None	-
	XBF-AD08A	8	Voltage/Current	None	-
Analog output	XBF-DC04A/C	None	-	4	Current
	XBF-DV04A/C	None	-	4	Voltage
RTD input	XBF-RD04A	4	PT100/JPT100	None	-
	XBF-RD01A	1	PT100/JPT100	None	-
TC input	XBF-TC04S	4	K, J, T, R	None	-
	XBF-TC04RT	4	PT100/JPT100	4	Transister
	XBF-TC04TT	4	K, J, T, R	4	Transister
Positioning	XBF-PD02A	-	Line Driver	2	Voltage
	XBF-PN08B	-	Line Driver	8	EtherCAT
High Speed Counter	XBF-HD02A	2	Line Driver	-	Voltage
	XBF-HO02A	2	Open Collector	-	Voltage

## 2.2.4 Classification and type of communication module

Name of communication module is classified as follows.

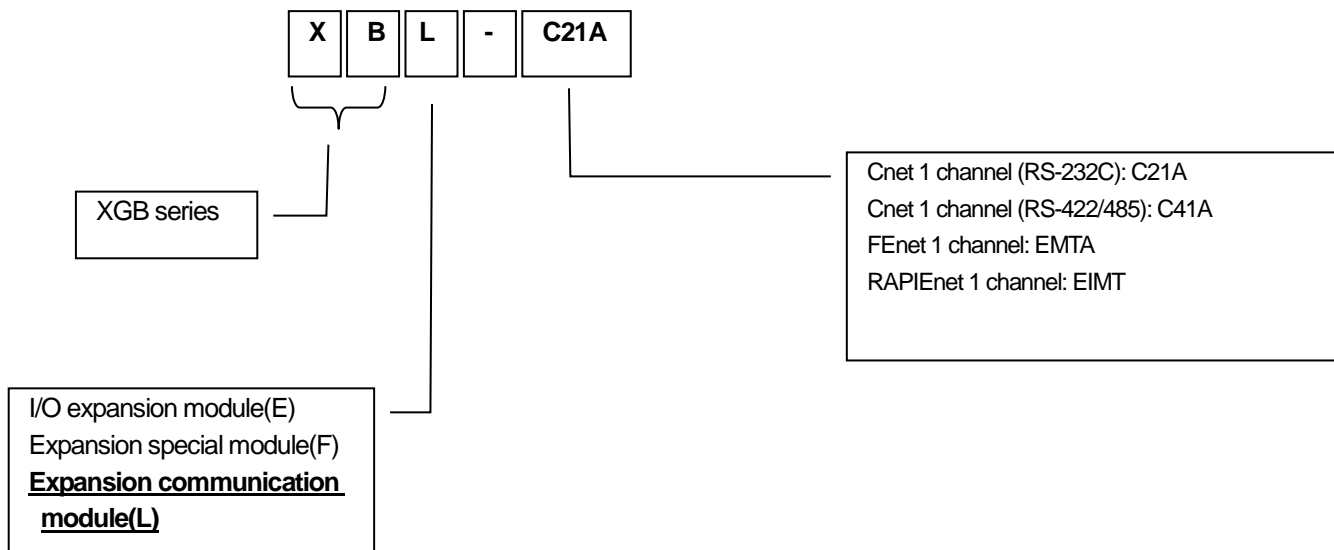

Classification	Name	Type
Cnet Comm. Module	XBL-C21A	RS-232C, 1 channel
	XBL-C41A	RS-422/485, 1 channel
FEnet Comm. Module	XBL-EMTA	Electricity, open type Ethernet
RAPIEnet Comm. Module	XBL-EIMT/EIMF/EIMH	Comm. Module between PLCs, electric media, 100 Mbps industrial Ethernet supported
EtherNet Comm. Module	XBL-EIPT	Open EtherNet I/P
CANopen Comm. Module	XBL-CMEA	CANopen Master
	XBL-CSEA	CANopen Slave
Pnet Comm. Module	XBL-PMEC	Profibus-DP Master
	XBL-PSEA	Profibus-DP Slave
DeviceNet Comm. Module	XBL-DSEA	DeviceNet Slave

## 2.3 XBM 'H' Type's System Configuration

### 2.3.1 How to configure the System

You can configure the system by using the XBM 'H' Type PLC as below.

You can connect to the expansion modules up to 7EA.

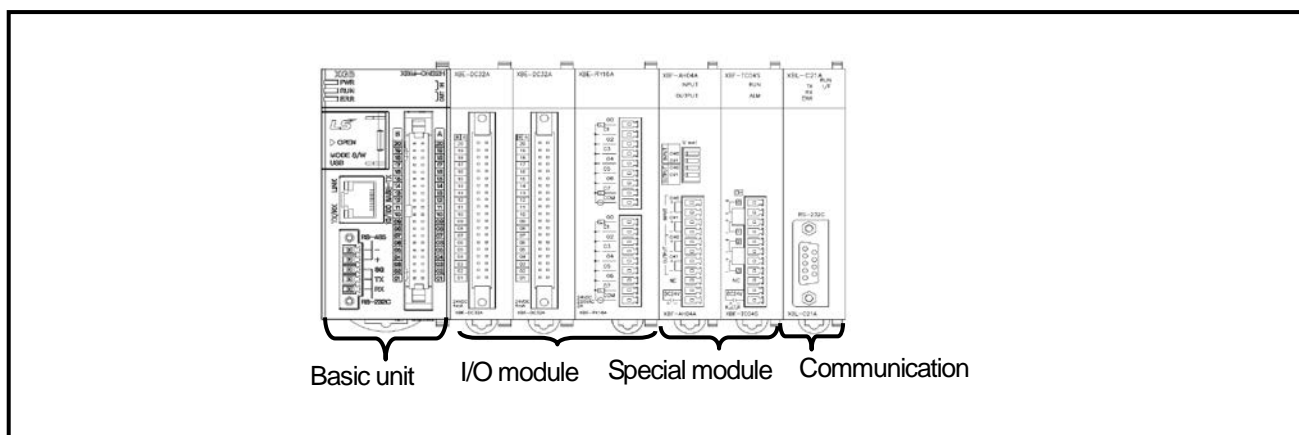

Items		Description				
Number of I/O configuration points		<ul style="list-style-type: none"> <li>• XBC-DN32H : 32 points~256 points</li> </ul>				
Number of accessible expansion modules	Digital I/O module	<ul style="list-style-type: none"> <li>• Up to 7 EA</li> </ul>				
	Special module	<ul style="list-style-type: none"> <li>• Up to 7 EA</li> </ul>				
	Communication module	<ul style="list-style-type: none"> <li>• Up to 2 EA</li> </ul>				
	High speed expansion module	<ul style="list-style-type: none"> <li>• Up to 2 EA (Can be expanded for 2 slots just behind the basic unit)</li> </ul>				
	Option module	<ul style="list-style-type: none"> <li>• Cannot be installed.</li> </ul>				
Configuration of products	Main Unit	XBM series	<ul style="list-style-type: none"> <li>• XBM-DN16S</li> <li>• XBM-DN32H</li> </ul>	<ul style="list-style-type: none"> <li>• XBM-DR16S</li> </ul>	<ul style="list-style-type: none"> <li>• XBM-DN32S</li> </ul>	
	Expansion module	Digital I/O module	<ul style="list-style-type: none"> <li>• XBE-DC08/16/32A</li> <li>• XBE-DC16B</li> <li>• XBE-DR16A</li> </ul>	<ul style="list-style-type: none"> <li>• XBE-TN08/16/32A</li> <li>• XBE-TP08/16/32A</li> <li>• XBE-DN32A</li> </ul>	<ul style="list-style-type: none"> <li>• XBE-RY08/16A</li> <li>• XBE-RY08B</li> </ul>	
		Special module	<ul style="list-style-type: none"> <li>• XBF-AD04A</li> <li>• XBF-AD04C</li> <li>• XBF-AD08A</li> <li>• XBF-AH04A</li> <li>• XBF-RD04A</li> <li>• XBF-RD01A</li> </ul>	<ul style="list-style-type: none"> <li>• XBF-DC04A</li> <li>• XBF-DC04C</li> <li>• XBF-DV04A</li> <li>• XBF-DV04C</li> <li>• XBF-TC04S</li> <li>• XBF-PD02A</li> </ul>	<ul style="list-style-type: none"> <li>• XBF-HO02A</li> <li>• XBF-HD02A</li> <li>• XBF-TC04RT</li> <li>• XBF-TC04TT</li> <li>• XBF-LD02S</li> </ul>	
		Communication module	<ul style="list-style-type: none"> <li>• XBL-C41A</li> <li>• XBL-EMTA</li> <li>• XBL-PMEC</li> </ul>	<ul style="list-style-type: none"> <li>• XBL-C21A</li> <li>• XBL-EIMT/F/H</li> <li>• XBL-EIPT</li> </ul>	<ul style="list-style-type: none"> <li>• XBL-PSEA</li> <li>• XBL-CMEA/CSEA</li> <li>• XBL-DSEA</li> </ul>	
		High speed I/F module	<ul style="list-style-type: none"> <li>• XBF-PN04B</li> </ul>	<ul style="list-style-type: none"> <li>• XBF-PN08B</li> </ul>		

### 2.3.2 Instructions for System Configuration

#### (1) High speed expansion module

XBM 'H' type PLC supports high-speed expansion I/F to speed up expansion module processing.

This section explains the precautions when configuring the system using the high-speed expansion module and the general expansion module.

- There are two types of high-speed expansion modules using high-speed expansion I/F: XBF-PN04B and XBF-PN08B.
- XBM 'H' type can use both general and high-speed expansion modules.
- The high-speed expansion module can be installed only in the 2nd or 3rd slot.
- If the high-speed expansion module is installed in the 3rd slot, the high-speed expansion module must be present in the 2nd slot as well.
- High-speed expansion module cannot be installed behind general expansion module. Therefore, the high-speed expansion module and the general expansion module In case of mixed use, the general expansion module must be installed behind the high-speed expansion module.
- Expansion communication module can be installed up to 2 units as before.
- The table below shows an example of system configuration when using a high-speed expansion module and a general expansion module.

(◇ : General expansion module (Special, I/O), ◎ : General expansion module (Communication), ◆ : High speed expansion modules)

Basic Unit	Slot Number					Definitions of Operations	Remarks
	No.1	No.2	No.3	No.4	No.6~8		
XBM-H Type	◆	◆	◎	◎	◇	Slots 2 and 3: high-speed expansion module, slots 3~8: general expansion module	2 communication modules works
	◆	◎	◎	◇	◇	Slots 2 and 3: high-speed expansion module, slots 3~8: general expansion module	2 communication modules works
	◇	◆	◎	◇	◇	Not configurable e (Cannot use high-speed expansion module after general expansion module)	
	◆	◆	◆	◇	◇	Not configurable (exceeds the allowable number of high-speed expansion modules)	
	◎	◎	◎	◇	◇	Not configurable (exceeds the allowable number of communication modules)	
	◇	◇	◎	◎	◇	Consists of only general expansion modules	2 communication modules works
Existing XGB	◎	◎	◇	◇	◇	Consists of only general expansion modules	2 communication modules works
	◎	◎	◎	◇	◇	Not configurable (exceeds the allowable number of communication modules)	
	◆	◎	◎	◇	◇	Not configurable (high-speed expansion module is not supported)	

## (2) How to allocate slots for expansion modules

-In the case of the XBM 'H', built-in Ethernet occupies No.1 slot. Accordingly, No.2 slot is allocated for the first expansion module.

-In the case of the XBM 'H' type, empty slot is allocated for No.1.

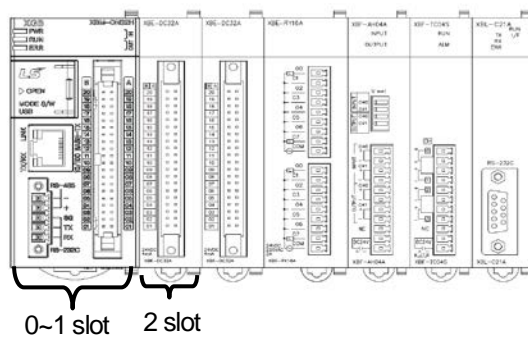

### 2.3.3 Embedded Communication System Configuration

#### 2.3.3.1 Embedded Cnet I/F System Configuration

The Cnet I/F system is the system to transmit/receive external devices including PC and data through RS-232C/RS-422 I/F. In the case of the high performance XGB PLC, RS-232C and RS-485 communication I/F are respectively embedded. Moreover, you can additionally install the Cnet I/F module (XBL-C21A) for RS-232C only that is the expansion module and Cnet I/F module (XBL-C41A) for 485 only so it is possible to build up various communication systems for the purposes.

Some examples of communication systems are represented here, which can be configured by the Cnet I/F embedded in the high performance XGB basic unit.

(1) 1:1 connection with the HMI by using the basic unit's embedded RS-232C or RS-485 port

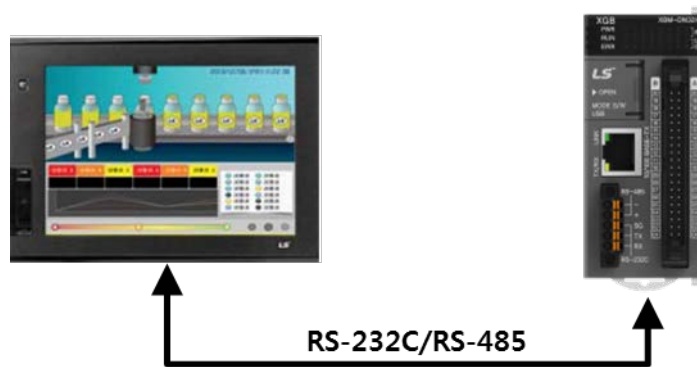

(2) Communication with the other PLC through the basic unit's embedded RS-485 port/ 1:1 connection with the HMI through the embedded RS-232C port

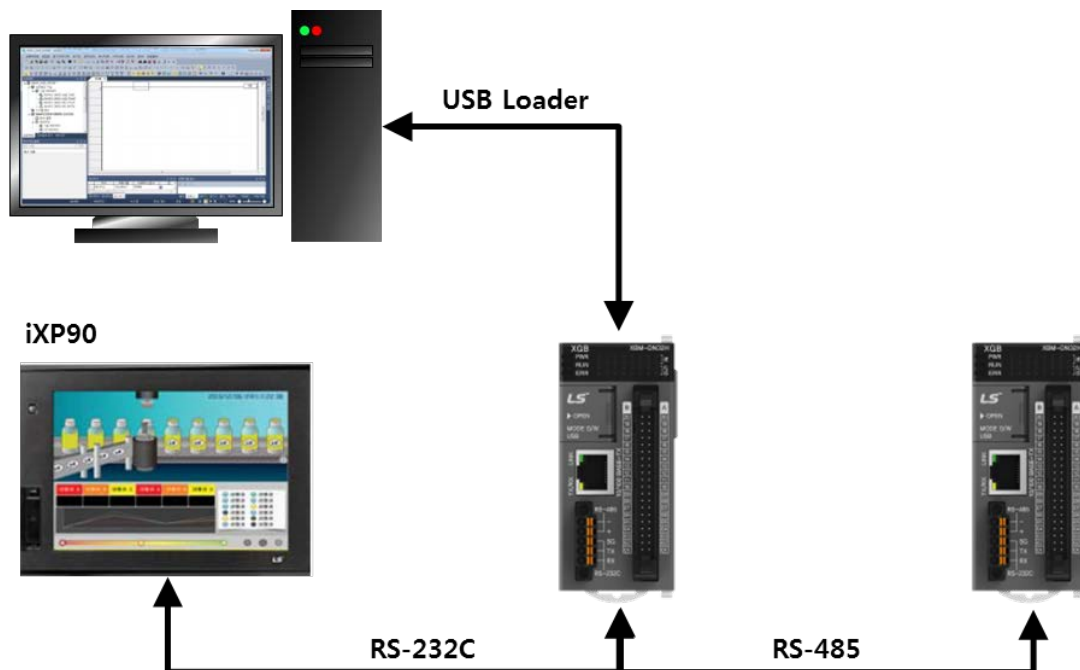

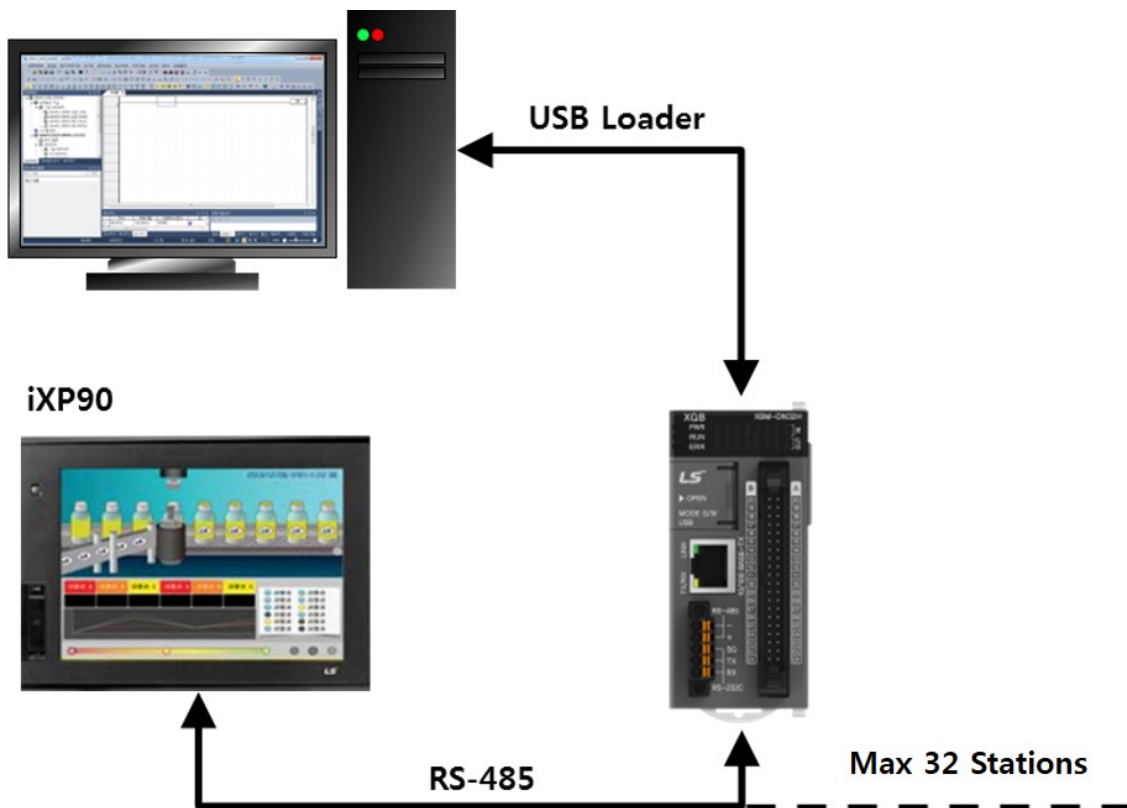

(3) Configuring 1:N communication system with the maximum 32 stations by using the basic unit's embedded RS-485 port

**Notice**

For detailed specifications of the high performance XGB's embedded Cnet communication, refer to Chap.4 Embedded Communication of this manual.

For detailed specifications of the expansion Cnet communication module, refer to "XGB Cnet I/F" of the manual.

### 2.3.3.2 Embedded Ethernet I/F System Configuration

The Ethernet is the typical LAN interface (IEEE802.3) developed commonly by Xerox, Intel, DEC of U.S.A. It is the network connection system with the transfer capacity of 100Mbps and packets of 1.5kB. The Ethernet can integrate different types of computers through network so it is regarded as the representative LAN interface. It is not the standard for a specific company but the common standard so you can find various products. In addition, it can control communication through CSMA/CD and builds up the network easily, furthermore, can collect high-capacity data.

(1) Ethernet system's block diagram

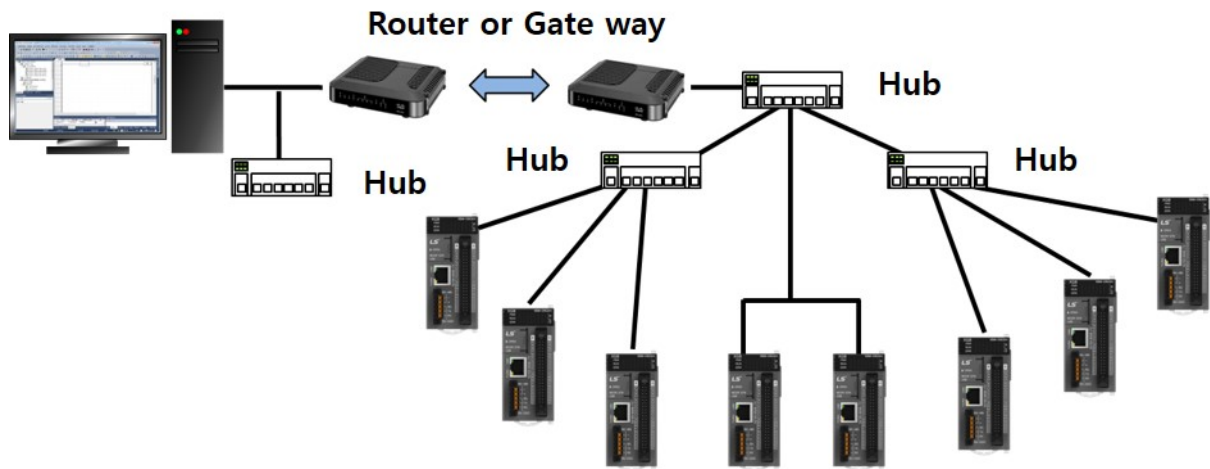

#### Notice

For more details on how to the above LS ELECTRIC's network system configuration and Enet system configuration, refer to Chap.5 Embedded Communication and "XGB FEnet I/F" of this manual.



## Chapter 3 Specifications

### 3.1 Names and Functions of Each Part

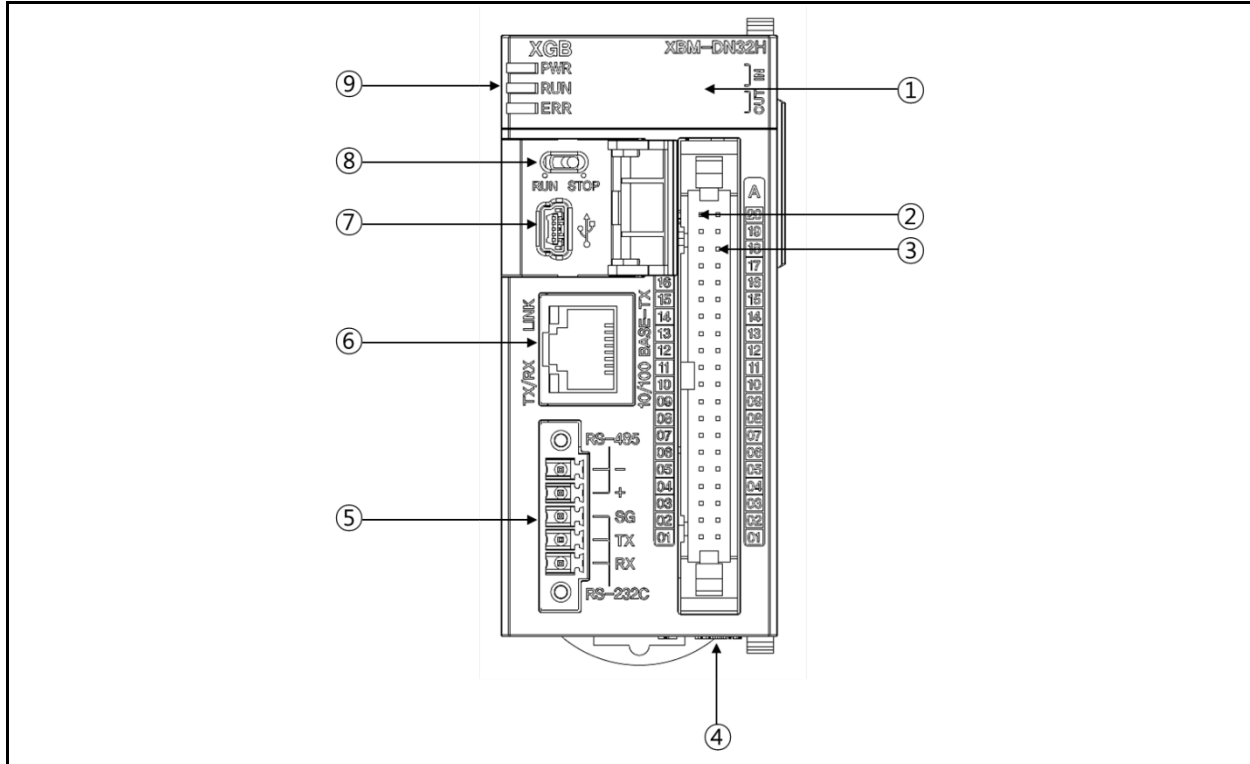

No	Names	Purposes
①	LED for displaying input, output	■ Displays the On/Off status of input, output contacts
②	I/O Connector	Input points ■ Terminal block receiving the actual input signal
③		Output points ■ Terminal block outputting the actual output signal
④	Power supply connector	■ Power supply connector (24V)
⑤	Built-in serial communication connecting connector	■ Built-in RS-232C/485 connecting connector
⑥	Built-in ethernet connecting connector	■ Built-in Enet connecting connector
⑦	PADT connecting connector	■ PADT connecting connector
⑧	RUN/STOP mode switch	■ Sets the basic unit's operation mode. <ul style="list-style-type: none"> <li>• STOP → RUN : Program's operation is executed.</li> <li>• RUN → STOP : Program's operation is stopped. (In case of STOP, the remote operation is available.)</li> </ul>
⑨	Status display LED	■ Displays the basic unit's operation status. <ul style="list-style-type: none"> <li>• PWR(Red light On) : The power is supplied.</li> <li>• RUN(Green light On) : During RUN mode</li> <li>• ERR(Flickering red light) : Occurrence of errors during operation</li> <li>• STATE(Red light On/flickering Red light): When the SD card is installed, the red light is turned On; when the SD card error occurs, the red light is flickering.</li> <li>• RDWR(Flickering red light) : During SD card Write</li> </ul>

### 3.2 General specifications

No.	Items	Specification	Reference		
1	Ambient Temp.	0 ~ 55 °C	-		
2	Storage Temp.	-25 ~ +70 °C			
3	Ambient humidity	5 ~ 95%RH (Non-condensing)			
4	Storage humidity	5 ~ 95%RH (Non-condensing)			
5	Vibration	Occasional vibration		-	
		Frequency	Acceleration	Pulse width	10 times each direction (X,Y and Z)
		5≤f< 8.4Hz	-	3.5mm	
		8.4≤f≤150Hz	9.8m/s <sup>2</sup> (1G)	-	
		Continuous vibration			
		Frequency	Acceleration	Pulse width	
		5≤f< 8.4Hz	-	1.75mm	
	8.4≤f≤150Hz	4.9m/s <sup>2</sup> (0.5G)	-		
6	Shocks	<ul style="list-style-type: none"> <li>• Peak acceleration : 147 m/s<sup>2</sup>(15G)</li> <li>• Duration : 11ms</li> <li>• Pulse wave type : Half-sine (3 times each direction per each axis)</li> </ul>		IEC61131-2	
7	Impulse noise	Square wave impulse noise	AC: ±1,500 V DC: ±900 V		
		Electrostatic discharge	Voltage: 4kV (Contact discharge)		
		Radiated electromagnetic field noise	80 ~ 1,000MHz, 10 V/m		
		Fast transient /Burst noise	Classifi- cation	Power supply	Digital/Analog Input/Output, Communication Interface
Voltage	2kV		1kV		
8	Operation ambience	Free from corrosive gases and excessive dust		-	
9	Altitude	Less than 2,000m			
10	Pollution degree	Less than 2			
11	Cooling method	Air-cooling			

#### Notes

##### 1) IEC (International Electrotechnical Commission)

: An international civil community that promotes international cooperation for standardization of electric/ electro technology, publishes international standard and operates suitability assessment system related to the above.

##### 2) Pollution Degree

: An index to indicate the pollution degree of used environment that determines the insulation performance of the device. For example, pollution degree 2 means the state to occur the pollution of non-electric conductivity generally, but the state to occur temporary electric conduction according to the formation of dew.

### 3.3 Power specifications

This section describes the high performance XGB PLC basic unit's power specifications.

Items		Specification	condition
Input	Input volatage range	DC19.2~28.8V(-15%, + 20%)	-15%, + 20% of rated voltage
	Rated input voltage	DC24V	
	Input current	1A or less	Input max +DC28.8V load
	Inrush current	70 Apeak or less	Input max +DC28.8V load
	Efficiency	60% or more	Input max +DC28.8V load
	Permitted momentary power failure	1ms or less	Input max +DC28.8V load
Ouput	Rated output voltage	DC 5V(±2%)	
	Output current	2.0A	
Power supply status indication		LED On when power supply is normal	
Cable specification		0.75 ~ 2 mm <sup>2</sup>	

\* For protection of the power supply, you are recommended to use the power supply with the maximum of 4A fuse.

#### Notice

(1) Allowable instantaneous interruption time

It is the time to maintain the normal output voltage(normal operation) on the condition that the input voltage(DC24V) is lower than the lowest rated input voltage (DC19.2V).

(2) All field-wiring connections to this unit shall be from Limited Voltage / Limited Current, below 24 Vdc isolated secondary source with an output fused with a 4 A fuse max. or Class 2 secondary circuits as defined in UL 508, 17th Edition

## 3.3.1 Consumption current

Type	Model	Consumption current (Unit : mA)
Main unit	XBM-DN32H	430
Expansion I/O module	XBE-DC32A	50
	XBE-DC16A/B	40
	XBE-DC08A	20
	XBE-RY16A	440
	XBE-RY08A/B	240
	XBE-TN32/16/08A	80/50/40
	XBE-DR16A	250
	XBE-TP32/16/08A	80/50/40
	Expansion Special module	XBF-AD04A
XBF-AD08A		105
XBF-AH04A		120
XBF-DV04A		110
XBF-DC04A		110
XBF-RD04A		100
XBF-RD01A		100
XBF-TC04S		100
XBF-PD02A		500
XBF-HO02A		270
XBF-HD02A		330
XBF-AD04C		105
XBF-DC04C		70
XBF-DV04C		70
XBF-TC04RT		120
XBF-TC04TT		120
XBF-LD02S		110
Expansion Communication module		XBL-C21A
	XBL-C41A	110
	XBL-EMTA	190
	XBL-EIMT/F/H	280/670/480
	XBL-EIPT	400
	XBL-CMEA	150
	XBL-CSEA	150
	XBL-PMEC	300
	XBL-PSEA	230
	XBL-DSEA	100
XBL-RMEA	250	

### 3.3.2 Calculation Example of Consumption Current/Voltage

Calculate the consumption current and configure the system not to exceed the output current capacity of main unit. Refer to 3.3.1 for each module's consumption current

(1) XGB PLC configuration example 1

Consumption of current/voltage is calculated as follows.

Type	Model	Unit No.	Internal 5V consumption current (Unit : mA)	Remark
Main unit	XBM-DN32U	1	430	In case all contact points are On. (Maximum consumption current)
Expansion module	XBE-DC32A	2	50	
	XBE-TN32A	2	80	
	XBF-AD04A	1	120	All channel is used. (Maximum consumption current)
	XBF-DC04A	1	110	
	XBL-C21A	1	110	
Consumption current	1,030mA			-
Consumption voltage	5.15W			1.03A x 5V = 5.15W

In case system is configured as above, since 5V consumption current is total 1,030 mA and 5V output of XGB 32 points main unit is maximum 2A, normal system configuration is available.

(2) XGB PLC configuration example 2

Type	Model	Unit No.	Internal 5V consumption current (Unit : mA)	Remark
Main unit	XBC-DN32H	1	430	In case all contact points are On. (Maximum consumption current)
Expansion module	XBE-DR16A	2	250	
	XBE-RY16A	2	440	
	XBF-AD04A	2	120	All channel is used. (Maximum consumption current)
	XBL-C21A	1	110	
Consumption current	2,040mA			-
Consumption voltage	10.2W			2.04 * 5V = 10.2W

In case system is configured as above, since 5V consumption current is total 2,040 mA and 5V output of XGB 32 points main unit is maximum 2A, configuration is not available. This total consumption current is calculated when all input/output points are on. For safety for system, it is recommended to use higher specification of main unit.



## 3.4 Battery

### 3.4.1 Battery specifications

Items	Specifications										
Nominal voltage / current	DC 3.0V / 6.5 mAh										
Warranty term	3 years(at room temperature)										
Purpose	RTC operation during the blackout										
Charging time	<table border="1"> <caption>Charging Time Data</caption> <thead> <tr> <th>Charging Time (h)</th> <th>Charging Percentage (%)</th> </tr> </thead> <tbody> <tr> <td>4</td> <td>25%</td> </tr> <tr> <td>24</td> <td>65%</td> </tr> <tr> <td>36</td> <td>80%</td> </tr> <tr> <td>72</td> <td>100%</td> </tr> </tbody> </table>	Charging Time (h)	Charging Percentage (%)	4	25%	24	65%	36	80%	72	100%
Charging Time (h)	Charging Percentage (%)										
4	25%										
24	65%										
36	80%										
72	100%										
Backup time	About 6 months(25°C) <table border="1"> <thead> <tr> <th>surrounding temperature</th> <th>Back-up time</th> </tr> </thead> <tbody> <tr> <td>70°C</td> <td>about 195 days</td> </tr> <tr> <td>25°C</td> <td>about 183 days</td> </tr> <tr> <td>-25°C</td> <td>about 133 days</td> </tr> </tbody> </table>	surrounding temperature	Back-up time	70°C	about 195 days	25°C	about 183 days	-25°C	about 133 days		
surrounding temperature	Back-up time										
70°C	about 195 days										
25°C	about 183 days										
-25°C	about 133 days										

### 3.4.2 Instruction for Use

- (1) It is impossible to exchange inner battery
- (2) Do not apply heat or solder electrode (It may cause a battery's life-shortening)
- (3) Do not measure voltage with a tester or short-circuit (It may be the cause of a fire.)
- (4) Do not disassemble the battery.
- (5) Do not change the battery on purpose.

### 3.4.3 Battery Life

Battery's life may be different depending on the conditions of blackout time, service temperature, etc.

Battery can be charged when power is on, and be used for RTC function.

Battery can be discharged when PLC power have been off for a long time. When you put power on PLC, it will be charged automatically. Program and data backup should be preserved with no regard to battery discharge.

### 3.5 Performance specifications

The XBM-DN32H unit's common performance specifications for CPU are as below.

Items		Specifications	Remark
		XBM-DN32H	
Program control method		Cyclic execution of stored program, Time-driven interrupt, Process-driven interrupt	
I/O control method		Batch processing by simultaneous scan (Refresh method), Directed by program instruction	
Program language		Ladder Diagram, Instruction List	
Number of instructions	Basic	28	
	Application	677	
Processing speed (Basic instruction)		83ns/step	
Program capacity		20Kstep	
Max. I/O points		256 points (Main + Expansion 7 stages)	
Data area	P	P00000 ~ P1023F (16,384 point)	Input/Output
	M	M00000 ~ M1023F (16,384 point)	
	K	K00000 ~ K4095F (65,536 point)	
	L	L00000 ~ L4095F (65,536 point)	Link
	F	F00000 ~ F1023F (16,384 point)	
	T	100ms, 10ms, 1ms: T0000 ~ T1023	Timer
	C	C000 ~ C1023	Counter
	S	S00.00 ~ S127.99	Step
	D	D00000 ~ D10239	Data register
	U	U00.00 ~ U08.31	Analog Data
	Z	Z000~Z127 (128 word)	
N	N0000~N10239(10,240 word)		
Total program		128	
Initial task	Initial task	1	
	Cyclic task	Max 16	
	I/O task	Max 8	
	Internal device task	Max 16	
	High Speed Counter task	Max 4	
Operation mode		RUN, STOP, DEBUG	
Self-diagnosis function		Detects errors of scan time, memory, I/O and power supply	
Program port		USB 1 channel	
Back-up method		Latch area setting in basic parameter	
Internal consumption current		430mA	
Weight		134g	

Items	Specifications	Remark
-------	----------------	--------

		XBM-DN32H	
Built-in Function	PID control		Control by instruction, auto-tuning, PWM output, Forced output, Operation scan time setting, Antiwindup, Delta MV, PV tracking, Hybrid operation, Cascade operation
	Cnet	PID control	Dedicated protocol(XGT) Modbus protocol User defined protocol , LS bus(inverter protocol)
		Channel	RS-232C 1 port and RS-485 1 port
	Enet	Transfer spec	Cable: 100Base-TX Speed: 100Mbps Auto-MDIX*1 IEEE 802.3
		Topology	Line, Star
		Diagnosis	Module information, Service condition
		Protocol	XGT dedicated, Modbus TCP/IP, user define frame
		Service	P2P, High Speed link, Remote connection,SMTP,SNTP, Auto scan
	High Speed Counter	Performance	1 phase: 100kHz(2 phase: 50kHz)
		channels	1phase 4 channels, 2 phase 2 channels
		Counter mode	4 counter modes are supported based on input pulse and INC/DEC method <ul style="list-style-type: none"> <li>• 1 pulse operation Mode : INC/DEC count by program</li> <li>• 1 pulse operation Mode : INC/DEC count by phase B pulse input</li> <li>• 2 pulse operation Mode : INC/DEC count by input pulse</li> <li>• 2 pulse operation Mode : INC/DEC count by difference of phase</li> </ul>
		Function	<ul style="list-style-type: none"> <li>• Internal/external preset</li> <li>• Latch counter</li> <li>• Compare output</li> <li>• No. of rotation per unit time</li> </ul>
	Position	Basic function	No. of control axis: 2axis Pulse output type : pulse+ direction Position data: 80 steps for each axis(1~80) Operation mode: end, keep, continuous Operation method: single, repeat
		Position	Absolute method / Incremental method Position address range: -2,147,483,648 ~ 2,147,483,647(Pulse) Speed range: 1 ~ 100,000pps(1pps unit) Acc/dec processing: Trapezoid-shaped
		Origin return method	Detect origin after DOG turns Off When DOG is On, detect the origin after deceleration Detect the origin by DOG
		Jog operation	1~100,000pps(high/low)
		Pulse catch	10μs 4point(P0000 ~ P0003), 50μs 4point(P0004 ~ P0007)
	External point Interrupt	10μs 4point(P0000 ~ P0003), 50μs 4point(P0004 ~ P0007)	
	Input filter	1,3,5,10,20,70,100ms	

\*1 Auto-MDIX(Automatic medium-dependent interface crossover) : It is the function to automatically detect whether the cable connected to the Ethernet port is peer-to-peer(straight) or cross cable

## Chapter 4 Installation and wiring

### 4.1 Parameter & Operation data



#### Danger

- ▶ Please design protection circuit at the external of PLC for entire system to operate safely because an abnormal output or an malfunction may cause accident when any error of external power or malfunction of PLC module.
  - (1) It should be installed at the external side of PLC to emergency stop circuit, protection circuit, interlock circuit of opposition action such as forward /reverse operation and interlock circuit for protecting machine damage such as upper/lower limit of positioning.
  - (2) If PLC detects the following error, all operation stops and all output is off.
    - (Available to hold output according to parameter setting)
    - (a) When over current protection equipment or over voltage protection operates
    - (b) When self diagnosis function error such as WDT error in PLC CPU occurs
- ▶ When error about IO control part that is not detected by PLC CPU, all output is off.

Design Fail Safe circuit at the external of PLC for machine to operate safely. Refer to 4.1.1 Fail Safe circuit.

  - (1) Because of error of output device, Relay, TR, etc., output may not be normal. About output signal that may cause the heavy accident, design supervisory circuit to external.
- ▶ When load current is more than rating or over current by load short flows continuously, danger of heat, fire may occur so design safety circuit to external such as fuse.
- ▶ Design for external power supply to be done first after PLC power supply is done. If external power supply is done first, it may cause accident by misoutput, misoperation.
- ▶ In case communication error occurs, for operation status of each station, refer to each communication manual.
- ▶ In case of controlling the PLC while peripheral is connected to CPU module, configure the interlock circuit for system to operate safely. During operation, in case of executing program change, operation status change, familiarize the manual and check the safety status. Especially, in case of controlling long distance PLC, user may not response to error of PLC promptly because of communication error or etc.

Limit how to take action in case of data communication error between PLC CPU and external device adding installing interlock circuit at the PLC program.

 **Danger**

- ▶ Don't close the control line or communication cable to main circuit or power line. Distance should be more than 100mm.  
It may cause malfunction by noise.
- ▶ In case of controlling lamp load, heater, solenoid valve, etc. in case of Off -> On, large current (10 times of normal current) may flows, so consider changing the module to module that has margin at rated current.
- ▶ Process output may not work properly according to difference of delay of PLC main power and external power for process (especially DC in case of PLC power On-Off and of start time.  
For example, in case of turning on PLC main power after supplying external power for process, DC output module may malfunction when PLC is on, so configure the circuit to turn on the PLC main power first  
Or in case of external power error or PLC error, it may cause the malfunction.
- ▶ Not to lead above error to entire system, part causing breakdown of machine or accident should be configured at the external of PLC

# Chapter 4 Installation and wiring

## 4.1.1 fail safe circuit

(1) example of system design (When ERR contact point of power module is not used)

In case of AC

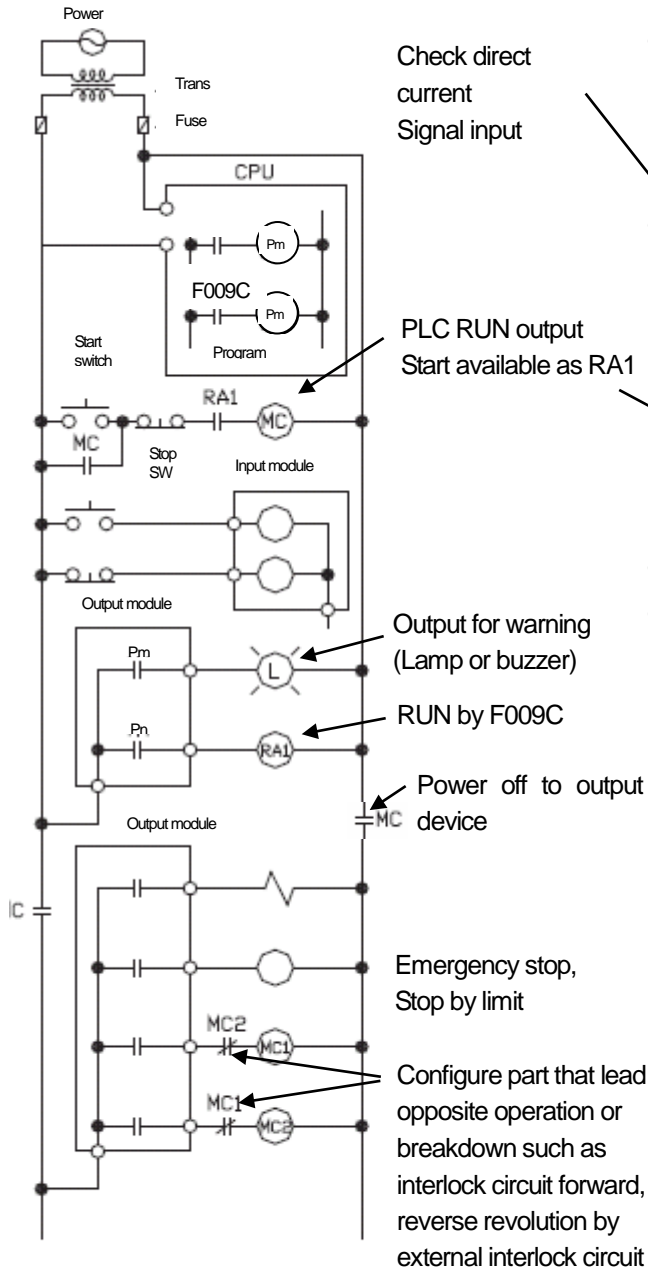

In case of AC . DC

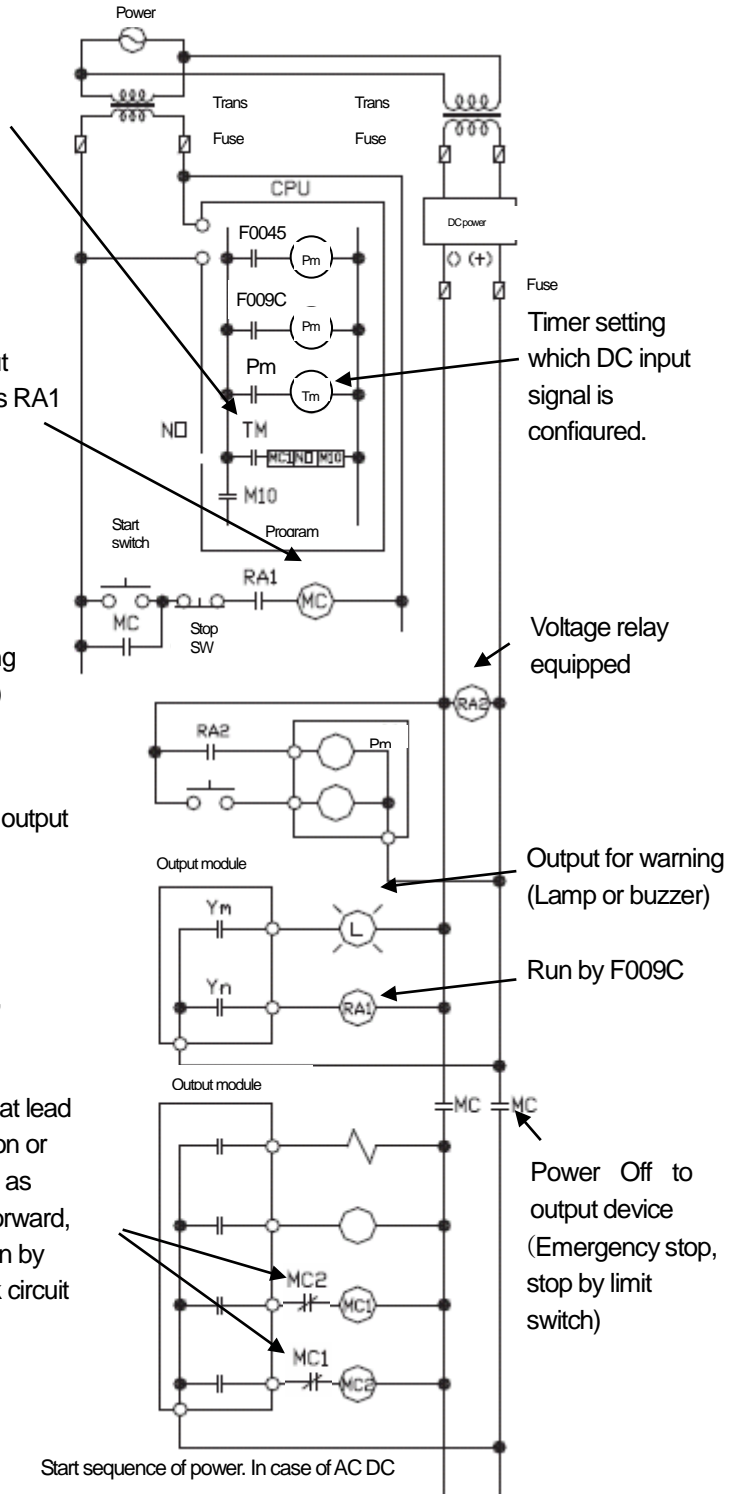

Start sequence of power. In case of AC

- (1) Turn on power
- (2) Run CPU.
- (3) Turn on start switch
- (4) Output device runs by program through magnetic contactor (MC) [On]

Start sequence of power. In case of AC DC

- (1) Run CPU after power is on
- (2) Turn on RA2 as DC power on
- (3) Turn on timer after DC power is stable.
- (4) Turn on start switch
- (5) Output device runs by program through magnetic contactor (MC) [On]

(2) Fail Safe Measures in case of PLC failures

Failures of the PLC CPU and memory are detected by self-diagnosis but if there are some problems with I/O control part, etc, the failure may not be detected from the CPU. In this case, it can be different depending on the failure status, all contacts may be On or Off so normal operation or safety of the controlled subject cannot be guaranteed.

We have done our best to assure quality but in case there are some problems with the PLC, please configure the fail safe circuit on the outside to prevent damage of the equipment or accident due to some cause. The below is the example of system configuration with the fail sage circuit.

<System example>

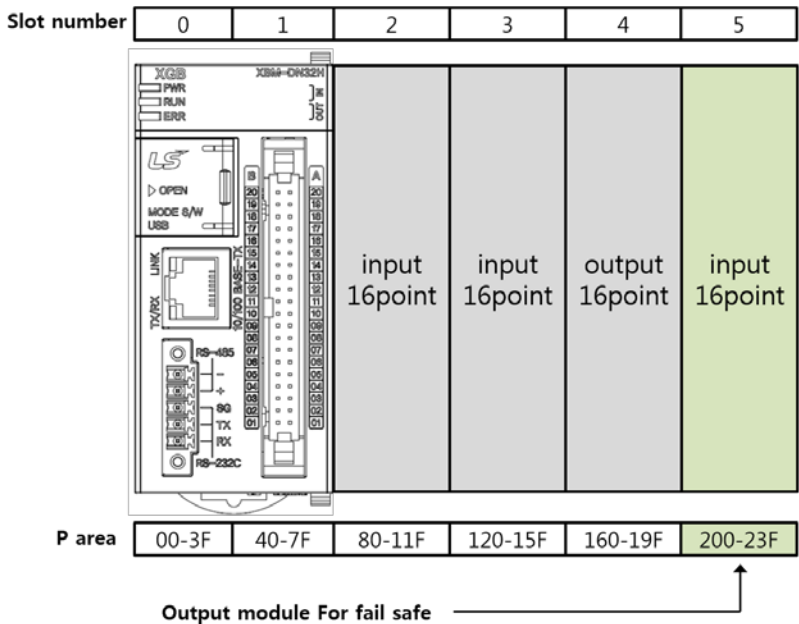

\* Equip output module for fail safe to last slot of system.  
[Fail safe circuit example]

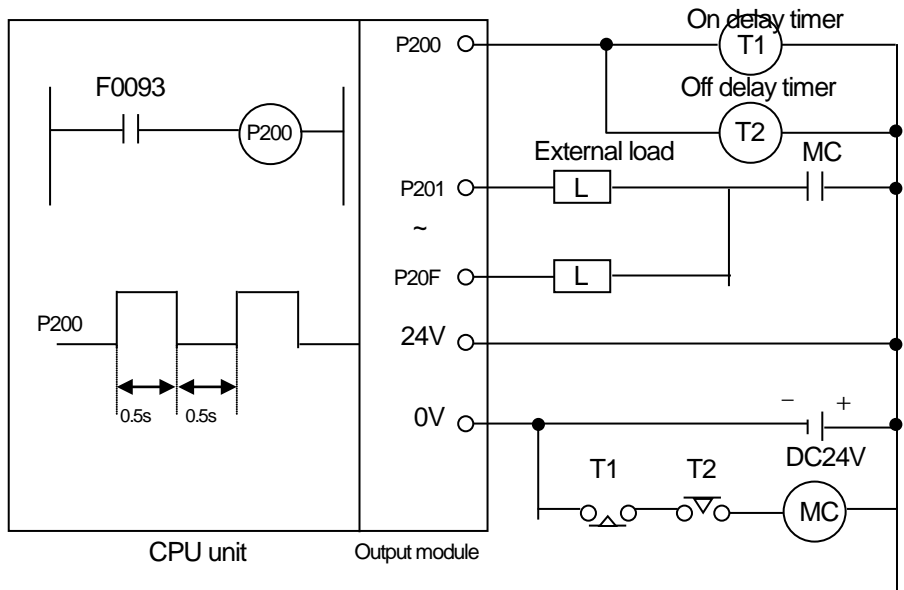

Since P200 turn on/off every 0.5s, use TR output.

## 4.1.2 PLC heat calculation

## (1) Power consumption of each part

## (a) Power consumption of module

The power conversion efficiency of power module is about 70% and the other 30% is gone with heat; 3/7 of the output power is the pure power consumption. Therefore, the calculation is as follows.

- $W_{pw} = 3/7 \{ (I_{5V} \times 5) + (I_{24V} \times 24) \}$  (W)

$I_{5V}$ : power consumption of each module DC5V circuit (internal current consumption)

$I_{24V}$ : the average current consumption of DC24V used for output module  
(current consumption of simultaneous On point)

If DC24V is externally supplied or a power module without DC24V is used, it is not applicable.

## (b) Sum of DC5V circuit current consumption

The DC5V output circuit power of the power module is the sum of power consumption used by each module.

- $W_{5V} = I_{5V} \times 5$  (W)

## (c) DC24V average power consumption (power consumption of simultaneous On point)

The DC24V output circuit's average power of the power module is the sum of power consumption used by each module.

- $W_{24V} = I_{24V} \times 24$  (W)

## (d) Average power consumption by output voltage drop of the output module (power consumption of simultaneous On point)

- $W_{out} = I_{out} \times V_{drop} \times \text{output point} \times \text{simultaneous On rate}$  (W)

$I_{out}$ : output current (actually used current) (A)

$V_{drop}$ : voltage drop of each output module (V)

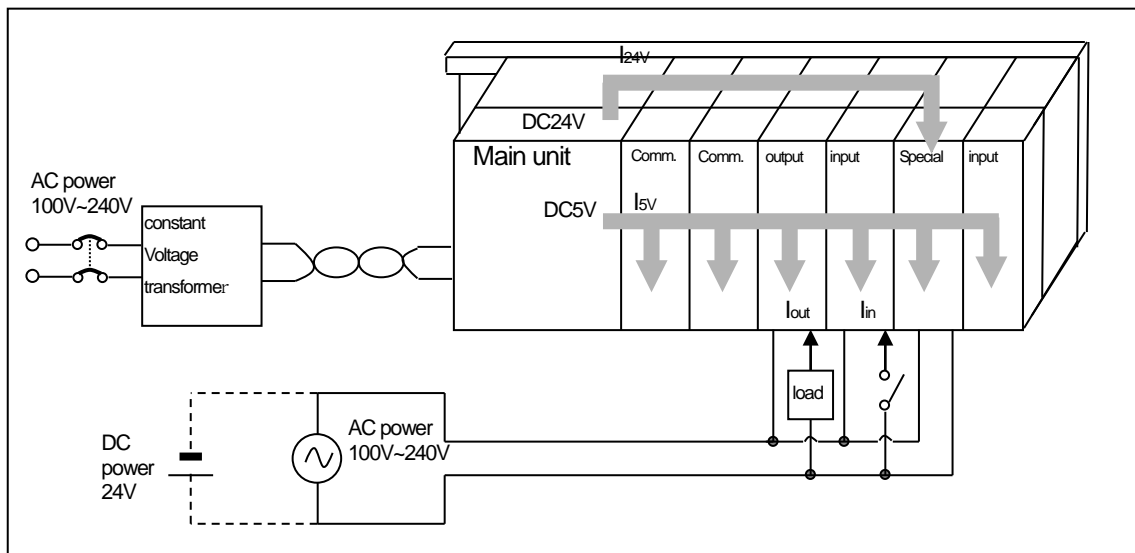



(e) Input average power consumption of input module

(power consumption of simultaneous On point)

- $W_{in} = I_{in} \times E \times$  input point  $\times$  simultaneous On rate (W)

$I_{in}$ : input current (root mean square value in case of AC) (A)

$E$  : input voltage (actually used voltage) (V)

(f) Power consumption of special module power assembly

- $W_s = I_{5V} \times 5 + I_{24V} \times 24 + I_{100V} \times 100$  (W)

The sum of power consumption calculated by each block is the power consumption of the entire PLC system.

- $W = W_{PW} + W_{5V} + W_{24V} + W_{out} + W_{in} + W_s$  (W)

Calculate the heats according to the entire power consumption(W) and review the temperature increase within the control panel.

The calculation of temperature rise within the control panel is displayed as follows.

$$T = W / UA \text{ [}^\circ\text{C]}$$

$W$  : power consumption of the entire PLC system (the above calculated value)

$A$  : surface area of control panel [ $\text{m}^2$ ]

$U$  : if equalizing the temperature of the control panel by using a fan and others : 6

If the air inside the panel is not ventilated : 4

If installing the PLC in an air-tight control panel, it needs heat-protective(control) design considering the heat from the PLC as well as other devices. If ventilating by vent or fan, inflow of dust or gas may affect the performance of the PLC system.

## 4.2 Attachment/Detachment of Modules

Here describes about basic parameter of embedded positioning.

### 4.2.1 Attachment/Detachment of modules

Caution in handling

Use PLC in the range of general specification specified by manual.

In case of usage out of range, it may cause electric shock, fire, malfunction, damage of product.



### Remark

- ▶ Module must be mounted to hook for fixation properly before its fixation.  
The module may be damaged from over-applied force. If module is not mounted properly, it may cause malfunction.
- ▶ Do not drop or impact the module case, terminal block connector.
- ▶ Do not separate PCB from case.

#### (1) Equipment of module

- Eliminate the Extension Cover at the product.
- Push the product and connect it in agreement with Hook For Fixation of four edges and Hook For Connection at the bottom.
- After connection, push down the Hook For Fixation and fix it completely.

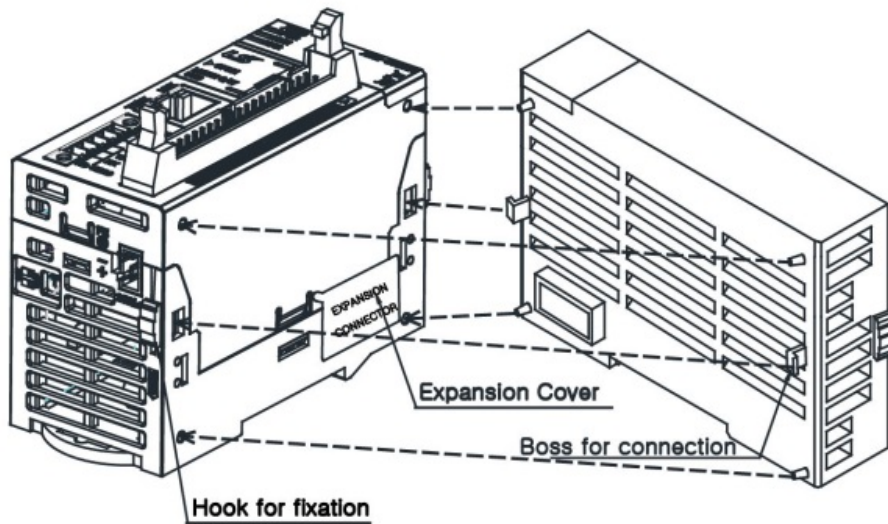

#### (2) Detachment of module

- Push up the Hook For Disconnection, and then detach the product with two hands.  
(Do not detach the product by force)



### Remark

- ▶ When separating module, do not apply excessive force. If so, hook may be damaged.

### (3) Installation of module

XGB PLC has a hook for DIN rail (rail width: 35mm) so that can be installed at DIN rail.

#### (a) In case of installing at DIN rail

- Pull the hook as shown below for DIN rail at the bottom of module and install it at DIN rail
- Push the hook to fix the module at DIN rail after installing module at DIN rail

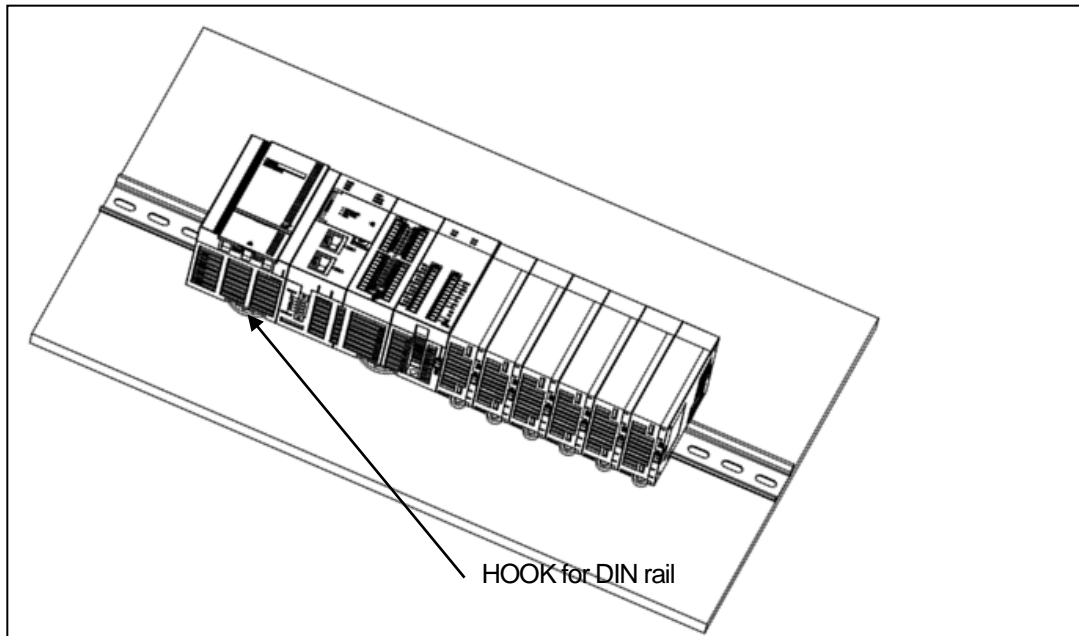

#### (b) In case of installing at panel

- You can install XGB compact type main unit onto a panel directly using screw hole
- Use M4 type screw to install the product onto a panel.

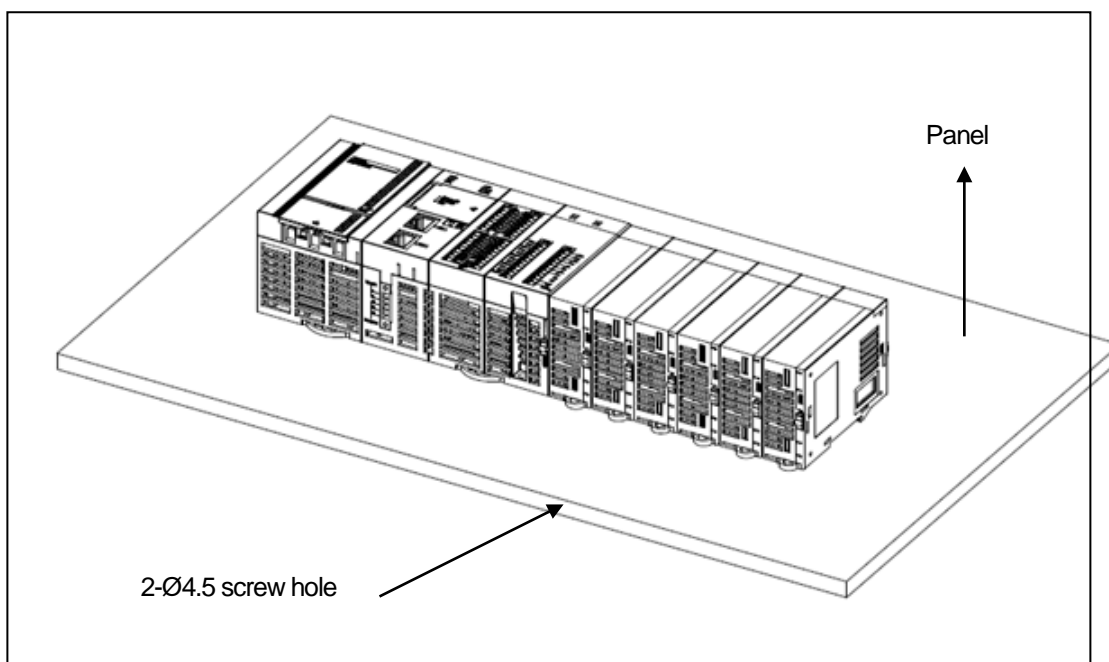

## (4) Module equipment location

Keep the following distance between module and structure or part for ventilation, easy detachment and attachment.

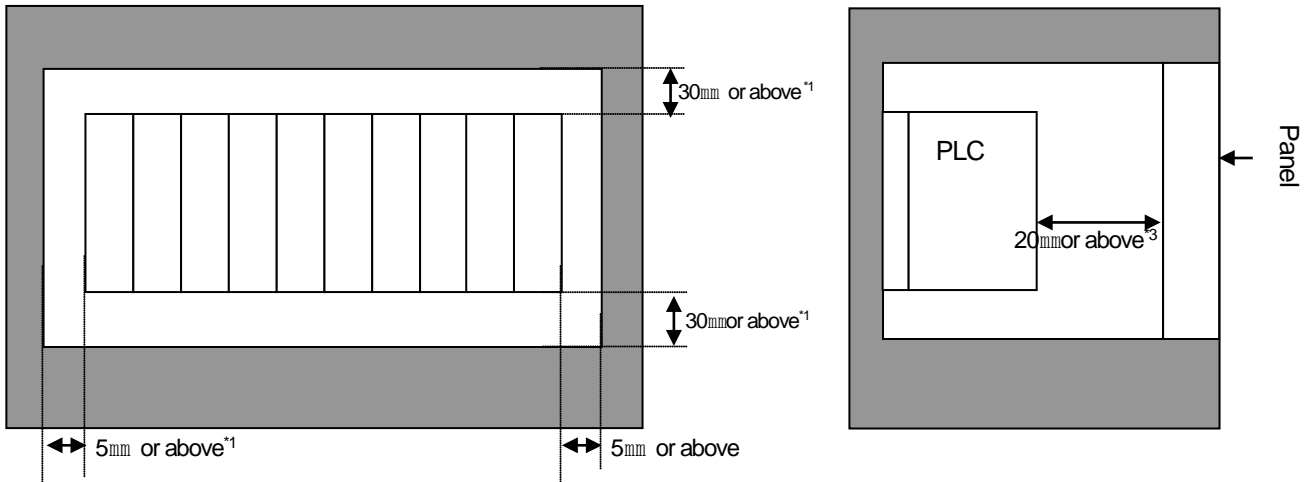

\*1 : In case height of wiring duct is less than 50 mm (except this 40mm or more)

\*2 : In case of equipping cable without removing near module, 20mm or more

\*3 : In case of connector type, 20mm or above

## (5) Module equipment direction

(a) For easy ventilation, install as shown below.

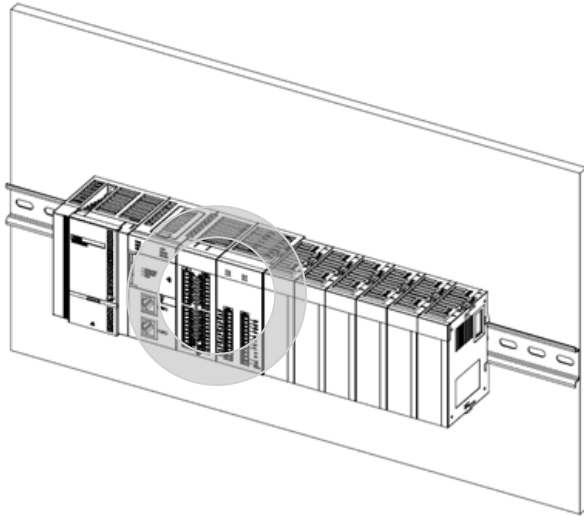

(b) Don't install as shown below.

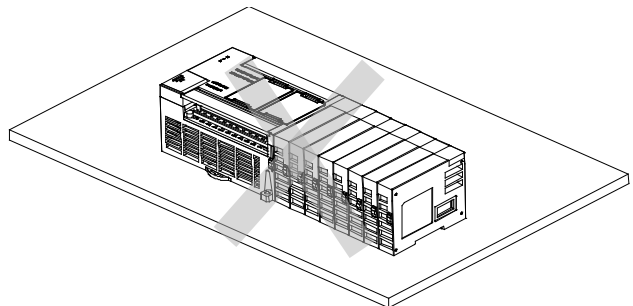
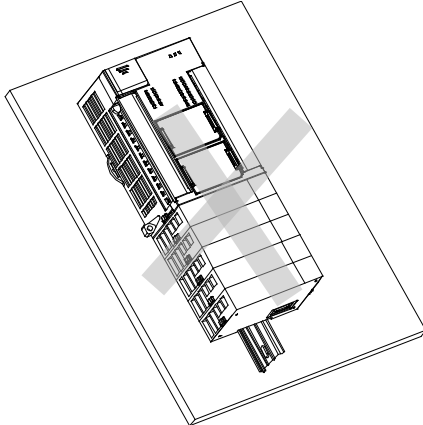

#### (6) Distance with other device

To avoid radiation noise or heat, keep the distance between PLC and device (connector and relay) as far as the following figure.

Device installed in front of PLC: 100 mm or more

Device installed beside PLC: 50 mm or more

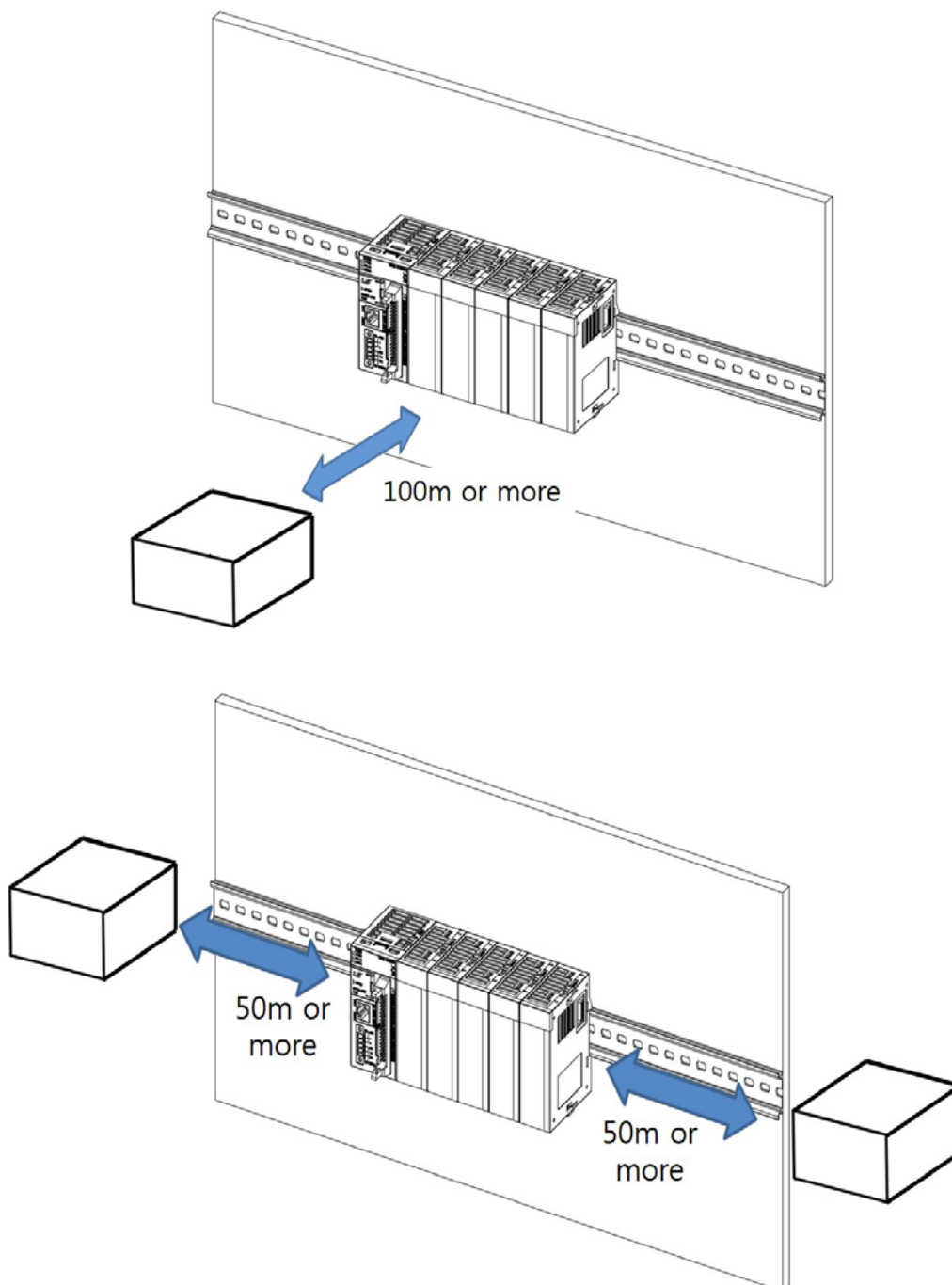

#### 4.2.2 Caution in handling

Here describes caution from open to install

- Don't drop or impact product.
- Don't disassemble the PCB from case. It may cause an error.
- In case of wiring, make sure foreign substance not to enter upper part of module. If it enters, eliminate it.

## (1) Caution in handling IO module

It describes caution in handling IO module.

## (a) Recheck of IO module specification

For input module, be cautious about input voltage, for output module, if voltage that exceeds the max. open/close voltage is induced, it may cause the malfunction, breakdown or fire.

## (b) Used wire

When selecting wire, consider ambient temp, allowed current and minimum size of wire is AWG22(0.3mm<sup>2</sup>) or above.

## (c) Environment

In case of wiring IO module, if device or material that induce high heat is too close or oil contacts wire too long time, it may cause short, malfunction or error.

## (d) Polarity

Before supplying power of module which has terminal block, check the polarity.

## (e) Wiring

- In case of wiring IO with high voltage line or power line, induced obstacle may cause error.
- Let no cable pass the IO operation indication part (LED).  
(You can't discriminate the IO indication.)
- In case induced load is connected with output module, connect the surge killer or diode load in parallel. Connect cathode of diode to + side of power.

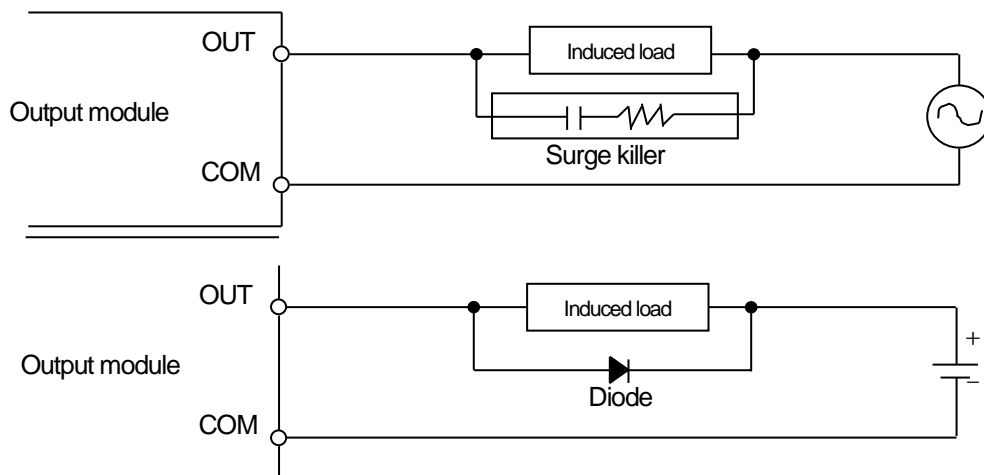

## (f) Terminal block

Check close adhesion status. Let no foreign material enter into PLC when wiring terminal block or processing screw hole as it may cause malfunction, it may cause malfunction.

## (g) Don't impact IO module or don't disassemble the PCB from case.

### 4.3 Wire

In case using system, it describes caution about wiring.



#### Danger

- ▶ When wiring, cut off the external power.
- ▶ If all power is cut, it may cause electric shock or damage of product.
- ▶ In case of flowing electric or testing after wiring, equip terminal cover included in product. If not, it may cause electric shock.



#### Remark

- ▶ Do D type ground (type 3 ground) or above dedicated for PLC for FG and LG terminal. It may cause electric shock or malfunction.
  - ▶ When wiring module, check the rated voltage and terminal array and do properly.
- If rating is different, it may cause fire, malfunction.
- ▶ For external connecting connector, use designated device and solder.
- If connecting is not safe, it may cause short, fire, malfunction.
- ▶ For screwing, use designated torque range. If it is not fit, it may cause short, fire, malfunction.
  - ▶ Let no foreign material enter such as garbage or disconnection part into module. It may cause fire, malfunction, error.

#### 4.3.1 Power wiring

(1) AC110V/AC220V/DC24V cables should be compactly twisted and connected in the shortest distance

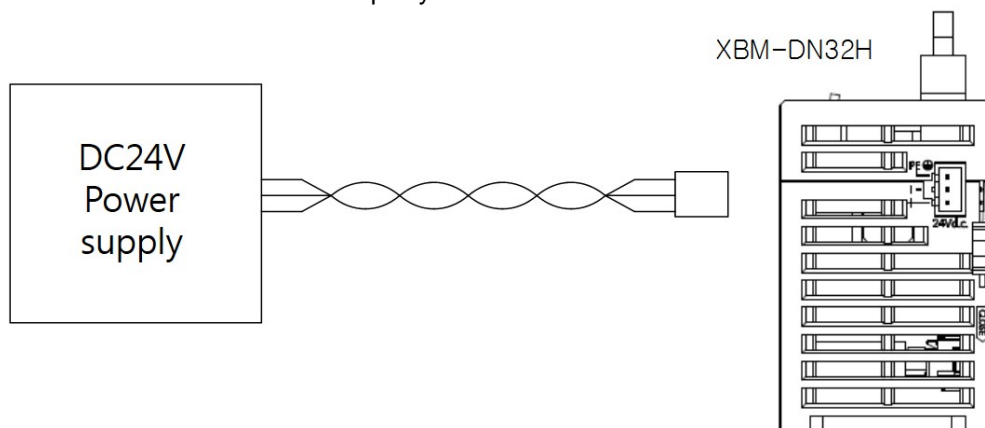

(2) DC Power supply capacity should be 1A or more

(3) Isolate the PLC power, I/O devices and power devices as follows.

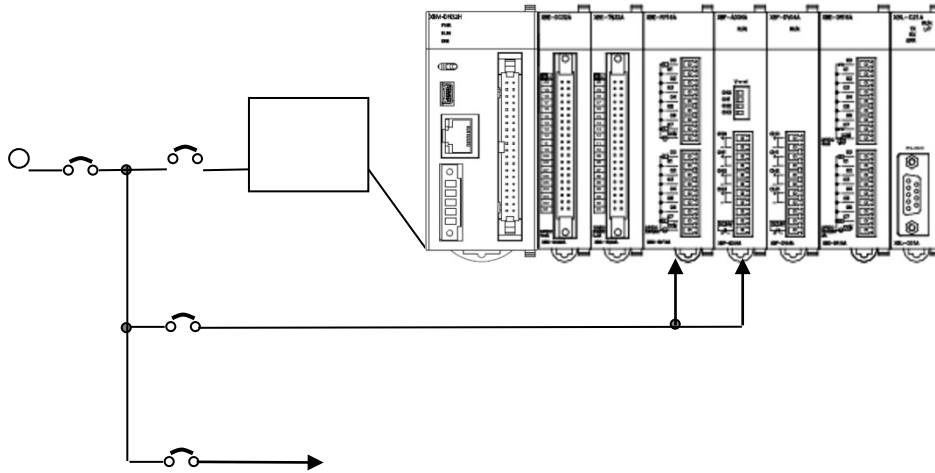

(4) AC110V/AC220V cable should be as thick as possible(2mm<sup>2</sup>) to reduce voltage drop

(5) AC110V/ DC24V cables should not be installed close to main circuit cable(high voltage/high current) and I/O signal cable. They should be 100mm away from such cables

(6) When noise may be intruded inside it, use an insulated shielding transformer or noise filter.

(7) To prevent surge from lightning, use the lightning surge absorber as presented below.

(8) Wiring of each input power should be twisted as short as possible and the wiring of shielding transformer or noise filter should not be arranged via a duct.

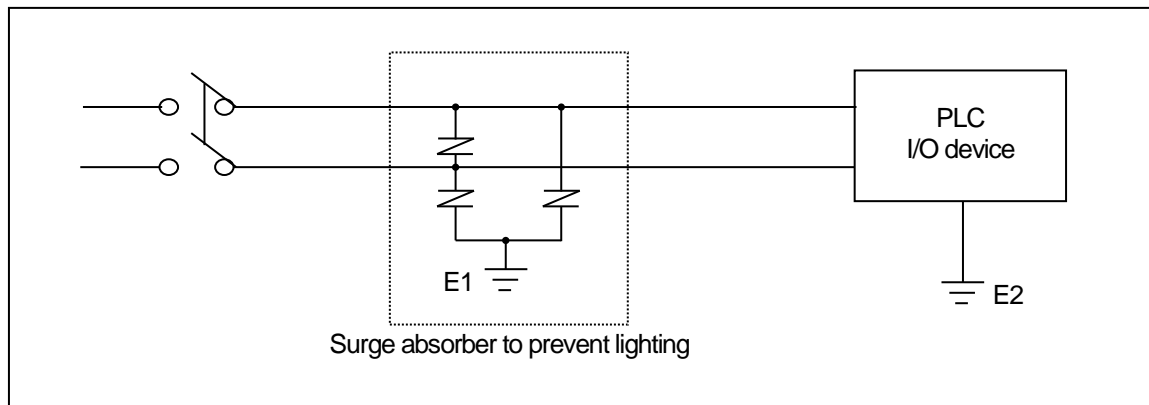

#### Remark

- (1) Isolate the grounding(E1) of lightning surge absorber from the grounding(E2) of the PLC.
- (2) Select a lightning surge absorber type so that the max. voltage may not the specified allowable voltage of the absorber.



### 4.3.2 I/O Device wiring

- (1) The size of I/O device cable is limited to 0.3~2 mm<sup>2</sup> but it is recommended to select a size(0.3 mm<sup>2</sup>) to use conveniently.
- (2) Please isolate input signal line from output signal line.
- (3) I/O signal lines should be wired 100mm and more away from high voltage/high current main circuit cable.
- (4) Batch shield cable should be used and the PLC side should be grounded unless the main circuit cable and power cable can not be isolated.

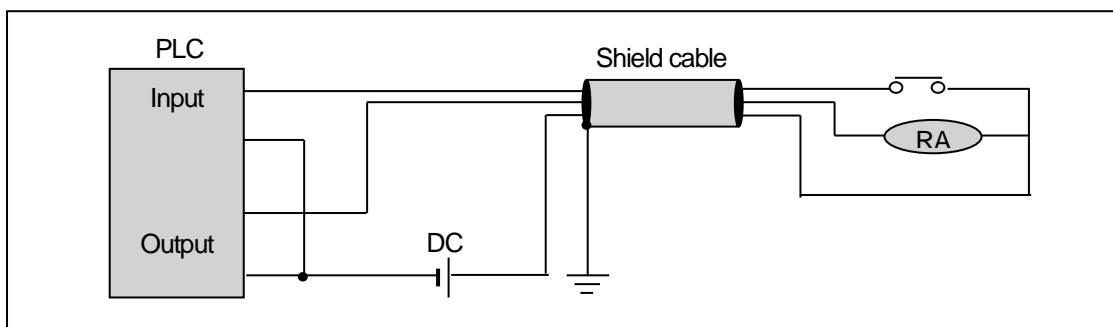

- (5) When applying pipe-wiring, make sure to firmly ground the piping.

(6) Example of input module.

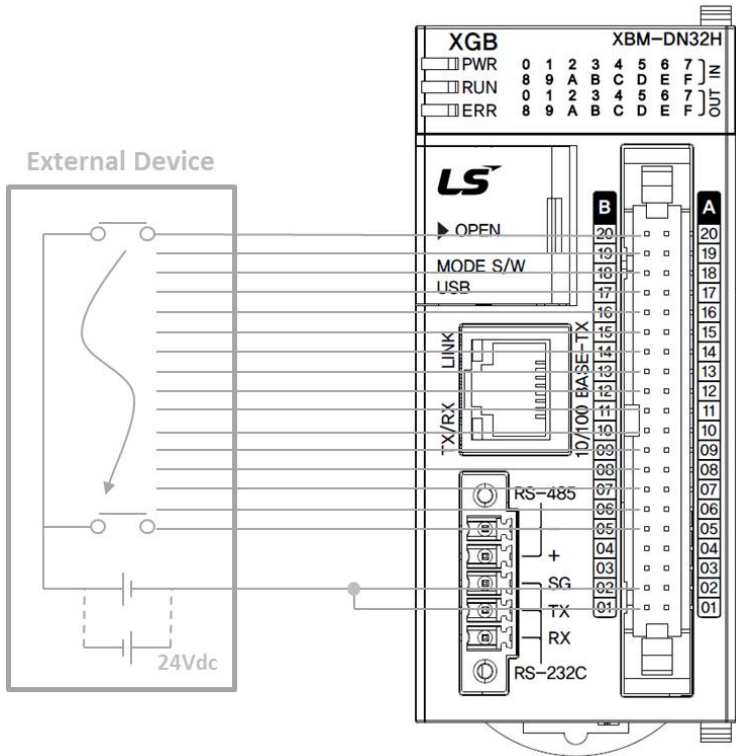

(7) Example of output module.

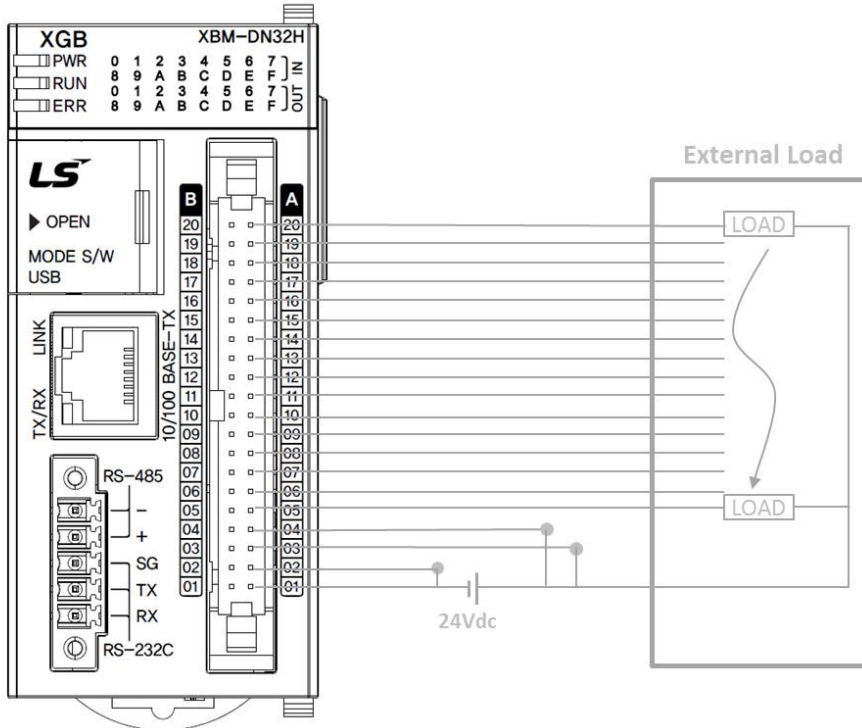

### 4.3.3 Grounding wiring

- (1) The PLC contains a proper noise measure, so it can be used without any separate grounding if there is a large noise. However, if grounding is required, please refer to the followings.
- (2) For grounding, please make sure to use the exclusive grounding.  
For grounding construction, apply type 3 grounding (grounding resistance lower than  $100\ \Omega$ )
- (3) If the exclusive grounding is not possible, use the common grounding as presented in B) of the figure below.

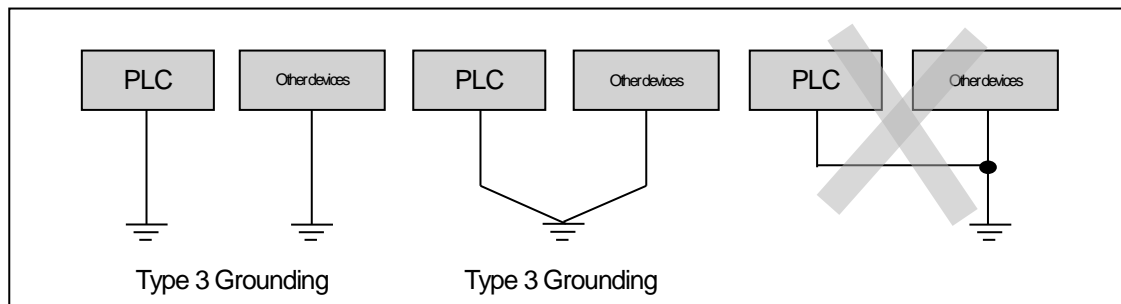

A) Exclusive grounding : best    B) common grounding : good    C) common grounding: defective

- (4) Use the grounding cable more than  $2\ \text{mm}^2$ . To shorten the length of the grounding cable, place the grounding point as close to the PLC as possible.
- (5) If any malfunction from grounding is detected, separate the FG of the base from the grounding.

### 4.3.4 Specifications of wiring cable

The specifications of cable used for wiring are as follows.

Types of external connection	Cable specification ( $\text{mm}^2$ )	
	Lower limit	Upper limit
Digital input	0.18 (AWG24)	1.5 (AWG16)
Digital output	0.18 (AWG24)	2.0 (AWG14)
Analogue I/O	0.18 (AWG24)	1.5 (AWG16)
Communication	0.18 (AWG24)	1.5 (AWG16)
Main power	1.5 (AWG16)	2.5 (AWG12)
Protective grounding	1.5 (AWG16)	2.5 (AWG12)

## Chapter 5 Maintenance

Be sure to perform daily and periodic maintenance and inspection in order to maintain the PLC in the best conditions.

### 5.1 Maintenance and Inspection

The I/O module mainly consist of semiconductor devices and its service life is semi-permanent. However, periodic inspection is requested for ambient environment may cause damage to the devices. When inspecting one or two times per six months, check the following items.

Check Items		Judgment	Corrective Actions
Change rate of input voltage		Within change rate of input voltage	Hold it with the allowable range.
Power supply for input/output		Input/Output specification of each module	Hold it with the allowable range of each module.
Ambient environment	Temperature	0 ~ +55 °C	Adjust the operating temperature and humidity with the defined range.
	Humidity	5 ~ 95%RH	
	Vibration	No vibration	Use vibration resisting rubber or the vibration prevention method.
Play of modules		No play allowed	Securely engage the hook.
Connecting conditions of terminal screws		No loose allowed	Retighten terminal screws.
Spare parts		Check the number of Spare parts and their Store conditions	Cover the shortage and improve the conditions.

### 5.2 Daily Inspection

The following table shows the inspection and items which are to be checked daily.

Check Items		Check Points	Judgment	Corrective Actions
Connection conditions of base		Check the screws.	Screws should not be loose.	Retighten Screws.
Connection conditions of Input/Output module		Check the connecting screws Check module cover.	Screws should not be loose.	Retighten Screws.
Connecting conditions of terminal block or extension cable		Check for loose mounting screws.	Screws should not be loose.	Retighten Screws.
		Check the distance between solderless terminals.	Proper clearance should be provided.	Correct.
		Connecting of expansion cable.	Connector should not be loose.	Correct.
LED indicator	PWR LED	Check that the LED is On.	On (Off indicates an error)	
	Run LED	Check that the LED is On during Run.	On (flickering or On indicates an error)	
	ERR LED	Check that the LED is Off during Run.	Flickering indicates an error	
	Input LED	Check that the LED turns On and Off.	On when input is On, Off when input is off.	
	Output LED	Check that the LED turns On and Off	On when output is On, Off when output is off	

### 5.3 Periodic Inspection

Check the following items once or twice every six months, and perform corrective actions as needed.

Check Items		Checking Methods	Judgment	Corrective Actions
Ambient environment	Ambient temperature	-. Measure with thermometer and hygrometer -. measure corrosive gas	0 ~ 55 °C	Adjust to general standard (Internal environmental standard of control section)
	Ambient Humidity		5 ~ 95%RH	
	Ambient pollution level		There should be no corrosive gases	
PLC Conditions	Looseness, Ingress	The module should be move the unit	The module should be mounted securely.	Retighten screws
	dust or foreign material	Visual check	No dust or foreign material	
Connecting conditions	Loose terminal screws	Re-tighten screws	Screws should not be loose	Retighten
	Distance between terminals	Visual check	Proper clearance	Correct
	Loose connectors	Visual check	Connectors should not be loose.	Retighten connector mounting screws
Line voltage check		Measure voltage between input terminals	3.3 Power specifications	Change supply power

## Chapter 6 Troubleshooting

The following explains contents, diagnosis and corrective actions for various errors that can occur during system operation.

### 6.1 Basic Procedure of Troubleshooting

System reliability not only depends on reliable equipment but also on short downtimes in the event of fault. The short discovery and corrective action are needed for speedy operation of system. The following shows the basic instructions for troubleshooting.

#### (1) Visual checks

Check the following points.

- Machine operating condition (in stop and operation status)
- Power On/Off
- Status of I/O devices
- Condition of wiring (I/O wires, extension and communications cables)
- Display states of various indicators (such as POWER LED, RUN LED, ERR LED and I/O LED)

After checking them, connect peripheral devices and check the operation status of the PLC and the program contents.

#### (2) Trouble Check

Observe any change in the error conditions during the following.

- Switch to the STOP position, and then turn the power on and off.

#### (3) Narrow down the possible causes of the trouble where the fault lies, i.e.:

- Inside or outside of the PLC ?
- I/O module or another module?
- PLC program?

### 6.2 Troubleshooting

This section explains the procedure for determining the cause of troubles as well as the errors and corrective actions.

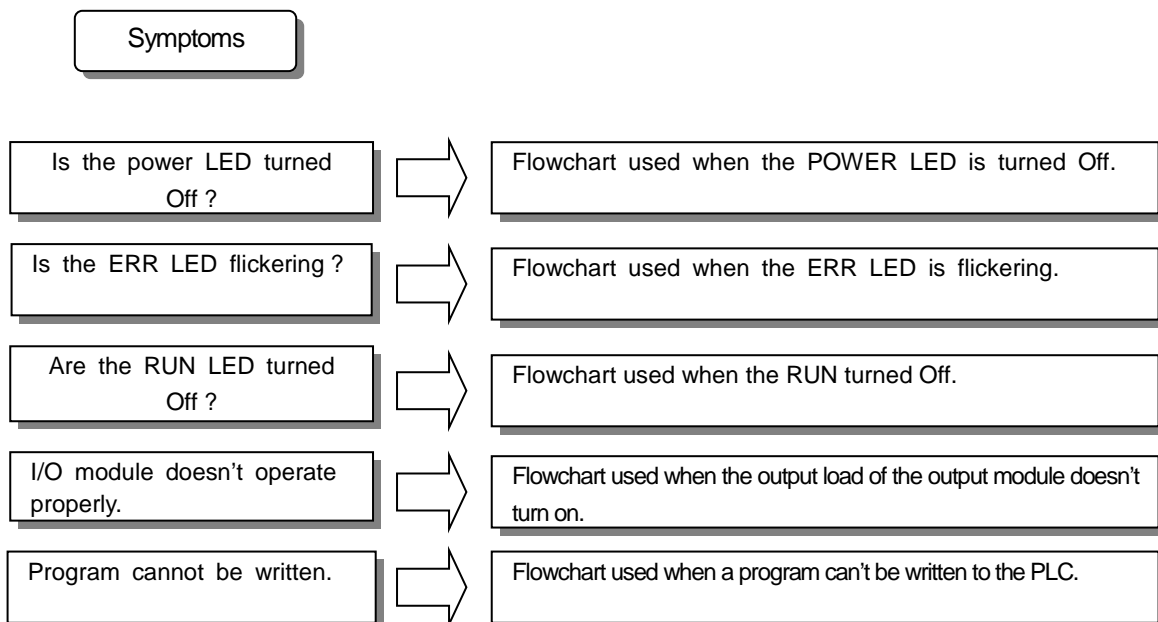

### 6.2.1 Troubleshooting flowchart used when the PWR (Power) LED turns Off

The following flowchart explains corrective action procedure used when the power is supplied or the power LED turns Off during operation.

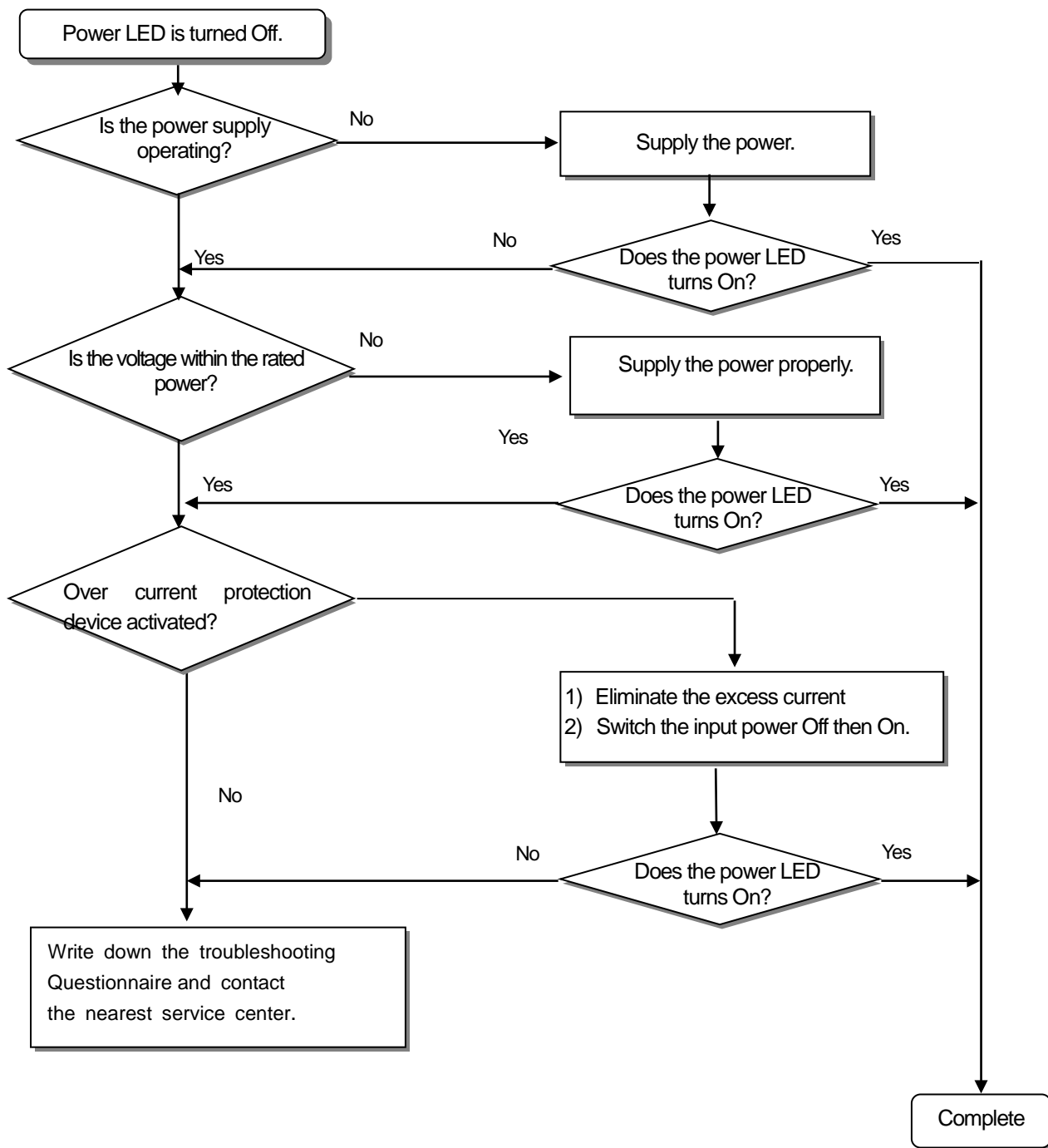

### 6.2.2 Troubleshooting flowchart used with when the ERR (Error) LED is flickering

The following flowchart explains corrective action procedure used when the power is supplied starts or the ERR LED is flickering during operation.

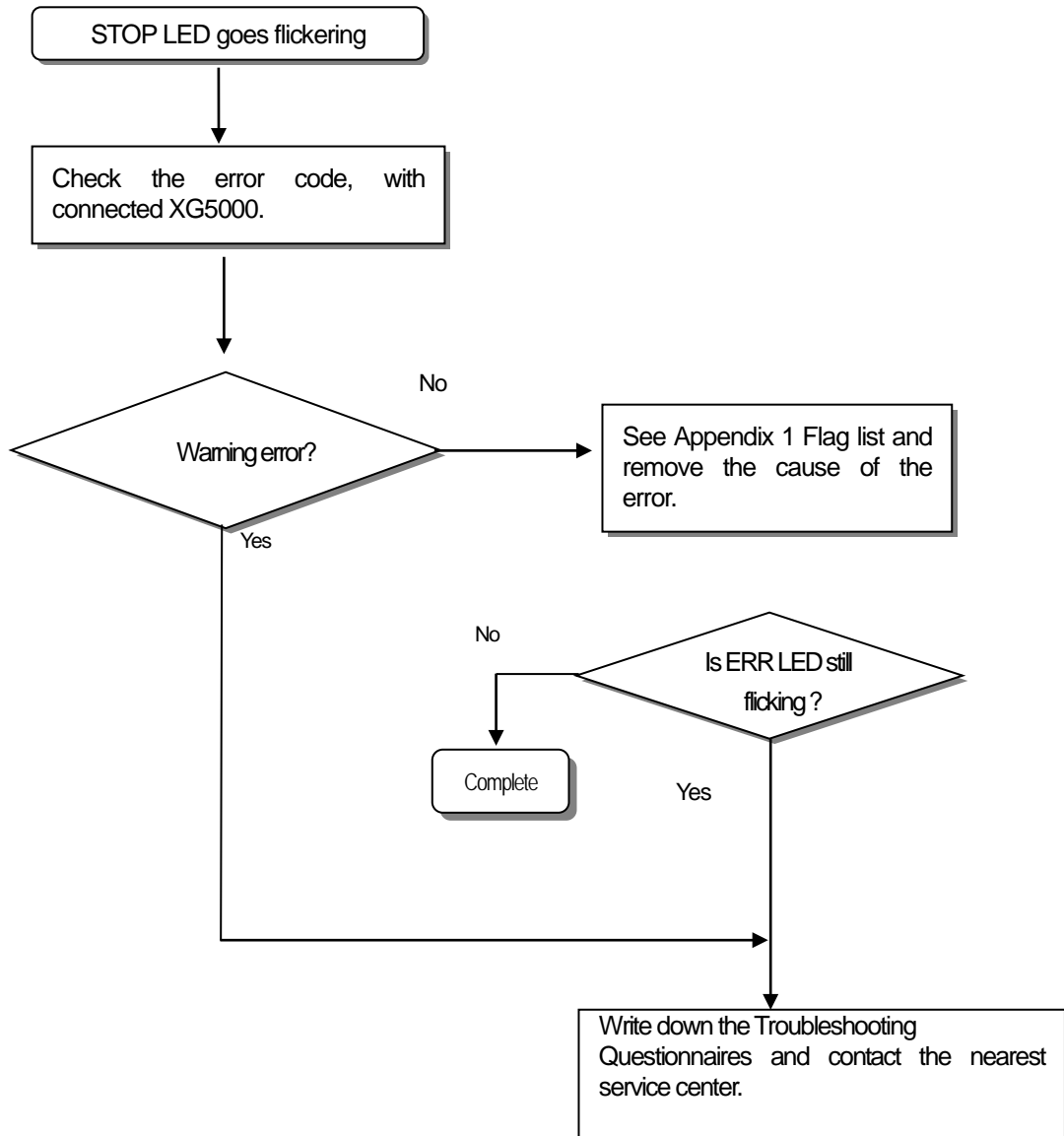

### Warning

Though warning error appears, PLC system doesn't stop but corrective action is needed promptly. If not, it may cause the system failure.



6.2.3 Troubleshooting flowchart used with when the RUN , STOP LED turns Off.

The following flowchart explains corrective action procedure to treat the lights-out of RUN LED when the power is supplied, operation starts or is in the process.

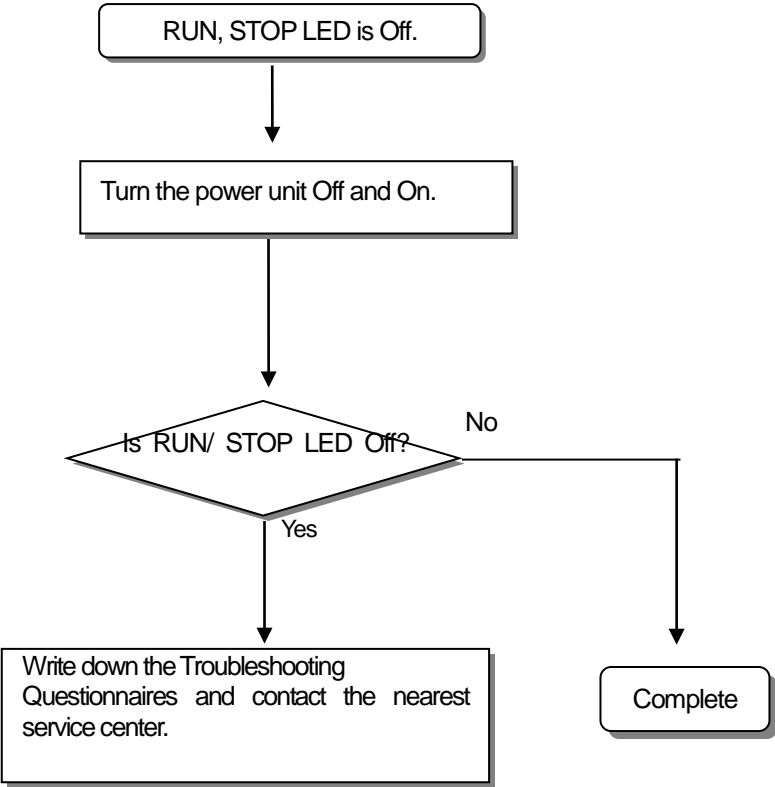

### 6.2.4 Troubleshooting flowchart used when the I/O part doesn't operate normally.

The following flowchart explains corrective action procedure used when the I/O module doesn't operate normally.

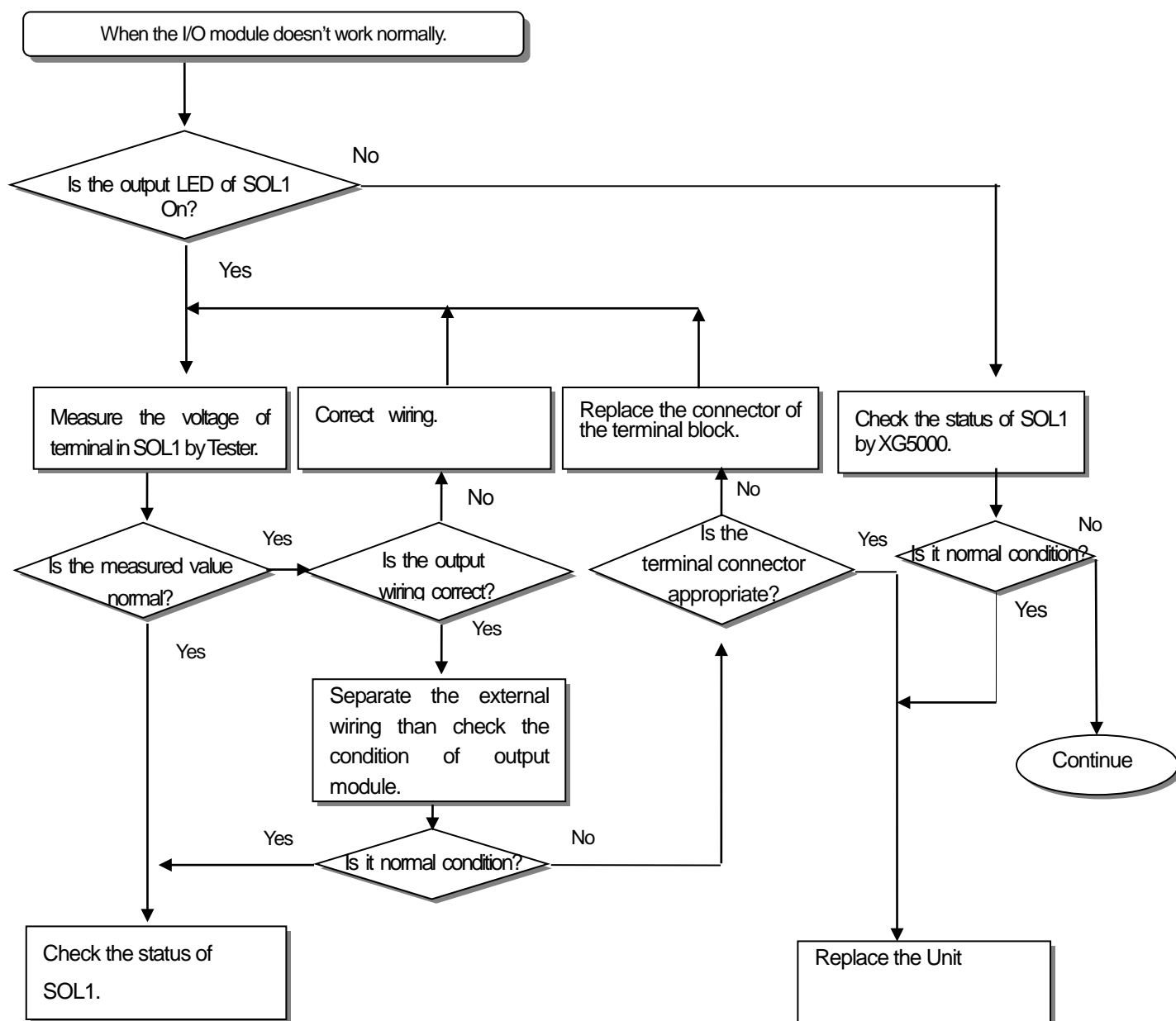
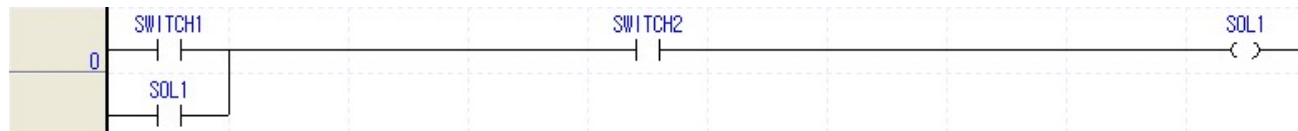

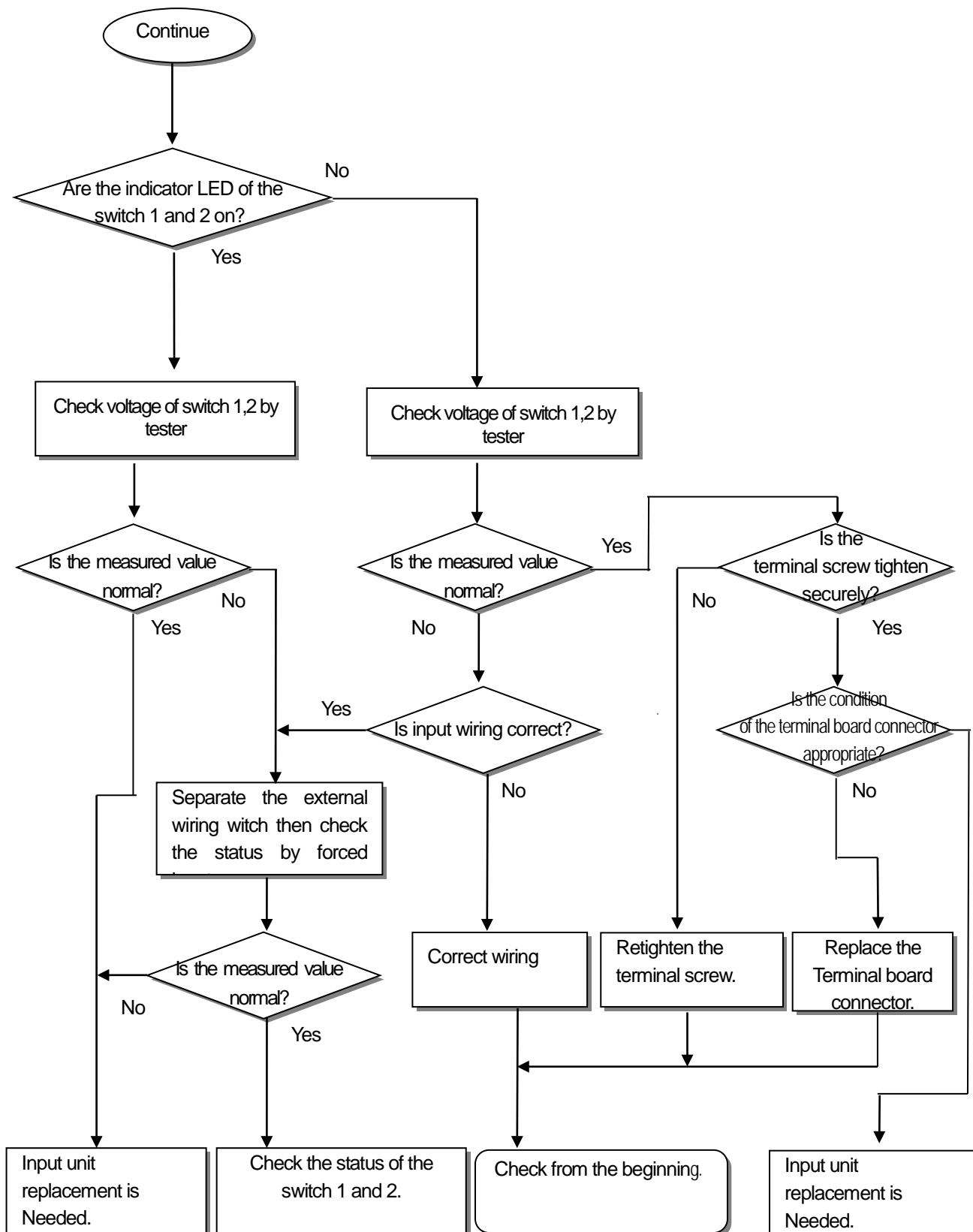

### 6.3 Troubleshooting Questionnaire

If any problem occurs during the operation of XGB series, please write down this Questionnaires and contact the service center via telephone or facsimile.

- For errors relating to special or communication modules, use the questionnaire included in the User's manual of the unit.

1. Telephone & FAX No

Tell)

FAX)

2. Using equipment model:

3. Details of using equipment

CPU model: ( ) OS version No.: ( ) Serial No. ( )

XG5000 (for program compile) version No.: ( )

4. General description of the device or system used as the control object:

5. The kind of the base unit:

- Operation by the mode setting switch ( ),
- Operation by the XG5000 or communications ( ),
- External memory module operation ( ),

6. Is the ERR. LED of the CPU module turned On ? Yes ( ), No ( )

7. XG5000 error message:

8. History of corrective actions for the error message in the article 7:

9. Other tried corrective actions:

10. Characteristics of the error

- Repetitive ( ): Periodic ( ), Related to a particular sequence ( ), Related to environment ( )
- Sometimes ( ): General error interval:

11. Detailed Description of error contents:

12. Configuration diagram for the applied system:

## 6.4 Troubleshooting Examples

Possible troubles with various circuits and their corrective actions are explained.

### 6.4.1 Input circuit troubles and corrective actions

The followings describe possible troubles with input circuits, as well as corrective actions.

Condition	Cause	Corrective Actions
Input signal doesn't turn off.	Leakage current of external device (Such as a drive by non-contact switch)	<ul style="list-style-type: none"> <li>Connect an appropriate register and capacity, which will make the voltage lower across the terminals of the input module.</li> </ul>
Input signal doesn't turn off. (Neon lamp may be still on)	Leakage current of external device (Drive by a limit switch with neon lamp)	<ul style="list-style-type: none"> <li>CR values are determined by the leakage current value.</li> <li>– Recommended value C : <math>0.1 \sim 0.47 \mu\text{F}</math></li> <li>R: <math>47 \sim 120 \Omega</math> (1/2W)</li> <li>Or make up another independent display circuit.</li> </ul>
Input signal doesn't turn off.	Leakage current due to line capacity of wiring cable.	<ul style="list-style-type: none"> <li>Locate the power supply on the external device side as shown below.</li> </ul>
Input signal doesn't turn off.	Leakage current of external device (Drive by switch with LED indicator)	<ul style="list-style-type: none"> <li>Connect an appropriate register, which will make the voltage higher than the OFF voltage across the input module terminal and common terminal.</li> </ul>

## Chapter 6 Troubleshooting

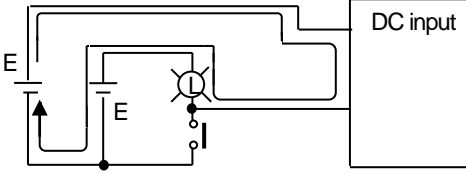
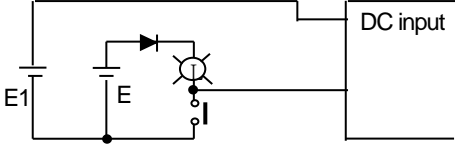
<p>Input signal doesn't turn off.</p>	<ul style="list-style-type: none"> <li>Sneak current due to the use of two different power supplies.</li> </ul>  <p>• E1 &gt; E2, sneaked.</p>	<ul style="list-style-type: none"> <li>Use only one power supply.</li> <li>Connect a sneak current prevention diode.</li> </ul> 
---------------------------------------	---	--

## 6.4.2 Output circuit and corrective actions

The following describes possible troubles with output circuits, as well as their corrective actions.

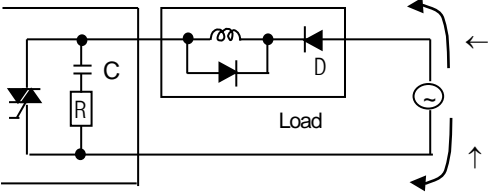
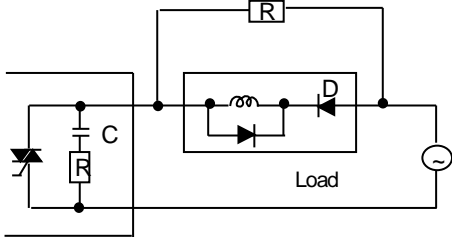
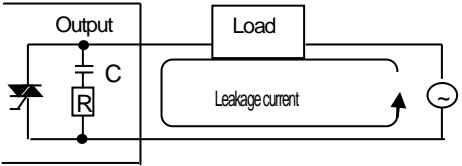
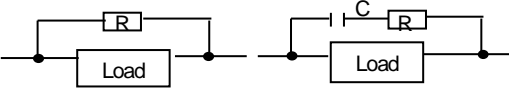
Condition	Cause	Corrective Action
<p>When the output is off, excessive voltage is applied to the load.</p>	<ul style="list-style-type: none"> <li>Load is half-wave rectified inside (in some cases, it is true of a solenoid)</li> <li>When the polarity of the power supply is as shown in ①, C is charged. When the polarity is as shown in ②, the voltage charged in C plus the line voltage are applied across D. Max. voltage is approx. <math>2\sqrt{2}</math>.</li> </ul>  <p>*) If a resistor is used in this way, it does not pose a problem to the output element. But it may make the performance of the diode (D), which is built in the load, drop to cause problems.</p>	<ul style="list-style-type: none"> <li>Connect registers of tens to hundreds K<math>\Omega</math> across the load in parallel.</li> </ul> 
<p>The load doesn't turn off.</p>	<ul style="list-style-type: none"> <li>Leakage current by surge absorbing circuit, which is connected to output element in parallel.</li> </ul> 	<ul style="list-style-type: none"> <li>Connect C and R across the load, which are of registers of tens K<math>\Omega</math>. When the wiring distance from the output module to the load is long, there may be a leakage current due to the line capacity.</li> </ul> 

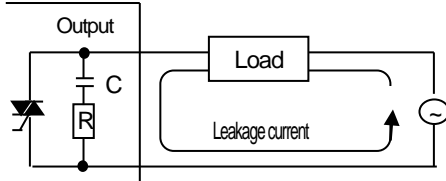
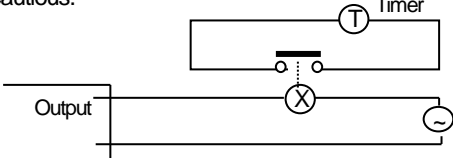
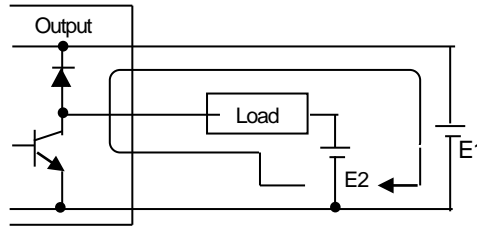
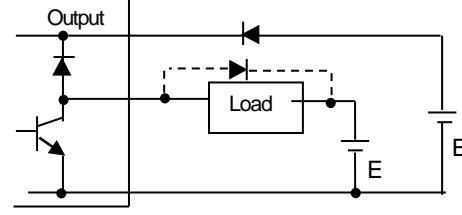
<p>When the load is C-R type timer, time constant fluctuates.</p>	<ul style="list-style-type: none"> <li>Leakage current by surge absorbing circuit, which is connected to output element in parallel.</li> </ul> 	<ul style="list-style-type: none"> <li>Drive the relay using a contact and drive the C-R type timer using the since contact.</li> <li>Use other timer than the C-R contact some timers have half-wave rectified internal circuits therefore, be cautious.</li> </ul> 
<p>The load does not turn off.</p>	<ul style="list-style-type: none"> <li>Sneak current due to the use of two different power supplies.</li> </ul>  <p><math>E1 &lt; E2</math>, sneaks. E1 is off (E2 is on), sneaks.</p>	<ul style="list-style-type: none"> <li>Use only one power supply.</li> <li>Connect a sneak current prevention diode.</li> </ul>  <p>If the load is the relay, etc, connect a counter-electromotive voltage absorbing code as shown by the dot line.</p>

Output circuit troubles and corrective actions (continued).

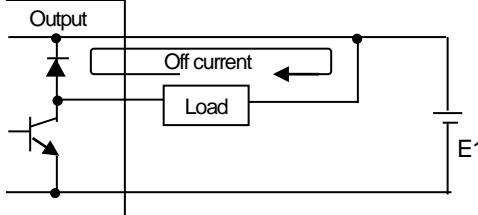
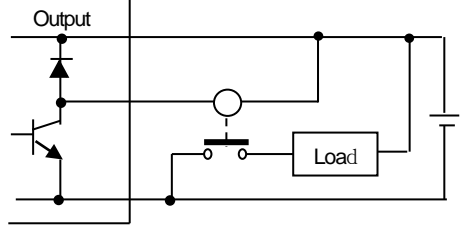
Condition	Cause	Corrective actions
<p>The load off response time is long.</p>	<ul style="list-style-type: none"> <li>Over current at off state [The large solenoid current fluidic load (L/R is large) such as is directly driven with the transistor output.</li> </ul>  <ul style="list-style-type: none"> <li>The off response time can be delayed by one or more second as some loads make the current flow across the diode at the off time of the</li> </ul>	<ul style="list-style-type: none"> <li>Insert a small L/R magnetic contact and drive the load using the same contact.</li> </ul> 

Chapter 6 Troubleshooting

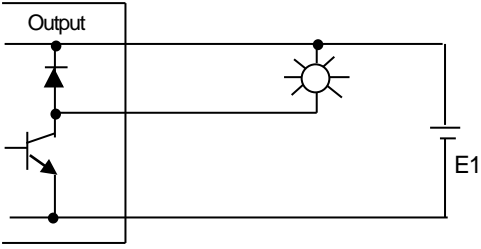
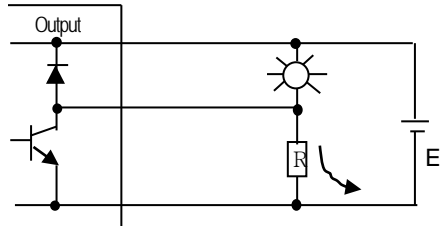
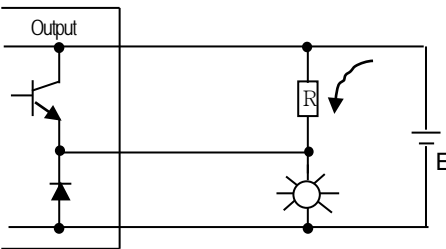
<p>Output transistor is destroyed.</p>	<p>transistor output.</p> <p>Surge current of the white lamp on.</p>  <p>A surge current of 10 times or more when turned on.</p>	<ul style="list-style-type: none"> <li>To suppress the surge current make the dark current of 1/3 to 1/5 rated current flow.</li> </ul>  <p>Sink type transistor output</p>  <p>Source type transistor output</p>
--	---	--



## 6.5 Error Code List

Error code (Dec)	Error cause	Action (restart mode after taking an action)	Operation status	LED status	Diagnosis point
23	Program to execute is abnormal	Start after reloading the program	Warning	0.5 second Flicker	RUN mode
24	I/O parameter error	Start after reloading I/O parameter, Battery change if battery has a problem. Check the preservation status after I/O parameter reloading and if error occurs, change the unit.	Warning	0.5 second Flicker	Reset RUN mode switching
25	Basic parameter error	Start after reloading Basic parameter, Change battery if it has a problem. Check the preservation status after Basic parameter reloading and if error occurs, change the unit.	Warning	0.5 second Flicker	Reset RUN mode switching
26	Compile error exceed	Reduce the program and down.	Heavy error	0.1 second Flicker	RUN mode switching
27	Compile error	Check the program	Heavy error	0.1 second Flicker	RUN mode switching
30	Module set in parameter and the installed module does not match	modify the module or parameter and then restart.	Warning	0.5 second Flicker	RUN mode switching
31	Module falling during operation or additional setup	After checking the position of attachment/detachment of expansion module during Run mode	Warning	0.1 second Flicker	Every scan
33	Data of I/O module does not access normally during operation.	After checking the position of slot where the access error occurs by XG5000, change the module and restart (acc.to parameter.)	Heavy error	0.1 second Flicker	Scan end
34	Normal access of special/link module data during operation not available	After checking the position of slot that access error occurred by XG5000, change the module and restart (acc.to parameter).	Heavy error	0.1 second Flicker	Scan end
38	Extension Module exceed	Extension module is attached over 10 slot or communication module is attached over 3 slot	Heavy error	0.1 second Flicker	RUN mode switching
39	Abnormal stop of CPU or malfunction	Abnormal system end by noise or hard ware error. 1) If it occurs repeatedly when power reinput, request service center 2) Noise measures	Heavy error	0.1 second Flicker	Ordinary time
40	Scan time of program during operation exceeds the scan watchdog time designated by parameter.	After checking the scan watchdog time designated by parameter, modify the parameter or the program and then restart.	Warning	0.5 second Flicker	While running the program

## Chapter 6 Troubleshooting

Error code (Dec)	Error cause	Action (restart mode after taking an action)	Operation status	LED status	Diagnosis point
41	Operation error occurs while running the user program.	Remove operation error → reload the program and restart.	Warning	0.5 second Flicker	While running the program
44	Timer index user error	After reloading a timer index program modification, start	Warning	0.5 second Flicker	Scan end
50	Heavy error of external device	Refer to Heavy error detection flag and modifies the device and restart. (Acc. Parameter)	Heavy error	1 second Flicker	Scan end
55	Task confliction	Check task occurrence	Heavy error	0.5second Flicker	Every time
60	E_STOP function executed	After removing error causes which starts E_STOP function in program, power reinput	Heavy error	1 second Flicker	While running the program
500	Data memory backup not possible	If not error in battery, power reinput Remote mode is switched to STOP mode.	Warning	1 second Flicker	Reset
501	Abnormal clock data	Setting the time by XG5000 if there is no error	Warning	0.1 second Flicker	Ordinary time
502	Battery voltage falling	Battery change at power On status	Warning	0.1 second Flicker	Ordinary time



## Chapter 7 EMC Standard

The following explains contents, diagnosis and corrective actions for various errors that can occur during system operation.

### 7.1 Requirements for Conformance to EMC Directive

The EMC Directive specifies the products must "be so constructed that they do not cause excessive electromagnetic interference (emissions) and are not unduly affected by electromagnetic interference (immunity)". The applicable products are requested to meet these requirements.

This section summarizes the precautions on conformance to the EMC Directive of the machinery assembled using PLC XGB series. The details of these precautions are based on the requirements and the applicable standards control. However, LS ELECTRIC will not guarantee that the overall machinery manufactured according to the these details conforms to the below-described directives. The method of conformance to the EMC directive and the judgment on whether or not the machinery conforms to the EMC Directive must be determined finally by the manufacturer of the machinery.

#### 7.1.1 EMC Standard

The standards applicable to the EMC Directive are listed below.

Table13-1

Specification	Test item	Test details	Standard value
EN50081-2	EN55011 Radiated noise * 2	Electromagnetic emissions from the product are measured	30~230 MHz QP : 50 dB $\mu$ V/m * 1 230~1000 MHz QP : 57 dB $\mu$ V/m
	EN55011 Conducted noise	Electromagnetic emissions from the product to the power line is measured	150~500 kHz QP : 79 dB Mean: 66 dB 500~230 MHz QP : 73 dB Mean: 60 dB
EN61131-2	EN61000-4-2 Electrostatic immunity	Immunity test in which static electricity is applied to the case of the equipment	15 kV Aerial discharge 8 kV Contact discharge
	EN61000-4-4 Fast transient burst noise	Immunity test in which burst noise is applied to the power line and signal lines	Power line: 2 kV Digital I/O : 1 kV Analog I/O, signal lines: 1 kV
	EN61000-4-3 Radiated field AM modulation	Immunity test in which field is irradiated to the product	10V/m, 26~1000 MHz 80%AM modulation @ 1 kHz
	EN61000-4-12 Damped oscillatory wave immunity	Immunity test in which a damped oscillatory wave is superimposed on the power line	Power line: 1 kV Digital I/O (24V or higher): 1 kV

\* 1) QP: Quasi-peak value, Mean: Average value

\* 2) The PLC is an open type device (device installed to another device) and must be installed in a conductive control panel. The tests for the corresponding items were performed while the PLC was installed inside a control panel.

## 7.1.2 Control Panel

The PLC is an open type device (device installed to another device) and must be installed in a control panel. This is needed to prevent electric shock by touching XGB PLC and reduce the PLC-generated noise. Install the XGB PLC in a metallic panel to reduce PLC-generated EMI (Electro-magnetic interference),

The specifications for the control panel are as follows:

### (1) Control panel

The PLC control panel must have the following features:

- (a) Use SPCC (Cold Rolled Mild Steel) for the control panel.
- (b) The steel plate should be thicker than 1.6mm.
- (c) Use isolating transformers to protect the power supply from external surge voltage.
- (d) The control panel must have a structure which the radio waves does not leak out.

For example, make the door as a box-structure so that the panel body and the door are overlapped each other. This structure reduces the surge voltage generate by PLC.

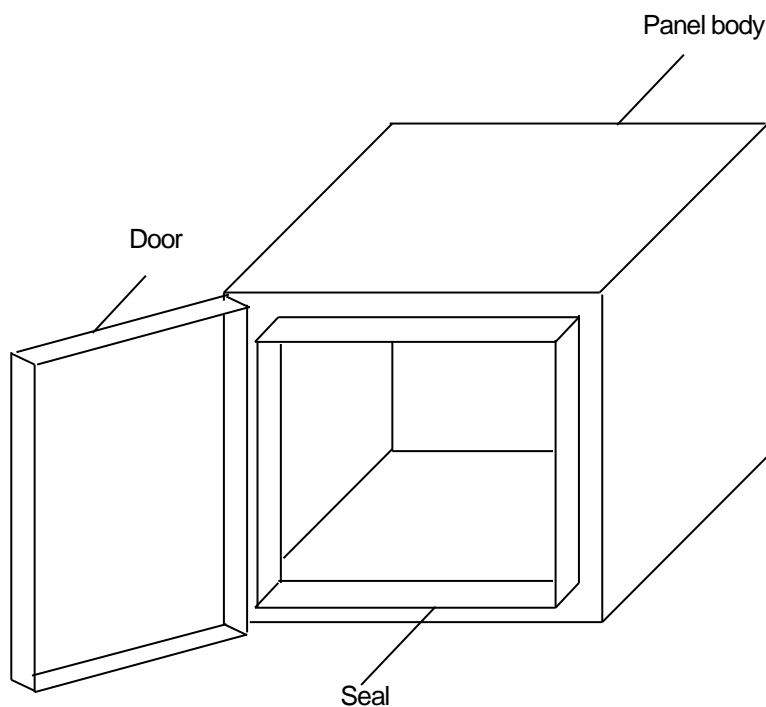

- (e) To ensure good electrical contact with the control panel or base plate, mask painting and weld so that good surface contact can be made between the panel and plate.

### (2) Connection of power and earth wires

Earthing and power supply wires for the PLC system must be connected as described below.

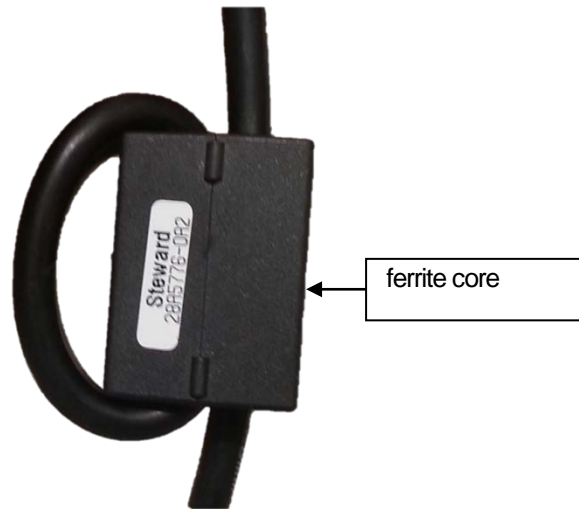

- (a) Earth the control panel with a thick wire so that a low impedance connection to ground can be ensured even at high frequencies.
- (b) The function of LG (Line Ground) and FG (Frame Ground) terminals is to pass the noise generated in the PLC system to the ground, so an impedance that is as low as possible must be ensured.
- (c) The earthing wire itself can generate the noise, so wire as short and thick to prevent from acting as an antenna.
- (d) Attach ferrite core under the power cable to satisfy CE specification.

[ferrite core]

manufacture	name	External Dimension (mm)				maximum cable diameter (mm)	address
		A	B	C	D		
Laird	28A3851-0A2	30.00	13.00	33.70	30.00	12.85	www.lairdtech.com
Laird	28A5776-0A2	29.20	20.00	42.00	42.00	19.40	www.lairdtech.com
Coilmaster	C2L RU130B	31.50	13.00	33.00	31.50	13.00	www.coilmaster.com.tw
TDK	ZCAT3035-1330	30.00	13.00	34.00	30.00	13.00	www.tdk.com

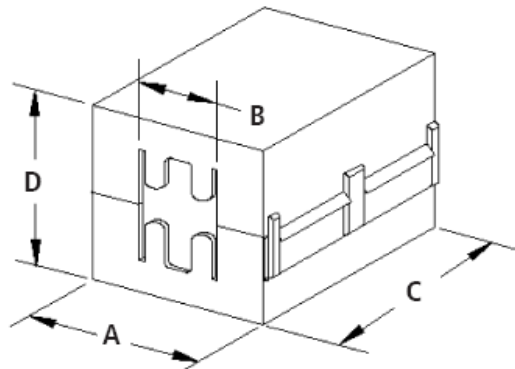

## 7.2 Requirement to Conform to the Low-voltage Directive

The low-voltage directive requires each device that operates with the power supply ranging from 50V to 1000VAC and 75V to 1500VDC to satisfy the safety requirements. Cautions and installation and wiring of the PLC XGB series to conform to the low-voltage directive are described in this

section.

The described contents in this manual are based on the requirements and the applicable standards control. However, LS ELECTRIC will not guarantee that the overall machinery manufactured according to the these details conforms to the above regulation. The method of conformance to the EMC directive and the judgment on whether or not the machinery conforms to the EMC Directive must be determined finally by the manufacturer of the machinery.

## 7.2.1 Standard Applied for XGB Series

The XGB series follow EN6100-1 (safety of devices used in measurement rooms, control rooms, or laboratories). And the XGB series modules which operate at the rated voltage of AC50V/DC75V or above are also developed to conform the above standard.

## 7.2.2 XGB Series PLC Selection

### (1) Power and CPU

There are dangerous voltages (voltages higher than 42.4V peak) inside the power supply modules of the AC110/220V rated I/O voltages. Therefore, the CE mark-compliant models are enhanced in insulation internally between the primary and secondary.

### (2) I/O module

There are dangerous voltages (voltages higher than 42.4V peak) inside the I/O modules of the AC110/220V rated I/O voltages. Therefore, the CE mark-compliant models are enhanced in insulation internally between the primary and secondary.

The I/O modules of DC24V or less rating are out of the low-voltage directive application range.

### (3) Special module, Communication module

The special module and communication modules are DC24V or less in rated voltage, therefore they are out of the low-voltage directive application range.

## Part 2. Basic Functions

This Chapter covers the details of programming and operations, monitoring of the high performance XGB basic unit

### Chapter 1 Program Configuration and Operation Method

#### 1.1 Programming Basics

##### 1.1.1 Programming Method

The XBC high performance basic unit supports programming method of repetitive operation interrupt operation, fixed operation.

###### (1) Repetitive operation mode (Scan)

It means the basic programming method of the PLC.

It is the method that performs the written program repetitively from the first step to the last one and a series of such procedures is called 'program scan'. A series of such processing is called the repetitive operation mode and it can be divided as below.

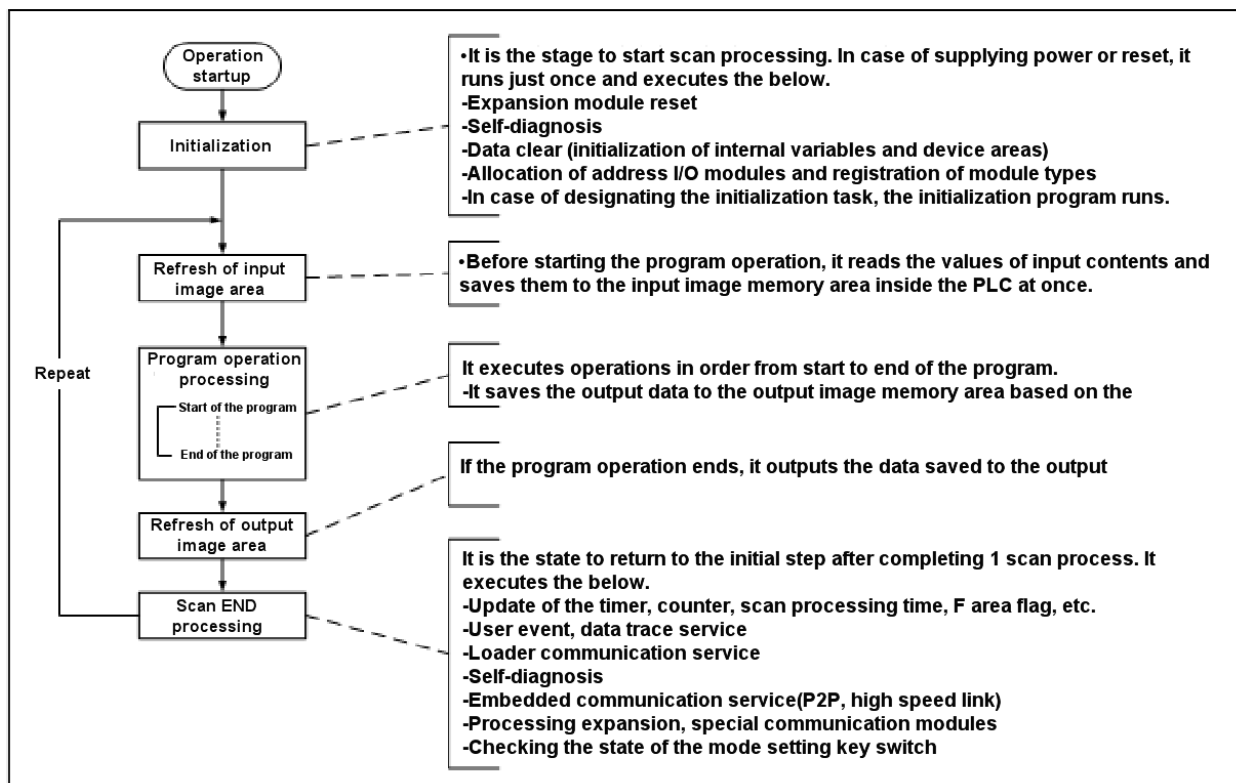



## (2) Interrupt operation mode (fixed cycle, external interrupt, internal device start, high speed counter)

It is the mode that suspends the currently executed scan program operation and handles the interrupt program immediately when urgent priority matter occurs during execution of the PLC scan program. The signals that inform the CPU of such interrupt occurrence is called 'interrupt signal' and there are 4 kinds as below. For more details on each interrupt operation, refer to Section 1.1.5 ~ 1.1.10.

- Fixed cycle signal: Interrupt signal occurring at the fixed interval
- External input signal: External contact (P0008~0000F) input signal
- Internal device: In case the internal device value is matched with the set occurrence condition
- High speed counter: In case the high speed counter current value is matched with the set value

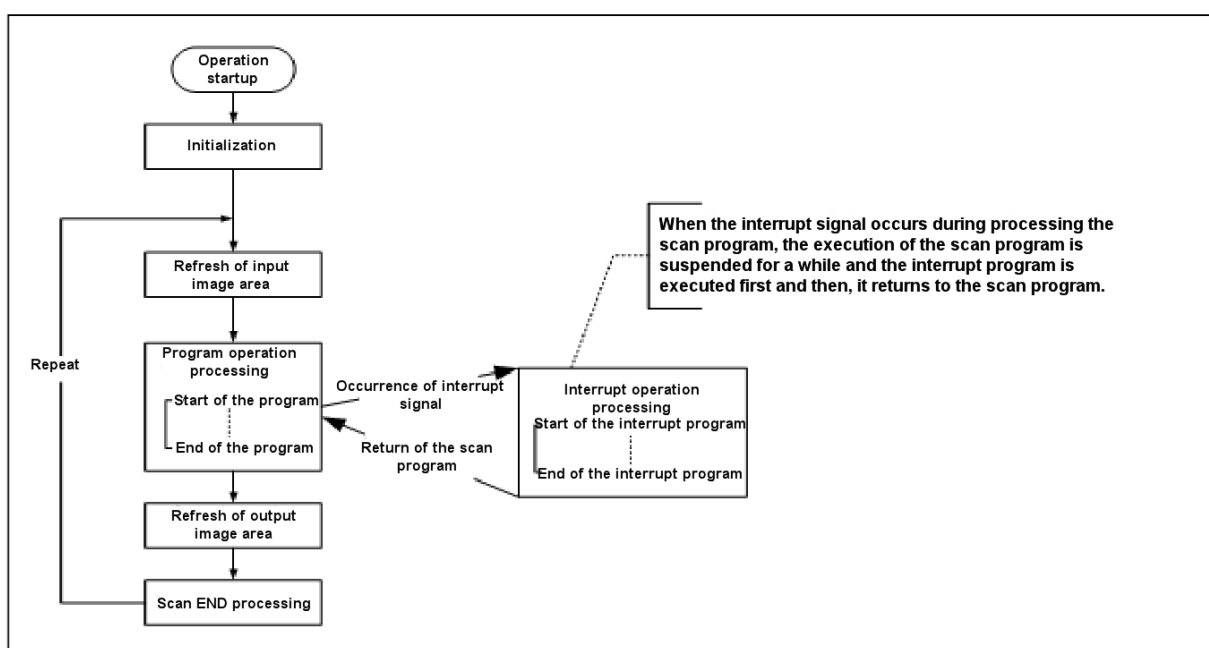

## (3) Fixed Cycle Operation mode

It is the mode that executes the scan program every fixed time.

After executing all scan programs, it stands by until the fixed cycle time and then, the next scan will resume at the specified time.

At this time, the current scan time displayed in F area indicates the net program processing time except waiting time.

If the actual scan program processing time is longer than the fixed cycle, fixed cycle error flag will be turned On. The flags related to fixed cycle operation are as below.

Bit	Flag Name	Name	Description
F005C	_CONSTANT_ER	Fixed cycle error	In case the actual scan time is longer than the fixed cycle set value
F0080	_CONSTANT_RUN	Fixed cycle operation is running	Turned ON during fixed cycle operation

### 1.1.2 Execution processing in case of instantaneous interruption

If the input power voltage supplied to XGB basic unit is lower than the specification, the PLC will detect instantaneous interruption.

When the PLC detects instantaneous interruption, the following execution processing will run.

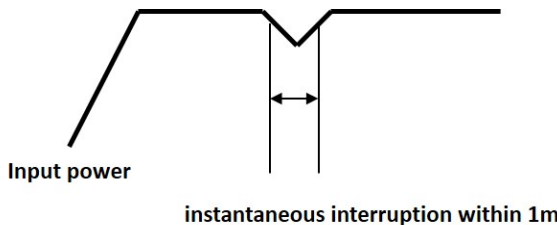
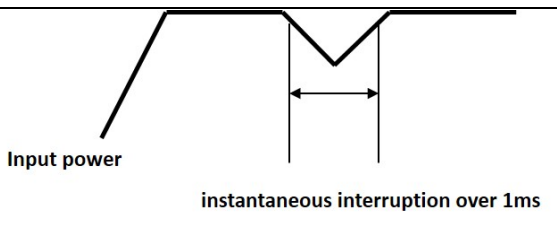
Blackout time	Execution processing
 <p>Input power</p> <p>instantaneous interruption within 1ms</p>	<p>(1) Execution is interrupted, maintaining output state of when instantaneous interruption occurred.</p> <p>(2) If instantaneous interruption is canceled, execution will resume.</p> <p>(3) In case execution is suspended due to instantaneous interruption, timer measurement and one for fixed cycle interrupt will be continuously run.</p>
 <p>Input power</p> <p>instantaneous interruption over 1ms</p>	<p>(1) If instantaneous interruption exceeds 1ms, the PLC will execute restart like the time when power is supplied.</p>

The below figure shows the PLC's execution processing flow chart when instantaneous interruption occurs.

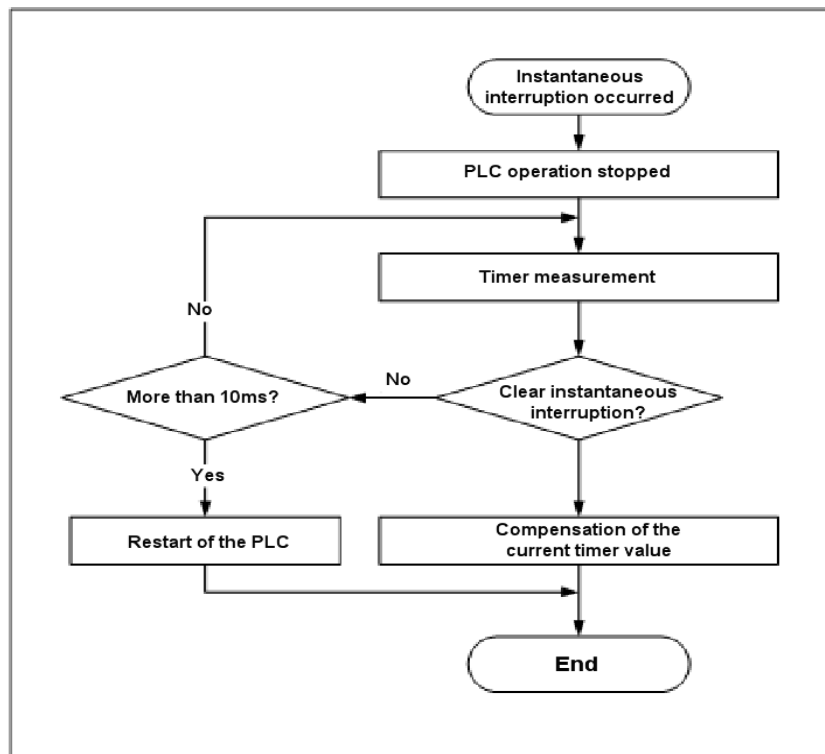

#### Notice

Instantaneous interruption means the state that the PLC exceeds the allowable variation range of the specified power and is lower than the range. The brief (several ms ~ dozens of ms) blackout is called instantaneous interruption.

### 1.1.3 Scan Time

The scan time is the time that takes to complete a single control operation from step 0 of the full scan program to step 0 of the next scan; it is directly connected to the system's control performance.

#### (1) Scan time formula

The scan time is the sum of the process time of the scan program and interrupt program written by a user and the PLC's internal END processing time; it can be calculated by the below formula.

(a) Scan time = scan program processing time + interrupt program processing time + PLC internal processing time

- Scan program processing time = Processing time of the user program excluding the interrupt program
- Interrupt program processing time = Sum of the interrupt program running time processed for 1 scan
- PLC internal processing time = Self-diagnosis time + I/O refresh time + internal data processing time + communication service processing time (processing XG5000 service and embedded communication)

Model	MPU processing time		Expansion interface processing time		
	Scan program running (32K)	PLC internal Processing time	Digital I/O module (32 points, 1 EA)	Analog module (8 channels, 1EA)	Communication module (200 byte, 1 block)
XBM-DN32H	8.3 ms	0.8ms	0.3ms	2.0ms	0.8ms

XBM 'H' unit performs the control operation based on the below sequence. Accordingly, you can estimate the rough control performance of the system to be designed by using the below calculation method.

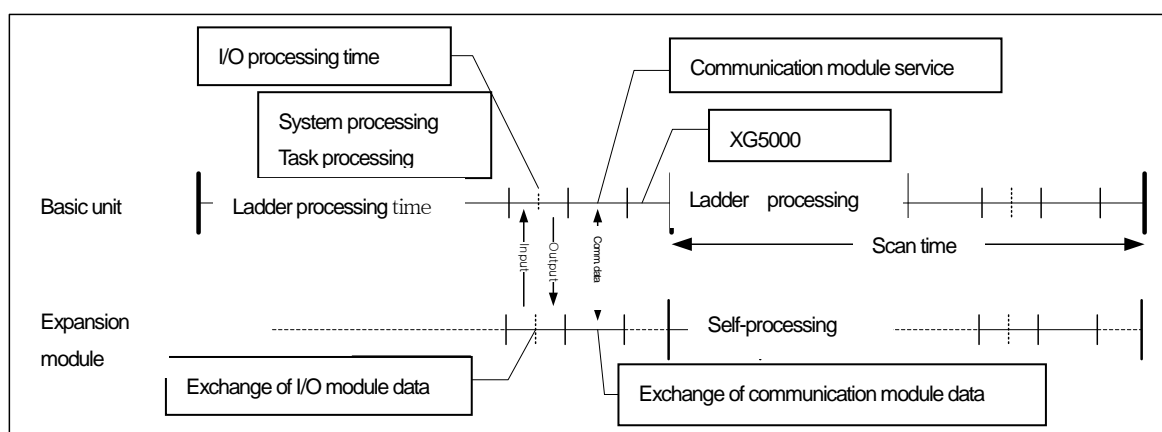

Scan time = Ladder running time + system processing time + digital module I/O processing time + analog I/O processing time + communication module processing time + XG5000 Service processing time

## Chapter 1 Program Configuration and Operation Method

### (2) Example of calculating the scan time

The example of the high performance XGB PLC's system configuration and the calculation result of the scan time are as follows.

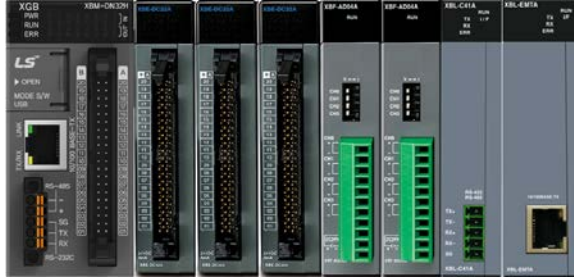

Items	System Configuration							
	Basic unit	SLOT2	SLOT3	SLOT4	SLOT5	SLOT6	SLOT7	SLOT8
Product name	XBM-DN32H	XBE-DC32A * 3EA			XBF-AD04A * 2EA		XBL-C41A	XBL-EMTA
Operating conditions	20kStep	-			-		200 Byte per module, 1 block	

Scan time = Ladder running time + system processing time + digital I/O processing time + analog I/O processing time + communication module processing time + XG5000 Service processing time = 8.3 + 0.8 + 0.3\*3 + 2.0\*2 + 0.8\*2 + 0.1μs = 15.1ms

However, in the event of changing during RUN or writing communication parameters with XG5000, it requires converting the program changed during RUN into executable machine code in the PLC or other internal processing operations for changed communication parameters so the scan time may be temporarily increased by several ms or more.

### (3) Verification of the scan time

The PLC's scan time can be verified by using XG5000 or flag as below.

(a) How to use XG5000: Click 『Online』 - 『Diagnosis』 - 『PLC information』 - 『Performance』 .

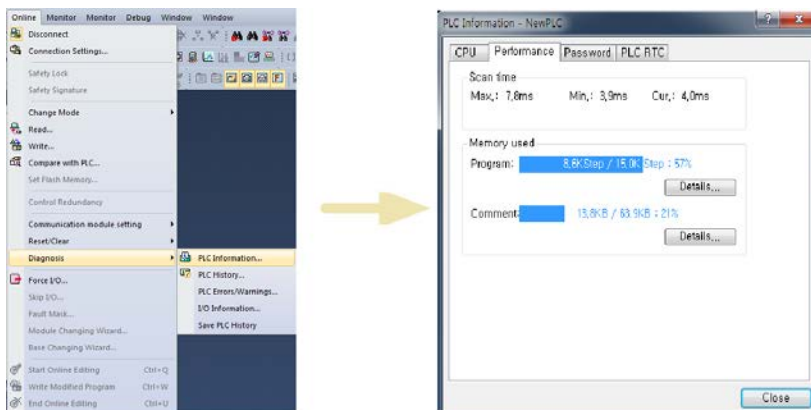

(b) How to use flag : The scan time is saved in the below system flag (F) area.

WORD	Flag Name	Name	Description
F0050	_SCAN_MAX	Maximum scan time	The longest scan time (update in case of occurrence only), in 0.1ms
F0051	_SCAN_MIX	Minimum scan time	The shortest scan time (update in case of occurrence only), in 0.1ms
F0052	_SCAN_MAX	Current scan time	Running time of this scan (scan update), in 0.1ms

### 1.1.4 Program Composition

The program is composed of all function factors required to perform a specific control and they are saved in the basic unit's RAM or flash memory. The function factors to execute the program can be generally divided as below.

Function factors	Executing details
Initialization program	<ul style="list-style-type: none"> <li>• After applying power, it is the program that is firstly executed after completing the self-initialization operations required to operate the PLC. It should run until the INIT_DONE command executes.</li> <li>• When the initialization program runs, only the initialization program is available until the INIT_DONE command runs; the scan program and fixed cycle, external interrupt, internal device task program are not executed. All other embedded functions such as I/O refresh, high speed counter, communication are normally executed.</li> <li>• It is used to program various operations required for the initial settings of the system configured with the high performance XGB PLC.</li> </ul>
Scan program	<ul style="list-style-type: none"> <li>• Repeated regularly at every scan. It performs the operation repetitively from the first step to the last step in order of being written.</li> <li>• If the fixed cycle interrupt, external contact interrupt, high speed counter interrupt occur during execution of the scan program, it will stop the scan program and return to the scan program after executing the relevant interrupt program.</li> </ul>
Fixed cycle interrupt program	<ul style="list-style-type: none"> <li>• Executed at every set cycle regardless of the scan program. It can be applied to execute the following time conditions. <ul style="list-style-type: none"> <li>▶ Execution at the shorter time interval than 1 scan processing time</li> <li>▶ Execution at the longer time interval than 1 scan processing time</li> <li>▶ Execution at the fixed time interval</li> </ul> </li> </ul>
External contact interrupt program	<ul style="list-style-type: none"> <li>• Executed every time the input conditions (rising edge, falling edge, transition) of the set external input signal occur. It can be applied when immediate execution is required for external input conditions.</li> </ul>
High speed counter interrupt program	<ul style="list-style-type: none"> <li>• Executed when the high speed counter's current value is matched with the set value.</li> </ul>
Internal device interrupt program	<ul style="list-style-type: none"> <li>• Executed when the set internal device is matched with relational conditions.</li> <li>• Detects whether starting conditions of the internal device interrupt occurs during END after executing the scan program</li> </ul>
Subroutine program	<ul style="list-style-type: none"> <li>• Executed only when the input condition of the CALL command is On.</li> </ul>

#### Notice

- 1) Make the interrupt program as shortly as possible. In case the same interrupt occurs repeatedly during executing the interrupt program, O/S watchdog error may occur with non-execution of the scan program.  
(In case the self-interrupt occurs during executing the interrupt program, task conflict error may occur.)
- 2) Although interrupts with low priority occur several times during executing the one with high priority, the interrupt will run just once so you should pay attention to set up the priority.

### 1.1.5 Interrupt

(1) Interrupt processing flow chart

It describes the PLC's operation flow chart, giving you the example of setting the interrupt program as below.

• Interrupt setting

Interrupt type	Interrupt Name	Priority	Task No.	Program Name	Remarks
Initialization	Interrupt0	-	-	Initialization program	
Fixed cycle 1	Interrupt1	2	0	Fixed cycle 1	
External	Interrupt2	2	16	External	
Internal device	Interrupt3	3	24	Internal device	
High speed counter	Interrupt4	4	40	High speed counter	
Fixed cycle 2	Interrupt5	3	1	Fixed cycle 2	

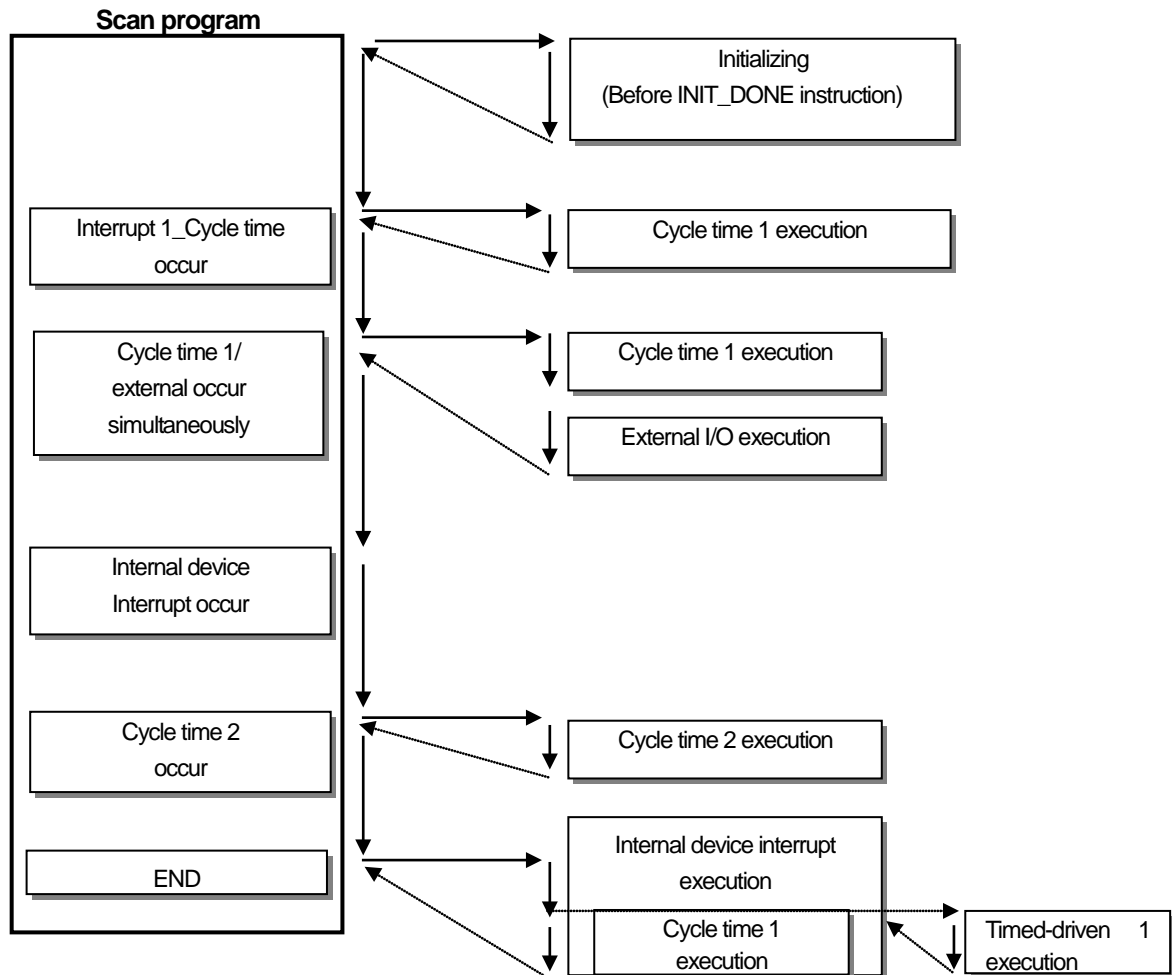

## Chapter 1 Program Configuration and Operation Method

### Notice

- 1) If the interrupt with the same priority occur at the same time, the early set interrupt will be executed first. (In case 'interrupt 1' and 'interrupt 2' occur at the same time, 'interrupt 1' will be executed first.)
- 2) If the interrupt with higher priority occurs during execution of interrupts, the interrupt with higher priority will be executed first.
- 3) All interrupts are allowable (Enable) when the power is On. If you want to run by interrupt program or prohibit them, you can use EI, DI command.
- 4) The internal device interrupt will run after getting the END command.

### (2) Types and operation standards of tasks

The types and operation standards of tasks that are available for the high performance small-sized PLC are as below.

Type Spec.	Fixed cycle task	External contact task	Internal contact task	High speed counter task
Maximum number	16 EA	8 EA	16 EA	8 EA
Start conditions	Fixed cycle (Can be set up to 4,294,967.295 seconds, in 1ms )	Rising or falling edge of the basic unit P008~P00F input contacts	Internal device's designated conditions	High speed counter comparative output 0 / The minimum set value is matched
Detection and Execution	Executed cyclically at every setting time	Executed immediately when the edge of the basic unit P008~P00F input contacts occur	Executed with searching conditions after completing the scan program	Executed when the current counter value is matched with the minimum set value of the comparative output 0
Detection delay Time	Delayed for the maximum of 1ms	Within the maximum of 0.05ms	Delayed as much as the maximum scan time	Within the maximum of 0.25ms
Priority of executions	2 ~ 7 level setting (2 level has the highest priority)	Same as the left	Same as the left	Same as the left
Task No.	Designated without overlapped users in the range of 0~15	Designated without overlapped users in the range of 16~23	Designated without overlapped users in the range of 24~39	Designated without overlapped users in the range of 40~47

### (3) Processing method of the task program

It describes the common processing methods and instructions for the task program.

#### (a) Characteristics of the task program

- In contrast with the scan program, the task program runs only when the execution conditions occur without repetition processing. When writing the task program, consider this point.

For example, if the timer and counter are applied to the task program with the fixed cycle of 10 seconds, the maxim error of 10 seconds may occur in the timer. The counter reflects the input state every 10 seconds so the input that changed within 10 seconds is not counted.

#### (b) Execution priority

- In case several tasks to be executed stand by, the task program with high priority should be processed first. If the tasks with the same priority stand by, they should be processed in order of occurrence.
- When the fixed cycle task and external contact task occur at the same time, the task set early by

## Chapter 1 Program Configuration and Operation Method

XG5000 will be executed by priority.

- Set up the priority of the task programs in consideration of characteristics, importance of the programs and urgency of required executions.

### (c) Processing delay time

The delay of task program processing is caused by the below causes. Consider these factors when setting up tasks and writing programs.

- Delayed detection of tasks (Refer to the detailed description of each task.)
- Program execution delay due to execution of the preceding task program
- Input/output data refresh of expansion special module

### (d) Relation between the initialization, scan program and the task program

- When executing the initialization task program, the fixed cycle, external contact, high speed counter, internal contact task cannot be started.
- The scan program has the lowest priority so when the task occurs, the scan program will be suspended and the task program will be executed preemptively. Accordingly, in case the tasks occur frequently during one scan or they converge intermittently, the scan time may be extended abnormally. You should consider this point when setting tasks.

### (e) Protection of the currently running scan program by prohibiting tasks execution

- If you do not want the scan program to be suspended by the task program with high priority during executing the scan program, you can partially prohibit the execution of task programs by using the below DI, EI command in order to protect the scan program.

(When the power is supplied to the PLC, the initial values of all tasks are EI (allowable) state.)

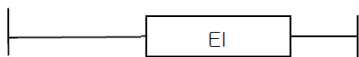
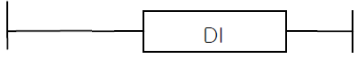
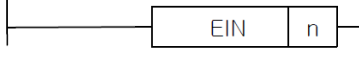
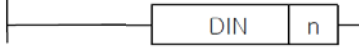
Command	Use	Description
EI		Allows the start of all tasks.
DI		Prohibits the start of all tasks.
EIN		Allows the start of the task designated as n.
DIN		Prohibits the start of the task designated as n.

### (4) Verification of task program

After writing the task program, verify it based on the following instructions.

#### (a) Are the occurrence conditions of tasks proper?

If tasks occur frequently beyond necessity or if several tasks occur in one scan, the scan time may be extended or become irregular. / If you cannot change task settings, check the maximum scan time.

#### (b) Are the priorities of tasks arranged well?

The task program with low priority may be delayed and fail to be executed in time due to the task program with high priority, in some cases, the pending tasks occur redundantly during execution of the preceding tasks so it may lead to tasks conflicts.

Set up the priority in consideration of urgency, running time, etc. of tasks.

#### (c) Are task programs made as shortly as possible?

Long running time of the task program can cause the long or irregular scan time or may lead to the conflict of task programs. Make the task programs as shortly as possible.

Especially, when attaching expansion special module, or using PUT,GET instructions, program processing might



## Chapter 1 Program Configuration and Operation Method

be delayed. (More than 10ms task cycle is recommended).

When making the task program with fixed cycle, the task program should be executed within 10% of the operation cycle of the shortest task among several tasks.

Ex.) When the task program's running time is 1ms, the fixed cycle time should be more than 10ms.

(d) Is the protection of the program needed for the task with high priority during execution of the program?

If the other task interrupts during execution of the task program, after the executing task is completed, among pending tasks, the one will run in order of priority. If you do not want interruption of other tasks during execution of the task program, protect the program with DI, EI applied commands.

### (5) Example of program configuration and processing

The example of the program execution sequence is given under the registered tasks and programs as below.

#### • Registered task programs

Interrupt source	Interrupt Name	Priority	Task No.	Program Name	running time
Fixed cycle	10ms_fixed cycle	3	0	Program1	2ms
Internal contact	Internalcontact_M00	5	24	Program2	7ms
External contact	Externalcontact_P08	2	16	Program3	2ms
-	-	-	-	Scan program	17ms

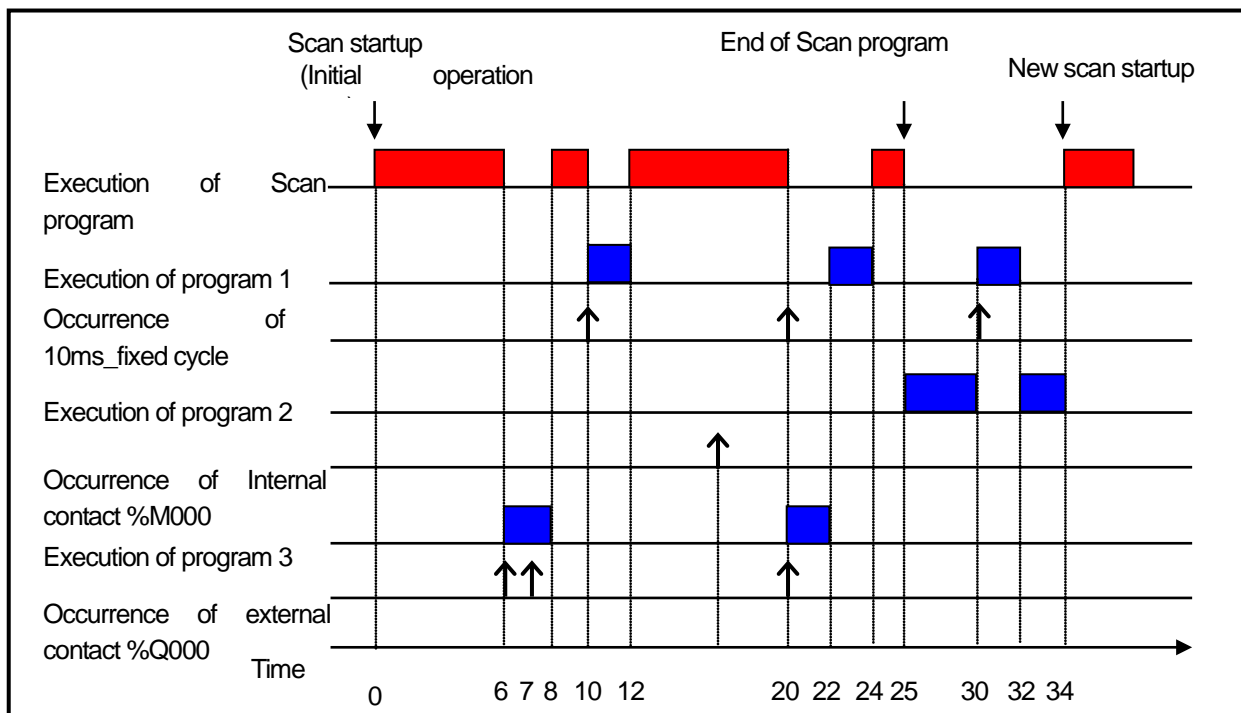

Time (ms)	Executed details
0~6	The scan program starts and is executed.
6~8	Request on running the external contact interrupt is entered and the scan program is interrupted and the program 3 runs. There is the request on rerun at 7[ms] but it is ignored since the program is running.
8~10	The execution of the program 3 is completed and the scan program will run continuously.
10~12	There is the request on running 10ms_fixed cycle interrupt so the scan program is interrupted and the program 1 runs.
12~20	The execution of the program 1 is completed and the scan program that was interrupted runs

	continuously.
20	Although there are the requests on 10ms_fixed cycle interrupt and the external contact interrupt at the same time, the external contact interrupt has higher priority so the program 3 runs and the program 1 stands by for execution.
20~22	The scan program is interrupted and the program 3 runs.
22~24	The execution of the program 3 is completed and the pending 10ms_fixed cycle interrupt program 1 runs.
24~25	The execution of the program 1 is completed and the scan program is finished.
25	The program 2 is executed by checking the interrupt request on internal contact_MO of P2 at the time of completion of the scan program.

time (ms)	Executed details
25~30	The program 2 runs.
30~32	The request on 10ms_fixed cycle interrupt occurs and the 10ms_fixed cycle has higher priority so the program 2 is interrupted and the program 1 runs.
32~34	The execution of the program 1 is completed and the program 2 that was interrupted is finished.
34	The new scan starts (startup of executing the scan program)

### 1.1.6 Initialization task

#### (1) How to set up the task

You can add initialization tasks in the project window of XG5000 as below and add the programs to be executed. For more details, refer to the XG5000 manual. (You cannot add tasks on online. After disconnecting the PLC, add tasks.)

- (a) Adding task: Select 『Project』 – 『Add Items』 – 『Task』 or after clicking with the right mouse button on the project name of the project tree, select 『Add Items』 - 『Task』 as shown in the below figure.

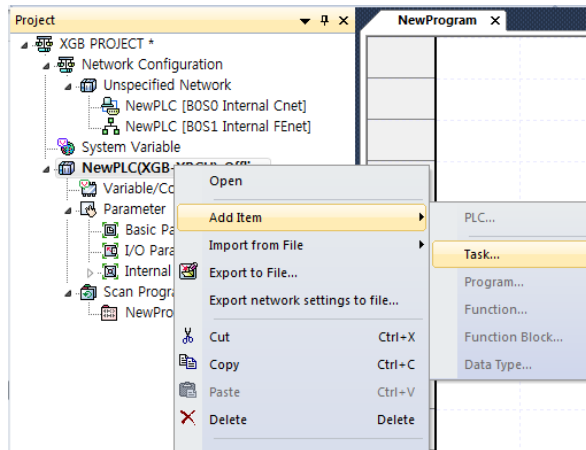

- (b) The screen for registering the task will be displayed. Click 『Initialization』 in the execution conditions and enter the task name.

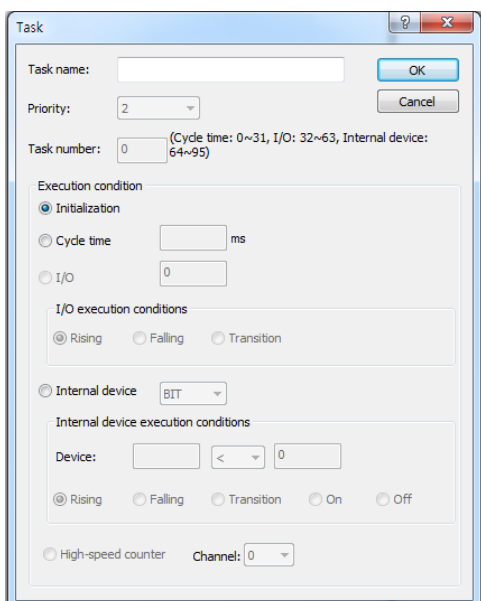

- (c) Click on the right mouse button on the registered task and click 『Add Items』 - 『Program』.

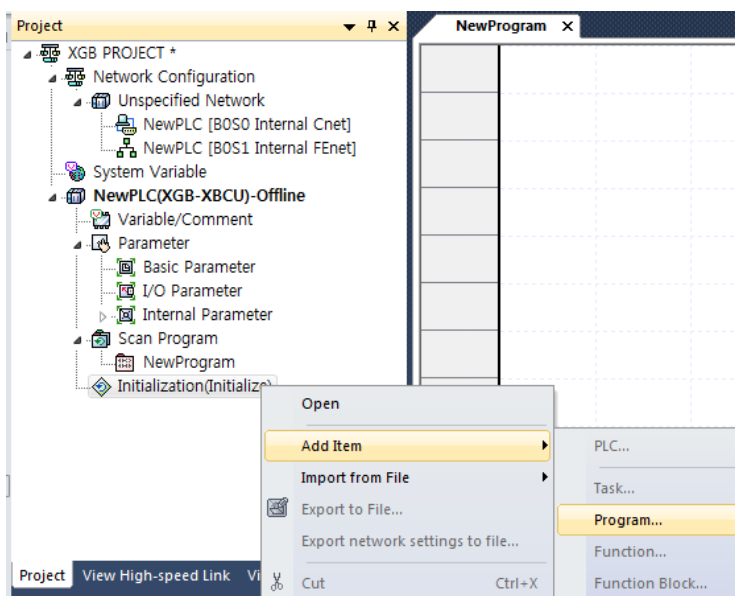

- (d) Make the necessary initialization program and make sure to include the INIT\_DONE command to the initialization task program.

(If the operation conditions of INIT\_DONE runs, the initialization task is ended and the scan program runs.)

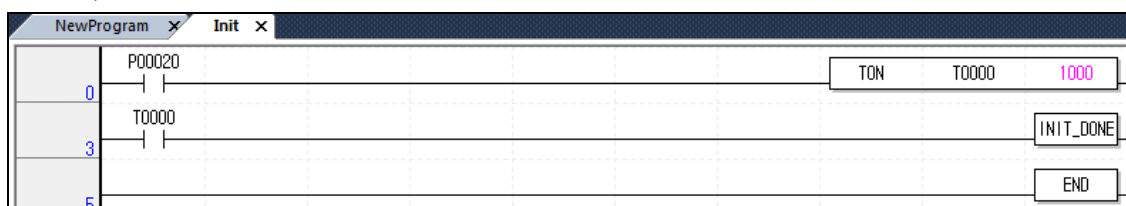

### 1.1.7 Fixed cycle task

(1) How to set up the task

- (a) Adding tasks: Select 『Project』 – 『Add Items』 – 『Task』 or after clicking with the right mouse button on the project name of the project tree, select 『Add Items』 - 『Task』 as shown in the below figure.

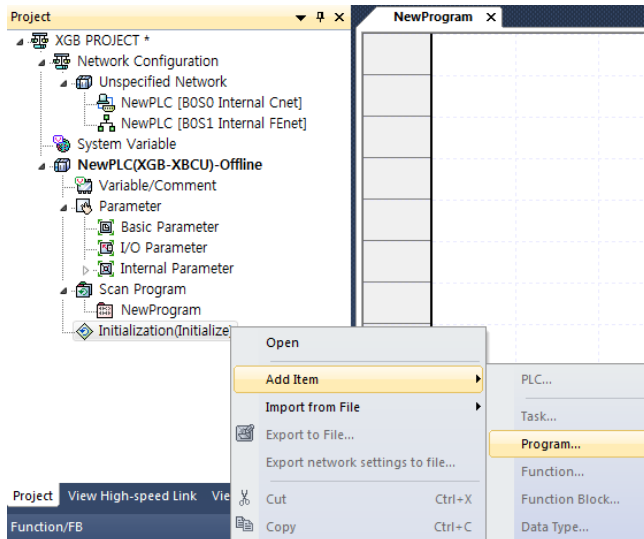

- (b) The screen for registering the task will be displayed. Click 『Fixed cycle』 in the execution conditions and after entering the task name, input the items required for setting as below

Items	Input range	Description
priority	2~7	Designates the priority of tasks.
Task No.	0~15	Designates the task number. The numbers overlapped with are not available.
cycle	1~4,294,967,295 (ms)	Designates the task's running cycle.

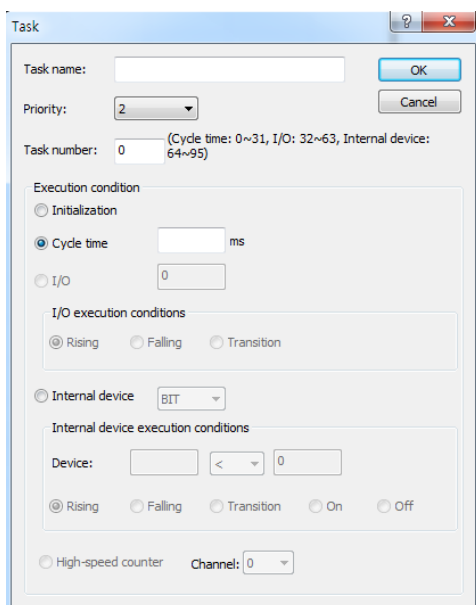

(c) Click on the right mouse button on the registered task and click 『Add Items』 - 『Program』 .

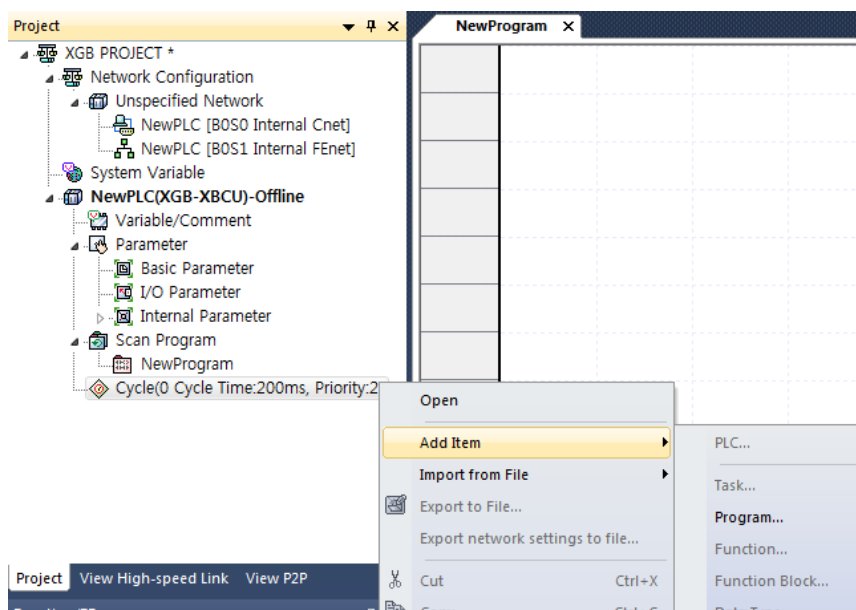

(d) Register the task program name and comment.

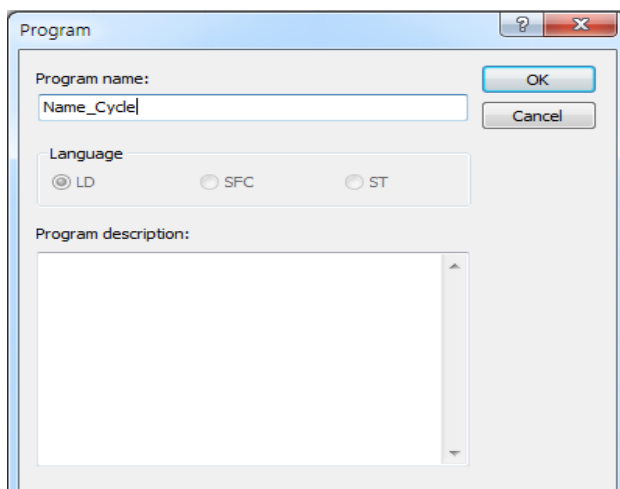

(e) If the program window for writing the task program is displayed, you can make the task program here.

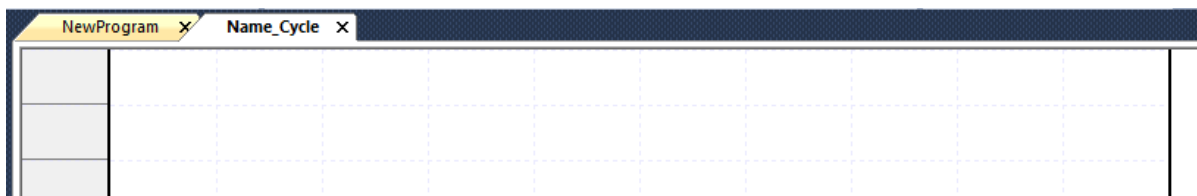

## (2) Instructions to use the fixed cycle task

The corresponding task program with fixed cycle runs at every set time interval (running cycle) and keep the below instructions in mind.

- When the specific task program with the fixed cycle runs currently or stands by for execution, if the request on running the same task program occurs, the newly occurred task will be ignored.
- The timer generating the request on running the task program with fixed cycle works only when the operation mode is RUN mode. Ignore all the blackout time.
- When setting up the running cycle of the task program with fixed cycle, the request on running several task programs should not occur.

If you apply 4 task programs with the fixed cycle of 2 seconds, 4 seconds, 10 seconds, 20 seconds, 4 execution requests occur simultaneously every 20 seconds and 4 tasks runs at once so the scan time may be longer momentarily.

### 1.1.8 External contact task

## (1) How to set up the task

- (a) Adding tasks: Select 『Project』 – 『Add Items』 – 『Task』 or after clicking with the right mouse button on the project name of the project tree, select 『Add Items』 - 『Task』 as shown in the below figure.

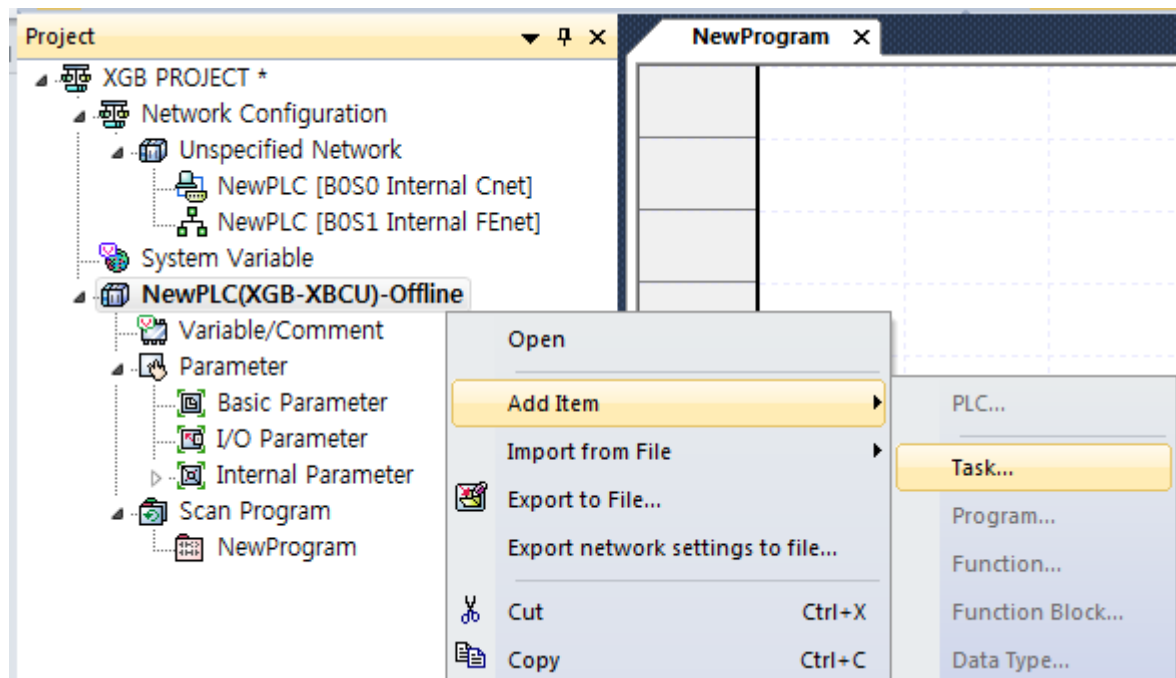

## Chapter 1 Program Configuration and Operation Method

- (b) The screen for registering the task will be displayed. Click 『External contact』 in the execution conditions and after entering the task name, input the items required for setting as below.

Items	Input range	Description
Priority	2~7	Designates the priority of tasks.
Task No.	16~23	Designates the task number. The numbers overlapped with are not available.
Contact No.	8~15	Designates the task start contact number.
Starting conditions	rising, falling, transition	Sets up starting conditions of tasks.

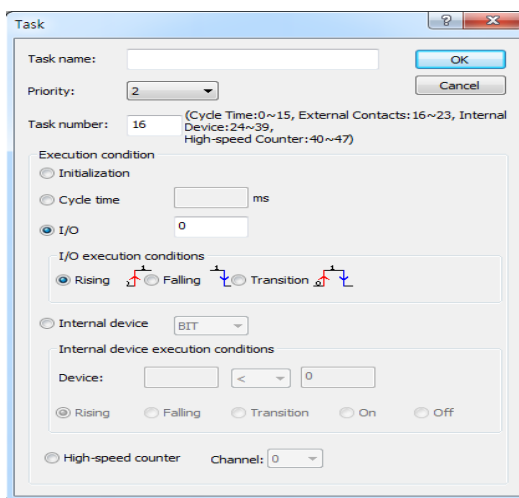

- (c) Click on the right mouse button on the registered task and click 『Add Items』 - 『Program』 .

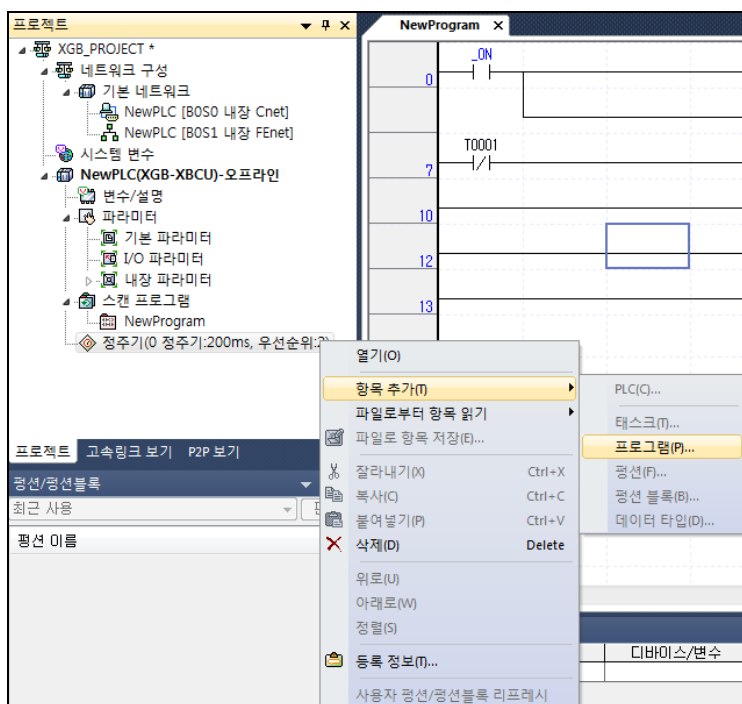

(d) Register the task program name and comment.

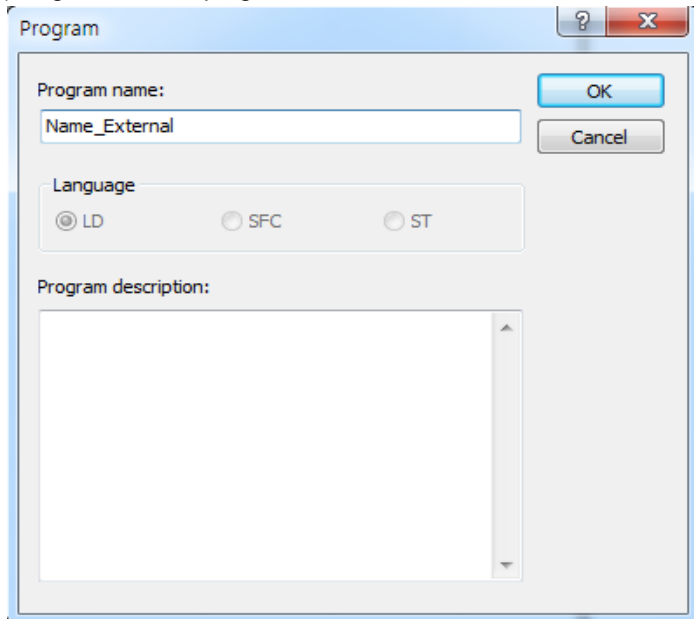

(e) If the program window for writing the task program is displayed, you can make the task program here.

### (3) Instructions to use the external contact task

When the rising, falling or transition conditions occur in the set input contact, the corresponding external contact task program runs and keep the below instructions in mind.

- 8 external contacts are available in the range of P0008~P000F.
- When the specific external contact task program runs currently or stands by for execution, if the request on running the same input task program occurs, the newly occurred task will be ignored.
- The input contact monitoring for the external contact tasks is executed only when the operation mode is RUN mode. The input contact monitoring for task startup is not executed in STOP mode.
- The detection delay time of the external contact task is approximately 50us.
- When designing the system, several external contact tasks should not start at the same time. If P0008 ~ P000F contacts are ON at the same time under all the external contacts of P0008 ~ P000F are set as the external contact tasks, 8 external contact task programs run at one so the scan time may be longer momentarily.



### 1.1.9 Internal device task

(1) How to set up the task

- (a) Adding tasks: Select 『Project』 – 『Add Items』 – 『Task』 or after clicking with the right mouse button on the project name of the project tree, select 『Add Items』 - 『Task』 as shown in the below figure.

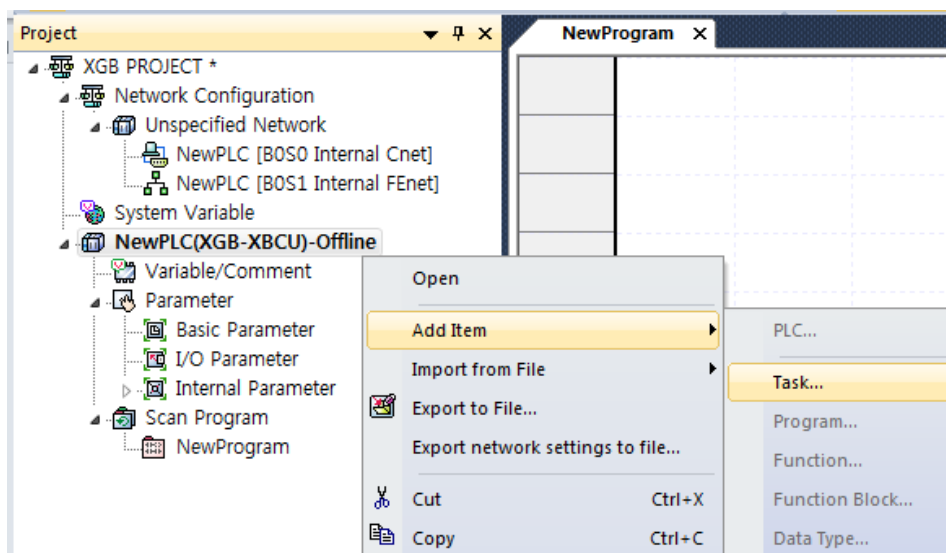

- (b) The screen for registering the task will be displayed. Click 『Internal device』 in the execution conditions and after entering the task name, input the items required for setting as below.

Items		Input range	Description	
Priority		2~7	Designates the priority of tasks..	
Task No.		24~39	Designates the task number. The numbers overlapped with are not available.	
Internal device		BIT, WORD	Selects the device type that will start the task.	
Device		Direct input	Input directly the device that will start the task and set the startup conditions.	
Startup conditions	Bit	Rising, falling, transition, On, Off	Rising	Starts the task in case of rising edge.
			Falling	Starts the task in case of falling edge.
			Transition	Starts the task in case of rising or falling edge.
			On	Starts every scan task during ON.
			Off	Starts every scan task during OFF.
	Word	<, <=, ==, >=, >	<	Starts the task when the word is less than the set value.
			<=	Starts the task when the word is less than or equal to the set value.
			==	Starts the task when the word is the same as the set value.
			>=	Starts the task when the word is more than or equal to the set value.
			>	Starts the task when the word is more than the set value.

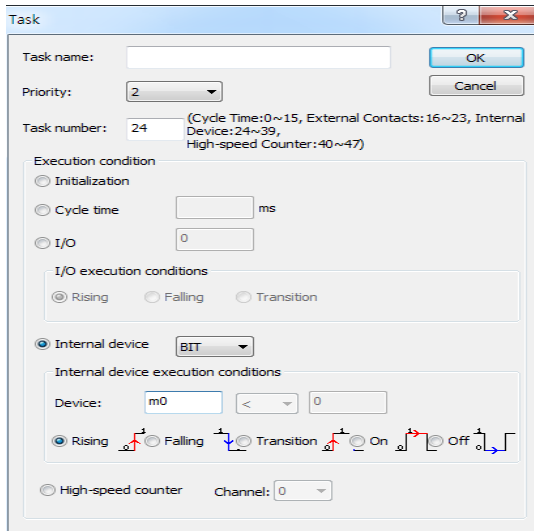

(c) Click on the right mouse button on the registered task and click 『Add Items』 - 『Program』 .

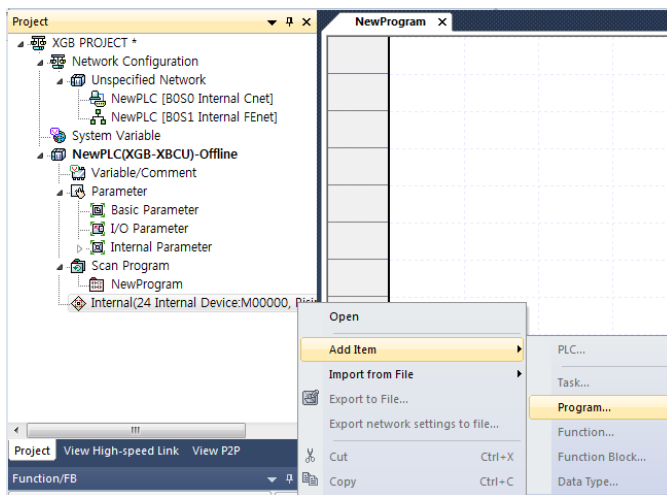

(d) Register the task program name and comment.

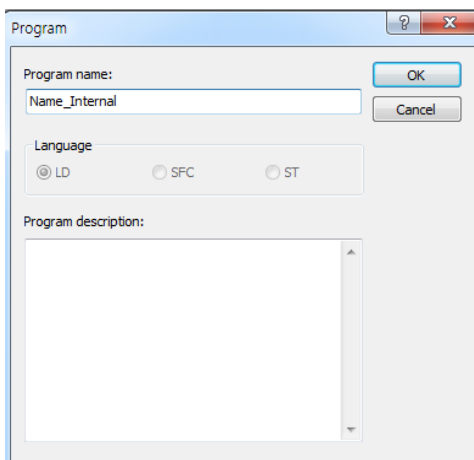

(e) If the program window for writing the task program is displayed, you can make the task program here.

(2) Instructions to use the internal device task

The internal contact task detects the startup conditions of the internal device set by the scan END and runs the relevant internal device task program. Keep the below instructions in mind.

- The internal device task program runs when the scan program is completed. Accordingly, although the execution conditions of the internal device task program occur in the scan programs or task programs (fixed cycle, external contact, high speed counter), it will run at the time of completing the scan program instead of running immediately.
- In the case of the internal device task, the execution conditions are searched when the scan program is completed. Accordingly, if the execution conditions of the internal device task occur and dissipate by the scan program or other task programs, the task will not run since the execution conditions cannot be detected at the time of searching the conditions.

### 1.1.10 High speed counter task

(1) How to set up the task

- (a) Adding tasks: Select 『Project』 – 『Add Items』 – 『Task』 or after clicking with the right mouse button on the project name of the project tree, select 『Add Items』 - 『Task』 as shown in the below figure.

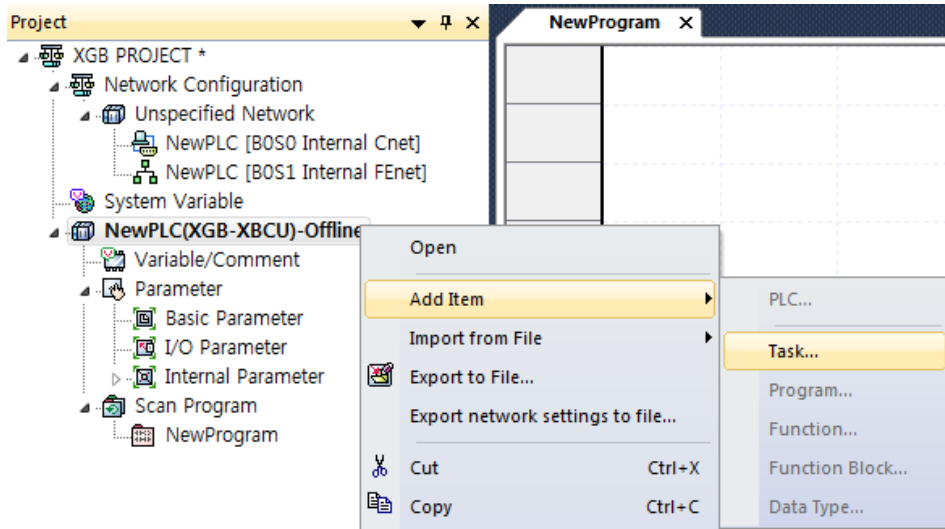

- (b) The screen for registering the task will be displayed. Click 『High speed counter』 in the execution conditions and after entering the task name, select the channel.

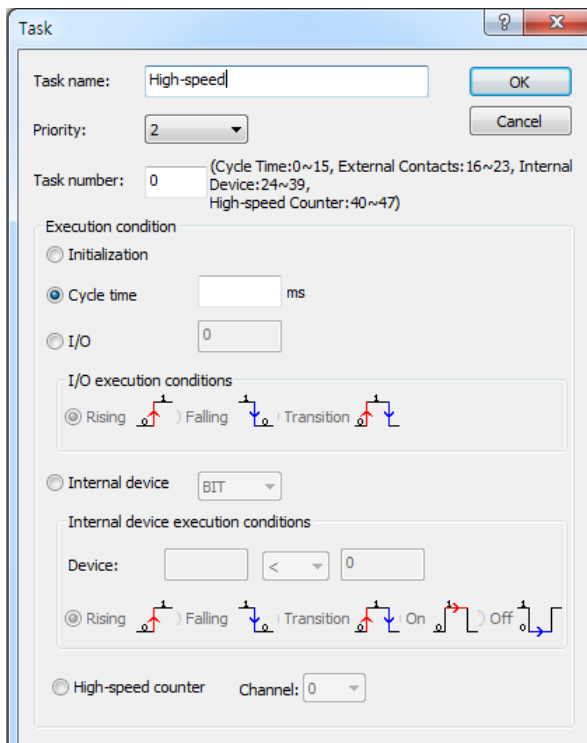

(c) Click on the right mouse button on the registered task and click 『Add Items』 - 『Program』 .

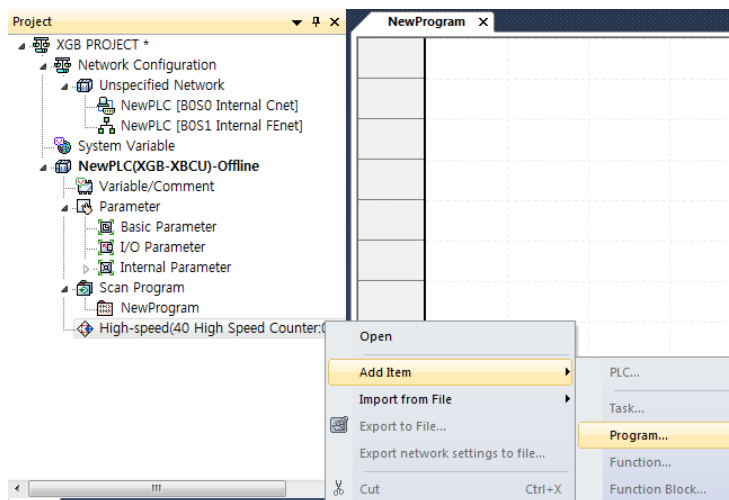

(d) Register the task program name and comment.

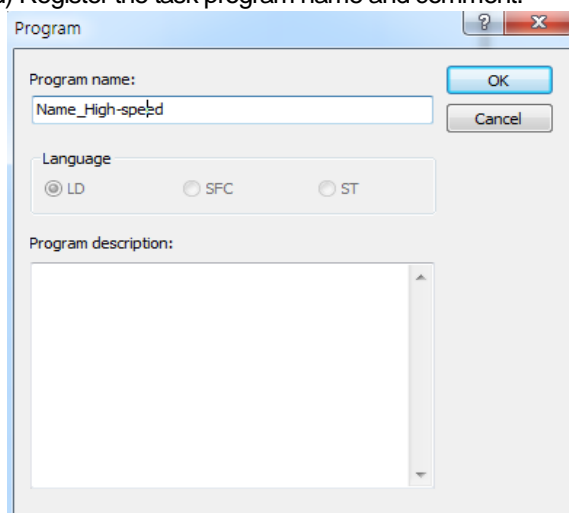

(e) If the program window for writing the task program is displayed, you can make the task program here.

(2) Instructions to use the high speed counter task

- When the high speed counter's current value in the selected channel becomes equal to the comparative output set value of 0 of the relevant channel in the below Fig., the high speed counter task will be detected and the task program will run.
- You can check whether the conditions of the high speed counter task occur at every 250us cycle so detection delay may occur up to 250us.
- The operations of the high speed counter task are performed only when the operation mode is RUN mode.

## 1.2 Operation mode

The high performance XGB PLC has 3 operation modes; RUN mode, STOP mode, DEBUG mode. This section describes the execution processing of each operation mode.

### 1.2.1 RUN mode

It is the mode executing the program normally.

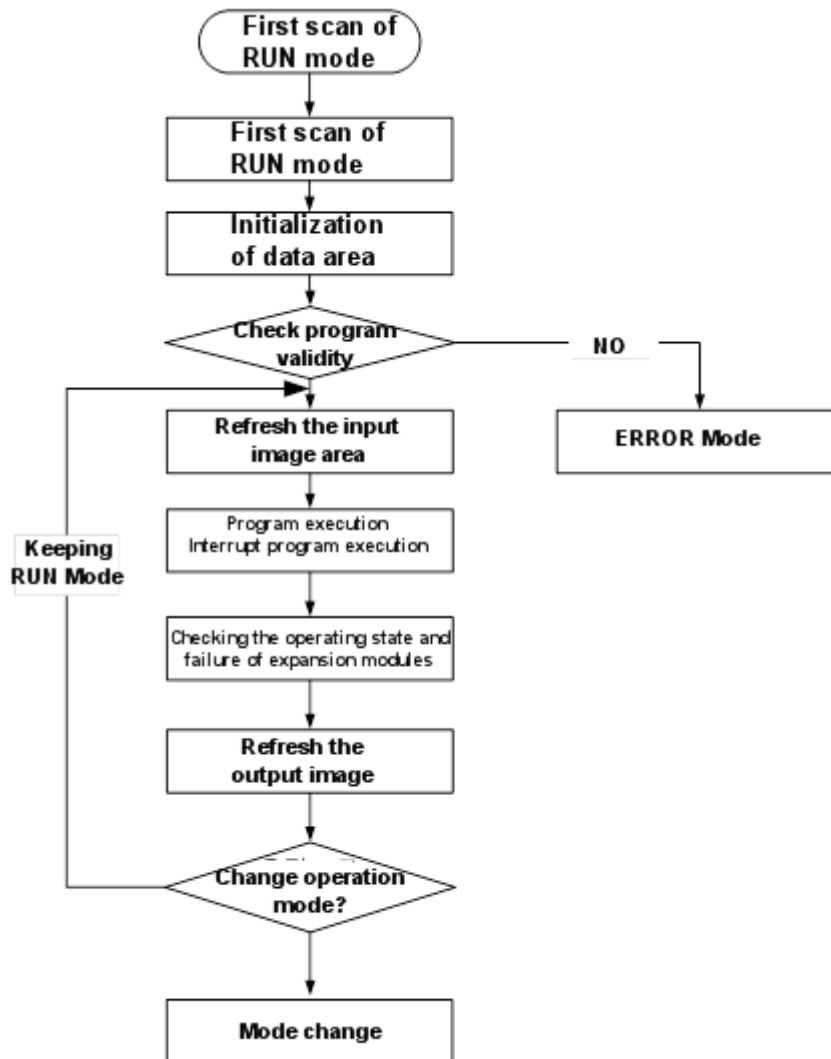

(1) When changing the mode from other into RUN

Initialize the data area at the beginning stage and check the validity of the program to determine whether it can be executed or not.

(2) Execution processing details

I/O Refresh and program operation are executed.

(a) The interrupt program is executed by detecting the startup conditions of the interrupt program.

(b) Normal operation or fail of the equipped module is checked.

- (c) Communication services are executed with other internal processing.

### 1.2.2 STOP Mode

It is the mode of block state without operations of the program. In STOP mode, you can write the programs and parameters through XG5000.

- (1) When changing the mode from other into STOP
  - Eliminate the output image area and execute Output Refresh.
- (2) Execution processing details
  - (a) I/O Refresh is executed.
  - (b) Normal operation or fail of the equipped module is checked.
  - (c) Communication services are executed with other internal processing.

### 1.2.3 DEBUG Mode

It is the mode to find errors of the program or track the operation processes. You can convert the mode into Debug in STOP mode only. Though this mode, you can verify the program by checking the execution status of the program and details of each data.

- (1) When changing the mode from other into DEBUG
  - (a) Initialize the data area at the beginning stage of changing the mode.
  - (b) Eliminate the output image area and execute Input Refresh.
- (2) Execution processing details
  - (a) I/O Refresh is executed.
  - (b) The debug operations will be executed based on the setting status.
  - (c) Output Refresh is executed after debugging until the end of the program.
  - (d) Normal operation or fail of the equipped module is checked.
  - (e) Other services such as communication, etc. are executed.

## 1.2.4 Change of operation modes

### (1) How to change operation modes

You can change the operation mode with the below methods.

- (a) Change by the mode key of the basic unit
- (b) Change by connecting the programming tool (XG5000) to the PLC
- (c) Changing the operation mode of the other basic unit connected to network with XG5000 accessed to the basic unit 1 (remote access)
- (d) Change by using XG5000, HMI, communication module connected to the network
- (e) Change by the 'STOP' command during execution of the program

### (2) Kinds of operation modes

The following operation modes are set by the mode setting key of the basic unit and XG5000's commands.

Operation mode switch	XG5000 command	Operation mode	Remarks
RUN	Unchangeable	Local RUN	When the operation mode switch is located in RUN position, the mode change by XG5000 is impossible.
STOP	RUN	remote RUN	
	STOP	remote STOP	
	Debug	Debug	
RUN → STOP	-	STOP	

(a) The mode change by XG5000 is available only when the operation mode switch is in **STOP** state.

(b) If you want to change the mode into 'STOP' with a switch in the remote RUN state by XG5000, operate the switch as STOP → RUN → **STOP**.



## 1.3 Memory

### 1.3.1 Data memory

#### (1) Bit device area

Various bit devices are provided by function. In terms of designation method, the first digit indicates the device type; the middle digit indicates the decimal word position; the last digit indicates the hexadecimal bit position in word.

Displaying areas by device	Characteristics of devices	Purpose
P0000~P1023F	I/O contact	It is the image area saving the state of I/O contacts. The device reads the input module state and saves it to the P area. The P area data saving operation results is saved to the output module.
M0000~M1023F	Internal contact	It is the internal memory to save bit or word data in the program.
L0000~L4095F	Communication contact	The device displays the state information of high speed link/P2P service in the communication module.
K00000~K4095F	Contacts against blackout for embedded special functions	It is the device area maintaining the data during blackout. It can be used without setting the parameters against blackout separately. (Among K areas, some areas are used by the embedded high speed counter, data log, PID function. If 'Write' is executed in the relevant area, the embedded function will not work normally so be careful about this.
F0000~F1023F	Special contacts	It is the system flag area managing the flags required to operate the system in the PLC.
T0000~T1023	Timer contacts	It is the area saving the state of the timer contacts/current values/set values.
C0000~C1023	Counter contacts	It is the area saving the state of the counter contacts/current values/set values.
S00.00~S127.99	Step controller 128 x 100 Step	It is the relay for step control.

#### (2) Word device area

Displaying areas by device	Characteristics of devices	Purpose
D0000~D10239	Data register	It is the area keeping the internal data. It also can be expressed as bit. (Ex.: No.0 bit of D0000.0→ D0)
U00.00~U08.31	Analog data register	It is the register used to read the data from the special module equipped to the slot. (It can be expressed as bit)
N0000~N10239	Communication data register	Area saving the P2P service of the communication module. (It cannot be expressed as bit)
Z000~Z127	Index register	Dedicated device to use index functions (It cannot be expressed as bit)
T0000~T1023	Timer's current value register	Area indicating the timer's current value.
C0000~C1023	Counter's current value register	Area indicating the counter's current value.

## 1.3.2 Memory block diagram

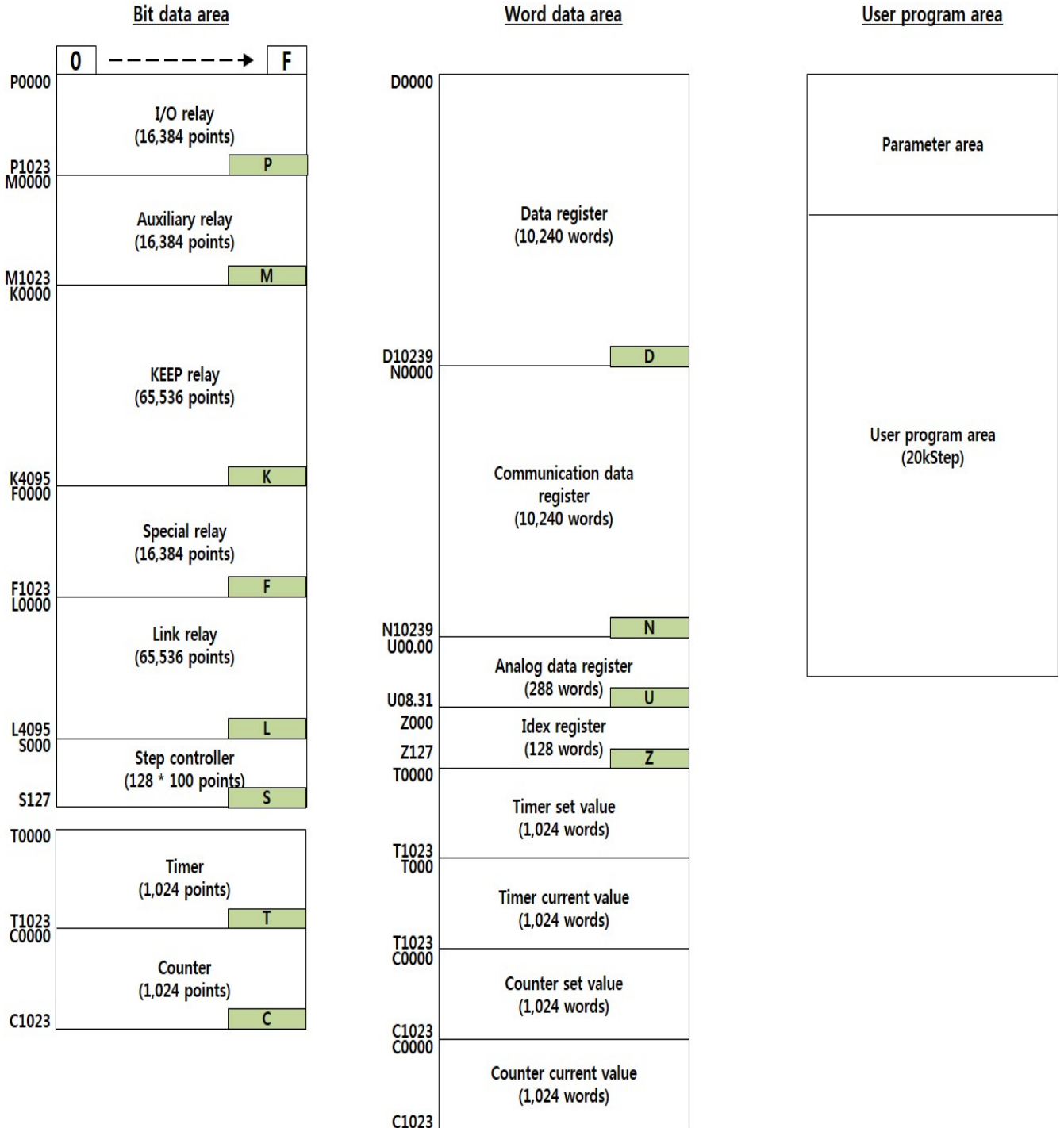

### 1.3.3 Setup of the data latch area

If you want to keep and use the data required for operations or data generated during operations even when the PLC restarts after the stoppage, 'data latch' can be applied. You can use the certain areas of some data devices as the latch areas by setting parameters.

•You can set up the latch range for the below devices by parameters.

Device	Latch area 1	Latch area 2	Characteristics
P	X	X	Image area saving the I/O contacts state
M	O	O	Internal contact area
K	X	X	Contacts that keep the contact state during blackout.
F	X	X	System flag area
T	O	O	Area related to the timer (For both bit/word)
C	O	O	Area related to the counter (For both bit/word)
S	O	O	Relay for step control
D	O	O	Area saving general word data
U	X	X	Analog data register (Not latched)
L	X	X	High speed link/P2P service state contacts of the communication module (Not latched)
N	X	X	Communication module's P2P service address area (latched)
Z	X	X	Register for index only (Not latched)
R	X	X	File register (latched)

#### Notice

- K, N, R devices can be basically latched without setting parameters.
- P, U, Z devices cannot be latched.

(1) How to set up the latch area

(a) After clicking the 'Device Area Setup' of the basic parameter, select the latch to be used and input the initial address and end address.

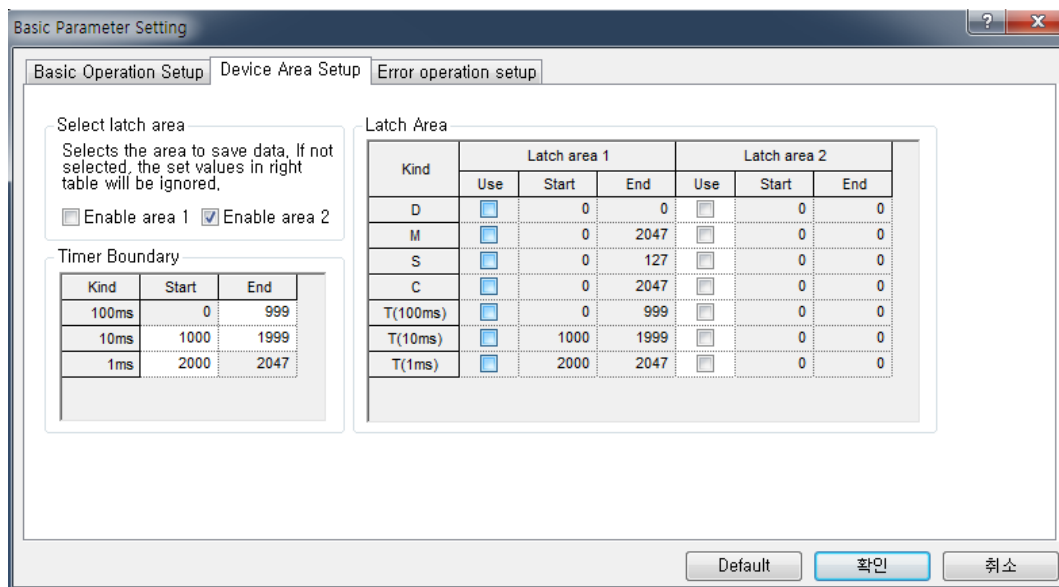

## Chapter 1 Program Configuration and Operation Method

### (2) Operation of the data latch area

(a) The device set as the latch area keeps the previous data without initialization when the power is recovered after cutting the power supply of the PLC.

(b) You can delete the latched data in the following ways.

- Deleting latch1, latch 2 with XG5000
- Writing with the program (The initialization program is recommended)
- Inputting 0 in the window of XG5000 monitor

Refer to the below table for Maintaining or Reset (clear) operation of the latch area data depending on the PLC operations.

No.	Operations	Detailed operations	latch1	latch2	Remarks
1	Power On/Off	On / Off	Maintain	Maintain	
2	Reset by XG5000	Overall Reset	Reset	Maintain	
3	Write program (online)	-	Maintain	Maintain	
4	Broken backup data	Broken SRAM due to (breakdown of a battery, etc.)	Reset	Reset	
		Broken data due to other reasons	Reset	Reset	
5	XG5000 online	Latch 1 Clear	Reset	Maintain	
		Latch 2 Clear	Reset	Reset	

(c) If you click 『Online』 - 『Reset/Clear』 - 『Reset PLC』 - 『Overall Reset』, the latch 1 area will be cleared.

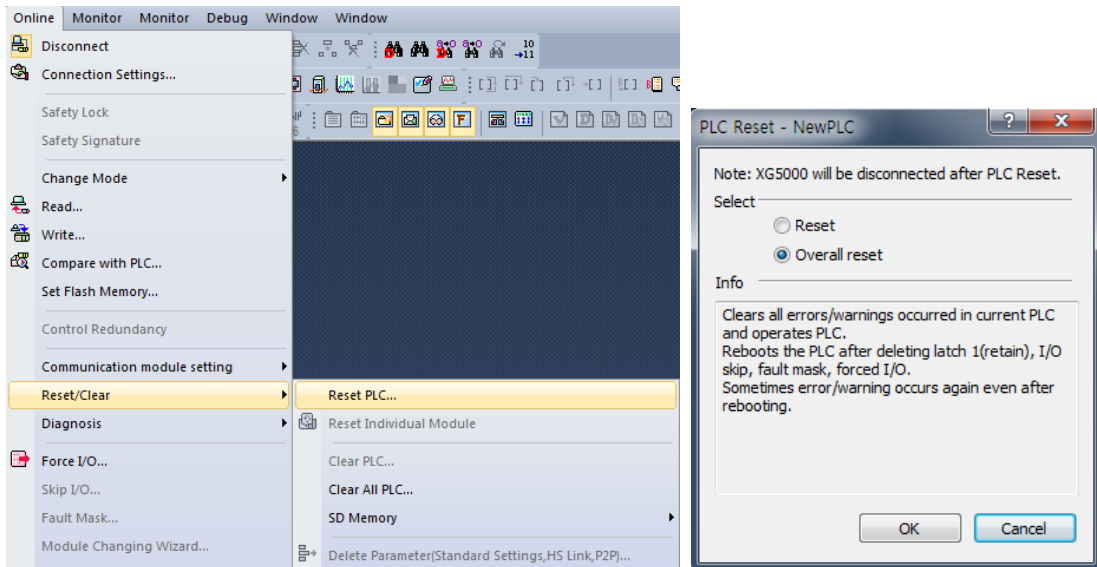

(d) After selecting 『Online』 - 『Reset/Clear』 - 『Clear PLC』 latch area 1,2, if you click “Delete”, it will be cleared.

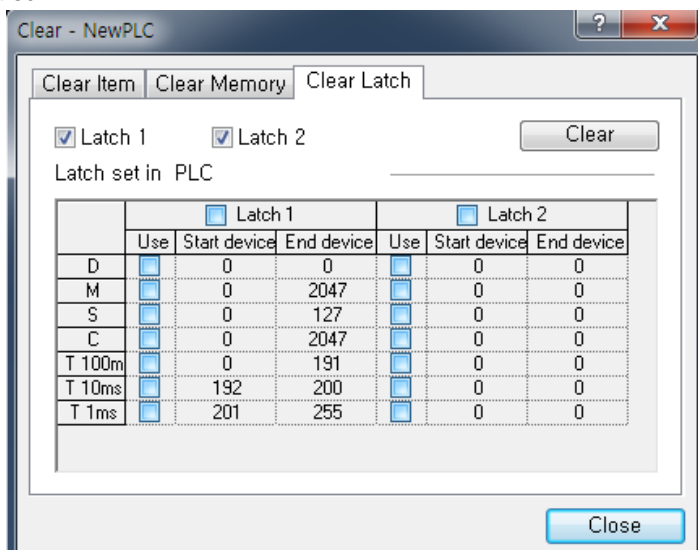

(3) Deletion of data at once

If you click 'Delete' in the memory area, the memory of all devices will be deleted as '0'. So this function can be used when you want to delete the certain area of the device at once.

(a) After selecting 『Online』 - 『Reset/Clear』 - 『Clear PLC』 - 『Clear Memory』, if you set up the area to be deleted and click “Delete”, the device area will be cleared.

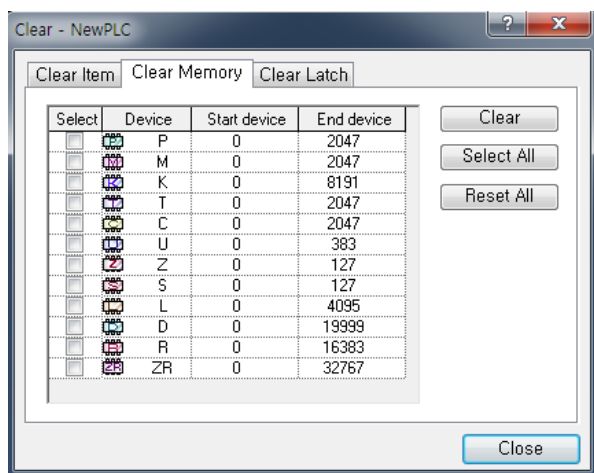

#### Notice

- In case the mode is changed into RUN by a switch in the remote RUN mode, the PLC is operates continuously without intermission.
- Modification is possible during run in the RUN mode by a switch but the mode change operations through XG5000 are restricted. Only when mode change is not allowable in a remote site, set the mode switch in RUN position.

## Chapter 2 CPU Function

### 2.1 Type Setting

This section describes setting XGB PLC models.

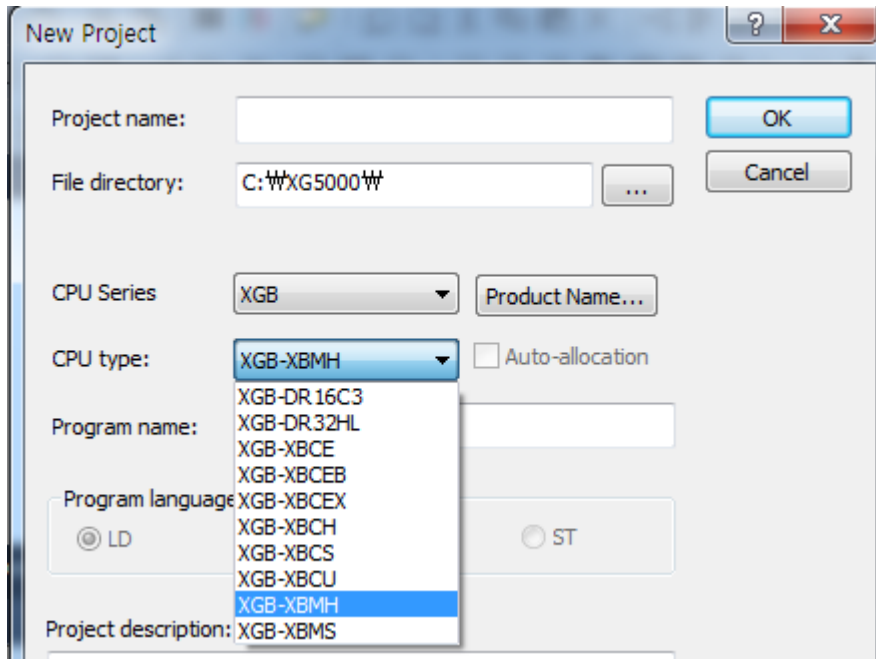

PLC Name	CPU Type	Language	Description	Remarks
XGB	XGB-DR16C3	MK language	Dedicated product	Modular type
	XGB-DR32HL	MK language	Dedicated product	Compact type
	XGB-XBCE	MK language	Economic : XBC-DR10/14/20/30E XBC-DN10/14/20/30E, XBC-DP10/14/20/30E	Compact type
	XGB-XBCH	MK language	Deluxe: XBC-DR32/64H, XBC-DN32/64H XBC-DP32/64H	Compact type (DC power PLC included)
	XGB-XBCS	MK language	Standard : XBC-DR20/30/40/60SU, XBC-DN20/30S (U), XBC-DN40/60SU	Compact type
	XGB-XBMS	MK language	Standard : XBM-DN16/32S , XBM-DR16S	Modular type
	XGB-XBMH	MK language	Standard : XBM-DN32S	Modular type
	XGB-XBCU	MK language	high performance : XBC-DN32U, XBC-DN32UP, XBC-DN32UA XBC-DP32U, XBC-DP32UP, XBC-DP32UA XBC-DR28U, XBC-DR28UP, XBC-DR28UA	Compact type (DC power PLC included)

## 2.2 Parameter Setting

This section describes XGB PLC's parameter setting.

### 2.2.1 Basic parameter setting

If you click the basic parameter in the project window, the below screen will be displayed.

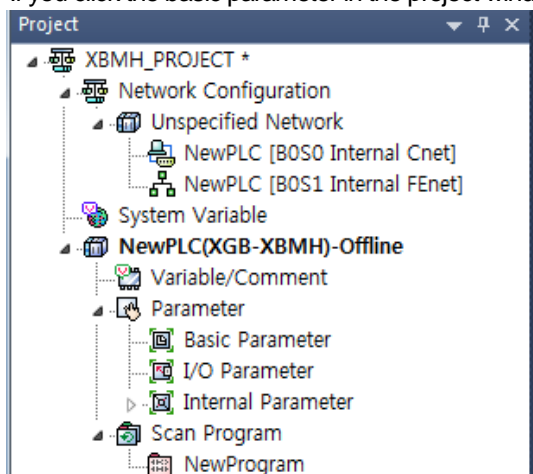

You can set up 3 items; 'Basic operation setting', 'Device area setting', 'Error operation setting'.

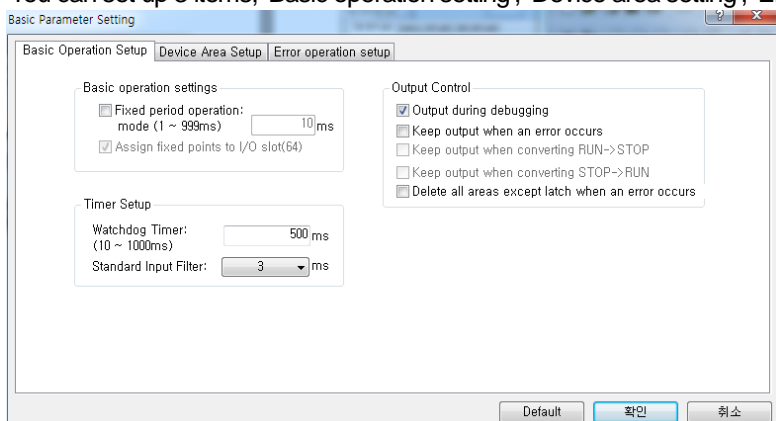

Classification	Items	Descriptions	Set values
Basic operations	Fixed cycle operation	Set the fixed cycle operation time.	1~999ms
	Watchdog timer	Set the scan Watch Dog's time.	10~1000ms
	Standard input filter	Set the standard input filter's time.	1,3,5,10,20,70,100ms
	Output during debugging	Set whether allowing the actual output during debug operation.	Allowable/Prohibited
	Output Hold when errors occur	Determine whether allowing the Output Hold function set in I/O parameters when errors occur	Allowable/Prohibited
Device area setting	Selection of latch area	Set each device's latch area.	
Error operation	Resumption of operation in case of computational errors.	Determine whether stopping or resuming the operation in case of computational errors.	Stop/Resume

### 2.2.2 I/O parameters Setting

It is the function to set up and reserve the information for each I/O. If you click 『I/O Parameter』 in the project window, the below setting window will be displayed.

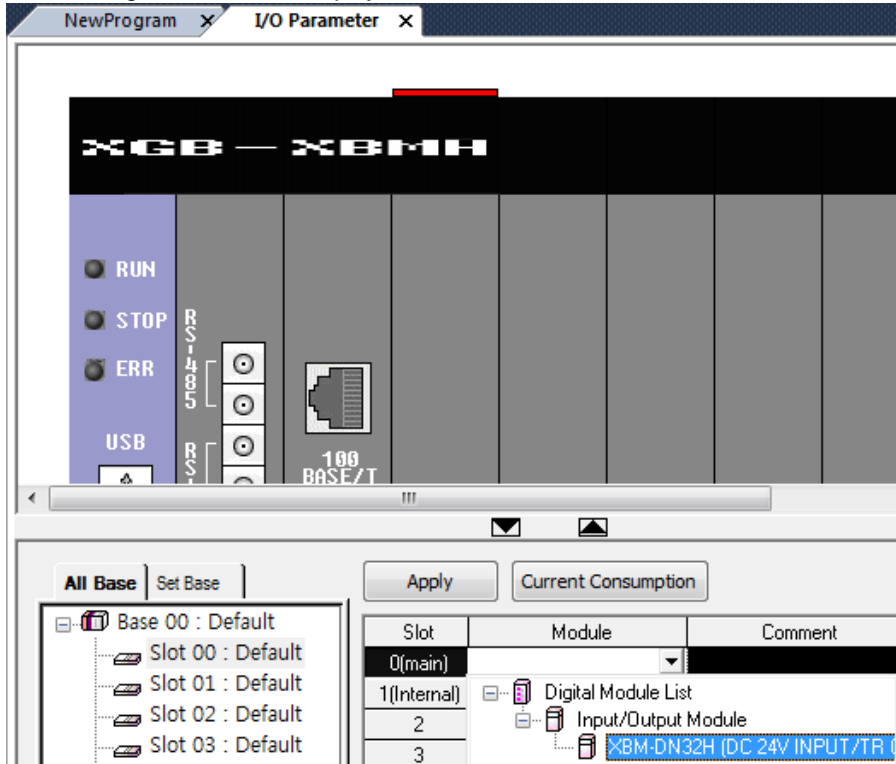

If you click the 『Module』 in the 『slot』 position, the list of each module will be displayed. Then, choose the module that is matched with the actual system to be configured. The selected slot will be displayed as below.

Slot	Module	Comment	Input Filter	Emergency Out	Allocation
0(main)	XBM-DN32H (DC 24V)		3 Standard[ms]	Default	P0000 ~ P003F
1(Internal)					
2					
3					
4					
5					



If you press 『In Detail』 button on the slot image or the relevant slot position in the base window as below, the window for setting the filter, emergency output will be displayed.

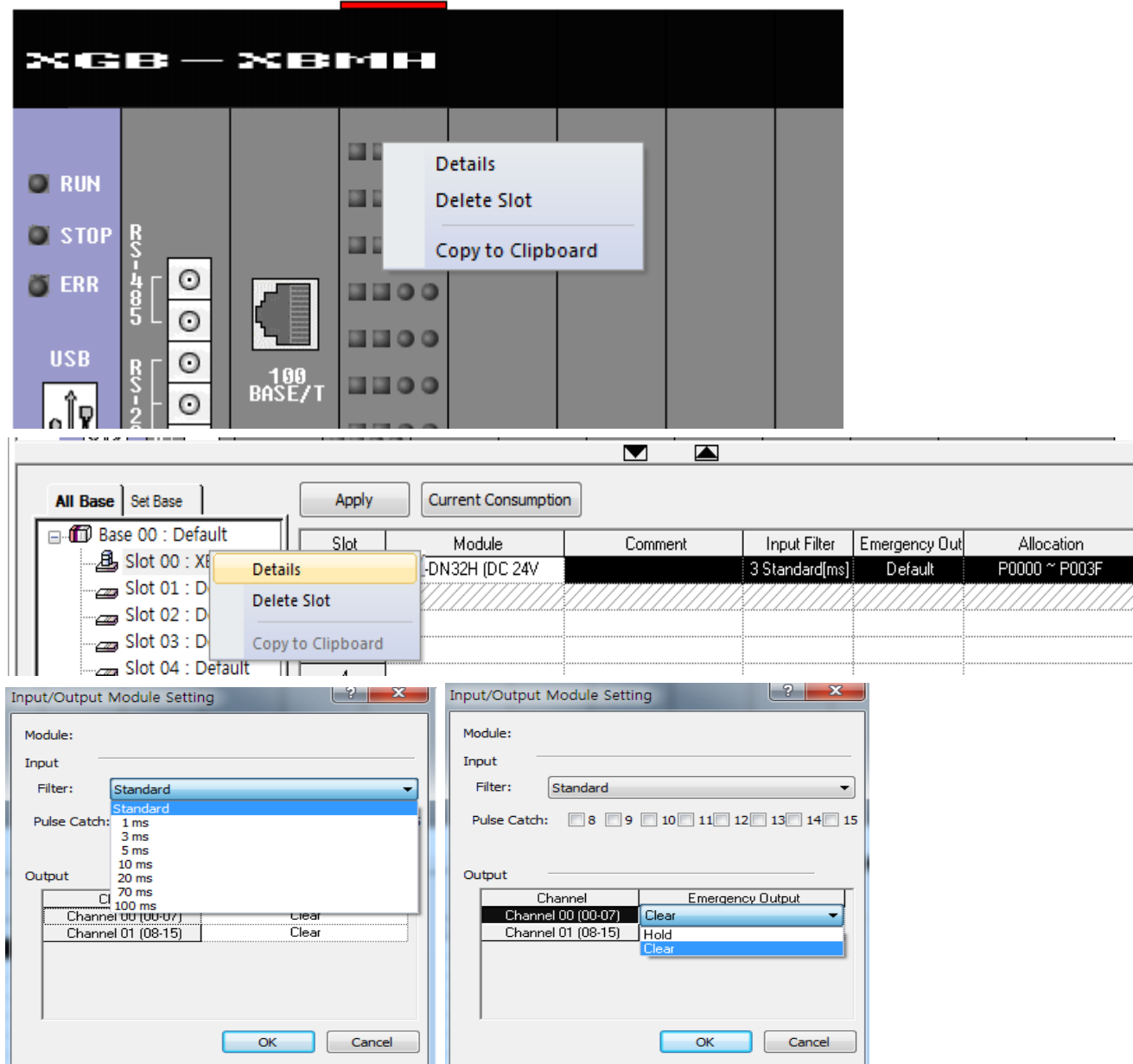

#### Notice

- In case each set details are different from the actually accessed I/O module, 'Module Type Mismatch Error' occur and the error will be displayed.
- If there is no setting, the CPU reads each I/O module's information for operation.

## 2.3 Self-Diagnosis Function

The Self-Diagnosis function is the function for the CPU part to diagnose the PLC system for defects. In case errors occur during supplying the power to the PLC system or during operation, it detects errors to prevent malfunction of the system and preventive maintenance.

### 2.3.1 Scan Watchdog timer (Scan Watchdog Timer)

The WDT (Watchdog Timer) is the function to detect the congestion of programs caused by PLC module's hardware or software.

- (1) The Watchdog timer is the timer to be used to detect operation delay caused by the user program error. You can set up the Watchdog timer's detection time in XG5000's basic parameters as below (Initial value: 500ms).

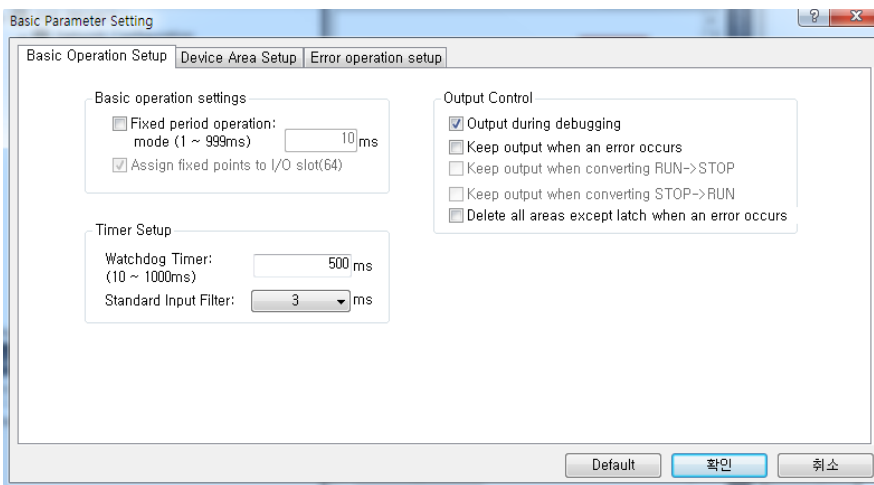

- (2) The Watchdog timer monitors the scanning time during operation and when set detection time is exceeded, it stops the PLC's operations immediately. At this time, the output status is maintained or cleared based on the details of 'Output Hold when errors occur'.
- (3) If it is expected that the Scan Watchdog Time is exceeded since it takes more time to process the specific part of the user programs (in case of using FOR ~ NEXT command, CALL command, etc.), clear the Watchdog timer through the 'WDT' command.

The 'WDT' command initializes the scan Watchdog time and restarts measuring time from 0.

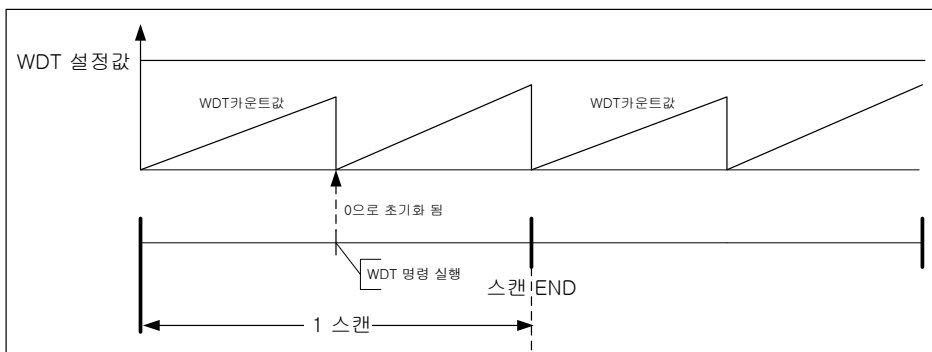

(Example of initializing scan Watchdog timer through the WDT command)

- (4) In case the Watchdog error occurs, you can clear the error by resupplying the power or converting the mode into STOP.

### 2.3.2 Function to save error history

When errors occur, the high performance XGB basic unit records the error history to clean up causes easily. If you click 『Online』 - 『Error/Warning』, you can see the current errors and the history. Remove the causes of errors referring to the details and corrective measures of each error item.

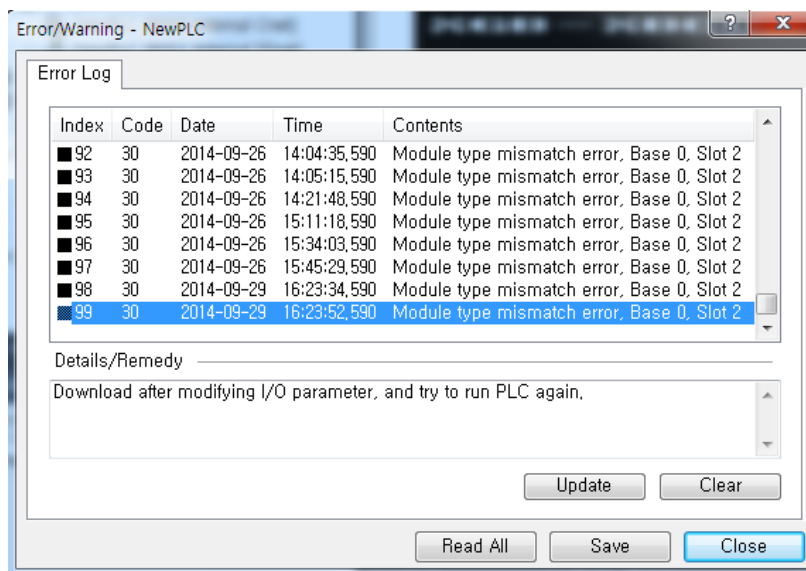

Items	Description	Remarks
Error/Warning	Displays the current Error/Warning.	-
Error history	Displays Error/Warning occurred in order of time.	Saving up to 100

#### Notice

If you click 'Delete' in the Error/Warning window, all the saved error history will be deleted.  
In case the error histories exceed 100EA, the histories are deleted in order from the one that occurred first and the 100EA recent histories are saved

### 2.3.3 Failure Management

#### (1) Failure Types

The troubles are caused by failure of the PLC itself, system configuration's error, error detection of operational results, etc. They can be divided into the failure mode stopping the operation for system safety; minor failure mode that informs a user of failure warning and resumes the operation.

The failures of the PLC system are mainly caused by the below.

- PLC hardware's problems
- System configuration's error
- Operational error during execution of user programs
- Detection of errors caused by external device failure

#### (2) Operation mode in case of failures

In case failures occur, the PLC system records the failure details in the special flag (F area) and determines whether resuming the operation based on the failure mode.

- In case of the PLC hardware's failure  
In case there are problems with the CPU, power, etc. that the PLC cannot work normally, the system will

be stopped; In case of minor failures such as a battery's low voltage, the warning is displayed and the operation will be resumed.

- In case of system configuration's error

It is the failure occurred when the actual PLC's module configuration is not matched with the module configuration set in XG5000. The system will be stopped.

- Computational error during execution of user programs

In case of the numeric operation error (Ex.: in case the denominator of division operation is 0) occurred during execution of user programs, the details will be displayed in the error flag and the system will resume the operation. If the operational time exceeds the operation delay monitoring set time during operation or equipped I/O modules cannot be normally controlled, the system will be stopped.

#### Notice

- When operational errors occur during executing programs, you can determine whether resuming the operation based on the settings of "Basic parameter -> Error operations setting -> Resume the operation in case of operational errors" of the XG5000 project.
- This parameter's default value is set as "Resume the operation in case of operational errors".

- Detection of errors caused by external device failure

The failure of the external control device can be detected by the PLC's user program; in case of detecting failures, the system will be stopped; in case of detecting minor failures, only the detection status will be displayed and the operation will be continued. (For the detailed use of the function to detect external device's failures, refer to the 2.3.6 Failure Diagnosis Function for the External Device.)

The information on failures occurrence is saved in the special relay (F area). Among F area flags, the information related to the failures are as below.

Word	Bit	Flag Name	Function	Description
F000	F0002	_ERROR	ERROR	ERROR status
F002~3	-	_CNF_ER	System error	Reports the failure status of the system.
	F0021	_IO_TYER	Module type error	The module type is not matched.
	F0022	_IO_DEER	Module separation error	The module is separated.
	F0024	_IO_RWER	Module I/O error	There are some problems with the module I/O.
	F0025	_IP_IFER	Module interface error	There are some problems with the special / communication module interface.
	F0026	_ANNUM_ER	External device failure	Failures are detected from the external device.
	F0028	_BPRM_ER	Basic parameters	There are some problems with the basic parameters.
	F0029	_IOPRM_ER	IO parameters	There are some problems with I/O parameters.
	F002A	_SPPRM_ER	Special module parameters	Abnormal special module parameters
	F002B	_CPPRM_ER	Communication module parameters	Abnormal communication module parameters
	F002C	_PGM_ER	Program error	There are some errors with the program.
	F002D	_CODE_ER	Code error	There are some errors with the program code.
	F002E	_SWDT_ER	System Watch dog	The system Watchdog works.
F0030	_WDT_ER	Scan Watch dog	The scan Watchdog works.	

Word	Bit	Flag Name	Function	Description
F004		_CNF_WAR	System warning	Reports the minor failure status of the system.
	F0041	_DBCK_ER	Backup error	There are some problems with data backup.
	F0043	_ABSD_ER	Shutdown caused by abnormal operation	Stoppage caused by abnormal operation.
	F0046	_ANNUM_WAR	External device failure	Minor failures are detected from the external device.
	F0048	_HS_WAR1	High speed link1	High speed link – more than parameter1
	F0049	_HS_WAR2	High speed link2	High speed link – more than parameter2
	F0054	_P2P_WAR1	P2P parameter1	P2P – more than parameter1
	F0055	_P2P_WAR2	P2P parameter2	P2P – more than parameter2
	F0056	_P2P_WAR3	P2P parameter3	P2P – more than parameter3
		_CONSTANT_ER	Fixed cycle error	Fixed cycle error
F011		_LOGIC_RESULT	Logic result	Displays the logic result.
	F0110	_LER	Operational error	It Is On during 1 scan in case of operational error.
	F0111	_ZERO	Zero flag	It is On when the operational result is 0.
	F0112	_CARRY	CARRY flag	It is On when CARRY occurs during operation.
	F0113	_ALL_Off	All outputs Off	It is On when all outputs are Off.
		_LER_LATCH	Operational error latch	It maintains 0 in case of operational error.
F015	-	_PUTGET_ERR0	PUT/GET error 0	main base PUT / GET error
F023	-	_PUTGET_NDR0	PUT/GET completion 0	main base PUT / GET completion
F058	-	_ERR_STEP	Error step	Saves error step.
F060	-	_REF_COUNT	Refresh	Increases when executing module REFRESH
F062	-	_REF_OK_CNT	Refresh OK	Increases when module REFRESH is normal.
F064	-	_REF_NG_CNT	Refresh NG	Increases when module REFRESH is abnormal.
F066	-	_REF_LIM_CNT	Refresh Limit	Increases when module REFRESH is abnormal. (TIME OUT)
F068	-	_REF_ERR_CNT	Refresh Error	Increases when module REFRESH is abnormal.
F090	-	_IO_TYER_N	Mismatch slot	Displays the slot number with the mismatch module type.
F091	-	_IO_DEER_N	Slot with separated module	Displays the slot number with the separated module.
F093	-	_IO_RWER_N	RW error slot	Displays the slot number with module Read/Write error
F094	-	_IP_IFER_N	IF error slot	Displays the slot number with module interface error
F096	-	_IO_TYER0	Module type 0 error	Main base's module type error
F104	-	_IO_DEER0	Module separation 0 error	Main base's module separation error
F120	-	_IO_RWER0	Module RW 0 error	Main base's module Read/Write error
F128	-	_IO_IFER_0	Module IF 0 error	Main base's module interface error
F202	-	_ANC_ERR	Information on the external device's failure	Displays the information on the external device's failure
F203	-	_ANC_WAR	Information on the external device's minor failure	Displays the information on the external device's minor failure

## Notice

- For more details on the whole flags, refer to the Appendix 1 Flag Table of the Outline of this manual.

### 2.3.4 Function to check the battery voltage

It is the function to detect and inform the fact that the battery voltage is lower than the memory backup voltage. When a battery low voltage, the ERR LED of the voltage unit is flickering at 1 second interval and F0045 (\_BAT\_ER)flag is On. In this case, you need to change the battery referring to 3.4.4 How to change a battery of the Outline of this manual.

### 2.3.5 Function to check the expansion module

It is the function to check whether I/O modules work normally during startup and operation. It checks the status of every scan expansion module and the PLC checks whether the following situations occur.

- In case the module that is different from the set parameter is installed at the time of initial operation or failure is suspected
- In case expansion modules are detached or failure is suspected.

If abnormal conditions are detected, the basic unit's ERR LED will be flickering and the PLC will be stopped.

### 2.3.6 Failure Diagnosis Function for the External Device

It is the function to detect the failure of the external device connected to the PLC to realize stoppage of the system and warning easily. Through this function, you can detect the external device's failure without complex programming and can monitor the failure position without special devices (XG5000, etc.) or programs.

You can use the failure diagnosis function for the external devices as below.

(1) Failure types of external devices

- The failures of external devices are divided into the two types; failure (error) detected by combination of user programs and special relay (F area) requires stoppage of the PLC operation; minor failure (warning) that continues the PLC's operation and displays the detection status only.

(2) Flag to detect failures of external devices

The following flag types are used to diagnose failures of external devices.

Word	Bit	Flag Name	Function	Description
F0202	-	_ANC_ERR	Information on the external device's failures	Input the error code of user-defined serious failure of external device.
F0203	-	_ANC_WAR	Information on the external device's MINOR failures	Input the error code of user-defined minor failure of external device.
-	F0026	_ANNUM_ER	detection of external serious error	It is On when the external device's serious failure occurs.
-	F0046	_ANNUM_WAR	detection of external slight error	It is On when the external device's minor failure occurs.
-	F2002	_CHK_ANC_ERR	Request detection of external serious error	It is the command flag asking to detect the external device's serious failure.
-	F2003	_CHK_ANC_WAR	Request detection of external slight error minor failure	It is the command flag asking to detect the external device's minor failure.

## (3) How to detect the external device's serious failures

The following programming is used to detect the external device's serious failures.

- Save the error code that can be distinguished by external device's serious failures in F202 (\_ANC\_ERR) through the FWRITE command as below. (Input the values excluding 0)
- In case the external device's serious failures occur, F2002 (\_CHK\_ANCE) flag will be On.
- When the scan program is completed, the PLC checks whether F2002 (\_CHK\_ANCE) is ON and detects serious failures.
- If the external device's serious failures occur, the PLC will be in error status and will stop the operation. Then, F0026 (\_ANNUM\_ER) is ON and F2002 flag is automatically Off. All outputs works based on IO parameter's emergency output settings.
- When failures occur, through XG5000, a user can figure out the causes of failures by monitoring F202 (\_ANC\_ERR) flag.
- The below figure describes the example of the program detecting the external device's serious failures with operation details.

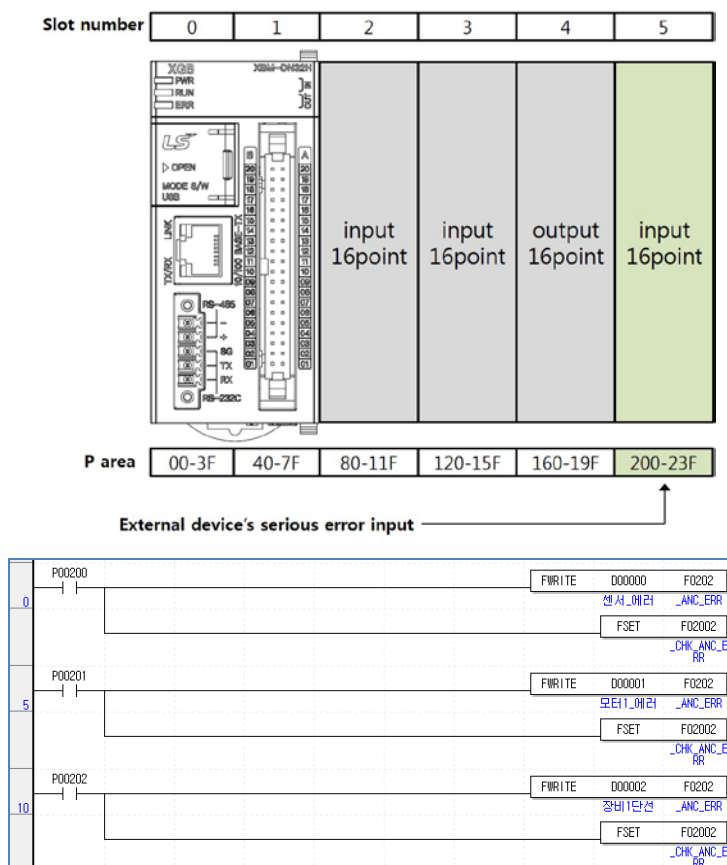

<Example of the system configuration and program >

- In this example, assume that the input signal to detect the external device's failures is connected to the input module of No.5 slot in the system configuration as below.
  - In case of the sensor failure, P200 is ON. The error code is the value saved in D0000.
  - In case of the motor failure, P201 is ON. The error code is the value saved in D0001.
  - When the device 1 is disconnected, P202 is ON. The error code is the value saved in D0002.
- In the above programming, when P20 is On (In case of sensor failure), the value of D000 is saved in F202 (\_ANC\_ERR) and F2002 (\_CHK\_ANCE) will be On.

## Chapter 2 CPU Function

- If F2002 is ON, it is detected by the scan end and the external device's serious failures are generated.
- You can detect the failure of motor 1, disconnection of device 1 in the same way.
- After accessing to XG5000, a user can check which external devices have failures by verifying the F202 value and can take follow-up measures.

#### (4) How to detect the external device's minor failures

The following programming is used to detect the external device's minor failures.

- Save the warning code that can be distinguished by external device's minor failures in F203\_ANC\_WAR through the FWRITE command as below. (Input the values excluding 0)
- In case the external device's minor failures occur, F2003 (\_CHK\_ANC\_WAR) flag will be On.
- When the scan program is completed, the PLC checks whether F2003 (\_CHK\_ANC\_WAR) is ON and detects minor failures.
- If the external device's minor failures occur, the ERR LED will be flickering at 2 seconds interval and the PLC will run continuously. Then, F0046 (\_ANNUM\_WAR) is ON and F2003 flag is automatically Off. All outputs works based on IO parameter's emergency output settings.
- When minor failures occur, through XG5000, a user can figure out the causes of failures by monitoring F203 (\_ANC\_WAR) flag.
- If you input 0 again to F203 (\_ANC\_WAR) after removing the causes of failures and turn ON F2003 (\_CHK\_ANC\_WAR) again, detection of minor failures is canceled.
- The below figure describes the example of the program detecting the external device's minor failures with operation details.

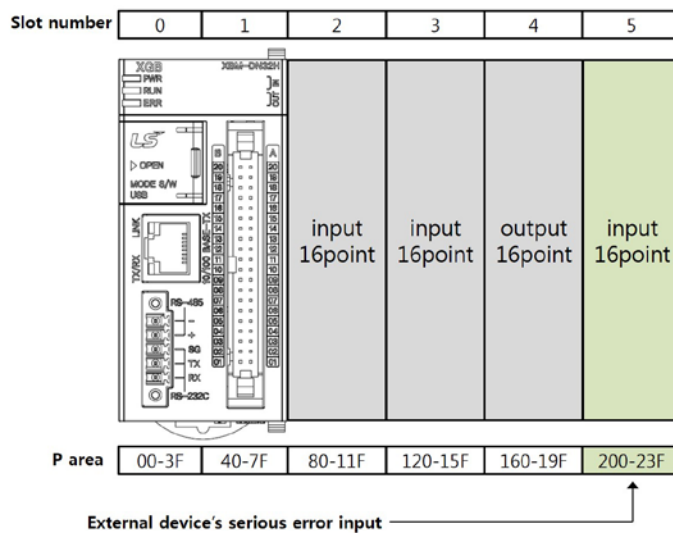



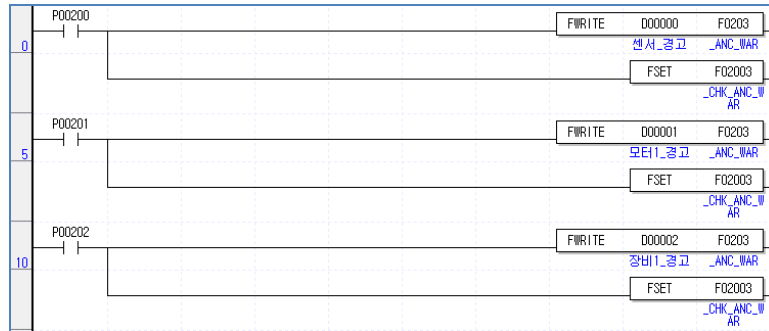

< Example of the system configuration and program >

- In this example, assume that the input signal to detect the external device's minor failures is connected to the input module of No.5 slot in the system configuration as below.
  - In case of the sensor warning, P200 is ON. The warning code is the value saved in D0000.
  - In case of the motor warning, P201 is ON. The warning code is the value saved in D0001.
  - When the device 1 is warned, P202 is ON. The warning code is the value saved in D0002.
- In the above programming, when P20 is On (in case of sensor failure), the value of D000 is saved in F203 (\_ANC\_WAR) and F2003 (\_CHK\_ANC\_WAR) will be On.
- If F2003 is ON, it is detected by the scan end and the external device's serious failures are generated.
- You can detect the warnings on motor 1 and device 1 in the same way.
- After accessing to XG5000, a user can check which external devices have minor failures by verifying the F203 value and can take follow-up measures.

## 2.4 RTC Function

XBM H' unit has the clock (RTC) function and the clock keeps working thanks to the battery backup even when the power is Off. You can use the embedded RTC's time data for time management such as the system's operating history or failure history, etc. The RTC's current time is updated every scan based on the operation status information flag of the system.

### 2.4.1 How to use the RTC Function

#### (1) Read/Set clock data

##### (a) Read/Set from XG5000

- 1) Click 『Online』 - 『Diagnosis』 - 『PLC information』 .
- 2) Click the PLC clock tab of 『PLC information』 .

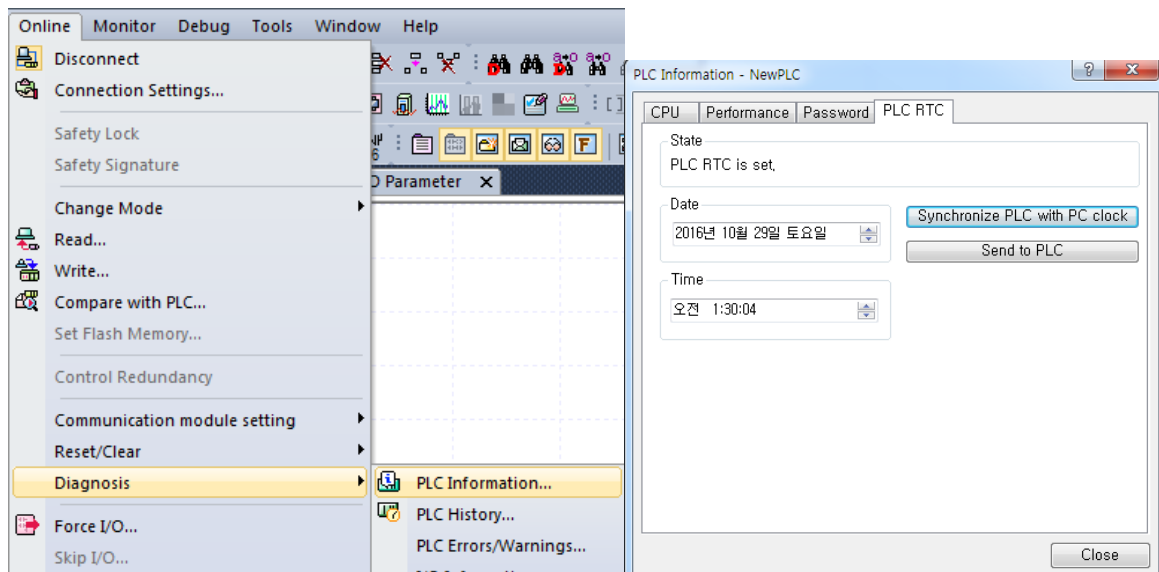

- 3) If you want to transfer the PLC's time to the PLC, click the PC clock and synchronization button.
- 4) If you want to set up your preferred time, after changing the set values of the data and time box, click them to the PLC.

##### (b) Read with the special relay

You can monitor the data with the special relay as below.

Word	Flag Name	Name	Data	Description
F053	_MON_YEAR	Clock data (month/year)	H0709	Sep, 2007
F054	_TIME_DAY	Clock data (hour/day)	h1214	14:00, 12th
F055	_SEC_MIN	Clock data (second/minute)	H2040	20 minutes 40 seconds
F056	_HUND_WK	Clock data (Year/day)	H2003	2000s,Wed.

## (c) Example of changing the clock data through programs

You can change the clock data through the programs as below.

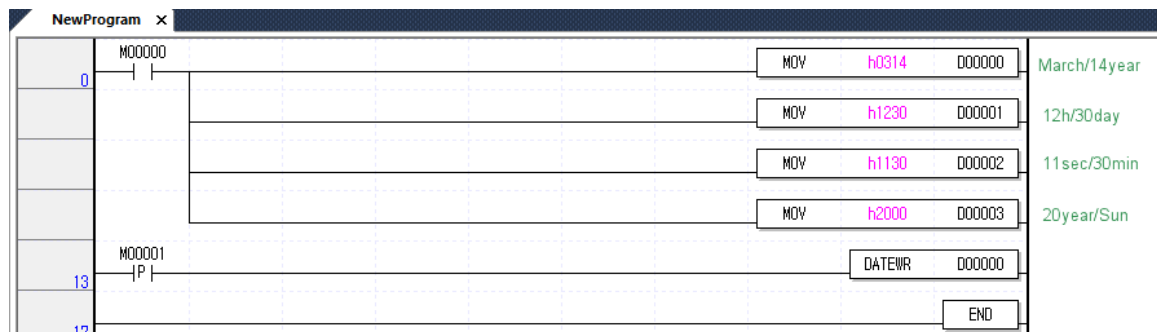

Area	Item	Input data	Description
D0000	Year, Month	h'0314	Mar./2014
D0001	Day, Hour	h'1230	12:00/30 <sup>th</sup>
D0002	Second, Minute	h'1130	11 seconds/30 minutes
D0003	Year, Day	h'2000	2000s /Sun.

Input the clock data in the random devices (P,M,K,L,Z,U,D,R) and turn On/Off the DATEWR input contact M0001. (In case the date and day are not matched, Write is not allowable)

Check whether the data was correctly changed by monitoring the above special areas (F053~F056).

## (d) How to express the day

No.	0	1	2	3	4	5	6
Day	Sun.	Mon.	Tue.	Wed.	Thu.	Fri.	Sat.

## (2) Time error

The RTC's error is different depending on the service temperature.

temperature	max error(sec/day)	normal condition(sec/day)
0°C	-4.67 ~ 1.56	-1.55
25°C	-3.11 ~ 1.96	0.58
55°C	-10.37 ~ -1.56	-5.97

## Notice

- The clock data may not be stated in the shipped product so you need to set up the clock data correctly before use.
- If you write unserviceable clock data in the RTC, it will not work properly.  
Ex.) 25:00, 32<sup>th</sup>, 14 month
- In case the RTC stops or error occurs due to a battery failure, if you write the new clock data in the RTC, the error will be cleared.

## 2.5 Timer counter function

### 2.5.1 Timer Function

The high performance XGB's timer is the additional timer increasing the current value depending on the measuring time. There are 5 available timer types; On delay timer (TON), Off delay timer (TOFF), Cumulative (TMR), Monostable (TMON), retriggerable (TRTG).

The measurable time ranges by timers are as below.

	100ms timer	10ms timer	1ms timer
Range	0.1 seconds ~ 6553.5 seconds	0.01 seconds ~ 655.35 seconds	0.001 seconds ~ 65.535 seconds

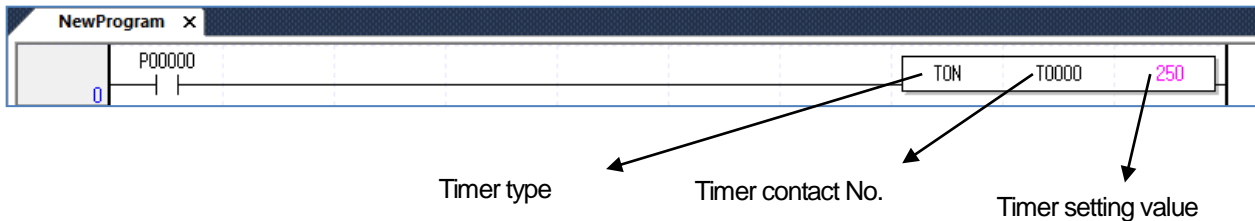

#### (1) Updating the current value of On delay timer and contact On/Off

If the input contact is On, the current value starts to increase. When the current value reaches the set time (PT) (current value=set value), the timer's output contact (Txxx) will be On. When the input contact is Off while the current value increases, the timer's current value will be 0. The timing chart of the On delay timer is as below.

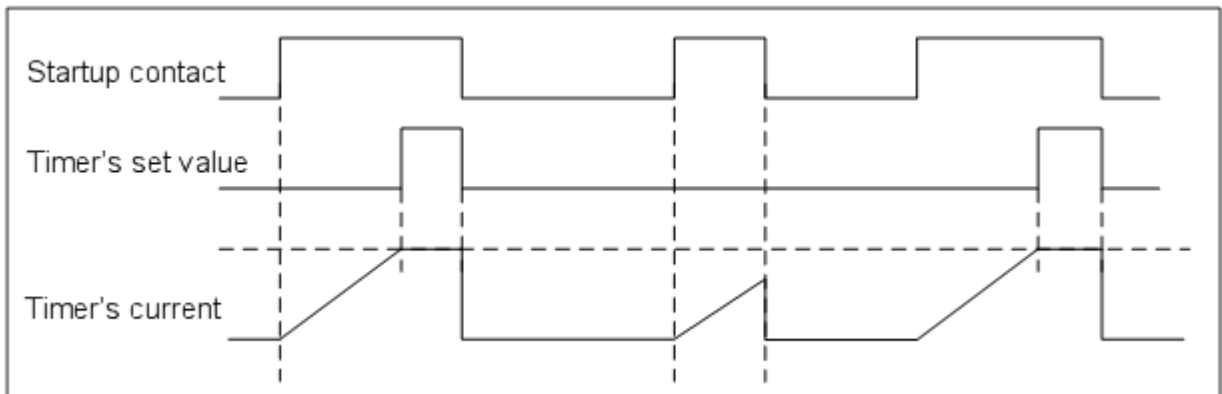

## (2) Updating the current value of Off delay timer and contact On/Off

If the input condition is On, the timer's output contact (Txx) is On and the current value becomes the set value. When the input contact is Off, the current value starts to decrease and if the elapse time reaches the set time (PT (current value=0)), the timer's output contact (Txx) will be Off. If the input contact is On while the current value decreases, the current value becomes the set value.

The timing chart of the Off delay timer is as below.

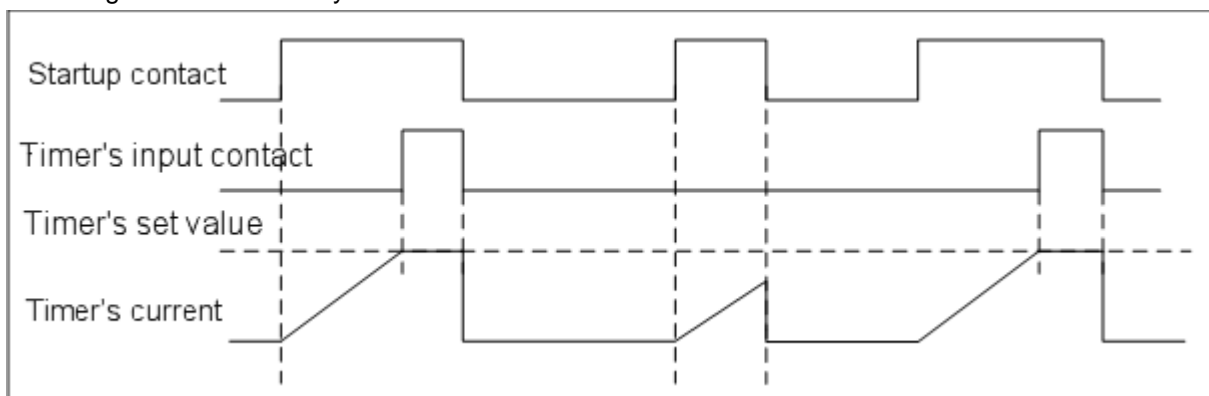

## (3) Updating the current value of Cumulative timer and contact On/Off

The current value increases only when the input contact is On and if the cumulative value reaches the timer's set time (PT), timer output contact is on. The timer output contact maintains the On status until it is Off by the reset coil (IL : RST command). The timing chart of the Cumulative timer is as below.

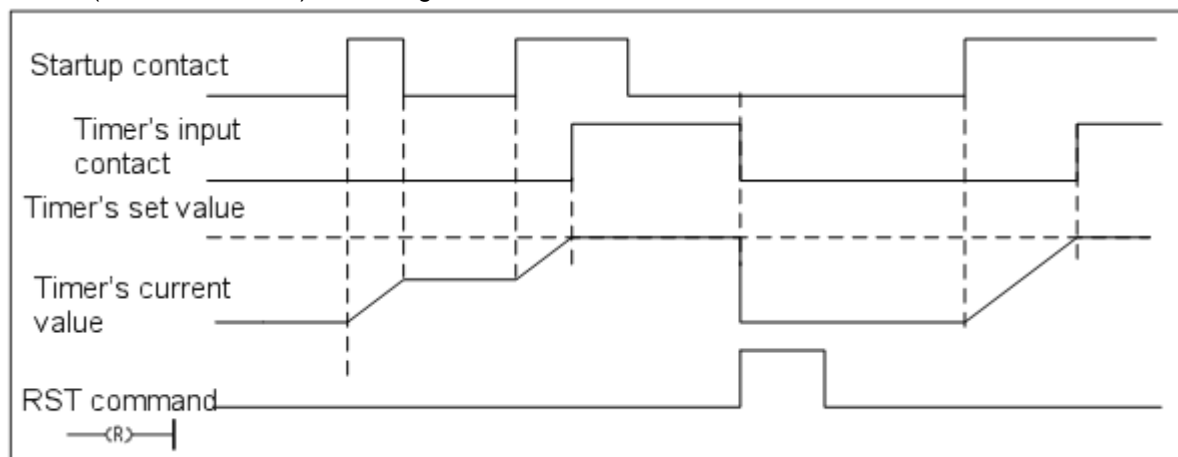

## (4) Updating the current value of Monostable timer and contact On/Off

If the input condition is On, the timer's output contact (Txx) is On. When the timer's current value starts to decrease from the set value (PT) and it becomes 0, the output contact is Off. The change of On/Off of the input contact is regarded until the current value reaches 0. The timing chart of the Monostable timer is as below.

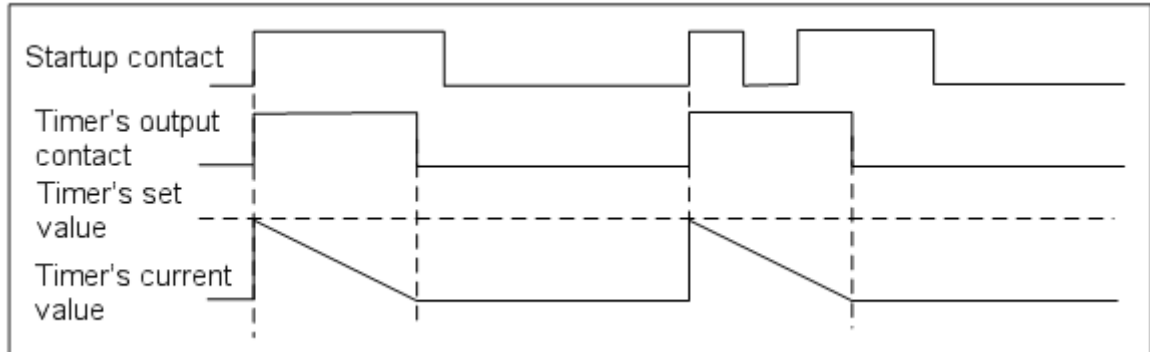

## (5) Updating the current value of retriggerable timer and contact On/Off

If the input condition is On, the timer's (Txx) is On.

When the timer's current value starts to decrease from the set value (PV) and it becomes 0, the output contact is Off. Before the timer's current value becomes "0", the input contact is Off→On again, the timer's current value is updated to the initial set value again. The timing chart of the retriggerable timer is as below.

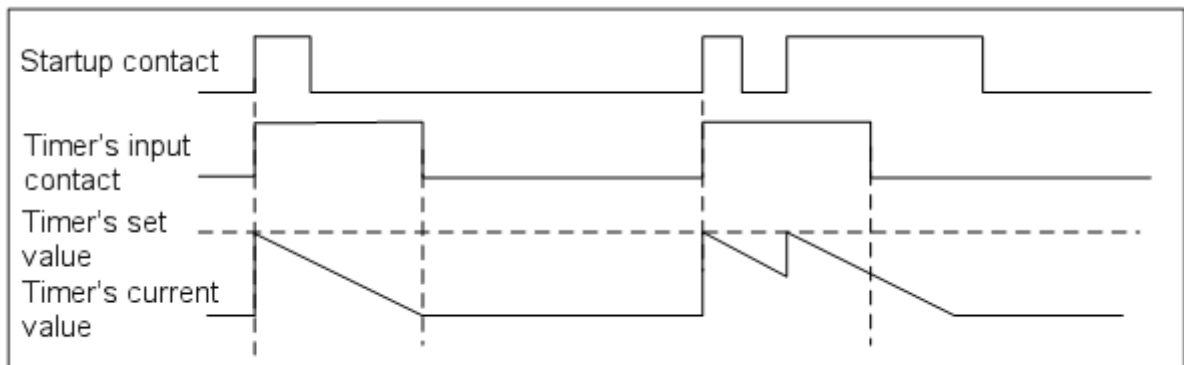

## Notice

- The timer's current value and output processing are executed in the scan END so the maximum error is as below.  
Max. error : 1 scan time + Executing time from the startup of the scan to the timer command step
- For more details on how to use the timer command, refer to the XGB command manual.

## 2.5.2 Counter Function

The CPU part's counter detects the input signal's rising edge (Off→On) and increases/decreases the current value. The high performance XGB PLC supports 4 kinds of counter commands; additional counter (CTU), subtractive counter (CTD), additional-subtractive counter (CTUD), ring counter (CTR).

- The additional counter increases the current value.
- The subtractive counter decreases the current value.
- The additional-subtractive counter increases or decreases the current value depending on the 2 input conditions.
- The ring counter increases the current value and renews the current value as "0" whenever the current value becomes the set value.

(1) Updating the counter's current value and contact On/Off

(a) Additional counter

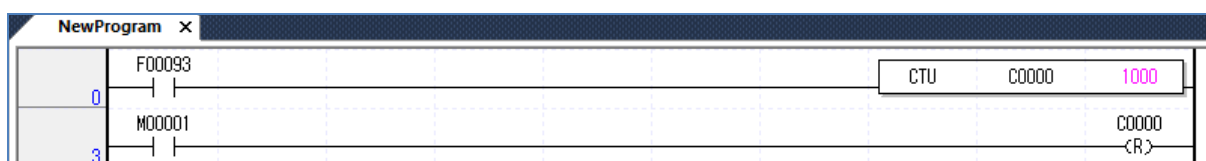

- It increases the current value under the rising edge of the input condition.
- When the current value increases and becomes the same as the set value, the counter's output contact (Cxxx) is On.
- The current value is "0" and the output contact (Cxxx) is Off while the reset signal is On.

(b) Subtractive counter

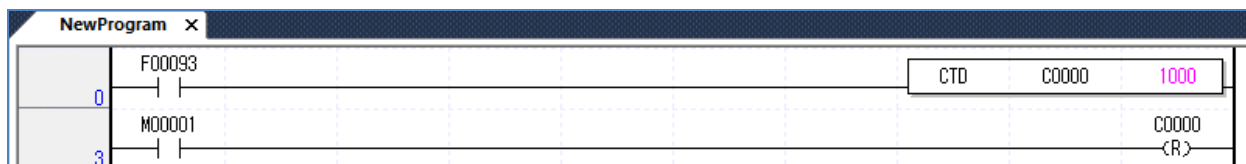

- It decreases the current value of the rising edge of the input condition.
- When the current value decreases and becomes "0", the counter's output contact (Cxxx) is On.
- The current value is "0" and the output contact (Cxxx) is Off while the reset signal is On.

(c) Additional-subtractive counter

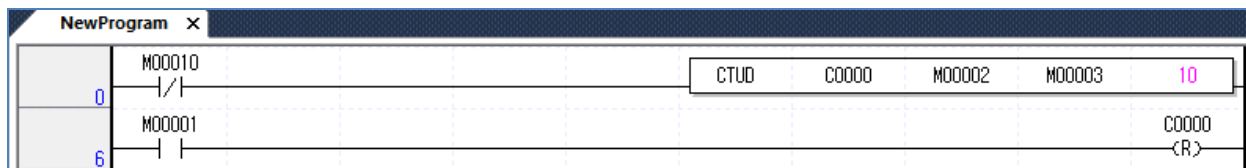

- The current value increases under the rising edge of the additional input condition and the current value decreases under the rising edge of the subtractive input condition. When the current value is greater than or equal to the set value, the output contact Cxxx is On. The current value is smaller than or equal to the set value, the output contact Cxxx is Off.
- The current value becomes 0 in case of reset signal input.

(d) Ring counter

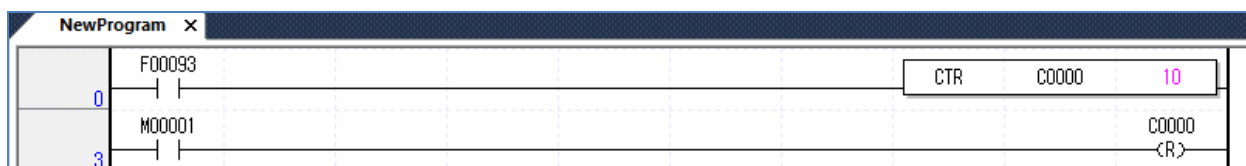

- The current value increases by 1 under the rising edge of the input condition. After the current value reaches the set value, the current value becomes 0 under the rising edge of the next input condition.
- When the current value is the set value, output contact Cxxx is On. Under the rising edge of the next input condition or the rising edge of the reset condition, output contact Cxxx is Off.
- During counting the ring counter, if the reset condition is input, the current value becomes 0.



## (2) Counter's maximum counting speed

The counter's maximum counting speed is determined by the scan time. only when On/Off time of the input condition is greater than the scan time, it can be countable.

Max. counting speed $C_{\max} = \frac{n}{100} \times \left(\frac{1}{t_s}\right)$	$n$ : Duty (%) $t_s$ : scan time[s]
---	--

- The duty (n) puts the input signal's On, Off time ratio on a percentage basis

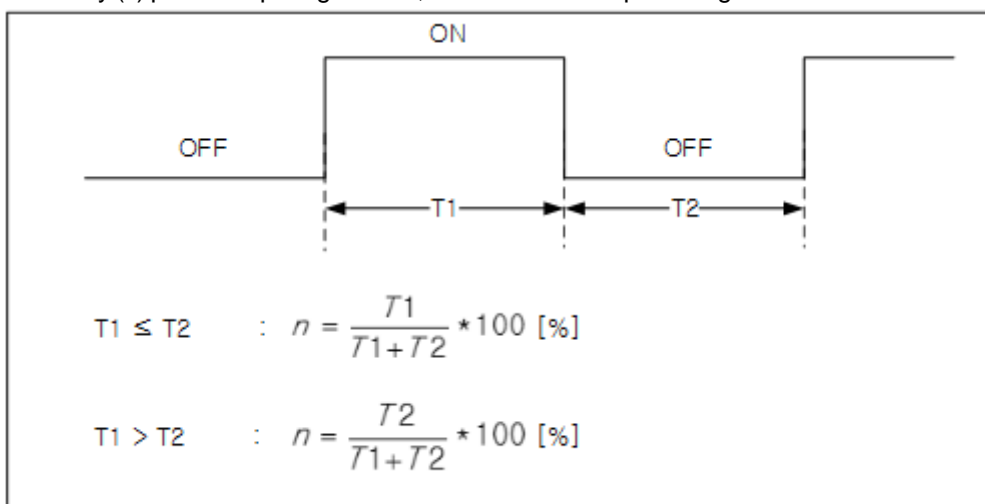
**Notice**

- You are recommended to use the high speed counter function to count the high speed's input pulse accurately that cannot be counted with the counter command

## 2.6 Remote Function

In the high performance XGB basic unit, you can change the operation mode through the key switch attached to the module or through communication. For remote operation, put the basic unit's mode change switch on STOP position.

(1) The kinds of remote operations are as below.

- Access to XG5000 and operation through the USB port installed in the basic unit
- You can operate the other PLCs connected to the network by using the PLC's communication functions when XG5000 is connected to the basic unit.
- You can control the PLC's operation status with HMI software, etc. through the dedicated communication

(2) Remote RUN/STOP

- It is the function to execute RUN/STOP through communication modules through the outside.
- This convenient function can be helpfully used when the PLC is installed in the bad place to operate or you need to RUN/STOP the CPU modules of a control panel from the outside.

(3) Remote DEBUG

- It is the function to execute DEBUG when the operation mode switch is on STOP position. DEBUG is the function to execute the program operation based on the specified operating conditions.
- This convenient function can be helpfully used when you need to check the program's progress or each data's details during the system's debugging works.

(4) Remote reset

- It is the function to reset the CPU module by remote control when errors occur.
- 'Reset' and 'Overall Reset' are available.

### Notice

- For more details on how to operate the remote functions, refer to 'Chap.10 Online' of the XG5000 manual.

## 2.7 I/O forced On/Off Functions

The forced I/O function is used to turn On/Off I/O areas by force regardless of the results of program execution.

### 2.7.1 Forced I/O setting method

Click 『Online』 - 『 Forced I/O setting 』 .

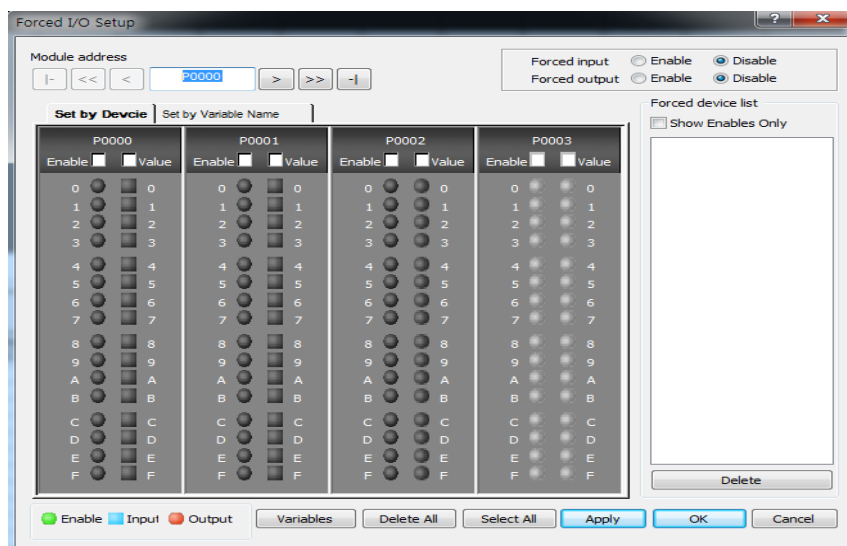

The below table represents the items related to the forced I/O setting.

Item	Description	Remarks
Movement of address	You can select the base and slot.	
Apply	You can set the forced input and output Enable / Unable	
Individual	Flag	You can set the forced I/O Enable / Unable by bit.
	Data	You can set the forced I/O data (On/Off) by bit.
View variables/comments	You can check the set input, output variables.	
Select All	You can set the forced I/O Enable under the condition that the whole I/O areas are On.	
Delete All	You can delete the forced I/O Enable under the condition that the whole I/O areas are Off.	
Set device	It displays the I/O area where even one bit is set.	

### 2.7.2 Time to process the forced I/O On / Off and processing method

#### (1) Forced input

When the forced input is set, among the data read from the input model at the time of Refresh, the data of the contact set as the forced On/Off is replaced by the forced set data to update the input image area. Accordingly, during program operation, among the actual input data, the forced set area is operated with the results replaced by the forced set data.

#### (2) Forced output

After completing the operation of user programs, at the time of output Refresh, among the data of the output

image areas including the operation results, the data of the contact set as the forced On/Off is replaced by the forced set data, and then, they are output. Accordingly, in contrast with the forced input, in the case of the forced output, the data of the output image area shows the same data with the program operation results but the actual output changes by the forced output On/Off settings.

#### (3) Instructions to use the Forced I/O functions

- It works from the time of setting each I/O 'Enable' after setting the forced data.
- Although the actual I/O modules are not equipped, the forced input can be set.
- In spite of Off-> On of the power, change of operation modes and operation by the reset key  
The previously set On/Off data is stored in the PLC.
- Even in STOP mode, the forced input and output data is not eliminated.
- When you try to set the new data from the beginning, cancel all settings of I/O by using 'Delete All' before use.

#### (4) Operations in case of errors

- When errors occur after setting the forced output, it works based on 「Output Hold when errors occur」 of output control settings in the basic parameters and 「Emergency Output」 of the I/O parameters. In case of error occurrence, if you select the emergency output as 「Clear」 after setting Output Hold when errors occur」, the output is off when errors occur; if you choose 「Hold」, the output status will be maintained.
- In case 「Output Hold when errors occur」 is not set in the output control setting of the basic parameters, the output is Off.

## 2.8 Direct I/O Operation Function

I/O contact's Refresh is executed after the scan program is finished. Accordingly, the data of the I/O contact that changes during execution of programs is refreshed to the I/O data of when the END command is executed instead of being refreshed when the data changes.

If you need to immediately refresh the I/O data during execution of the program, through 'IORF' command, you can directly read the input contact status for operation or can directly print out the operation results in the output contact. The below figure indicates the example of the direct I/O operation through the IORF command.

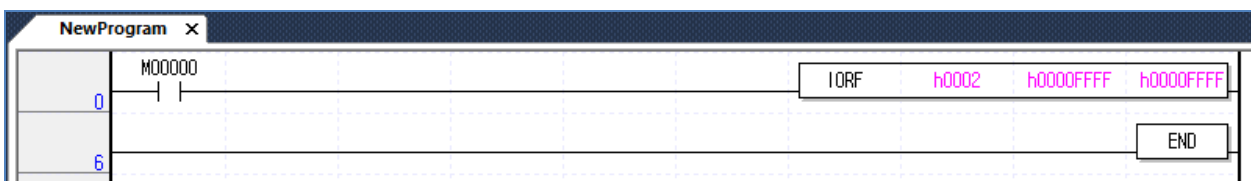

- When M00000 is On, the IORF command is executed and the first operand specifies the slot number. The second operand is the mask data of the upper 32 bits, the third operand is the mask data of the lower 32 bits. You need to set the bit to be refreshed as '1'. The bit set as '0' is not refreshed.

#### Notice

- When you read and write the data in the expansion module through the IORF command, it takes approximately 1~2ms. Accordingly, if the IORF command is used in the fixed cycle task or the external interrupt task program that is input at a short interval, task conflict may occur.
- For more details on the IORF command, refer to the XGK/XGB command manuals.

## 2.9 Function saving the operation history

There are 4 types of operation history; error history, mode conversion history, power down history and system history. The occurrence time, frequency, operating details of each event are saved in the memory and you can conveniently monitor the data through XG5000. The operation history is saved in the PLC unless it is deleted through XG5000.

### 2.9.1 Error history

It saves the error history occurred during operation.

- The error code, date, time, error details are saved.
- The histories can be saved up to 1008 EA.
- It is automatically canceled when the memory backup is cleared due to the battery's low voltage, etc.

### 2.9.2 Mode conversion history

It saves the information on the changed mode and time when changing the operation mode.

- It saves the data, time, mode conversion details.
- The histories can be saved up to 100 EA.

### 2.9.3 Power down history

On or Off time of the power is saved as the ON/OFF information.

- ON/OFF information, date and time are saved.
- The histories can be saved up to 100 EA.

### 2.9.4 System history

It saves the operation history of the system occurred during operation.

- The date, time and details of operation changes are saved.
- The histories related to system operation are saved; XG5000 operation information, change of the key switch position, etc.
- The histories can be saved up to 100 EA.

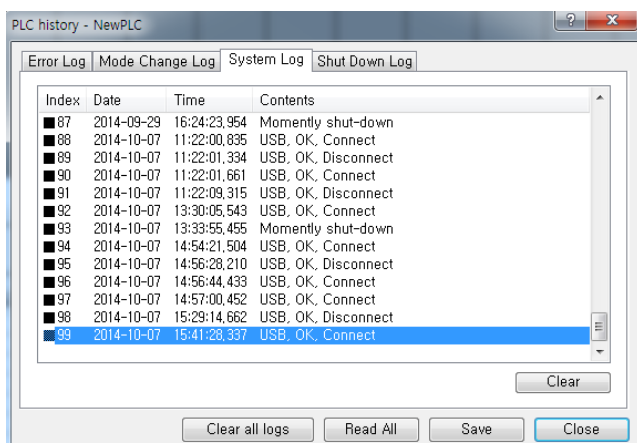

## 2.10 How to allocate I/O No.

Allocation of I/O No. is to allocate the address to each module's I/O terminals to read the data from the input modules and output the data in the output modules when executing operation. In the XGB PLC, all modules occupy 64 points.

### (1) Allocation of I/O No.

The basic unit occupies 2 slots of No.1 so 124 points are allocated and all remaining expansion module occupies 64 points. (including special, communication modules)

Example of allocating I/O No. based on the system configuration

Slot No.	Model	I/O allocation	Remarks
0	XBC-DN32H	input : P0000 ~ P001F output : P0020 ~ P003F	Fixed as the basic unit
1	Embedded special functions	P0040~P007F	-
2	XBE-DC32A	input : P0080~P011F	Actual input : P0080 ~ P009F
3	XBE-TN32A	output : P0120 ~ P015F	Actual output : P0120 ~ P013F
4	XBL-C21A	P0160 ~ P019F	-
5	XBF-AD04A	P0200 ~ P023F	-
6	XBF-DV04A	P0240 ~ P027F	-
7	XBE-DC32A	input : P0280 ~ P031F	Actual input : P0280 ~ P029F
8	XBE-TN32A	output : P0320 ~ P035F	Actual output : P0320 ~ P033F

\* The number of empty I/O points can be used as the internal relay.

\* In the case of the high performance XGB basic type, it does not have the embedded special function corresponding to No.1 slot but occupies No.1 slot as an empty slot.

(2) When the I/O of the I/O parameter is allocated, the allocation information is displayed.

### 2.11.1 Modification Procedures during RUN

Program Modification during operation (Modification during RUN)

You can modify the programs and communication parameters without stopping control operations during running the PLC. The below describes the basic modification method. For more details on Modification during RUN, refer to the XG5000 manual.

The items that can be modified during RUN are limited to programs, network parameters. You cannot modify adding tasks, deletion, parameters, etc. during RUN.

(1) It shows the currently running program.

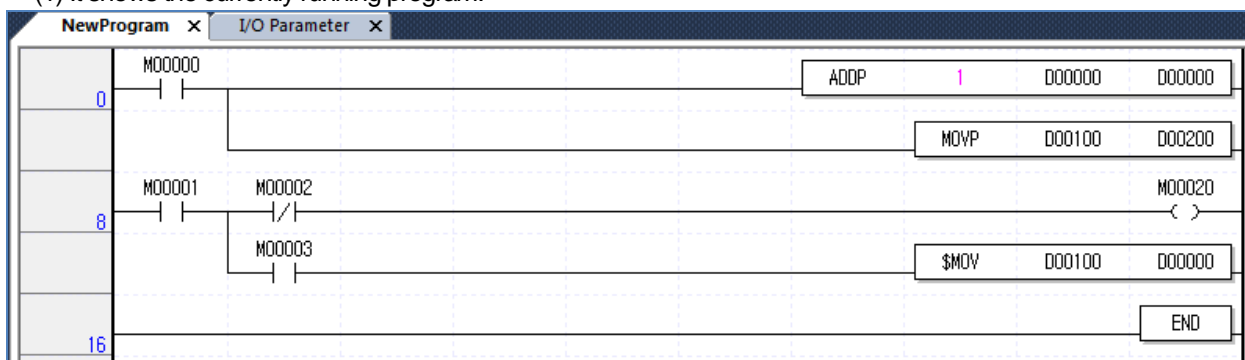

(2) Click 『Online』 - 『Start Modification During RUN』 .

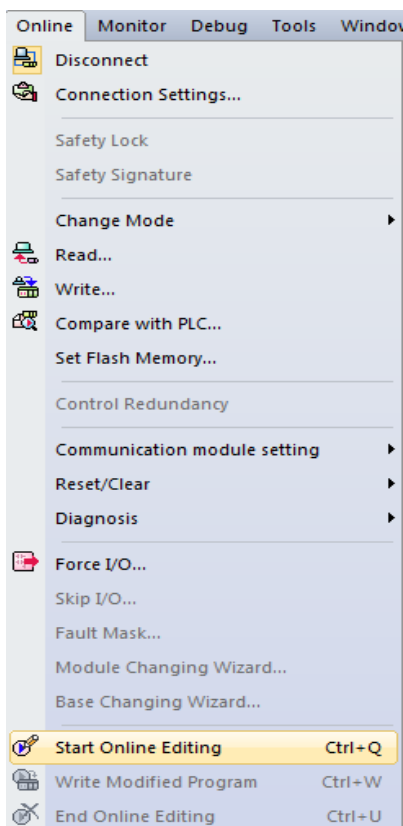

## Chapter 2 CPU Function

(3) Then, the background color of the program window changes and it is converted into the mode of modification during RUN.

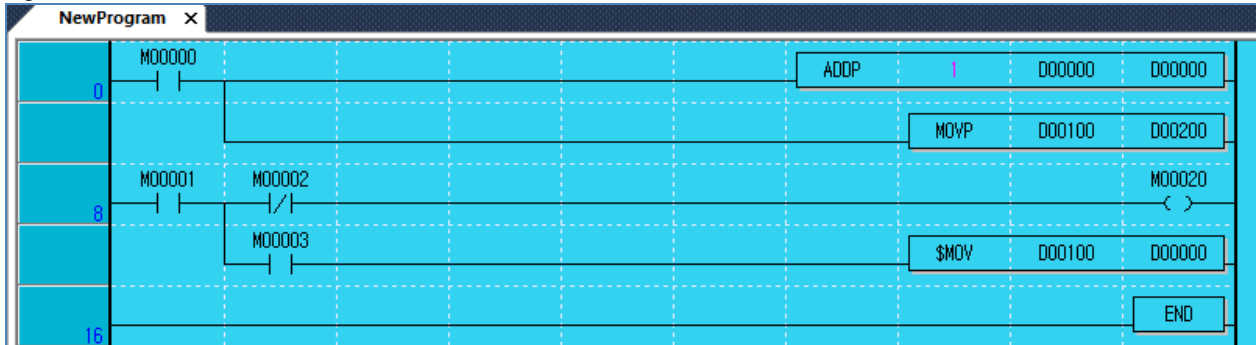

(4) You can modify the program.

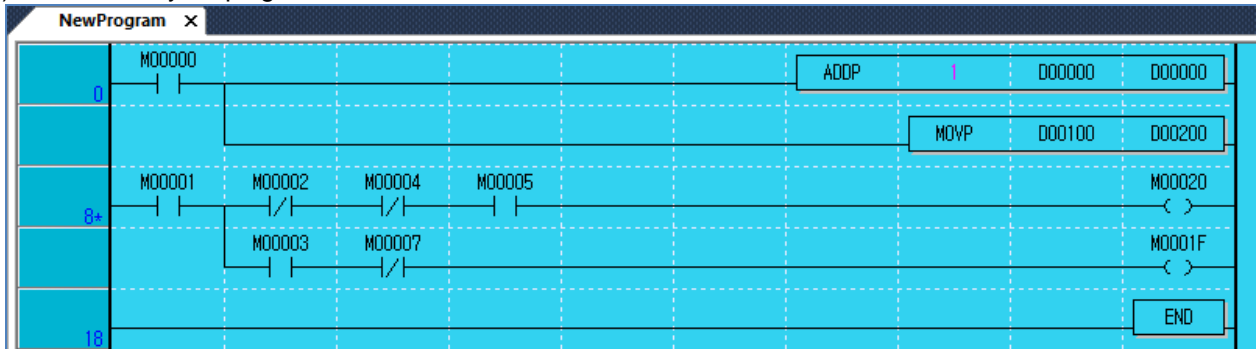

(5) When the modification of the program is completed, click 『Online』 - 『Write Modification During RUN』

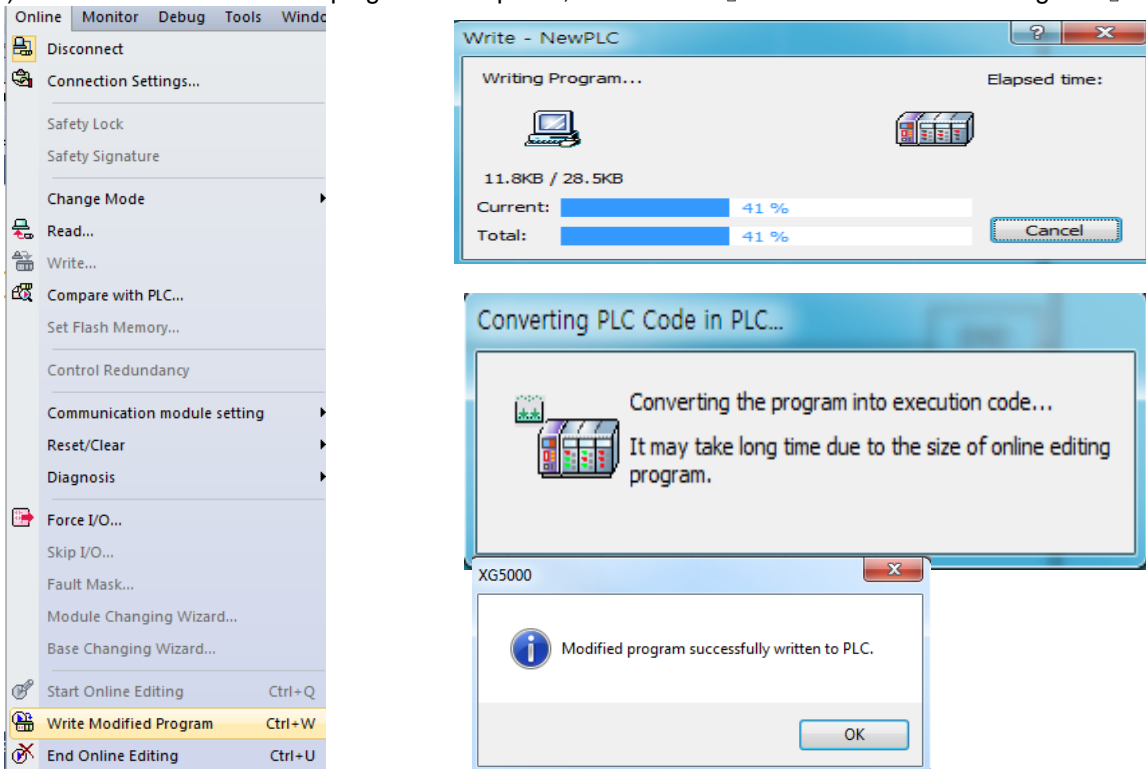



(6) When Write Program is completed, click 『Online』 - 『End Modification During RUN』 .

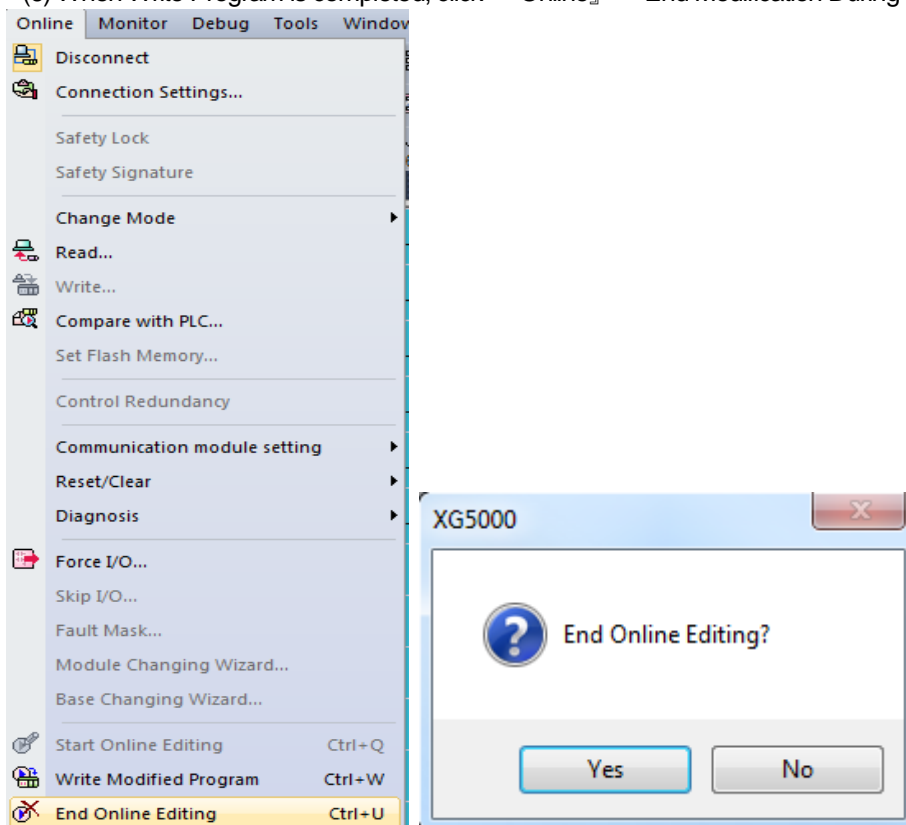

(7) The background color of the program window changes into the original one and modification during RUN is completed.

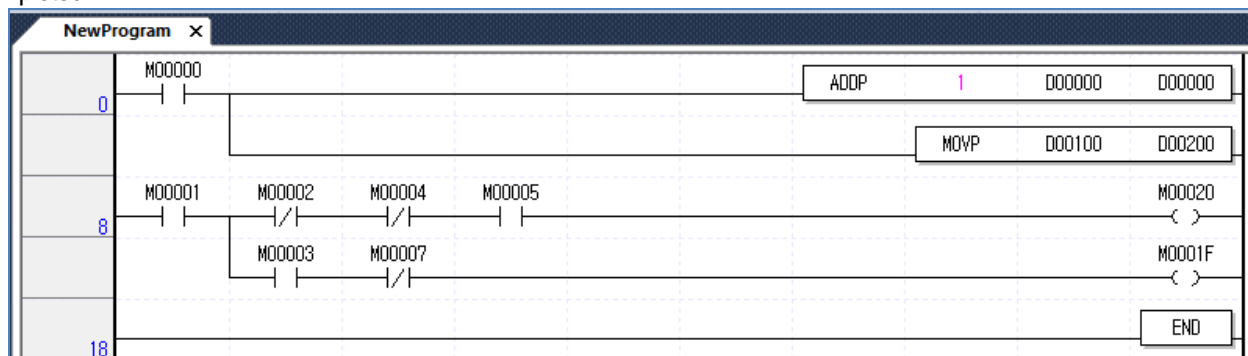

#### Notice

- For Modification of communication parameters during RUN, after changing the network configuration items of XG5000 in the RUN status without going into the Modification during RUN menu, click 『Online』 - 『Write』 and choose 'Network Parameter' to execute Write.

## 2.11 Read I/O information

It is the function to monitor each module's information comprising the XGB PLC system.

(1) If you click 『Online』 - 『I/O Information』, the information of each module of connected systems will be monitored.

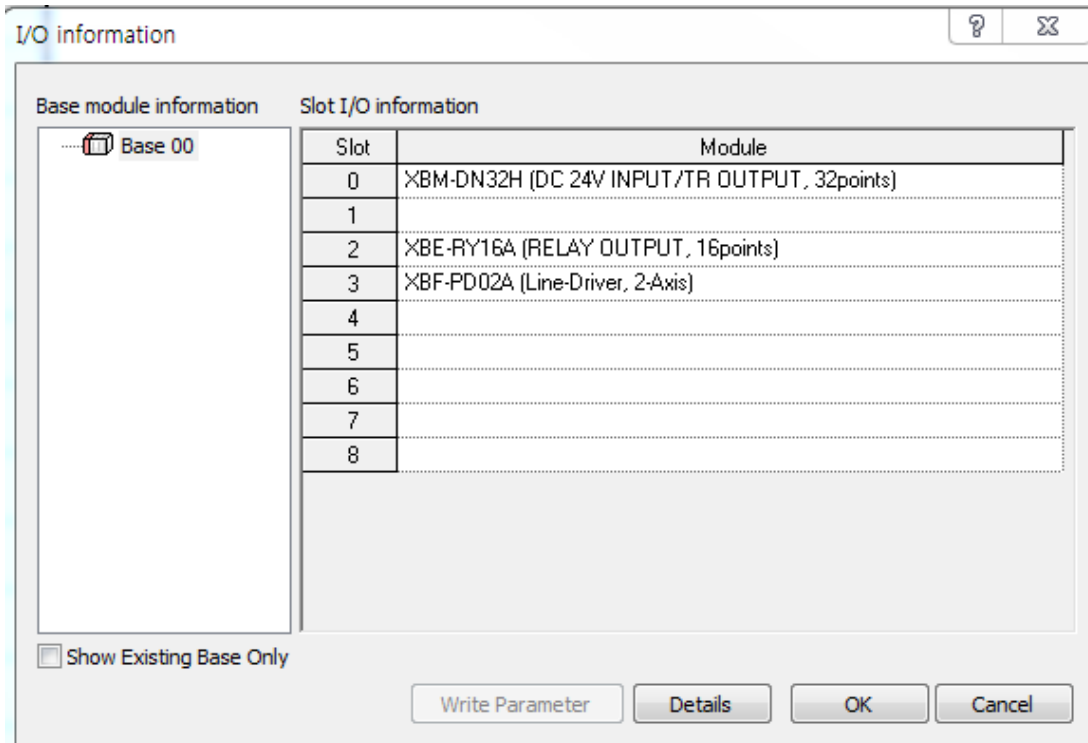

(2) If you click 'Detailed Information' after choosing the module, the details on the module will be displayed.

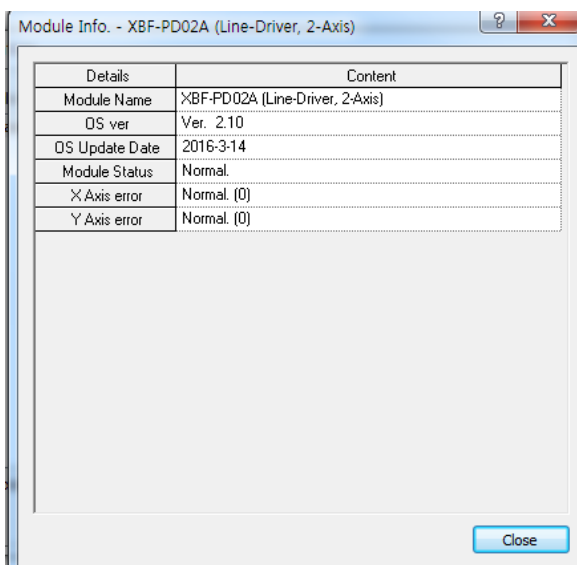

## 2.12 Monitoring Functions

It is the function to monitor the XGB PLC system's general information.

(1) If you click 『Monitor』, the submenu will be displayed as below.

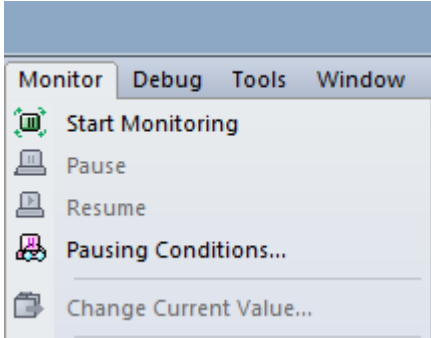

(2) The below table provides the descriptions on each item.

Items	Descriptions	Remarks
Start/End monitor	Specifies the startup and end of the monitor.	Changes every time you click
Suspend monitor	Suspends the monitor.	
Restart monitor	Executes the suspended monitor again.	
Monitor suspension setting	It is the function to suspend the monitor when the set device's value is matched with the conditions.	Restarts when you click 'Restart Monitor'
Changing the current value	Changes the currently selected device's current value.	
System monitor	Monitors the current system's general information.	
Device monitor	It is the function to monitor each device.	
Trend monitor	Monitors the set device's trend.	
User event	Monitors the set device's value when the event specified by a user occurs.	For more details, refer to the XG-5000 manual.
Data trace	Traces the set device's value.	

(a) Changing the current value

It is the function to change the current value of each selected device in the program window.

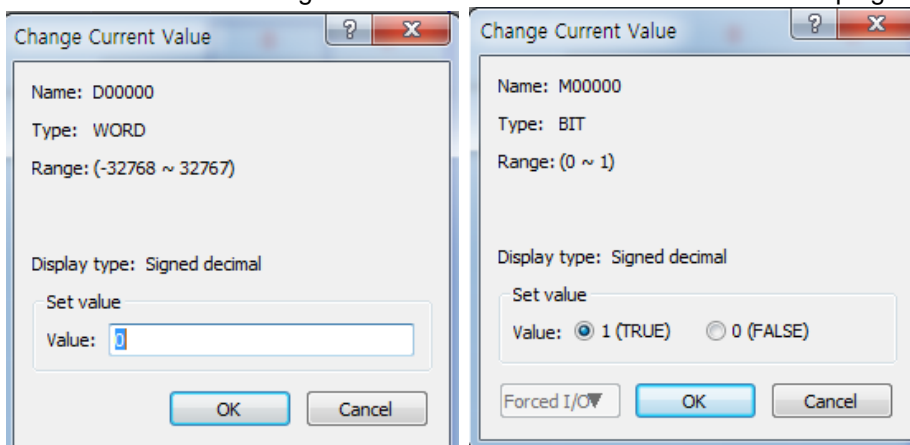

## Chapter 2 CPU Function

### (b) Device monitor

It is the monitoring function by device.

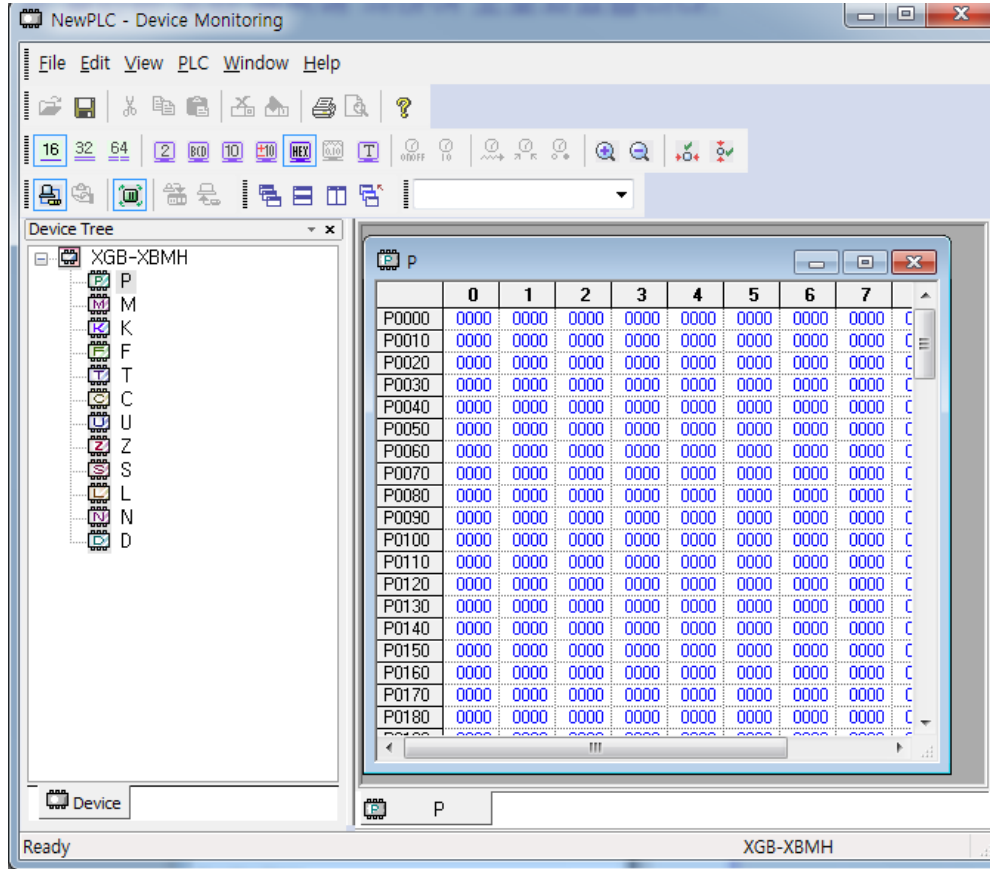

### (c) Monitor suspension setting

It is the function to stop monitoring when the set device value is matched.

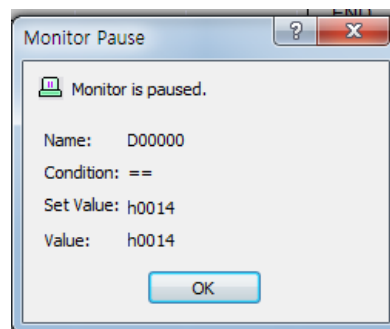
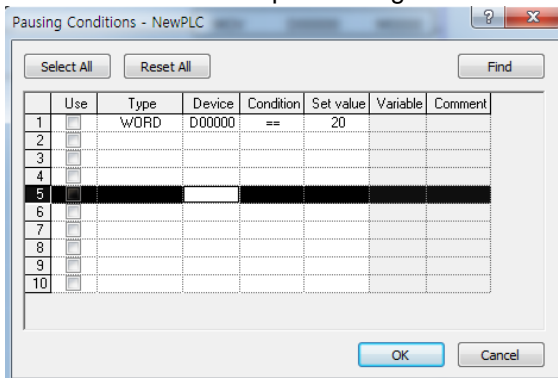

(d) Trend Monitor

It is the function to represent the set device value in a graphic form. The value represented on the graph is not the data collected by the PLC at the right timing but the value read from XG5000 through the communication function. Accordingly, communication delay can occur so it may not be matched with the actual data collected at the right cycle.

You are recommended to use the Trend Monitor function to check the rough data trend.

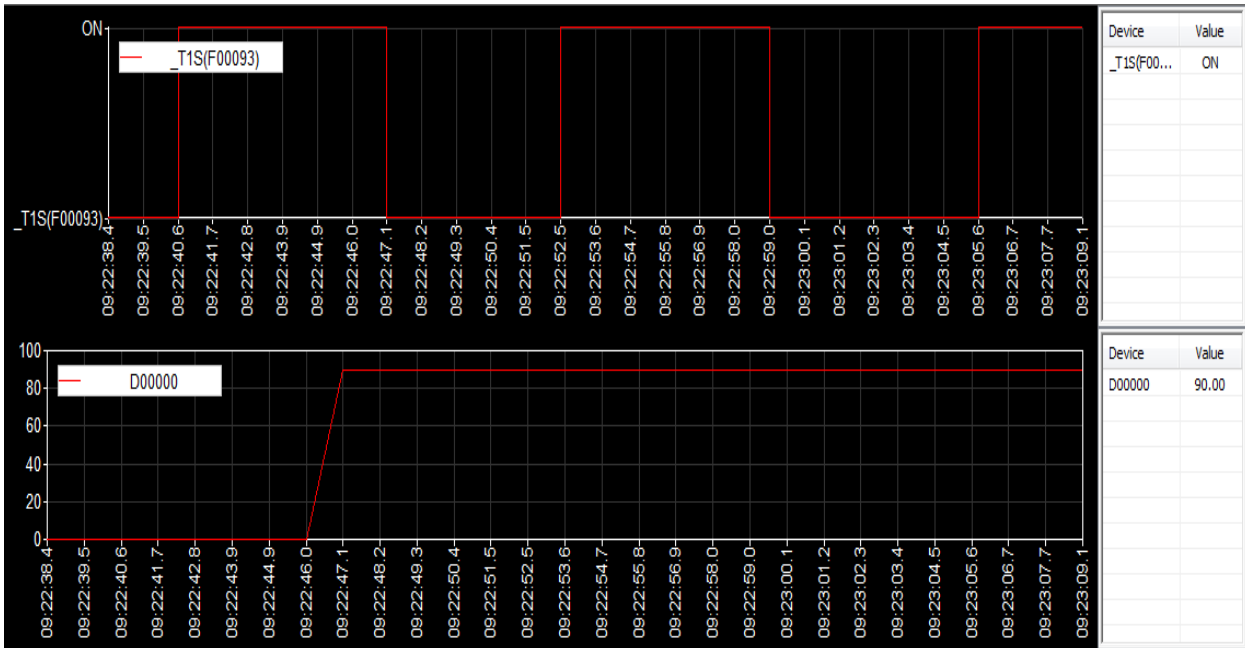

(e) Custom event

1) It is the function to monitor the detailed information when the event set by a user occurs. Register the user event additionally.

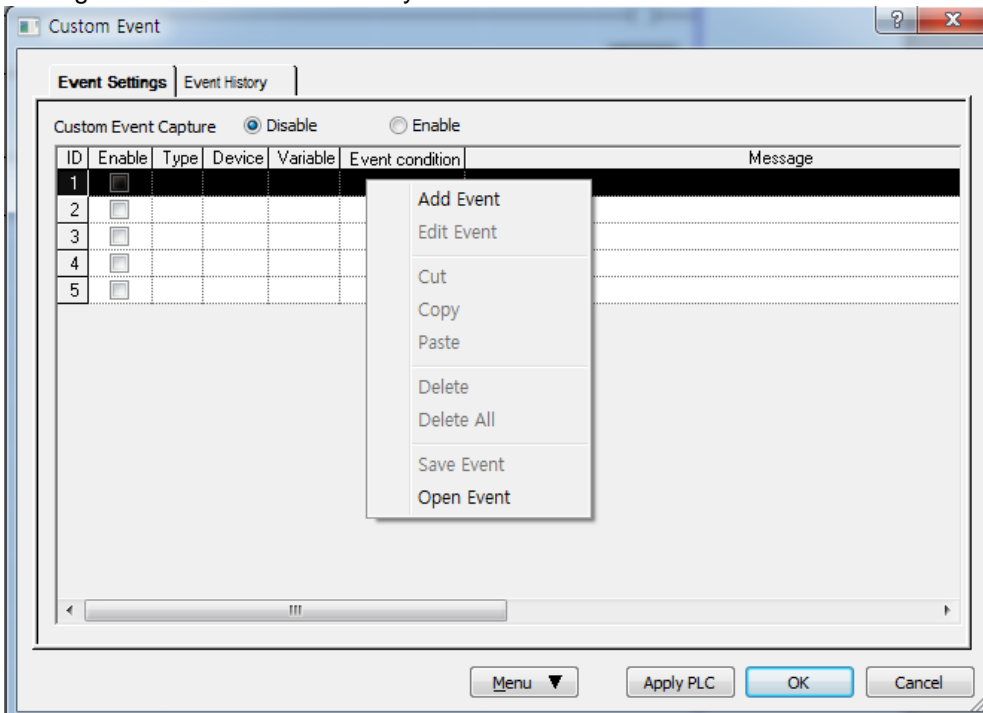

## Chapter 2 CPU Function

- 2) Establish the basic settings and related device.

In case the rising edge of M0000 device occur, the Alarm message “Tank 1 Error-> Please Confirm” is recorded with the then values of D0000,L0000,D0100,N1000 devices.

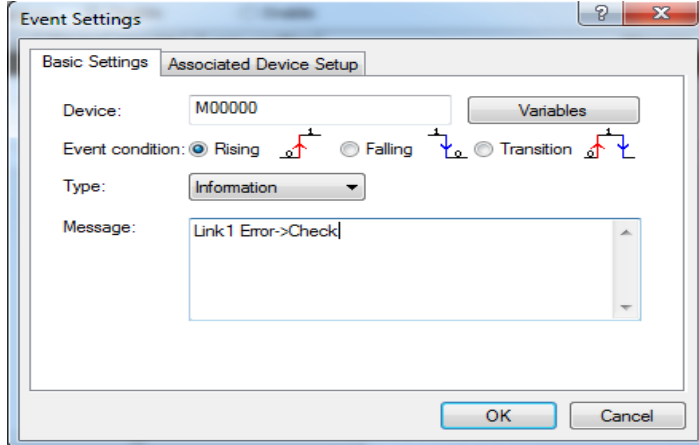

- 3) Set up the associated device.

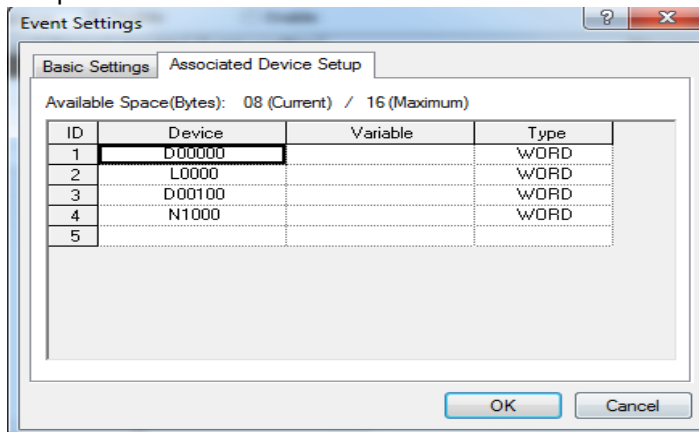

- 4) It monitors the user event history.

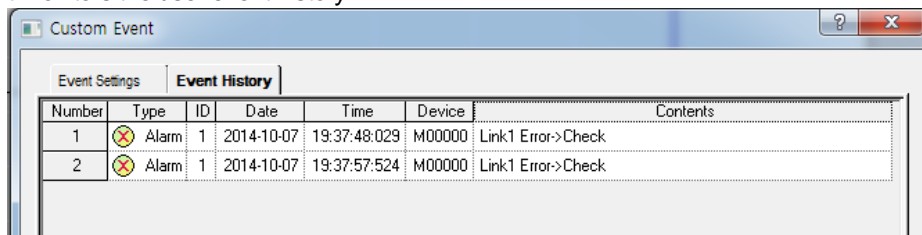

- 5) If you double-click the occurrence number, the detailed value of the device at the time of occurrence will be monitored with the details as below.

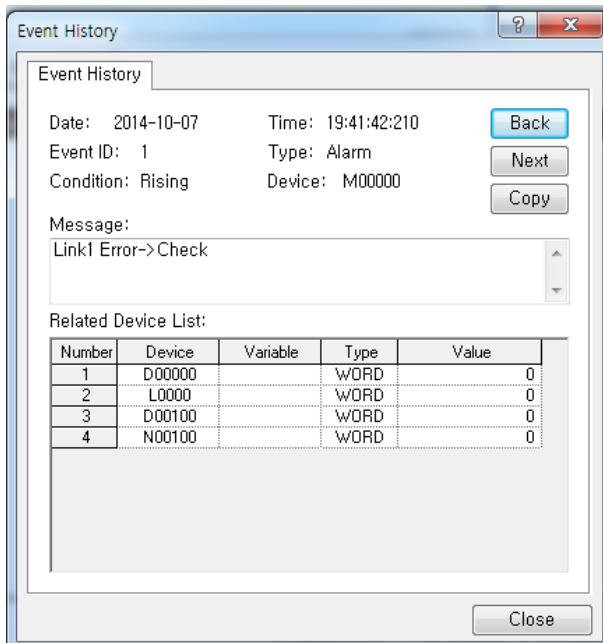
**Notice**

- For more details on the monitor, refer to the XG5000 manual.

## 2.13 PLC's Read-Protect Function

The PLC's Read-Protect function is the function to prohibit the upload of comment, parameter, program downloaded to the PLC. If this function is set up, the use of the functions such as Open from PLC, Read PLC, Compare with PLC, etc. are restricted.

### (1) How to set up the PLC's Read-Protect function

(a) Click 『Online』 - 『Write』 .

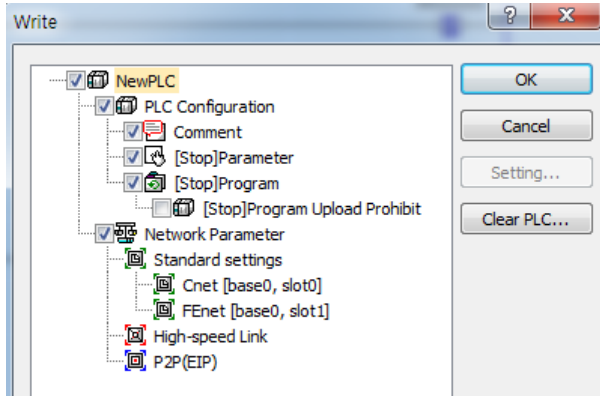

(b) If you choose the program among the items of Write, '[Stop]Program Upload Prohibit' will be activated.

(c) Then, choose '[Stop]Program Upload Prohibit' and click the OK button.

### (2) When you try to read the PLC under the condition that the '[Stop]Program Upload Prohibit' function is set up, the below dialog box will pop up. Reading is not available in the PLC where 'Read-Protect' is set although the password is cleared. Namely, you cannot read the PLC in any way until a new program is applied.

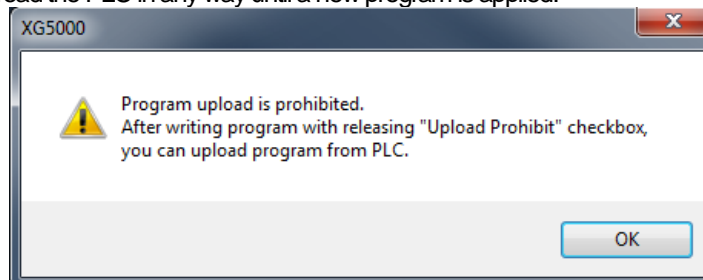

### (3) How to cancel the PLC's '[Stop]Program Upload Prohibit' function

(a) Click 『Online』 - 『Write』 .

(b) Cancel "[Stop]Program Upload Prohibit" and click the OK button.

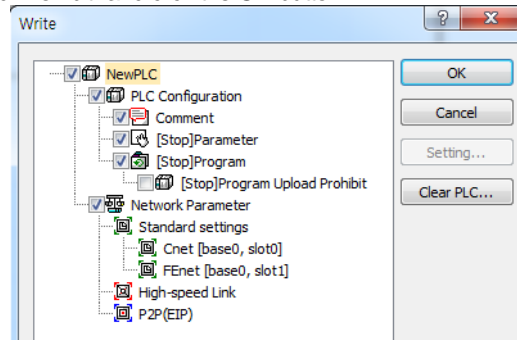



## 2.14 Function to delete all of the PLC

The function to delete all of PLC is the initialization function to delete all programs, parameters, passwords, data stored in the PLC.

(1) How to delete all of PLC

(a) Click 『Online』 - 『Delete all of PLC 』 .

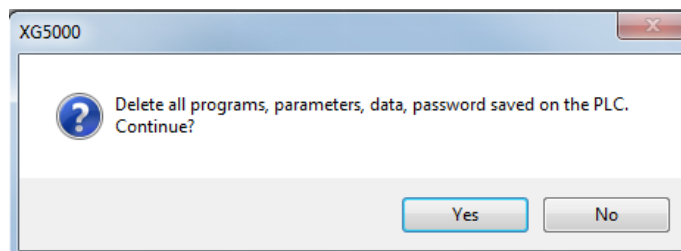

(b) If you choose 『Yes』 in the dialog box, the window for selecting the connection method with the PLC to be deleted is created.

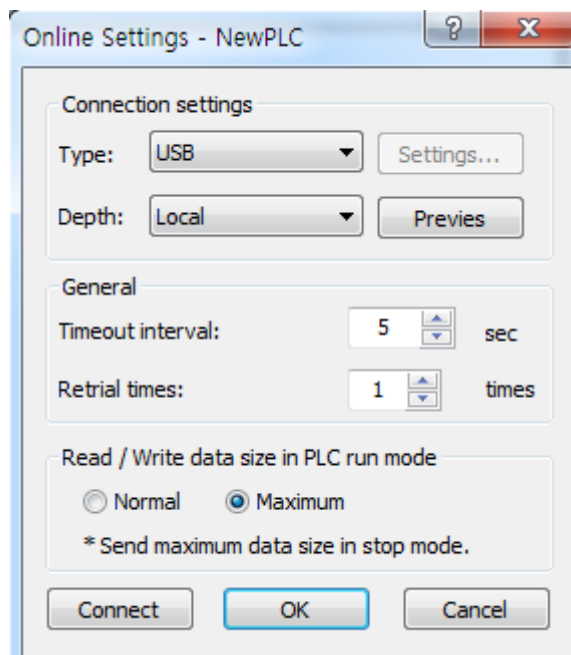

(c) After choosing the connection method with the PLC to be deleted, if you click 『Access』 or 『OK』 , all PLC programs, parameters, data, passwords will be deleted.

### Notice

- Although the initial PLC is not connected, the function is executed. You can connect to the PLC after assess setting.
- If you use the function to delete all of PLC, all PLCs' internal data including passwords will be completely deleted so be careful of this.
- If you use the function to delete all of PLC when the password is lost, it is possible to connect to the PLC so you can reuse the PLC.

## Chapter 3 Input/Output Specifications

### 3.1 Introduction

Here describes the notices when selecting digital I/O module used for XGB series.

- (1) For the type of digital input, there are two types such as current sink input and current source input.
- (2) The number of max. Simultaneous input contact point is different according to module type. It depends on the input voltage, ambient temperature. Use input module after checking the specification.
- (3) When response to high speed input is necessary, use interrupt input contact point. Up to 8 interrupt points are supported.
- (4) In case that open/close frequency is high or it is used for conductive load open/close, use Transistor output module or triac output module as the durability of Relay Output Module shall be reduced.
- (5) For output module to run the conductive (L) load, max. open/close frequency should be used by 1second On, 1 second Off.
- (6) For output module, in case that counter timer using DC/DC Converter as a load was used, Inrush current may flow in a certain cycle when it is ON or during operation. In this case, if average current is selected, it may cause the failure. Accordingly, if the previous load was used, it is recommended to connect resistor or inductor to the load in serial in order to reduce the impact of Inrush current or use the large module having a max. load current value.

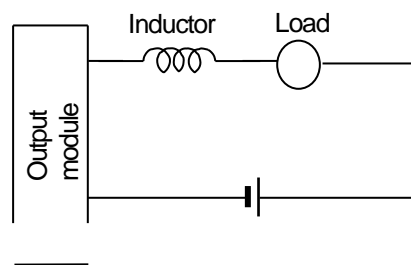
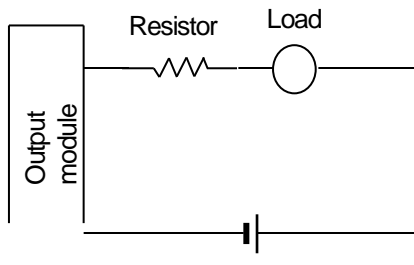

(7) Relay life of Relay output module is shown as below.

Max. life of Relay used in Relay output module is shown as below.

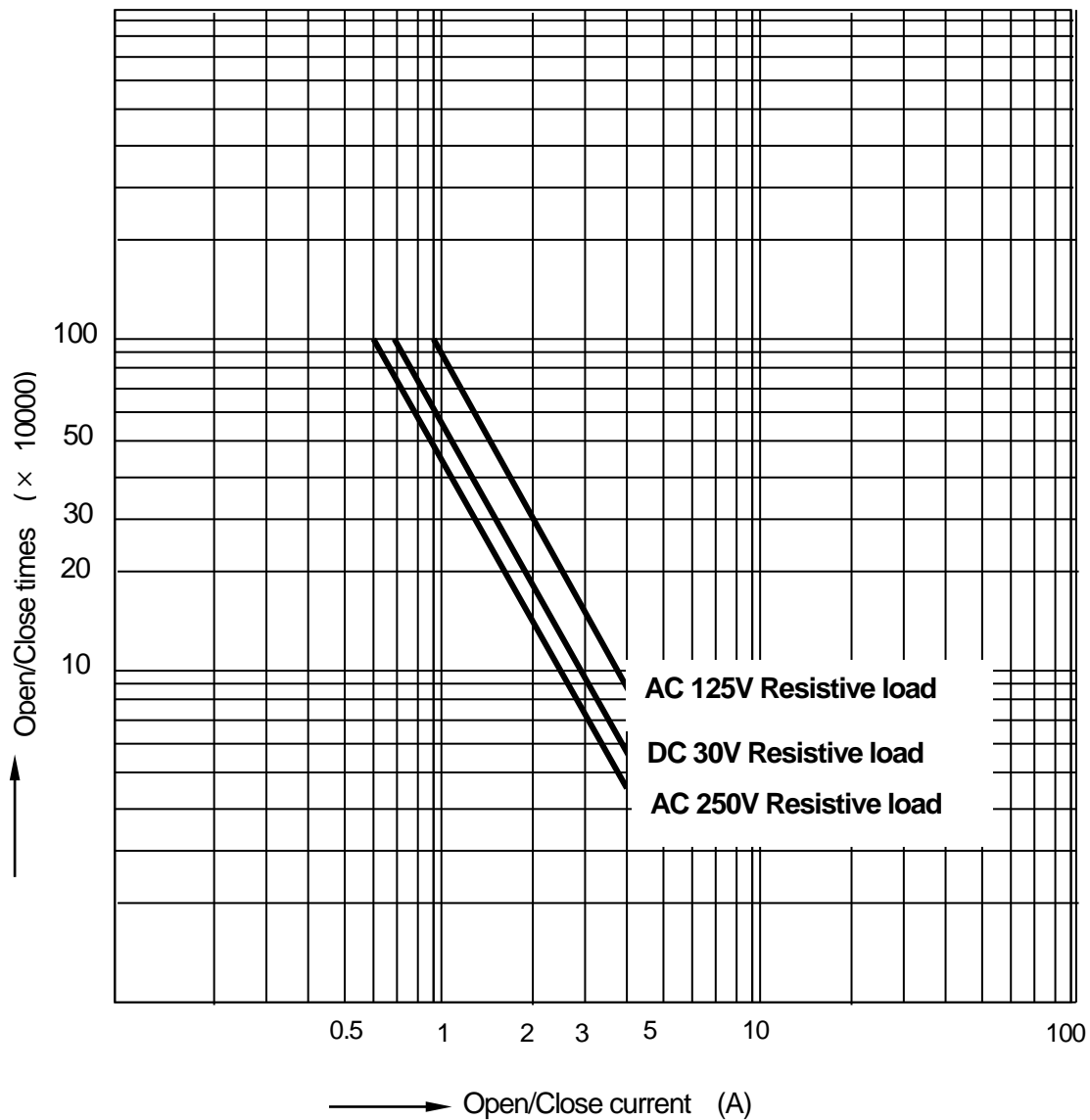

## Chapter 3 Input/Output Specifications

- (8) A clamped terminal with sleeve can not be used for the XGB terminal strip. The clamped terminals suitable for terminal strip are as follows (JOR 1.25-3:Daedong Electricity in Korea).

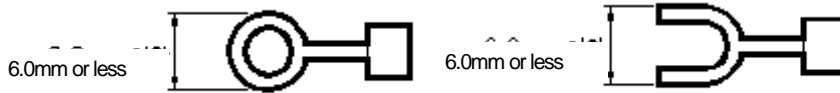

- (9) The cable size connected to a terminal strip should be 0.3~0.75 mm<sup>2</sup> stranded cable and 2.8 mm thick. The cable may have different current allowance depending on the insulation thickness.

- (10) The coupling torque available for fixation screw and terminal strip screw should follow the table below.

Coupling position	Coupling torque range
IO module terminal strip screw (M3 screw)	42 ~ 58 N·cm
IO module terminal strip fixation screw (M3 screw)	66 ~ 89 N·cm

- (11) Relay life graph is not written based on real use.  
(This is not a guaranteed value). So consider margin. Relay life is specified under following condition.



- (a) Rated voltage, load: 3 million times: 100 million times
- (b) 200V AC 1.5A, 240V AC 1A (COS $\phi$  =0.7): 1 million times
- (c) 200V AC 0.4A, 240V AC 0.3A (COS $\phi$  =0.7): 3 million times
- (d) 200V AC 1A, 240V AC 0.5A (COS $\phi$  =0.35): 1 million times
- (e) 200V AC 0.3A, 240V AC 0.15A (COS $\phi$  =0.35): 3 million times
- (f) 24V DC 1A, 100V DC 0.1A (L/R=7ms): 1million times
- (g) 24V DC 0.3A, 100V DC 0.03A (L/R=7ms): 3million times

- (12) Noise can be inserted into input module. To prevent this noise, the user can set filter for input delay in parameter. Consider the environment and set the input filter time.

Input filter time (ms)	Noise signal pulse size (ms)	Reference
1	0.3	Initial value
3	1.8	
5	3	
10	6	
20	12	
70	45	
100	60	

## 3.2 Main Unit Digital Input Specifications

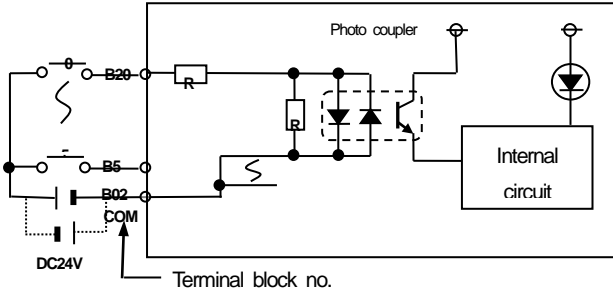
## 3.2.1 XBM-DN32H 16 point DC24V input (Source/Sink type)

Model		Main unit																																																																																							
Specification		XBM-DN32H																																																																																							
Input point		16 point																																																																																							
Insulation method		Photo coupler insulation																																																																																							
Rated input voltage		DC24V																																																																																							
Rated input current		About 4mA (Contact point 0~3: about 5mA)																																																																																							
Operation voltage range		DC20.4~28.8V (within ripple rate 5%)																																																																																							
On voltage / On current		DC19V or higher / 3mA or higher																																																																																							
Off voltage / Off current		DC6V or lower / 1mA or lower																																																																																							
Input resistance		About 5.6kΩ (P00~P03: about 4.7kΩ)																																																																																							
Response time	Off → On	1/3/5/10/20/70/100ms (Set by I/O parameter) Default: 3ms																																																																																							
	On → Off																																																																																								
Insulation pressure		AC560Vrms / 3 cycle (altitude 2000m)																																																																																							
Insulation resistance		10MΩ or more by MegOhmMeter																																																																																							
Common method		16 point / COM																																																																																							
Proper cable size		0.3~0.75mm <sup>2</sup>																																																																																							
Operation indicator		LED On when Input On																																																																																							
External connection method		40point terminal connector																																																																																							
Weight		134g																																																																																							
Circuit configuration					Type																																																																																				
 <p>Terminal block no.</p>					<table border="1"> <thead> <tr> <th>No.</th> <th>Contact</th> <th>No.</th> <th>Contact</th> </tr> </thead> <tbody> <tr><td>B20</td><td>00</td><td>A20</td><td>20</td></tr> <tr><td>B19</td><td>01</td><td>A19</td><td>21</td></tr> <tr><td>B18</td><td>02</td><td>A18</td><td>22</td></tr> <tr><td>B17</td><td>03</td><td>A17</td><td>23</td></tr> <tr><td>B16</td><td>04</td><td>A16</td><td>24</td></tr> <tr><td>B15</td><td>05</td><td>A15</td><td>25</td></tr> <tr><td>B14</td><td>06</td><td>A14</td><td>26</td></tr> <tr><td>B13</td><td>07</td><td>A13</td><td>27</td></tr> <tr><td>B12</td><td>08</td><td>A12</td><td>28</td></tr> <tr><td>B11</td><td>09</td><td>A11</td><td>29</td></tr> <tr><td>B10</td><td>0A</td><td>A10</td><td>2A</td></tr> <tr><td>B9</td><td>0B</td><td>A9</td><td>2B</td></tr> <tr><td>B8</td><td>0C</td><td>A8</td><td>2C</td></tr> <tr><td>B7</td><td>0D</td><td>A7</td><td>2D</td></tr> <tr><td>B6</td><td>0E</td><td>A6</td><td>2E</td></tr> <tr><td>B5</td><td>0F</td><td>A5</td><td>2F</td></tr> <tr><td>B4</td><td>NC</td><td>A4</td><td>P</td></tr> <tr><td>B3</td><td>NC</td><td>A3</td><td>P</td></tr> <tr><td>B2</td><td>IN_COM</td><td>A2</td><td>OUT_COM</td></tr> <tr><td>B1</td><td>IN_COM</td><td>A1</td><td>OUT_COM</td></tr> </tbody> </table>	No.	Contact	No.	Contact	B20	00	A20	20	B19	01	A19	21	B18	02	A18	22	B17	03	A17	23	B16	04	A16	24	B15	05	A15	25	B14	06	A14	26	B13	07	A13	27	B12	08	A12	28	B11	09	A11	29	B10	0A	A10	2A	B9	0B	A9	2B	B8	0C	A8	2C	B7	0D	A7	2D	B6	0E	A6	2E	B5	0F	A5	2F	B4	NC	A4	P	B3	NC	A3	P	B2	IN_COM	A2	OUT_COM	B1	IN_COM	A1	OUT_COM
					No.	Contact	No.	Contact																																																																																	
					B20	00	A20	20																																																																																	
					B19	01	A19	21																																																																																	
					B18	02	A18	22																																																																																	
					B17	03	A17	23																																																																																	
					B16	04	A16	24																																																																																	
					B15	05	A15	25																																																																																	
					B14	06	A14	26																																																																																	
					B13	07	A13	27																																																																																	
					B12	08	A12	28																																																																																	
					B11	09	A11	29																																																																																	
					B10	0A	A10	2A																																																																																	
					B9	0B	A9	2B																																																																																	
					B8	0C	A8	2C																																																																																	
					B7	0D	A7	2D																																																																																	
					B6	0E	A6	2E																																																																																	
B5	0F	A5	2F																																																																																						
B4	NC	A4	P																																																																																						
B3	NC	A3	P																																																																																						
B2	IN_COM	A2	OUT_COM																																																																																						
B1	IN_COM	A1	OUT_COM																																																																																						
																																																																																									

## 3.3 Main Unit Digital Output Specifications

## 3.3.1 XBM-DN32H 16 point transistor output (Sink type)

Specification		Model	Main unit			
			XBM-DN32H			
Output point		16 point				
Insulation method		Photo coupler insulation				
Rated load voltage		DC 12/24V				
Operation load voltage range		DC 10.2 ~ 26.4V				
Max. load current		0.5A / 1 point, position (p00,p01,p02,p03) 0.1A/1 point 2A / 1COM				
Off leakage current		0.1mA or less				
Max. inrush current		4A / 10ms or less				
Max. voltage drop when On		DC 0.4V or less				
Surge absorber		Zener diode				
Response time	Off → On	1ms or less				
	On → Off	1ms or less (rated load, resistive load)				
Common method		16 point / COM				
Proper wire size		Stranded wire 0.3~0.75mm <sup>2</sup> (external diameter 2.8mm or less)				
External power	Voltage	DC12/24V ± 10% (Ripple voltage 4 Vp-p or less)				
	Current	10mA or less (When connecting DC24V)				
Operation indicator		LED On when Output On				
External connection method		4 point terminal block connector				
Weight		134g				
Circuit configuration						
		No.		Contact	Type	
		B20		00		A20
		B19		01	A19	21
		B18		02	A18	22
		B17		03	A17	23
		B16		04	A16	24
		B15		05	A15	25
		B14		06	A14	26
		B13		07	A13	27
		B12		08	A12	28
		B11		09	A11	29
		B10		0A	A10	2A
		B9		0B	A9	2B
		B8		0C	A8	2C
		B7		0D	A7	2D
		B6		0E	A6	2E
		B5		0F	A5	2F
		B4		NC	A4	P
B3		NC	A3	P		
B2		IN_CO M	A2	OUT_ COM		
B1		IN_CO M	A1	OUT_ COM		

## 3.4 Digital Input Specifications

## 3.4.1 8 point DC24V input module (Source/Sink type)

Model		DC input module		
Specification		XBE-DC08A		
Input point		8 point		
Insulation method		Photo coupler insulation		
Rated input voltage		DC24V		
Rated input current		About 4mA		
Operation voltage range		DC20.4~28.8V (ripple rate < 5%)		
On Voltage/Current		DC19V or higher / 3 mA or higher		
Off Voltage/Current		DC6V or less / 1mA or less		
Input resistance		About 5.6kΩ		
Response time	Off → On	1/3/5/10/20/70/100ms (set by CPU parameter) Default: 3ms		
	On → Off			
Insulation pressure		AC560Vrms / 3Cycle (altitude 2000m)		
Insulation resistance		10MΩ or more by Megohmmeter		
Common method		8 point / COM		
Proper cable size		Stranded pair 0.3~0.75mm <sup>2</sup> (External diameter 2.8mm or less)		
Current consumption		30mA (when all point On)		
Operation indicator		Input On, LED On		
External connection method		9 point terminal block connector		
Weight		52 g		
Circuit configuration		No.	Contact	Type
		TB1	0	
		TB2	1	
		TB3	2	
		TB4	3	
		TB5	4	
		TB6	5	
		TB7	6	
		TB8	7	
		TB9	COM	
		TB10	COM	

## 3.4.2 16 point DC24V input module (Sink/Source type)

Specification	Model	DC input module				
		XBE-DC16A	XBE-DC16B			
Input point	16 point					
Insulation method	Photo coupler insulation					
Rated input voltage	DC24V	DC12/24V				
Rated input current	About 4mA	About 4/8mA				
Operation voltage range	DC20.4~28.8V (ripple rate < 5%)	DC9.5~30V (ripple rate < 5%)				
On Voltage/Current	DC19V or higher / 3 mA or higher	DC9V or higher / 3 mA or higher				
Off Voltage/Current	DC6V or less / 1mA or less	DC5V or less / 1mA or less				
Input resistance	About 5.6k $\Omega$	About 2.7k $\Omega$				
Response time	Off $\rightarrow$ On	1/3/5/10/20/70/100ms (set by CPU parameter) Default: 3ms				
	On $\rightarrow$ Off					
Insulation pressure	AC560Vrms / 3Cycle (altitude 2000m)					
Insulation resistance	10M $\Omega$ or more by Megohmmeter					
Common method	16 point / COM					
Proper cable size	Stranded cable 0.3~0.75mm <sup>2</sup> (External diameter 2.8mm or less)					
Current consumption	40mA (when all point On)					
Operation indicator	Input On, LED On					
External connection method	8 pin terminal block connector + 10 pin terminal block connector					
Weight	53 g					
Circuit configuration		No.	Contact	Type		
		TB1	0			
		TB2	1			
		TB3	2			
		TB4	3			
		TB5	4			
		TB6	5			
		TB7	6			
		TB8	7			
				TB1	8	
				TB2	9	
TB3	A					
TB4	B					
TB5	C					
TB6	D					
TB7	E					
TB8	F					
TB9	COM					
TB10	COM					

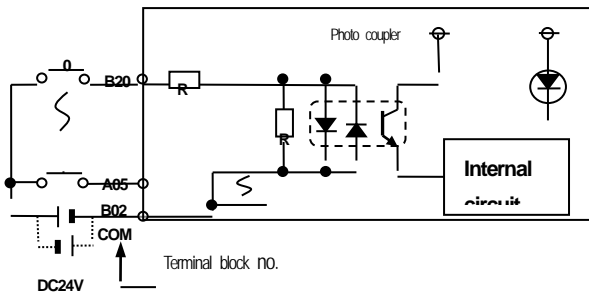
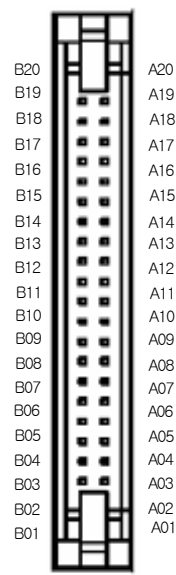
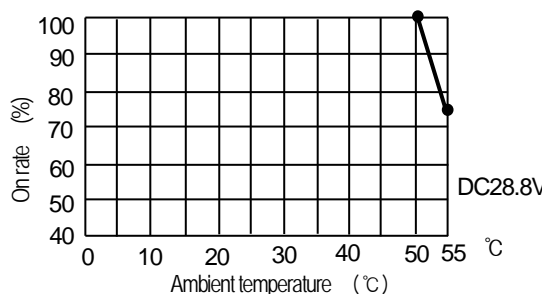

## 3.4.3 32 point DC24V input module (Source/Sink type)

Specification	Model	DC input module				
		XBE-DC32A				
Input point	32 point					
Insulation method	Photo coupler insulation					
Rated input voltage	DC24V					
Rated input current	About 4mA					
Operation voltage range	DC20.4~28.8V (ripple rate < 5%)					
Input Derating	Refer to Derating diagram					
On Voltage/Current	DC 19V or higher / 3 mA or higher					
Off Voltage/Current	DC 6V or less / 1 mA or less					
Input resistance	About 5.6kΩ					
Response time	Off → On	1/3/5/10/20/70/100ms (set by CPU parameter) Default:3ms				
	On → Off					
Insulation pressure	AC 560Vrms / 3 Cycle (altitude 2000m)					
Insulation resistance	10MΩ or more by Megohmmeter					
Common method	32 point / COM					
Proper cable size	0.3mm <sup>2</sup>					
Current consumption	50mA (when all point On)					
Operation indicator	Input On, LED On					
External connection method	40 pin connector					
Weight	60g					
Circuit configuration		No.	Contact	No.	Contact	Type
		B20	00	A20	10	
		B19	01	A19	11	
B18	02	A18	12			
B17	03	A17	13			
B16	04	A16	14			
B15	05	A15	15			
B14	06	A14	16			
B13	07	A13	17			
B12	08	A12	18			
B11	09	A11	19			
B10	0A	A10	1A			
B09	0B	A09	1B			
B08	0C	A08	1C			
B07	0D	A07	1D			
B06	0E	A06	1E			
B05	0F	A05	1F			
B04	NC	A04	NC			
B03	NC	A03	NC			
B02	COM	A02	COM			
B01	COM	A01	COM			
<p>Input Derating diagram</p> 						

## 3.5 Digital Output Specifications

## 3.5.1 8 point relay output module

Model Specification		Relay output module		
		XBE-RY08A		
Output point		8 point		
Insulation method		Relay insulation		
Rated load voltage / Current		DC24V 2A (Resistive load) / AC220V 2A (COS $\Psi$ = 1), 5A/COM		
Min. load voltage/Current		DC5V / 1mA		
Max. load voltage/Current		AC250V, DC125V		
Off leakage current		0.1mA (AC220V, 60Hz)		
Max. On/Off frequency		3,600 times/hr		
Surge absorber		None		
Service life	Mechanical	20 millions times or more		
	Electrical	Rated load voltage / current 100,000 times or more		
		AC200V / 1.5A, AC240V / 1A (COS $\Psi$ = 0.7) 100,000 times or more		
		AC200V / 1A, AC240V / 0.5A (COS $\Psi$ = 0.35) 100,000 times or more		
		DC24V / 1A, DC100V / 0.1A (L / R = 7ms) 100,000 times or more		
Response time	Off $\rightarrow$ On	10ms or less		
	On $\rightarrow$ Off	12ms or less		
Common method		8 point / COM		
Proper cable size		Stranded cable 0.3~0.75mm <sup>2</sup> (External diameter 2.8mm or less)		
Current consumption		230mA (when all point On)		
Operation indicator		Output On, LED On		
External connection method		9 point terminal block connector		
Weight		80g		
<b>Circuit configuration</b>				
		No.	Contact	Type
		TB1	0	
		TB2	1	
		TB3	2	
		TB4	3	
		TB5	4	
		TB6	5	
		TB7	6	
		TB8	7	
		TB9	COM	

## 3.5.2 8 point relay output module (Independent point)

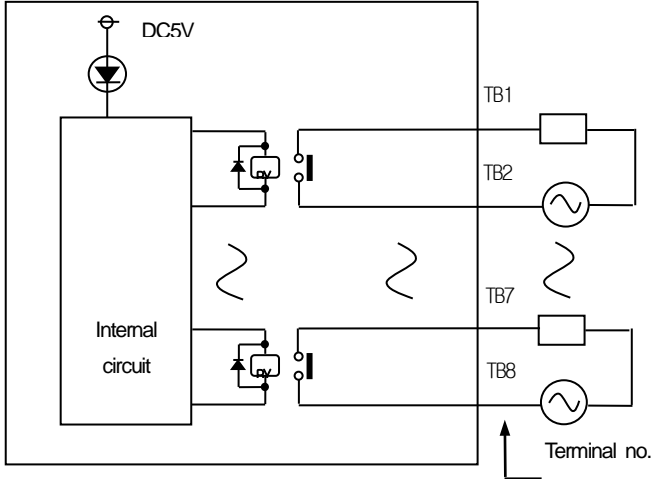
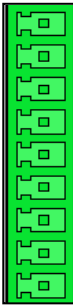
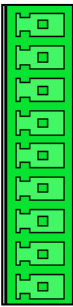
Model Specification		Relay output module		
		XBE-RY08B		
Output point		8 point		
Insulation method		Relay insulation		
Rated load voltage / Current		DC24V 2A (Resistive load) / AC220V 2A (COS $\Psi$ = 1), 2A/COM		
Min. load voltage/Current		DC5V / 1mA		
Max. load voltage/Current		AC250V, DC125V		
Off leakage current		0.1mA (AC220V, 60Hz)		
Max. On/Off frequency		3,600 times/hr		
Surge absorber		None		
Service life	Mechanical	20 millions times or more		
	Electrical	Rated load voltage / current 100,000 times or more		
		AC200V / 1.5A, AC240V / 1A (COS $\Psi$ = 0.7) 100,000 times or more		
		AC200V / 1A, AC240V / 0.5A (COS $\Psi$ = 0.35) 100,000 times or more		
		DC24V / 1A, DC100V / 0.1A (L / R = 7ms) 100,000 times or more		
Response time	Off $\rightarrow$ On	10ms or less		
	On $\rightarrow$ Off	12ms or less		
Common method		1 point / COM		
Proper cable size		Stranded cable 0.3~0.75mm <sup>2</sup> (External diameter 2.8mm or less)		
Current consumption		230mA (when all point On)		
Operation indicator		Output On, LED On		
External connection method		9 point terminal block connector x 2		
Weight		81g		
Circuit configuration				
		No.	<b>Contact</b>	No.
		TB1	0	
		TB2	COM0	
		TB3	1	
		TB4	COM1	
		TB5	2	
		TB6	COM2	
		TB7	3	
		TB8	COM3	
		TB9	NC	
		TB1	4	
		TB2	COM4	
		TB3	5	
		TB4	COM5	
		TB5	6	
		TB6	COM6	
		TB7	7	
		TB8	COM7	
TB9	NC			

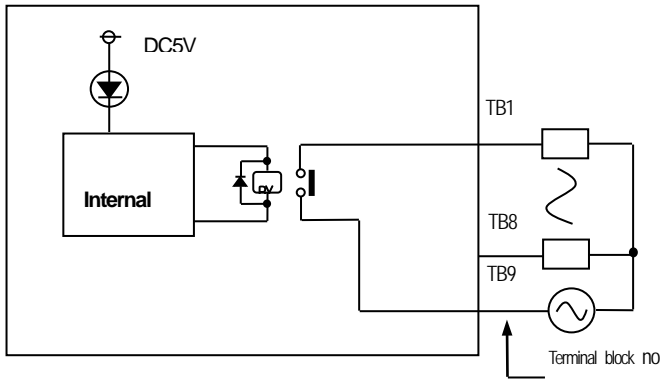
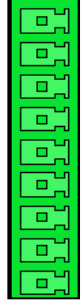
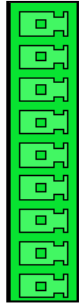

## 3.5.3 16 point relay output module

Specification		Model	Relay output module				
			XBE-RY16A				
Output point		16 point					
Insulation method		Relay insulation					
Rated load voltage/ current		DC24V 2A (Resistive load) / AC220V 2A (COS $\Psi$ = 1), 5A/COM					
Min. load voltage/current		DC5V / 1mA					
Max. load voltage/current		AC250V, DC125V					
Off leakage current		0.1mA (AC220V, 60Hz)					
Max. On/Off frequency		3,600 times/hr					
Surge absorber		None					
Service life	Mechanical	20 millions times or more					
	Electrical	Rated load voltage / current 100,000 times or more					
		AC200V / 1.5A, AC240V / 1A (COS $\Psi$ = 0.7) 100,000 times or more					
		AC200V / 1A, AC240V / 0.5A (COS $\Psi$ = 0.35) 100,000 times or more					
		DC24V / 1A, DC100V / 0.1A (L / R = 7ms) 100,000 times or more					
Response time	Off $\rightarrow$ On	10ms or less					
	On $\rightarrow$ Off	12ms or less					
Common method		8 point / COM					
Proper cable size		Stranded cable 0.3~0.75mm <sup>2</sup> (External diameter 2.8mm or less)					
Current consumption		420mA (when all point On)					
Operation indicator		Output On, LED On					
External connection method		9 point terminal block connector x 2 ea					
Weight		130g					
Circuit configuration					No.	Contact	Type
					TB1	0	
					TB2	1	
					TB3	2	
					TB4	3	
					TB5	4	
					TB6	5	
					TB7	6	
					TB8	7	
					TB9	COM	
					TB1	8	
					TB2	9	
					TB3	A	
					TB4	B	
					TB5	C	
					TB6	D	
					TB7	E	
					TB8	F	
					TB9	COM	

## 3.5.4 8 point transistor output module (Sink type)

Specification		Model	Transistor output module				
			XBE-TN08A				
Output point		8 point					
Insulation method		Photo coupler insulation					
Rated load voltage		DC 12 / 24V					
Load voltage range		DC 10.2 ~ 26.4V					
Max. load voltage		0.5A / 1 point					
Off leakage current		0.1mA or less					
Max. inrush current		4A / 10ms or less					
Max. voltage drop (On)		DC 0.4V or less					
Surge absorber		Zener Diode					
Response time	Off → On	1ms or less					
	On → Off	1ms or less (Rated load, resistive load)					
Common method		8 point / COM					
Proper cable size		Stranded cable 0.3~0.75mm <sup>2</sup> (External diameter 2.8mm or less)					
Current consumption		40mA (when all point On)					
External power supply	Voltage	DC12/24V ± 10% (ripple voltage 4 Vp-p or less)					
	Current	10mA or less (DC24V connection)					
Operation indicator		Output On, LED On					
External connection method		10 point terminal block connector					
Weight		52g					
Circuit configuration					No.	Contact	Type
					TB01	0	
					TB02	1	
					TB03	2	
					TB04	3	
					TB05	4	
					TB06	5	
					TB07	6	
					TB08	7	
					TB09	DC12 / 24V	
					TB10	COM	

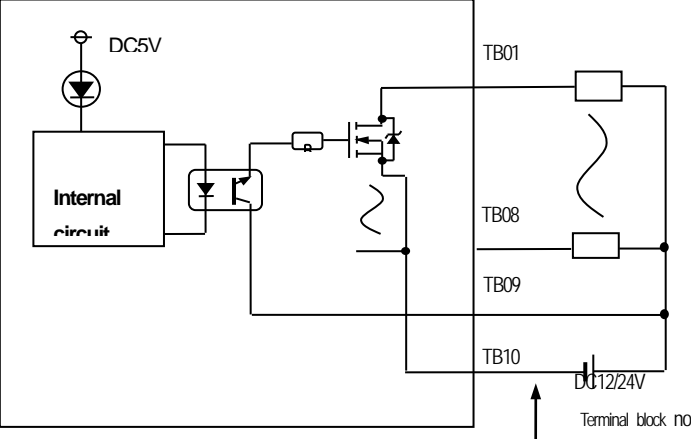
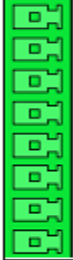
## 3.5.5 16 point transistor output module (Sink type)

Specification		Model	Transistor output module			
			XBE-TN16A			
Output point		16 point				
Insulation method		Photo coupler insulation				
Rated load voltage		DC 12 / 24V				
Load voltage range		DC 10.2 ~ 26.4V				
Max. load voltage		0.5A / 1 point, 2A / 1COM				
Off leakage current		0.1mA or less				
Max. inrush current		4A / 10ms or less				
Max. voltage drop (On)		DC 0.4V or less				
Surge absorber		Zener Diode				
Response time	Off → On	1ms or less				
	On → Off	1ms or less (Rated load, resistive load)				
Common method		16 point / COM				
Proper cable size		Stranded cable 0.3~0.75mm <sup>2</sup> (External diameter 2.8mm or less)				
Current consumption		60mA (when all point On)				
External power supply	Voltage	DC12/24V ± 10% (ripple voltage 4 Vp-p or less)				
	Current	10mA or less (DC24V connection)				
Operation indicator		Output On, LED On				
External connection method		8 pin terminal block connector + 10 pin terminal block connector				
Weight		54 g				
Circuit configuration			No.	Contact	Type	
			TB01	0		
			TB02	1		TB01
			TB03	2		TB02
			TB04	3		TB03
			TB05	4		TB04
			TB06	5		TB05
			TB07	6		TB06
			TB08	7		TB07
			TB01	8	TB08	
			TB02	9		
TB03	A	TB01				
TB04	B	TB02				
TB05	C	TB03				
TB06	D	TB04				
TB07	E	TB05				
TB08	F	TB06				
TB09	DC12 / 24V	TB07				
TB10	COM	TB08				
		TB09				
		TB10				

## 3.5.6 32 point transistor output module (Sink type)

Specification	Model		Transistor output module			
			XBE-TN32A			
Output point			32 point			
Insulation method			Photo coupler insulation			
Rated load voltage			DC 12 / 24V			
Load voltage range			DC 10.2 ~ 26.4V			
Max. load voltage			0.5A / 1 point, 2A / 1COM			
Off leakage current			0.1mA or less			
Max. inrush current			0.7A / 10ms or less			
Max. voltage drop (On)			DC 0.4V or less			
Surge absorber			Zener Diode			
Response time	Off → On			1ms or less		
	On → Off			1ms or less (Rated load, resistive load)		
Common method			32 point / COM			
Proper cable size			0.3mm <sup>2</sup>			
Current consumption			120mA (when all point On)			
External power supply	Voltage			DC12/24V ± 10% (ripple voltage 4 Vp-p or less)		
	Current			20mA or less (DC24V connection)		
Operation indicator			Output On, LED On			
External connection method			40 pin connector			
Weight			60g			
Circuit configuration						
		No.	Contact	No.	Contact	
		B20	00	A20	10	
		B19	01	A19	11	
		B18	02	A18	12	
		B17	03	A17	13	
		B16	04	A16	14	
		B15	05	A15	15	
		B14	06	A14	16	
		B13	07	A13	17	
		B12	08	A12	18	
		B11	09	A11	19	
		B10	0A	A10	1A	
		B09	0B	A09	1B	
		B08	0C	A08	1C	
		B07	0D	A07	1D	
		B06	0E	A06	1E	
		B05	0F	A05	1F	
		B04	NC	A04	NC	
		B03	NC	A03	NC	
		B02	DC12/24V	A02	COM	
B01		A01				

## 3.5.7 8 point transistor output module (Source type)

Specification		Model	Transistor output module				
			XBE-TP08A				
Output point		8 point					
Insulation method		Photo coupler insulation					
Rated load voltage		DC 12 / 24V					
Load voltage range		DC 10.2 ~ 26.4V					
Max. load voltage		0.5A / 1 point					
Off leakage current		0.1mA or less					
Max. inrush current		4A / 10ms or less					
Max. voltage drop (On)		DC 0.4V or less					
Surge absorber		Zener Diode					
Response time	Off → On	1ms or less					
	On → Off	1ms or less (Rated load, resistive load)					
Common method		8 point / COM					
Proper cable size		Stranded cable 0.3~0.75mm <sup>2</sup> (external diameter 2.8mm or less)					
Current consumption		40mA (when all outputs are on)					
External power	Voltage	DC12/24V ± 10% (ripple voltage 4 Vp-p or less)					
	Current	10mA or less (when connecting DC24V)					
Operation indicator		LED on when output on					
External connection method		10 pin terminal block connector					
Weight		30g					
Circuit configuration					No.	Contact	Type
					TB01	0	
					TB02	1	
					TB03	2	
					TB04	3	
					TB05	4	
					TB06	5	
					TB07	6	
					TB08	7	
					TB09	COM	
					TB10	0V	



## 3.5.8 16 point transistor output module (Source type)

Model		Transistor output module		
Specification		XBE-TP16A		
Output point		16 point		
Insulation method		Photo coupler insulation		
Rated load voltage		DC 12 / 24V		
Load voltage range		DC 10.2 ~ 26.4V		
Max. load voltage		0.5A / 1 point, 2A / 1COM		
Off leakage current		0.1mA or less		
Max. inrush current		4A / 10ms or less		
Max. voltage drop (On)		DC 0.4V or less		
Surge absorber		Zener Diode		
Response time	Off → On	1ms or less		
	On → Off	1ms or less (Rated load, resistive load)		
Common method		16 point / COM		
Proper cable size		Stranded cable 0.3~0.75mm <sup>2</sup> (external diameter 2.8mm or less)		
Current consumption		60mA (When all outputs are on)		
External power	Voltage	DC12/24V ± 10% (ripple voltage 4 Vp-p or less)		
	Current	10mA or less (connecting DC24V)		
Operation indicator		LED On when output On		
External connection method		8 pin terminal block connector + 10 pin terminal block connector		
Weight		40g		
Circuit configuration				
		No.	Contact	Type
		TB01	0	
		TB02	1	
		TB03	2	
		TB04	3	
		TB05	4	
		TB06	5	
		TB07	6	
		TB08	7	
		TB01	8	
		TB02	9	
		TB03	A	
		TB04	B	
		TB05	C	
		TB06	D	
		TB07	E	
TB08	F			
TB09	COM			
TB10	0V			

## Chapter 3 Input/Output Specifications

## 3.5.9 32 point transistor output module (Source type)



Specification		Model	Transistor output module						
			XBE-TP32A						
Output point		32 point							
Insulation method		Photo coupler insulation							
Rated load voltage		DC 12 / 24V							
Load voltage range		DC 10.2 ~ 26.4V							
Max. load voltage		0.5A / 1 point, 2A / 1COM							
Off leakage current		0.1mA or less							
Max. inrush current		4A / 10 ms or less							
Max. voltage drop (On)		DC 0.4V or less							
Surge absorber		Zener Diode							
Response time	Off → On	1ms or less							
	On → Off	1ms or less (Rated load, resistive load)							
Common method		32 point / COM							
Proper cable size		0.3mm <sup>2</sup>							
Current consumption		120mA (When all outputs are on)							
External power	Voltage	DC12/24V ± 10% (ripple voltage 4 Vp-p or less)							
	Current	20mA or less (connecting DC24V)							
Operation indicator		LED On when output On							
External connection method		40 pin connector							
Weight		60g							
Circuit configuration					No.	Contact	No.	Contact	Type
					B20	00	A20	10	
					B19	01	A19	11	
					B18	02	A18	12	
					B17	03	A17	13	
					B16	04	A16	14	
					B15	05	A15	15	
					B14	06	A14	16	
					B13	07	A13	17	
					B12	08	A12	18	
					B11	09	A11	19	
					B10	0A	A10	1A	
					B09	0B	A09	1B	
					B08	0C	A08	1C	
					B07	0D	A07	1D	
					B06	0E	A06	1E	
					B05	0F	A05	1F	
B04	NC	A04	NC						
B03	NC	A03	NC						
B02	COM	A02	0V						
B01	COM	A01	0V						

## 3.6 Combined Digital I/O module Input Specification

## 3.6.1 8 point DC24V input (Source/Sink type)

Specification		Model	DC input module		
		XBE-DR16A			
Input point		8 point			
Insulation method		Photo coupler insulation			
Rated input voltage		DC24V			
Rated input current		About 4mA			
Operation voltage range		DC20.4~28.8V (within ripple rate 5%)			
On Voltage/Current		DC19V or higher / 3mA or higher			
Off Voltage/Current		DC6V or less / 1mA or less			
Input resistance		About 5.6kΩ			
Response time	Off → On	1/3/5/10/20/70/100ms (set by CPU parameter) Default: 3ms			
	On → Off				
Insulation pressure		AC560Vrms / 3Cycle (altitude 2000m)			
Insulation resistance		10MΩ or more by Megohmmeter			
Common method		8 point / COM			
Proper cable size		Stranded cable 0.3~0.75mm <sup>2</sup> (External diameter 2.8mm or less)			
Current consumption		280mA (When all inputs and outputs are on)			
Operation indicator		LED on when input on			
External connection method		9 pin terminal block connector			
Weight		81g			
Circuit configuration			No.	Contact	Type
			TB1	0	
			TB2	1	
			TB3	2	
			TB4	3	
			TB5	4	
			TB6	5	
			TB7	6	
			TB8	7	
			TB9	COM	

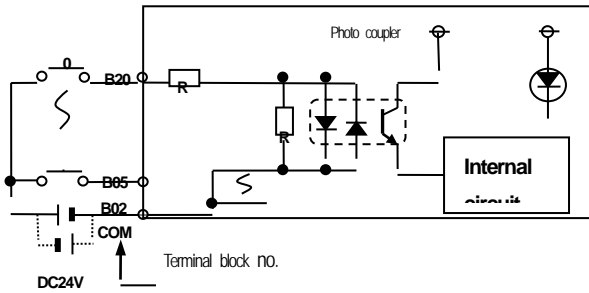
## 3.6.2 16 point DC24V input (Source/Sink type)

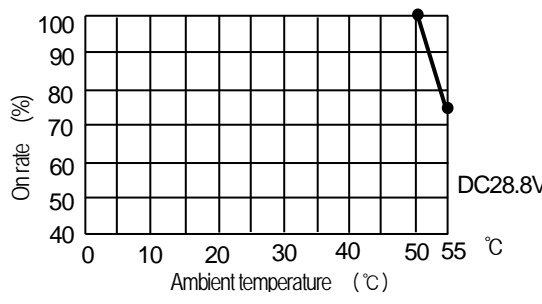
Model		DC input module							
Specification		XBE-DN32A							
Input point		16 point							
Insulation method		Photo coupler insulation							
Rated input voltage		DC24V							
Rated input current		About 4mA							
Operation voltage range		DC20.4~28.8V (ripple rate < 5%)							
Input Derating		Refer to Derating diagram							
On Voltage/Current		DC 19V or higher / 3 mA or higher							
Off Voltage/Current		DC 6V or less / 1 mA or less							
Input resistance		About 5.6kΩ							
Response time	Off → On	1/3/5/10/20/70/100ms (set by CPU parameter) Default:3ms							
	On → Off								
Insulation pressure		AC 560Vrms / 3 Cycle (altitude 2000m)							
Insulation resistance		10MΩ or more by Megohmmeter							
Common method		16 point / COM							
Proper cable size		0.3mm <sup>2</sup>							
Current consumption		60mA (When all inputs and outputs are on)							
Operation indicator		Input On, LED On							
External connection method		40 pin connector							
Weight		60g							
Circuit configuration					No.	Contact	No.	Contact	Type
					B20	00	A20	20	
					B19	01	A19	21	
B18	02	A18	22						
B17	03	A17	23						
B16	04	A16	24						
B15	05	A15	25						
B14	06	A14	26						
B13	07	A13	27						
B12	08	A12	28						
B11	09	A11	29						
B10	0A	A10	2A						
B09	0B	A09	2B						
B08	0C	A08	2C						
B07	0D	A07	2D						
B06	0E	A06	2E						
B05	0F	A05	2F						
B04	NC	A04	P						
B03	NC	A03	P						
B02	IN_COM	A02	OUT_COM						
Input Derating diagram									
									

---

	B01	IN_CO M	A01	OUT_C OM	
--	-----	------------	-----	-------------	--

## 3.7 Combined Digital I/O module Output Specification

## 3.7.1 8 point relay output

Model		Relay output module		
Specification		XBE-DR16A		
Output point		8 point		
Insulation method		Relay insulation		
Rated load voltage / Current		DC24V 2A (Resistive load) / AC220V 2A (COS $\Psi$ = 1), 5A/COM		
Min. load voltage/Current		DC5V / 1mA		
Max. load voltage		AC250V, DC125V		
Off leakage current		0.1mA (AC220V, 60Hz)		
Max. On/Off frequency		3,600 times/hr		
Surge absorber		None		
Service life	Mechanical	20 millions times or more		
	Electrical	Rated load voltage / current 100,000 times or more		
		AC200V / 1.5A, AC240V / 1A (COS $\Psi$ = 0.7) 100,000 times or more		
		AC200V / 1A, AC240V / 0.5A (COS $\Psi$ = 0.35) 100,000 times or more		
Response time	Off $\rightarrow$ On	10ms or less		
	On $\rightarrow$ Off	12ms or less		
Common method		8 point / COM		
Proper cable size		Stranded cable 0.3~0.75mm <sup>2</sup> (external diameter 2.8mm or less)		
Current consumption		280mA (When all inputs and outputs are on)		
Operation indicator		LED on when output on		
External connection method		9 pin terminal block connector		
Weight		81g		
Circuit configuration				
		No.	Contact	Type
		TB1	0	
		TB2	1	
		TB3	2	
		TB4	3	
		TB5	4	
		TB6	5	
		TB7	6	
		TB8	7	
		TB9	COM	

## 3.7.2 16 point transistor output(Sink type)

Model		Transistor output module				
Specification		XBE-DN32A				
Output point		8 point				
Insulation method		Photo coupler insulation				
Rated voltage		DC12/24V				
Rated current		About 4mA				
Operation voltage range		DC10.2~26.4V				
Max. load voltage		0.2A / 1 point, 2A / 1COM				
Off leakage current		0.1mA or less				
Max. load voltage		0.7A / 10ms or less				
Max. voltage drop (On)		DC 0.4V or less				
Surge absorber		TVS Diode				
Response time	Off → On	1ms or less				
	On → Off	1ms or less (Rated load, resistive load)				
Common method		32 point / COM				
Proper cable size		0.3mm <sup>2</sup>				
Current consumption		60mA (when all point On)				
External power	Voltage	DC12/24V ± 10% (ripple voltage 4 Vp-p or less)				
	Current	20mA or less (connecting DC24V)				
Operation indicator		LED On when output On				
External connection method		40 pin terminal block connector				
Weight		60g				
Circuit configuration		No.	Contact		Type	
		B20	00	A20	20	
		B19	01	A19	21	
		B18	02	A18	22	
		B17	03	A17	23	
		B16	04	A16	24	
		B15	05	A15	25	
		B14	06	A14	26	
		B13	07	A13	27	
		B12	08	A12	28	
		B11	09	A11	29	
		B10	0A	A10	2A	
		B09	0B	A09	2B	
		B08	0C	A08	2C	
		B07	0D	A07	2D	
		B06	0E	A06	2E	
		B05	0F	A05	2F	
B04	NC	A04	P			
B03	NC	A03	P			
B02	IN_COM	A02	OUT_COM			
B01		A01				

## 3.8 I/O modules' Functions

### 3.8.1 Input filter function

The XGB PLC's input modules have the input filter function to prevent the external noise signal flowed into the input signal. For more details on the input filter function, refer to the below.

#### (1) Purposes and Operations of the input filter function

Under the environment with serious noise or in the case of the equipment that is greatly affected by the input signal's pulse width, the system may receive incorrect input depending on the input signal status. To prevent such incorrect input, the input filter function does not regard the signal that is shorter than the set time by a user as input. In the case of the XGB PLC, you can set the input filter time in the range of 1ms~100ms.

The below timing chart represents the operations of the input filter function.

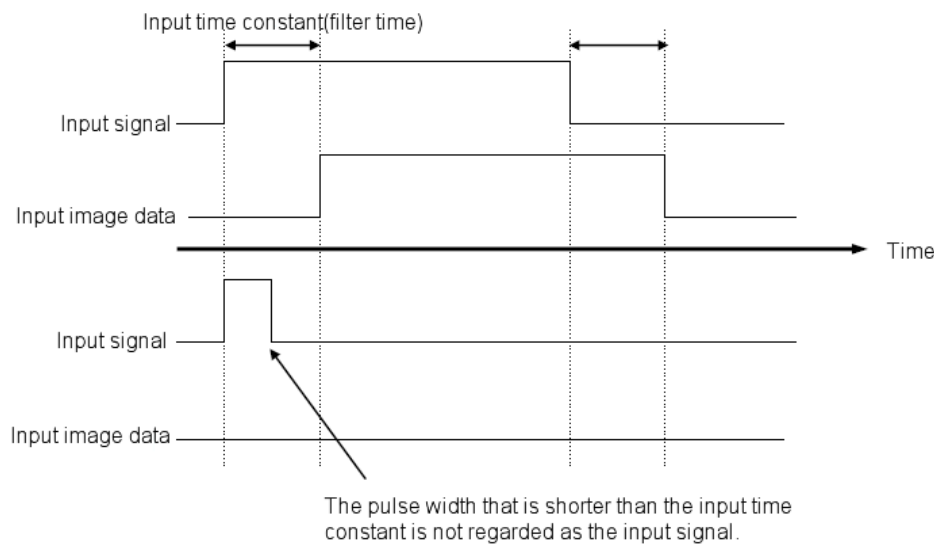

### 3.8.2 Emergency output function

The XGB PLC's output module supports the emergency output function to determine whether maintaining the output status of the output module or clearing it when the PLC is stopped due to errors.

You can set the emergency output by 8 points. For more details on how to set the emergency output, refer to the below.

### 3.8.3 Pulse Catch Function

The XGB PLC basic unit has the input contacts (P0008 ~ P000F) for Pulse Catch with 8 points. Through these contacts, it is possible to receive the very short pulse signal that cannot be recognized by the normal digital input.

#### (1) Purposes and Operations of the Pulse Catch function

The PLC's input data is refreshed in a lump once every scan. Accordingly, the very short pulse signal that is input during scan and is off before the scan is finished cannot be recognized as input. If you need to recognize and process such short pulse signal, you can use the Pulse Catch function. If you apply this function, the short pulse of the minimum of 50 $\mu$ s can be recognized.



The below timing chart represents the operations of the Pulse Catch function.

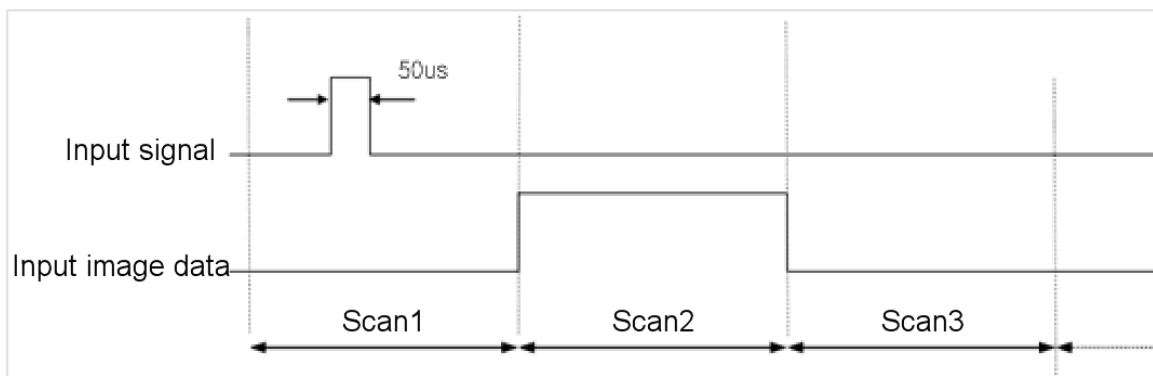

Step	Processing details
Scan 1	When the minimum pulse signal of 50 $\mu$ s is input, the CPU part will detect the fact and save the status.
Scan 2	The input image data area is On.
Scan 3	The input image data area is Off.

## Chapter 3 Input/Output Specifications

### 3.8.4 Smart link board

Easy wiring is available by connecting the IO connector with smart link board.  
The available smart link and IO cable are as follows.

XGB		Smart link		Connection cable		
Item	Model	Model	Pin	Model	Length	Contents
Main unit	XBM-DN32H	XTB-40H (TG7-1H40S)	40	C40HH-05SB-XBI C40HH-10SB-XBI	0.5~ 1m	For main unit connection (40Pin)
Expansion module	XBE-DC32A	XTB-40H (TG7-1H40S)	40	C40HH-10SB-XBE	1m	For expansion module connection (40Pin)
	XBE-TN32A	XTB-40H (TG7-1H40S)	40	C40HH-10SB-XBE	1m	
		R32C-NS5A-4 0P	40	C40HH-10SB-XBE	1m	For expansion module connection (40Pin) Exclusive for relay built-in type

It describes wiring of XGB, XTB-40H and C40HH-10SB-XBI.

For wiring of other smart link boards or XGB extension module, refer to XGB user manual for hardware.

#### 1) XTB-40H terminal array

Terminal array of XTB-40H is as follows.

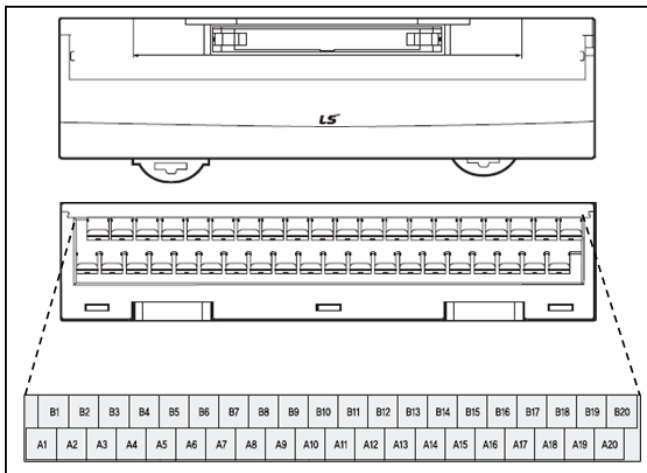

Item	Specification	
Rated voltage	AC/DC 125[V]	
Rated current	Max. 1[A]	
Withstanding voltage	500V 1min	
Insulation resistor	100MΩ (DC500V)	
Cable specification	AWG22-16 (1.5mm <sup>2</sup> / MAX)	
Terminal/screw	M3 X 8L	
Torque	1.2N · m (12kgf · cm)	
material	Terminal	Modifide PP0
	Cover	Polycarbonate
	PCB	Epoxy 1.6t

## 2) Wiring of XTB-40H and XGB extension module

Wiring of XGB main unit through XTB-40H and C40HH-10SB-XBI is as follows.



At this time, relationship of XGB IO signal and Smart link board terminal number is as follows. The following figure describes signal allocation when C40HH-10SB-XBI is used as connection cable. When the user makes the cable, make sure that wiring is done as figure below.

	B1	B2	B3	B4	B5	B6	B7	B8	B9	B10	B11	B12	B13	B14	B15	B16	B17	B18	B19	B20
A1	A2	A3	A4	A5	A6	A7	A8	A9	A10	A11	A12	A13	A14	A15	A16	A17	A18	A19	A20	

Signal

	P001	P003	P005	P007	P009	P00B	P00D	P00F	NC	COM	P021	P023	P025	P027	P029	P02B	P02D	P02F	12/24V	COM
P000	P002	P004	P006	P008	P00A	P00C	P00E	NC	COM	P020	P022	P024	P026	P028	P02A	P02C	P02E	12/24V	COM	
Input										Output										

## Chapter 4 Built-in High-speed Counter Function

XGB (XBM 'H') series have built-in function of High-speed counter in basic unit. This chapter describes specifications and usage of High-speed counter's function.

### 4.1 High-speed Counter Specifications

#### 4.1.1 Performance specifications

(1) Performance specification

Classification		Description	
Count input signal	Signal	A-phase, B-phase	
	Input type	Voltage input (Open collector)	
	Signal level	24V	
Max. coefficient speed		100 kpps	
Number of channels	1 phase	100kpps 4 channels	
	2 phase	20kpps 4 channels)	
Coefficient range		Signed 32 Bit (-2,147,483,648 ~ 2,147,483,647)	
Count mode (Program setting)		Linear count (if 32-bit range exceeded, Carry/Borrow occurs) Counter max. and min. value is indicated	
		Ring count (repeated count within setting range)	
Input mode (Program setting)		1-phase input	
		2-phase input	
		CW/CCW input	
Signal type		Voltage	
Up/Down setting	1 phase input	Increasing/decreasing operation setting by B-phase input	
		Increasing/decreasing operation setting by program	
	2 phase input	Automatic setting by difference in phase	
		A-phase input: increasing operation B-phase input: decreasing operation	
Multiplication function	1 phase input	1 multiplication	
	2 phase input	4 multiplication	
	CW/CCW	1 multiplication	
Control input	Signal	Preset instruction input	
	Signal level	DC 24V input type	
	Signal type	Voltage	
External output	Output points	1 point/channel (for each channel) :output contact point of basic unit available	2 point/channel (for each channel) :output contact point of basic unit available
		Select single-compared (>, >=, =, =<, <) or section compared output (included or excluded) (program setting)	
	Output type	Relay, Open-collector output (Sink)	
Count Enable		To be set through program (count available only in enable status)	
Preset function		To be set through terminal (contact) or program	
Auxiliary mode		Count Latch	

## (2) Counter/Preset input specification

Classification	Spcification
Input voltage	24V DC (20.4V ~ 28.8V)
Input current	4mA
On guranteed voltage (min.)	20.4V
Off guranteed voltage (max.)	6V

## 4.1.2 Designation of parts

## (1) Designation of parts

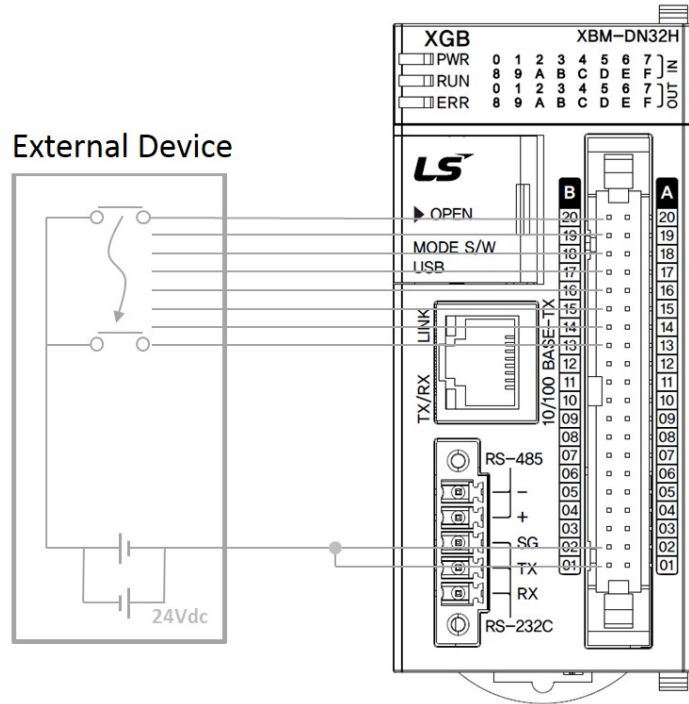

Terminal No.	Names		Usage	
	1-phase	2-phase	1-phase	2-phase
B20	Ch0 counter input	Ch0 A-phase input	Counter input terminal	A-phase input
B19	Ch1 counter input	Ch0 B-phase input	Counter input terminal	B-phase input
B18	Ch2 counter input	Ch2 A-phase input	Counter input terminal	A-phase input
B17	Ch3 counter input	Ch2 B-phase input	Counter input terminal	B-phase input
B16	Ch0 preset 24V	Ch0 preset 24V	Preset input terminal	Preset input terminal
B15	Ch1 preset 24V	-	Preset input terminal	No use
B14	Ch2 preset 24V	Ch2 preset 24V	Preset input terminal	Preset input terminal
B13	Ch3 preset 24V	-	Preset input terminal	No use
B12				
B11				
B10				
B09				
B08				
B07				
B06				
B05				
B04				
B03				
B02	Input common	Input common	Common terminal	Common terminal
B01	Input common	Input common	Common terminal	Common terminal

## (2) Interface with external devices

The internal circuit of High-speed counter is as shown below.

I/O	Internal circuit	Terminal No.	Signal		Operation	On/Off guaranteed voltage
			1-phase	2-phase		
Input		B20	Ch 0 Pulse input	Ch 0 A-phase input	On	20.4~28.8V
					Off	6V or less
		B19	Ch 1 Pulse input	Ch 0 B-phase input	On	20.4~28.8V
					Off	6V or less
		B18	Ch 2 Pulse input	Ch 2 A-phase input	On	20.4~28.8V
					Off	6V or less
		B17	Ch 3 Pulse input	Ch 2 B-phase input	On	20.4~28.8V
					Off	6V or less
		B16	Ch 0 Preset input	Ch 0 Preset input	On	20.4~28.8V
					Off	6V or less
		B15	Ch 1 Preset input	-	On	20.4~28.8V
					Off	6V or less
		B14	Ch 2 Preset input	Ch 2 Preset input	On	20.4~28.8V
					Off	6V or less
		B13	Ch 2 Preset input	-	On	20.4~28.8V
					Off	6V or less
		B01/B02	COM (input common)			

### 4.1.3 High speed counter Functions

#### (1) Counter mode

A) High Speed counter module can count High Speed pulses which can not be processed by CPU module's counter instructions (CTU, CTD, CTUD, etc.), up to binary value of 32 bits (-2,147,483,648 ~ 2,147,483,647).

B) Available input is 1-phase input, 2-phase input and CW/ CCW input.

C) Count increasing/decreasing methods are as follows;

(1) For 1-phase input: (1) Increasing/decreasing count operation by program setting

(2) Increasing/decreasing count operation by B-phase input signal

(2) For 2-phase input: setting by difference in phase between A-phase and B-phase

(3) For CW/CCW input: Increasing operation if B-phase is LOW with A-phase input, and Decreasing operation if A-phase is LOW with B-phase input.

D) Auxiliary modes are as follows;

- Count Latch
- Periodic Pulse Count
- Frequency measure function
- Count prohibited function

#### E) Pulse input mode

(1) Increasing/decreasing count operation by program setting

a) 1-phase 1-input 1-multiplication operation mode

A-phase input pulse counts at rising and increasing/decreasing will be decided by the applicable program.

Increasing/Decreasing classification	A-phase input pulse rising	A-phase input pulse falling
Increasing/decreasing count setting signal Off	Increasing count	-
Increasing/decreasing count setting signal On	Decreasing count	-

#### • Operation example

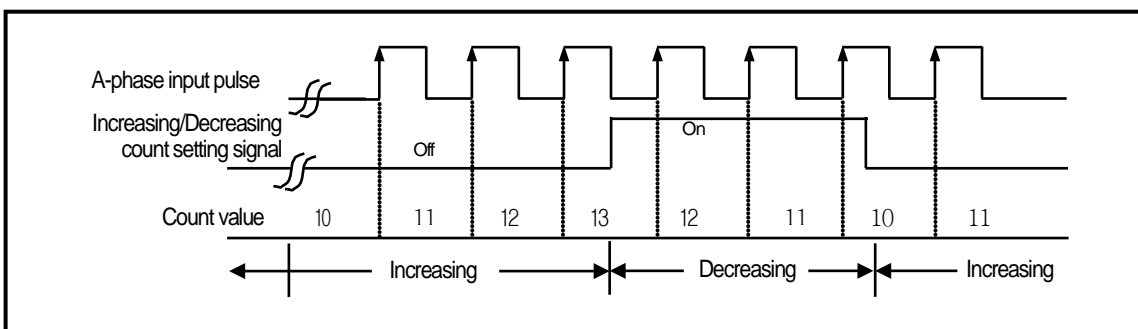



## (2) Increasing/decreasing count operation by B-phase input signal

## 1) 1-phase 2-input 1-multiplication operation mode

A-phase input pulse counts at rising and increasing/decreasing will be decided by B-phase.

Increasing/Decreasing classification	A-phase input pulse rising	A-phase input pulse falling
B-phase input pulse Off	Increasing count	-
B-phase input pulse On	Decreasing count	-

## • Operation example

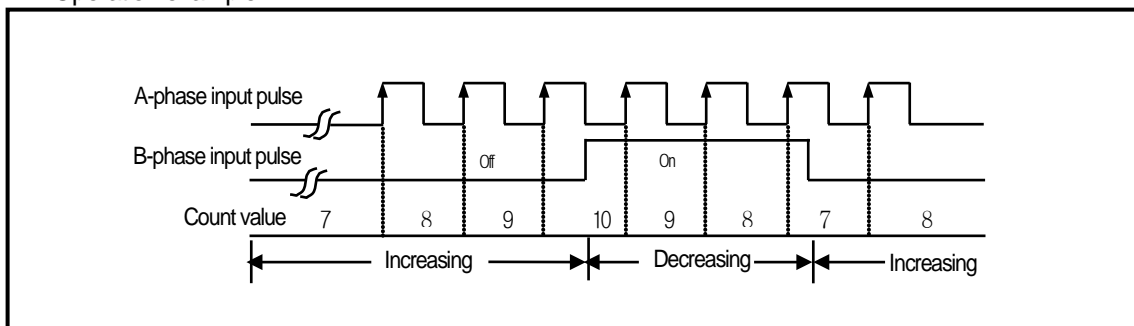

## 2) 2-phase count mode

## a) 2-phase 4-multiplication operation mode

A-phase input pulse and B-phase input pulse count at rising/falling respectively. If A-phase input is antecedent to B-phase input, increasing operation starts, and if B-phase input is antecedent to A-phase input, decreasing operation starts.

## • Operation example

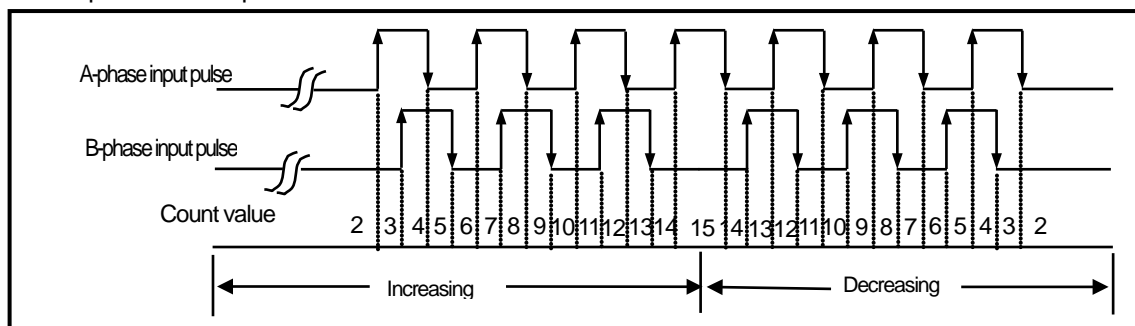

## Chapter 4 Built-in High-speed Counter Function

### 3) CW(Clockwise)/CCW(Counter Clockwise) operation mode

A-phase input pulse counts at rising , or B-phase input pulse counts at rising.

Increasing operation executed when B-phase input pulse is Low with A-phase input pulse at rising, and Decreasing operation executed when A-phase input pulse is Low with B-phase input pulse at rising.

Increasing/Decreasing classification	A-phase input pulse High	A-phase input pulse Low
B-phase input pulse High	-	decreasing count
B-phase input pulse Low	Increasing count	-

#### ▪ Operation example

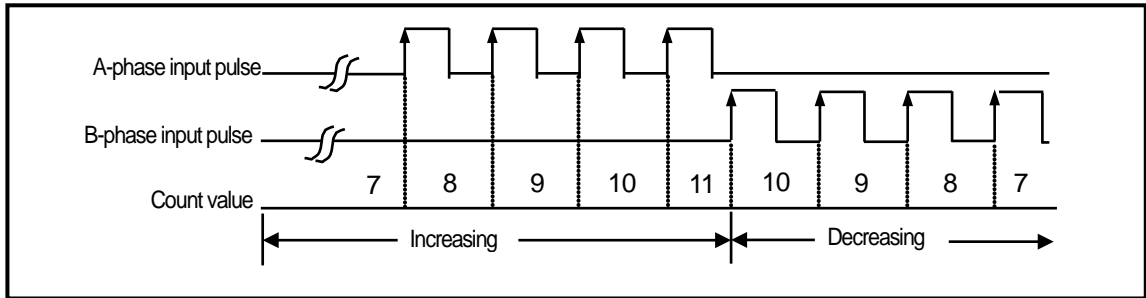

### (2) Counter type

2 types of count (Linear counter, Ring counter) can be selected for the applicable use based on functions.

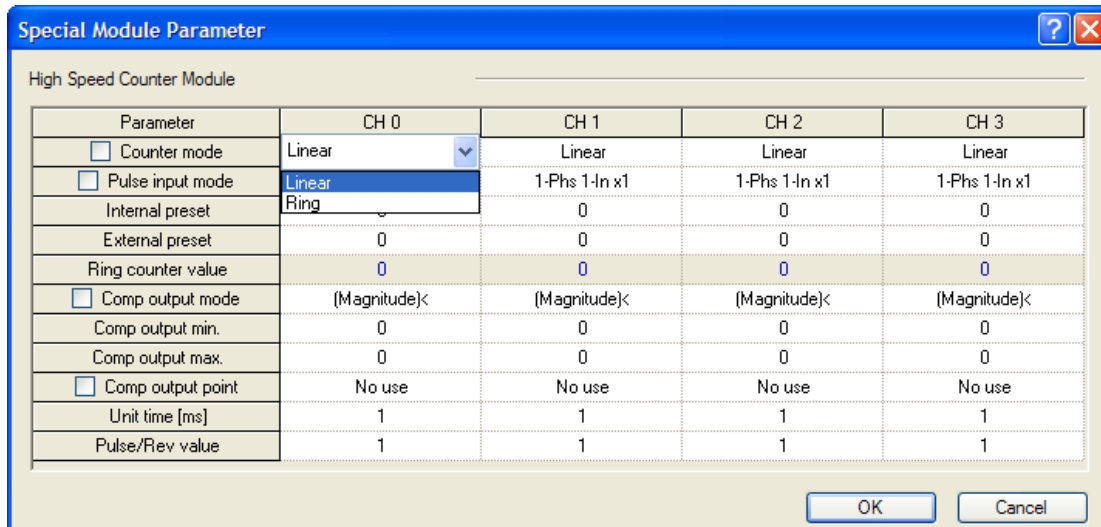

▪ Counter mode is saved at the following special K area.

Mode	Area per each channel (word)				Reference*1)
	Ch.0	Ch.1	Ch.2	Ch.3	
Counter mode	K300	K330	K360	K390	0 : linear 1 : ring

\*1) If counter mode is set as value other than 0, 1, error code '20' will occur.

2 types of count can be selected for the applicable use based on functions.

#### A) Linear counter

- Linear Count range: -2,147,483,648 ~ 2,147,483,647
- If count value reaches the maximum value while increased, Carry will occur, and if count value reaches the minimum value while decreased, Borrow will occur.
- If Carry occurs, count stops and increasing is not available but decreasing is available.
- If Borrow occurs, count stops and decreasing is not available but increasing is available.

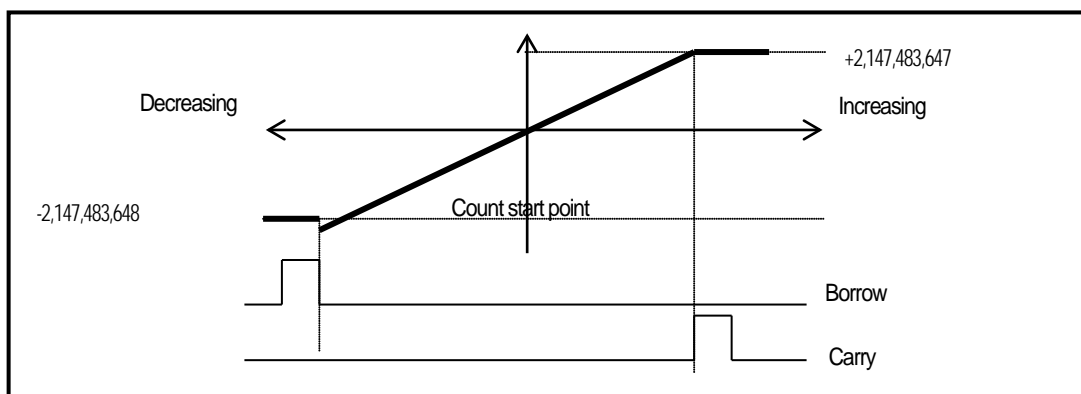

#### B) Ring count

- Ring Count range: user-defined minimum value ~ user-defined maximum value
- Count display: If Ring Counted, user-defined minimum value of Ring Count is counted and displayed, but the value is not displayed.

Special Module Parameter				
High Speed Counter Module				
Parameter	CH 0	CH 1	CH 2	CH 3
<input type="checkbox"/> Counter mode	Ring	Linear	Linear	Linear
<input type="checkbox"/> Pulse input mode	1-Phs 1-In x1	1-Phs 1-In x1	1-Phs 1-In x1	1-Phs 1-In x1
Internal preset	0	0	0	0
External preset	0	0	0	0
Ring counter value	1000	0	0	0
<input type="checkbox"/> Comp output mode	(Magnitude)<	(Magnitude)<	(Magnitude)<	(Magnitude)<
Comp output min.	0	0	0	0
Comp output max.	0	0	0	0
<input type="checkbox"/> Comp output point	No use	No use	No use	No use
Unit time [ms]	1	1	1	1
Pulse/Rev value	1	1	1	1

1~60000

OK Cancel

- Ring counter value is saved at the following special K area.

type	Area per each channel (Double word)				Reference
	Ch.0	Ch.1	Ch.2	Ch.3	
Ring counter value	K310	K340	K270	K400	

## Chapter 4 Built-in High-speed Counter Function

### 1) During increasing count

- Even if count value exceeds user-defined maximum value during increasing count, Carry only occurs and count does not stop differently to Linear Count.

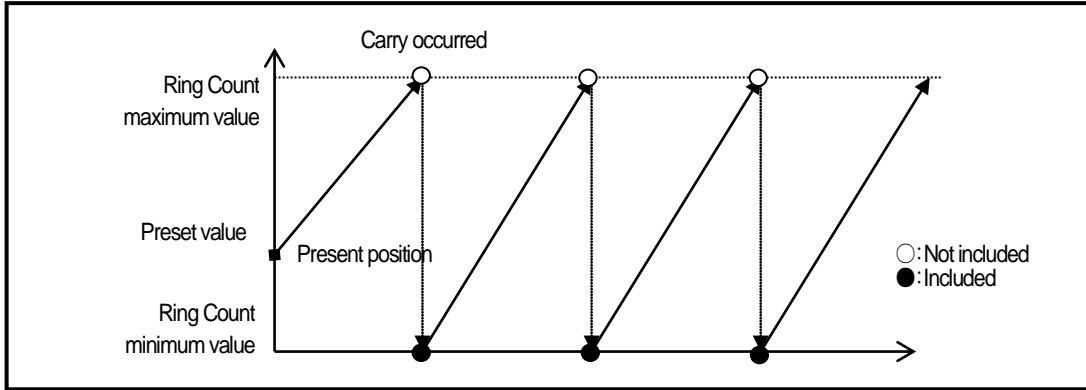

### 2) During decreasing count

- Even if count value exceeds user-defined minimum value during decreasing count, Borrow only occurs and count does not stop differently to Linear Count.

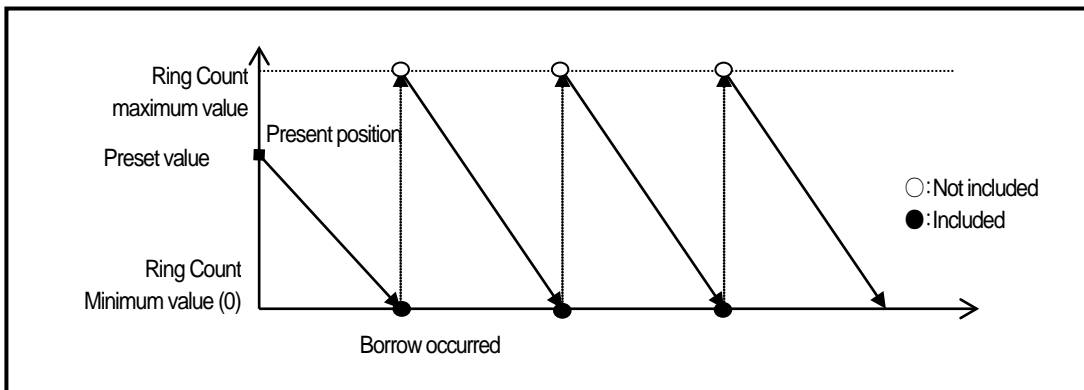

## 3) Operation when setting the ring count according to the current count value (at the count of addition)

- When setting the ring count, the current count value is below the minimum value of the ring counter.
  - Opens an error (Code No. 27), operates as a linear counter, and operates as a ring count when the current count value falls within the range of the ring count (error codes are not cleared).
- When setting the ring count, the current count value is above the maximum value of the ring counter.
  - Displays an error (Code No. 27), operates as a linear counter, and stops counting when the current count value reaches the maximum count value (error code is not cleared).
- When setting the ring count, the current count value is within the user setting range
  - It starts to increase from the current count value, increases to the maximum value set by the user, then becomes the minimum value set by the user and continues to count after carrying a carry.
  - As shown in the figure below, the maximum value is not displayed and the count continues after displaying the minimum value.

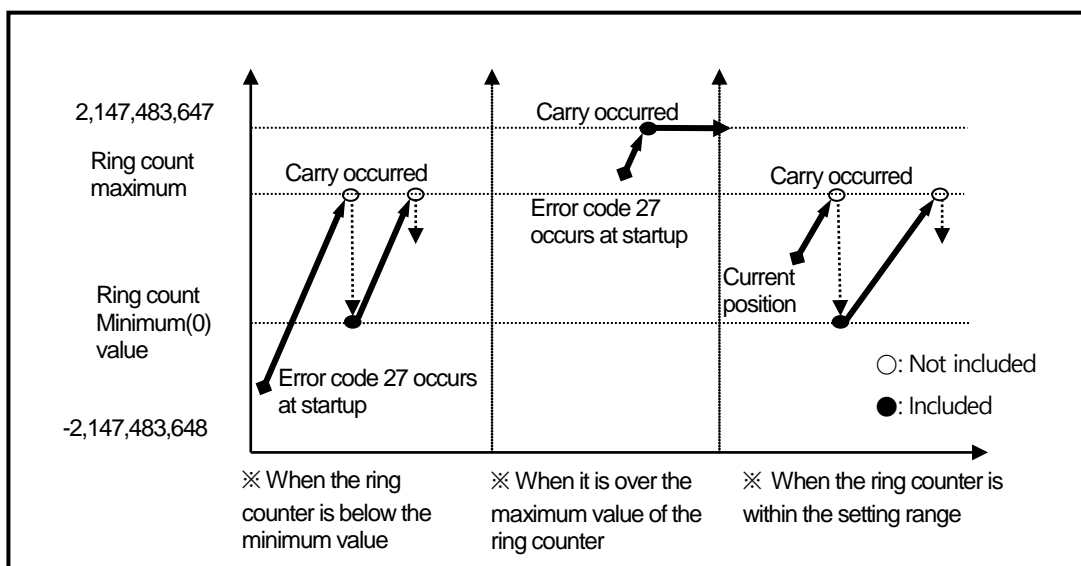

- 4) Operation when setting the ring count according to the current count value (when subtracting count)
- When setting the ring count, the current count value is below the minimum value of the ring counter.
    - When an error (Code No. 27) is displayed, it operates as a linear counter, and if the current count value falls within the range of the ring count, it operates as a ring counter. (The error code is not cleared)
  - When setting the ring count, the current count value is above the maximum value of the link counter.
    - An error (Code No. 27) is displayed, and it operates as a linear counter, but stops counting when the current count value reaches the count minimum value. (The error code is not cleared)
  - When setting the ring count, the current count value is within the user setting range
    - It starts to decrease from the current count value, decreases to the minimum value set by the user, and becomes the maximum value set by the user, and then continues counting after Borrow occurs.

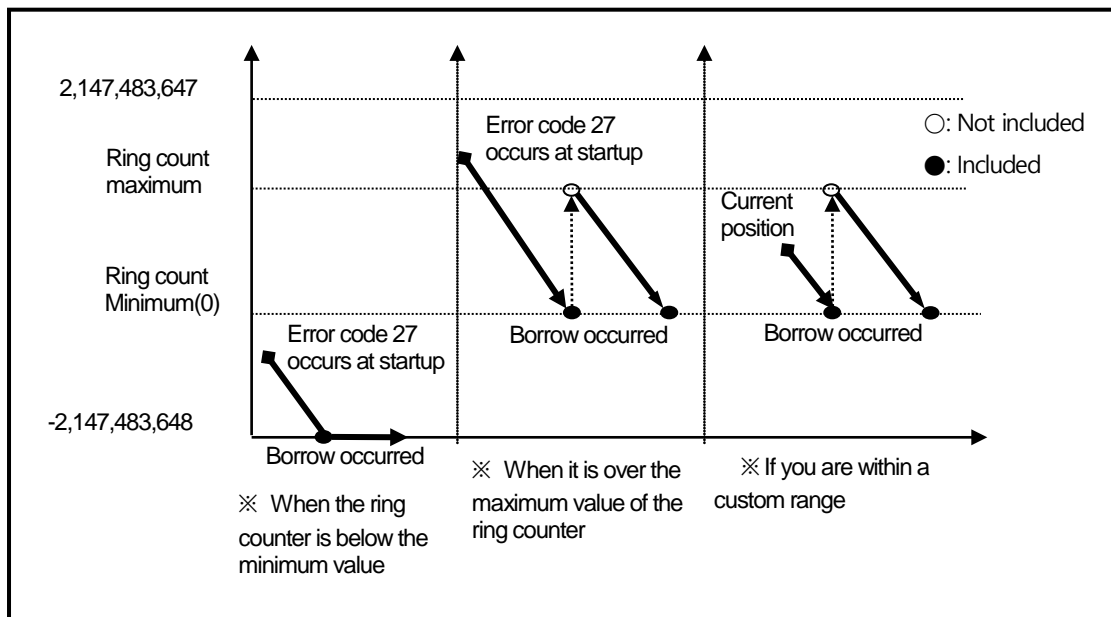

#### Remark

(1) When using a ring count, be sure to place the count value within the range using a preset or the like.

## (3) Compared output

- (a) High Speed counter module has a compared output function used to compare present count value with compared value in size to output as compared.
- (b) Available compared outputs are 2 for 1 channel, which can be used separately.
- (c) Compared output conditions are 7 associated with  $>$ ,  $=$ ,  $<$ .
- (d) Parameter setting
- Compared output mode setting

Parameter	CH 0	CH 1	CH 2	CH 3
<input type="checkbox"/> Counter mode	Ring	Linear	Linear	Linear
<input type="checkbox"/> Pulse input mode	1-Phs 1-In x1	1-Phs 1-In x1	1-Phs 1-In x1	1-Phs 1-In x1
Internal preset	0	0	0	0
External preset	0	0	0	0
Ring counter value	1000	0	0	0
<input type="checkbox"/> Comp output mode	(Magnitude)<	(Magnitude)<	(Magnitude)<	(Magnitude)<
Comp output min.	(Magnitude)<	0	0	0
Comp output max.	(Magnitude)<=	0	0	0
<input type="checkbox"/> Comp output point	(Magnitude)=	No use	No use	No use
Unit time [ms]	(Magnitude)>=	1	1	1
Pulse/Rev value	(Range)Include	1	1	1
	(Range)Exclude			

- Upper setting value is saved in special K area.

Compared output condition	Memory address (word)	Value <sup>*2)</sup>
Present Value < Compared Value	Channel 0 : K302 Channel 1 : K330 Channel 2 : K358 Channel 3 : K386	Set to "0"
Present Value ≤ Compared Value		Set to "1"
Present Value = Compared Value		Set to "2"
Present Value ≥ Compared Value		Set to "3"
Present Value > Compared Value		Set to "4"
Compared value 1 ≤ Count value ≤ Compared value 2		Set to "5"
Count value ≤ Compared value 1, Count value ≥ Compared value 2		Set to "6"

\*2) If compared output value not set to 0-6 using counter, error code '23' will be occurred.

- In order to make actual comparison enabled after compared output condition set, the compared enable signal is to be On.

Classification	Area per channel				Operation
	Ch. 0	Ch. 1	Ch. 2	Ch. 3	
Count enable signal	K2600	K2700	K2800	K2900	0: N/A, 1: enable
Compared enable signal	K2604	K2704	K2804	K2904	0: forbidden, 1: enable

## Chapter 4 Built-in High-speed Counter Function

- In order to make external output, the compared equivalent output signal (P20~P27) must be set. If Compared output contact is Off, Compared coincidence output signal (internal device) is only output.

Classification	Area per channel				Operation
	Ch. 0	Ch. 1	Ch. 2	Ch. 3	
Compared equivalent output signal	K2612	K2712	K2812	K2912	0: Compared output not equivalent 1: Compared output equivalent

- Comp output point (P20 ~ P27) setting

Special Module Parameter

High Speed Counter Module

Parameter	CH 0	CH 1	CH 2	CH 3
<input type="checkbox"/> Counter mode	Ring	Linear	Linear	Linear
<input type="checkbox"/> Pulse input mode	1-Phs 1-In x1	1-Phs 1-In x1	1-Phs 1-In x1	1-Phs 1-In x1
Internal preset	0	0	0	0
External preset	0	0	0	0
Ring counter value	1000	0	0	0
<input type="checkbox"/> Comp output mode	(Magnitude)<	(Magnitude)<	(Magnitude)<	(Magnitude)<
Comp output min.	0	0	0	0
Comp output max.	0	0	0	0
<input type="checkbox"/> Comp output point	No use	No use	No use	No use
Unit time [ms]	No use	1	1	1
Pulse/Rev value	P20	1	1	1
	P21			
	P22			
	P23			
	P24			

OK Cancel



## (e) Detailed description for compared output

## A) Mode 0 (Present value &lt; Compared value)

- If counted present value is less than compared value, output is sent out, and if present value increases to be equal to or greater than compared value, output is not sent out.

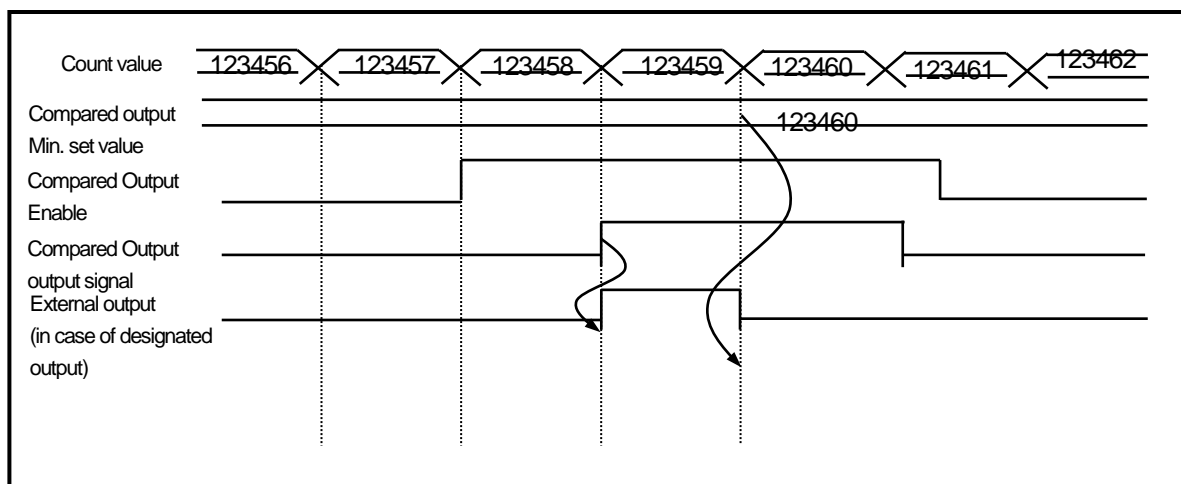

## B) Mode1 (Count value ≤ Compared value)

- If present count value is less than or equal to compared value, output is sent out, and if count value increases to be greater than compared value, output is not sent out.

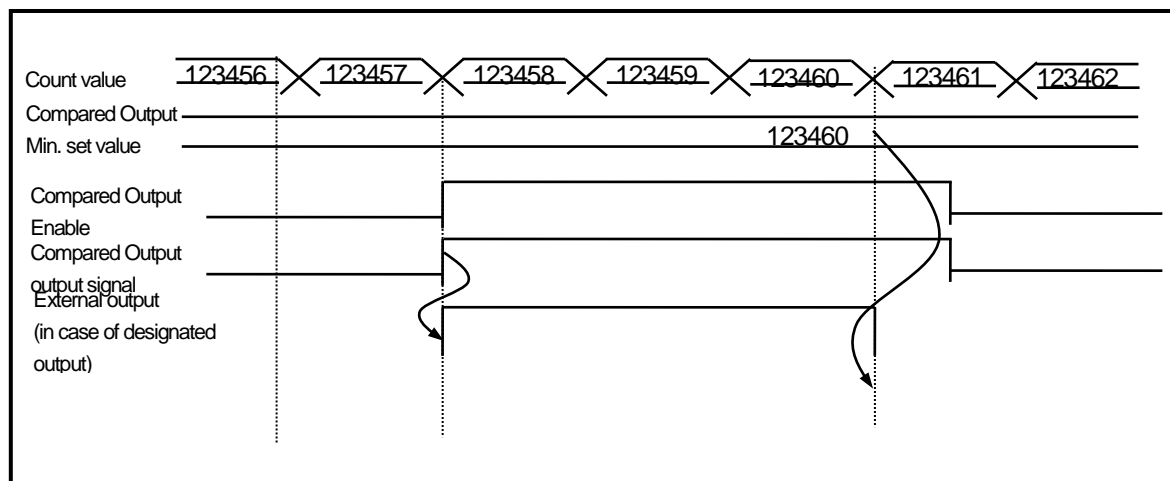

## Chapter 4 Built-in High-speed Counter Function

### C) Mode 2 (Count value = Compared value)

- If present count value is equal to compared value, output is sent out. In order to turn the output Off, Compared output Enable and Compared output signal is to be On.

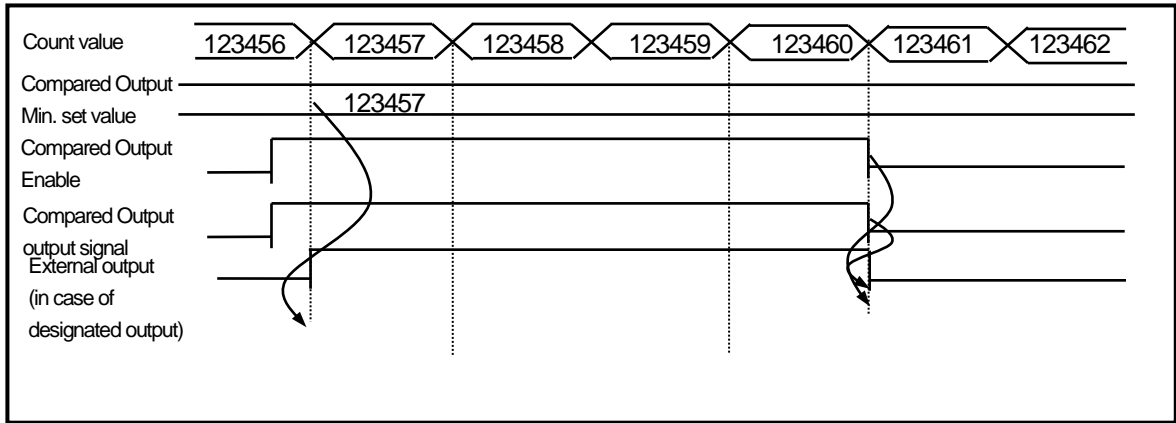

### D) Mode 3 (Count value $\geq$ Compared value)

- If present count value is greater than or equal to compared value, output is sent out, and if count value decreases to be less than compared value, output is not sent out.

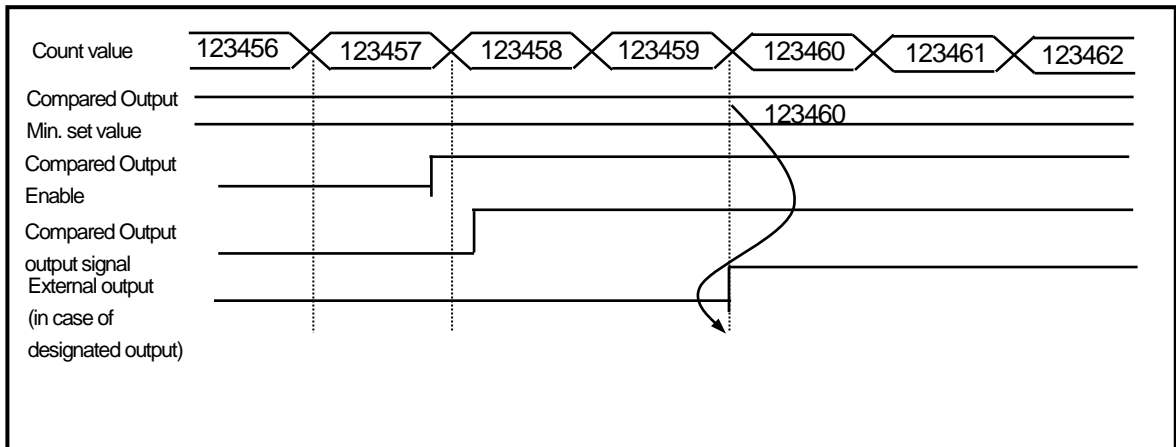

## E) Mode 4 (Count value &gt; Compared value)

- If present count value is greater than compared value, output is sent out, and if count value decreases to be less than or equal to compared value, output is not sent out.

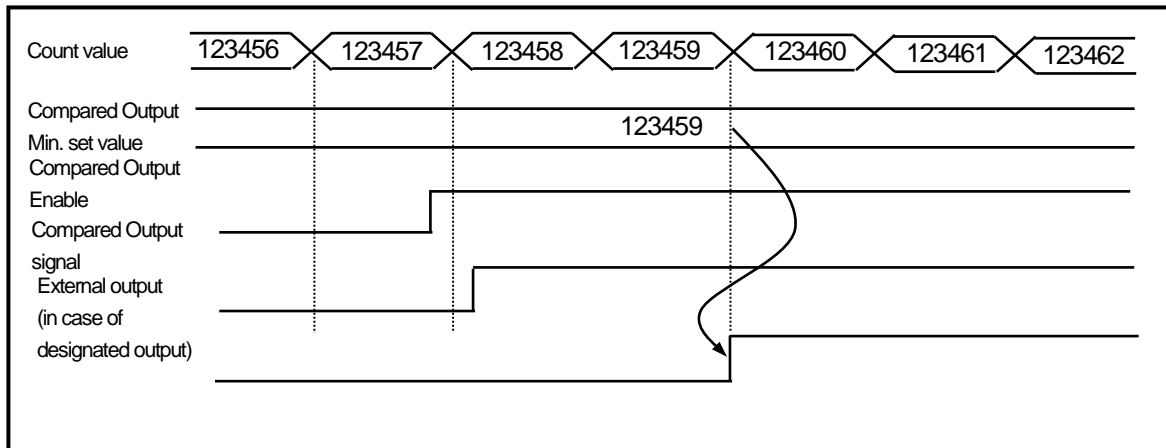

## F) Mode 5

(Compared output Min. set value ≤ Count value ≤ Compared output Max. set value)

- If present count value is greater than or equal to compared output Min. value and less than or equal to compared output Max. set value, output is sent out, and if count value increases/decreases to exceed compared value's range, output is not sent out.

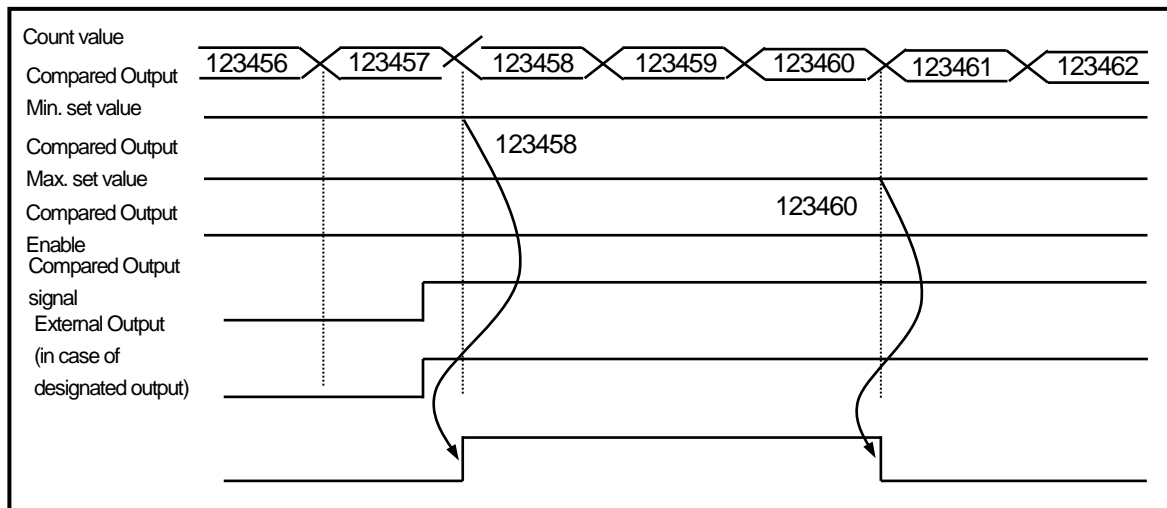

## Chapter 4 Built-in High-speed Counter Function

G) Mode 6 (Count value  $\leq$  Compared output Min. value, Count value  $\geq$  Compared output Max. value)

- If present count value is less than or equal to compared output Min. value and greater than or equal to compared output Max. value, output is sent out, and if count value increases/decreases to exceed compared value's range, output is not sent out.

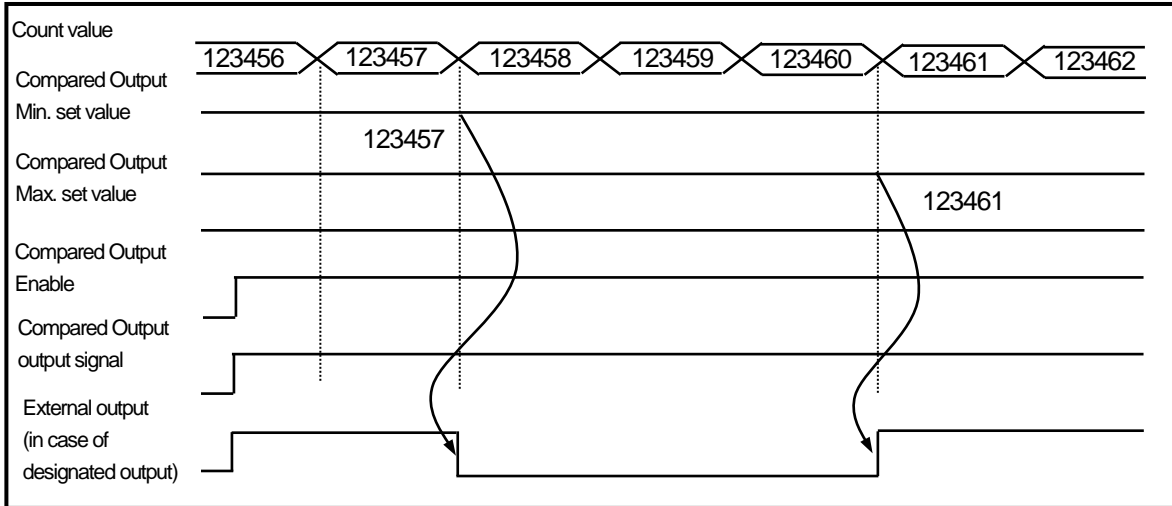

## (4) Carry signal

## A) Carry signal occurs

- (1) When count range maximum value of 2,147,483,647 is reached during Linear Count.
- (2) When user-defined maximum value of Ring Count changed to the minimum value during Ring Count.

## B) Count when Carry Signal occurs

- (1) Count stops if Carry occurs during Linear Count.
- (2) Count does not stop even if Carry occurs during Ring Count.

## C) Carry reset

- (1) The Carry generated can be cancelled by Carry/Borrow reset signal On.

Classification	Device area per channel			
	Channel 0	Channel 1	Channel 2	Channel 3
Carry signal	K2610	K2710	K2810	K2910

## (5) Borrow signal

## A) Borrow signal occurs

- (1) When count range minimum value of -2,147,483,648 is reached during Linear Count.
- (2) When user-defined minimum value of Ring Count changed to the maximum value during Ring Count.

## B) Count when Borrow signal occurs

- (1) Count stops if Borrow occurs during Linear Count.
- (2) Count does not stop even if Borrow occurs during Ring Count.

## C) Borrow reset

- (1) The Borrow generated can be cancelled by Carry/Borrow reset signal On..

Classification	Device area per channel			
	Channel 0	Channel 1	Channel 2	Channel 3
Borrow signal	K2611	K2711	K2811	K2911

## Chapter 4 Built-in High-speed Counter Function

### (6) Revolution/Unit time

While auxiliary mode enable signal is On, it counts the number of input pulses for a specified time.

#### A) Setting

##### (1) Unit time setting

##### 1) Input unit time and pulse number per 1 revolution

Parameter	CH 0	CH 1	CH 2	CH 3
<input type="checkbox"/> Counter mode	Linear	Linear	Linear	Linear
<input type="checkbox"/> Pulse input mode	1-Phs 1-In x1	1-Phs 1-In x1	1-Phs 1-In x1	1-Phs 1-In x1
Internal preset	0	0	0	0
External preset	0	0	0	0
Ring counter value	0	0	0	0
<input type="checkbox"/> Comp output mode	(Magnitude)<	(Magnitude)<	(Magnitude)<	(Magnitude)<
Comp output min.	0	0	0	0
Comp output max.	0	0	0	0
<input type="checkbox"/> Comp output point	No use	No use	No use	No use
Unit time [ms]	1000	1	1	1
Pulse/Rev value	1	1	1	1

1~60000

OK Cancel

Setting value is saved at the following special K are and user can designate it directly.

Classification	Device area per channel			
	Channel 0	Channel 1	Channel 2	Channel 3
Unit time (1~60000ms) <sup>*3)</sup>	K322	K352	K382	K412

<sup>\*3)</sup> If revolution per unit time is enabled and unit time value is other than 1~60000ms, error code '34' occurs.

##### 2) Input pulse number per 1 revolution

Classification	Device area per channel			
	Channel 0	Channel 1	Channel 2	Channel 3
Pulse number /revolution (1~60000) <sup>*4)</sup>	K323	K353	K383	K413

<sup>\*4)</sup> If revolution per unit time is enabled and pulse number/revolution is other than 1~60000, error code '35' occurs.

##### 3) If Count function of revolution per unit time is used, enable signal set by On.

Classification	Device area per channel			
	Channel 0	Channel 1	Channel 2	Channel 3
Revolution/unit time command	K2605	K2705	K2805	K2905

B) Count function of Revolution per Unit time is used to count the number of pulses for a specified time while Enable signal is On.

C) With the displayed number of pulses updated for a specified time and the number of pulses per revolution input, Revolution/Unit time can be counted.

D) Number of Revolution per 1 second is indicated after number of pulse per 1 revolution is set and time is set to 1 second (1000ms). In order to indicate by Revolutions per minute (RPM), the operation is executed in program.

E) The example that number of pulse per 1 revolution set to '1' and time is set to 1000 ms is as shown below. (Ch0)

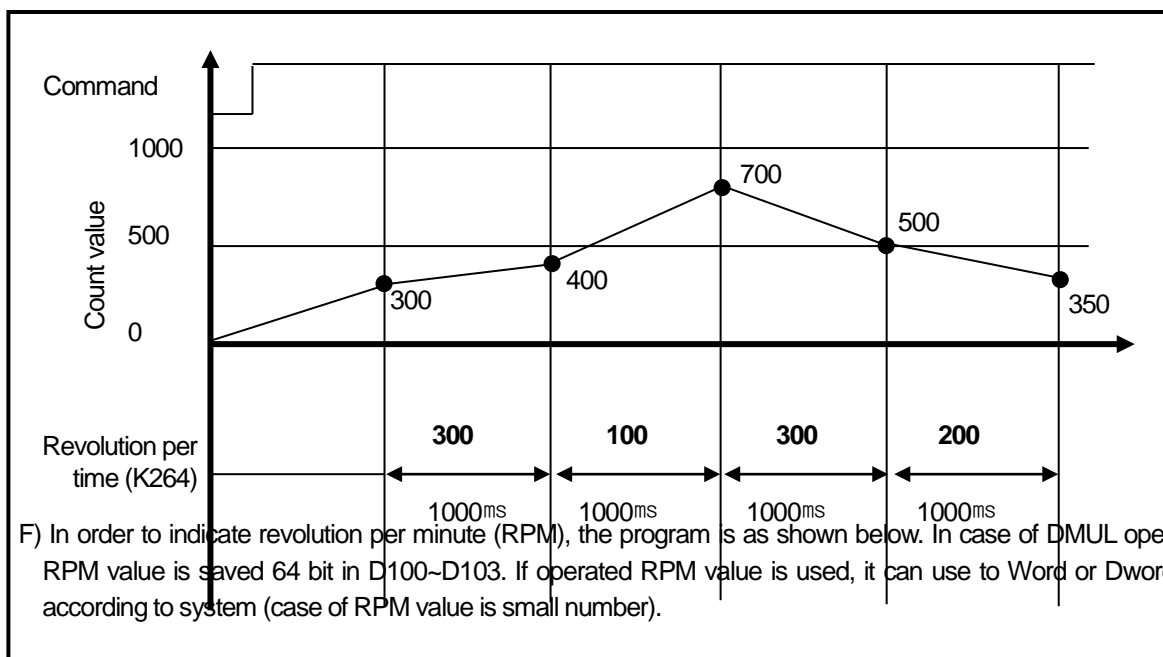

$D100 \text{ (RPM value)} = K264 \text{ (number of revolution per second)} \times 60 \text{ (second)}$

F00099  
Always ON

DMUL K0264 60 D00100

G) The example that number of pulse per 1 revolution set to '10' and time is set to 60,000 ms is as shown below.

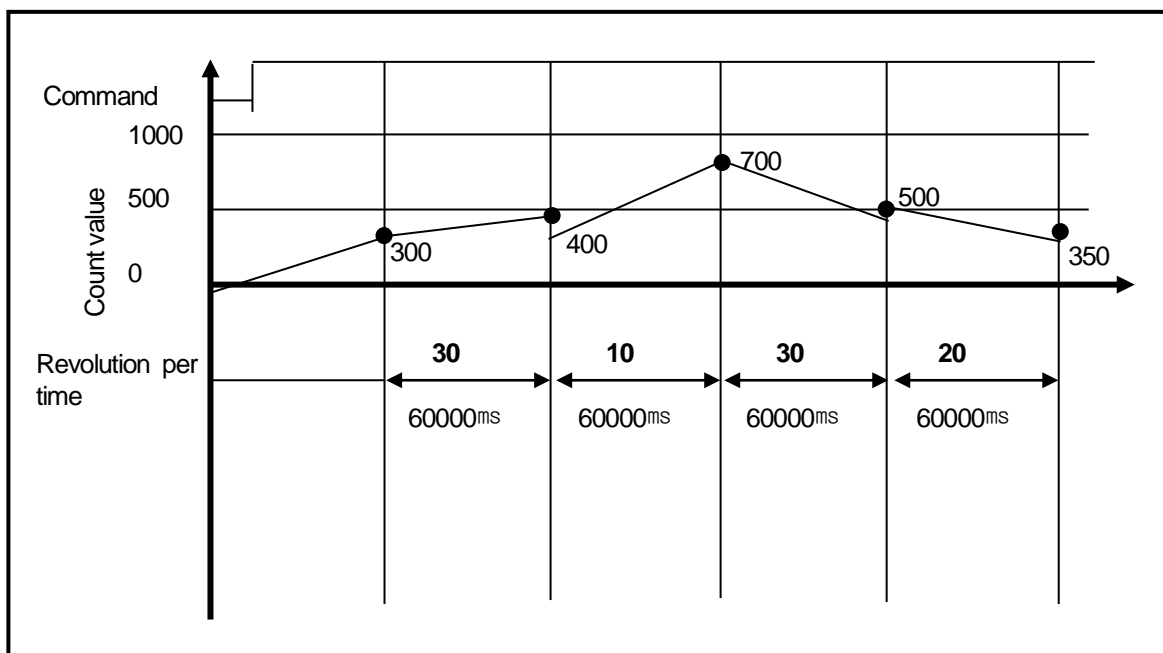

## (7) Count latch

(a) When Count latch signal is On, present count value is latched.

(b) Setting

If present counter value is to latch, Count Latch function is set 'Use'.

Classification	Device area per channel			
	Channel 0	Channel 1	Channel 2	Channel 3
Count latch command	K2606	K2706	K2806	K2906

- Count latch function is operated when Count latch signal is On. Namely, counter value is not cleared when power supply Off =>On and mode change, it is counted from previous value.
- In latch counter function, internal or external preset function has to use for clearing present value.



## (8) Preset function

It changes the current value into preset value.

There are two types of preset function, internal preset and external preset. External preset is fixed as input contact point.

Parameter	CH 0	CH 1	CH 2	CH 3
<input type="checkbox"/> Counter mode	Linear	Linear	Linear	Linear
<input type="checkbox"/> Pulse input mode	1-Phs 1-In x1	1-Phs 1-In x1	1-Phs 1-In x1	1-Phs 1-In x1
Internal preset	0	0	0	0
External preset	0	0	0	0
Ring counter value	0	0	0	0
<input type="checkbox"/> Comp output mode	(Magnitude)<	(Magnitude)<	(Magnitude)<	(Magnitude)<
Comp output min.	0	0	0	0
Comp output max.	0	0	0	0
<input type="checkbox"/> Comp output point	No use	No use	No use	No use
Unit time [ms]	1	1	1	1
Pulse/Rev value	1	1	1	1

- Preset setting value is saved at the following special K area.

Type	Area per each channel (Double word)				Ref.
	Ch.0	Ch.1	Ch.2	Ch.3	
Internal preset	K304	K334	K364	K394	-
External preset	K306	K336	K366	K396	-

- Preset command is specified through the following special K area, external preset is used by executing the designated input contact point after allowance bit is on.

Type	Area per each channel (Bit)				Ref.
	Ch.0	Ch.1	Ch.2	Ch.3	
Internal preset command	K2601	K2701	K2801	K2901	-
External preset allowance	K2602	K2702	K2802	K2902	-
External preset command	P008	P009	P00A	P00B	-

## 4.2 Installation and Wiring

### 4.2.1 Precaution for wiring

Pay attention to the counteractions against wiring noise especially for High-speed pulse input.

- 1) Surely use twisted pair shielded cable, grounded with 3 class applied.
- 2) Keep away from power cable or I/O line which may cause noise.
- 3) Stabilized power should be used for filter.
  - ▶ Connect A-phase only for 1-phase input.
  - ▶ Connect A-phase and B-phase for 2-phase input.

### 8.2.2 Example of wiring

(1) In case of pulse generator (encoder) is voltage output type

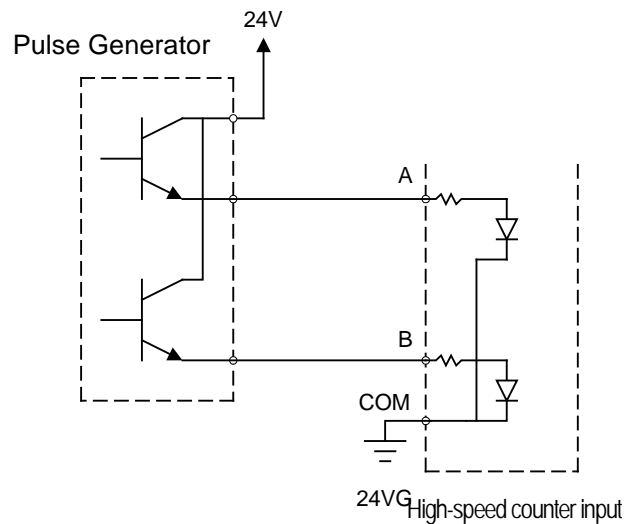

(2) In case of pulse generator is open collector type

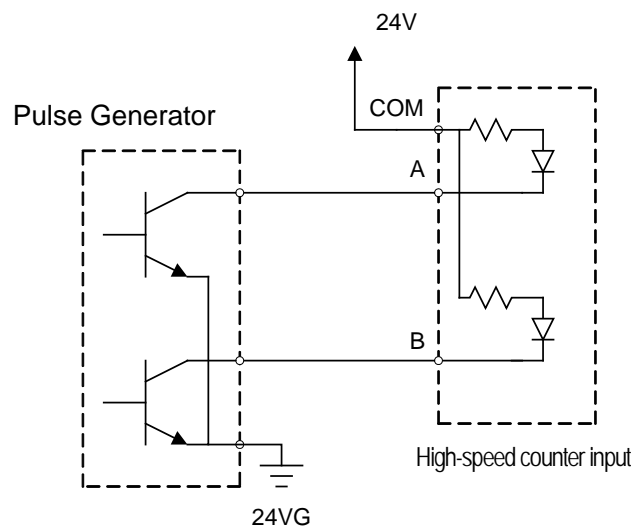

## 4.3 Internal Memory

### 4.3.1 Special area for High-speed counter

Parameter and operation command area of built-in high-speed counter use a special K device.

If values set in parameter are changed, it works with the changed values. At the moment, makes sure to use WRT command to save the changed value to flash. If not saved in flash, the changed values with the power off => on and mode changed may not be maintained.

- The following example shows that the internal preset values of CH1 set in parameter are changed by program and saved in flash.
  - Receiving an order command (M000), it moves (MOV) the new internal preset value (5000) to the CH1 present area (K332).
  - To save the changed settings into flash, it uses WRT command. At the moment, slot information is set to '0' in case of built-in function.

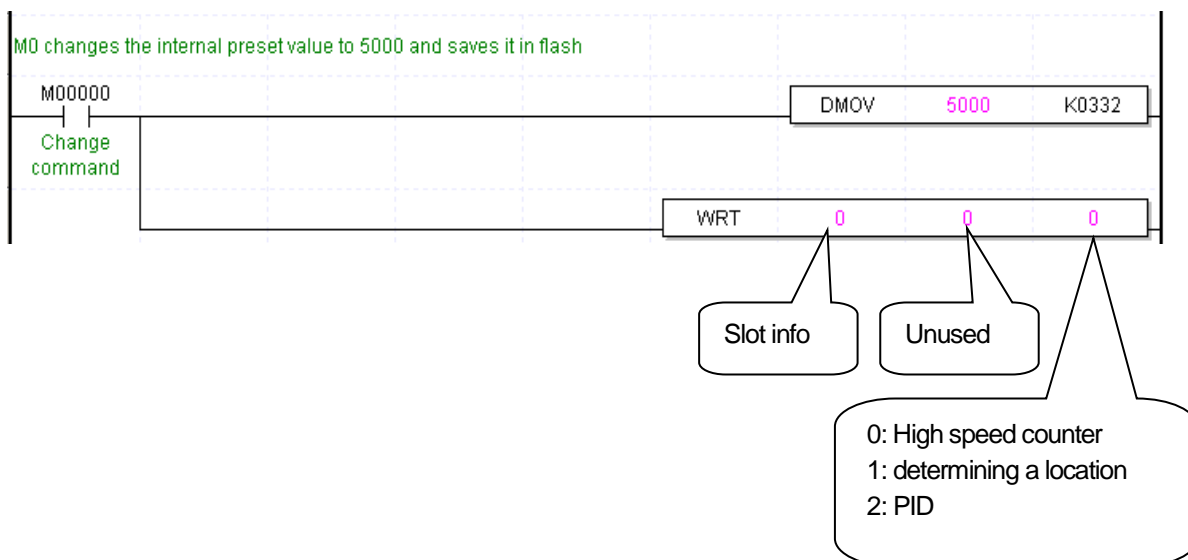

## Chapter 4 Built-in High-speed Counter Function

## (1) Parameter setting

Parameter	Description		Device area per channel				Remark
	Value	Setting	Ch 0	Ch 1	Ch 2	Ch 3	
Counter mode	h0000	Linear count	K300	K330	K360	K390	Word
	h0001	Ring count					
Pulse input mode	h0000	1 phase 1 input 1 multiplication	K301	K331	K361	K391	Word
	h0001	1 phase 2 input 1 multiplication					
	h0002	CW / CCW					
	h0003	2 phase 4 multiplication					
Comp. Output mode	h0000	(Magnitude) <	K302	K332	K362	K392	Word
	h0001	(Magnitude) ≤					
	h0002	(Magnitude) =					
	h0003	(Magnitude) ≥					
	h0004	(Magnitude) >					
	h0005	(Range) Include					
	h0006	(Range) Exclude					
Internal preset value setting	-2,147,483,648 ~ 2,147,483,647		K304	K334	K364	K394	DWord
External preset value setting	-2,147,483,648 ~ 2,147,483,647		K306	K336	K366	K396	DWord
Ring counter Max. value setting	-2,147,483,648 ~ 2,147,483,647		K310	K340	K370	K400	DWord
Comp. Output Min. value setting	-2,147,483,648 ~ 2,147,483,647		K312	K342	K372	K402	DWord
Comp. output Max. value setting	-2,147,483,648 ~ 2,147,483,647		K314	K344	K374	K404	DWord

## Chapter 4 Built-in High-speed Counter Function

Parameter	Description		Device area per channel				Remark
	Value	Setting	Ch 0	Ch 1	Ch 2	Ch 3	
Comp. output 0 point designation	HFFFF	No use	K320	K350	K380	K410	Word
	h0000	P0020					
	h0001	P0021					
	h0002	P0022					
	h0003	P0023					
	h0004	P0024					
	h0005	P0025					
	h0006	P0026					
	h0007	P0027					
	h0008	P0028					
	h0009	P0029					
	h000A	P002A					
	h000B	P002B					
	h000C	P002C					
	h000D	P002D					
	h000E	P002E					
h000F	P002F						
Comp. output 1 point designation	HFFFF	No use	K321	K351	K381	K411	Word
	h0000	P0020					
	h0001	P0021					
	h0002	P0022					
	h0003	P0023					
	h0004	P0024					
	h0005	P0025					
	h0006	P0026					
	h0007	P0027					
	h0008	P0028					
	h0009	P0029					
	h000A	P002A					
	h000B	P002B					
	h000C	P002C					
	h000D	P002D					
	h000E	P002E					
h000F	P002F						
Unit time [ms]	1 ~ 60,000		K322	K352	K382	K412	DWord
Pulse/Rev.value	1 ~ 60,000		K323	K353	K383	K413	DWord
Frequency	h0000	1Hz	K324	K354	K384	K414	Word
	h0001	10Hz					
	h0002	100Hz					
	h0003	1000Hz					

## Chapter 4 Built-in High-speed Counter Function

## (b) Operation command

Parameter	Device area per channel			
	Ch 0	Ch 1	Ch 2	Ch 3
Counter enabling	K2600	K2700	K2800	K2900
Internal preset designation of counter	K2601	K2701	K2801	K2901
External preset enabling of counter	K2602	K2702	K2802	K2902
Designation of decremental counter	K2603	K2703	K2803	K2903
Comp. output enabling	K2604	K2704	K2804	K2904
Enabling of revolution time per unit time	K2605	K2705	K2805	K2905
Designation of latch counter	K2606	K2706	K2806	K2906
Carry signal (Bit)	K2610	K2710	K2810	K2910
Borrow signal	K2611	K2711	K2811	K2911
Comp. output signal	K2612	K2712	K2812	K2912

## (c) Area of monitoring

Parameter	Device area per channel				Remark
	Ch 0	Ch 1	Ch 2	Ch 3	
Current counter value	K262	K272	K282	K292	DWord
Revolution time per unit time	K264	K274	K284	K294	DWord

### 4.3.2 Error code

It describes errors of the built-in high-speed counter.

- Error occurred is saved in the following area.

Category	Device area per channel				Remark
	Ch0	Ch1	Ch2	Ch3	
Error code	K266	K276	K286	K296	Word

- Error codes and descriptions

Error code (Decimal)	Description	Remark
20	Counter type is set out of range	
21	Pulse input type is set out of range	
22	Requesting #1(3,5,7)channel Run during the 2-phase operation of #0(2,4,6) * During #0(2,4,6) channel 2-phase operation, using #1(3,5,7)channel is not possible.	
23	Compared output type setting is set out of range.	
25	Internal preset value is set out of counter range	
26	External present value is set out of counter range	
27	Ring counter setting is set out of range * Note ring counter setting should be 2 and more.	
28	Compared output min. value is set out of permissible max. input range	
29	Compared output max. value is set out of permissible max. input range	
30	Error of Compared output min. value>Compared output max. value	
31	Output point designation value of Compared output is set out of range	
34	Set value of Unit time is out of the range	
35	Pulse value per 1 revolution is set out of range	
36	Compared output min. value is set out of permissible max. input range (Compared output 1)	"H" type
37	Compared output max. value is set out of permissible max. input range (Compared output 1)	"H" type
38	Error of Compared output min. value>Compared output max. value (Compared output 1)	"H" type
39	Output point designation value of Compared output is set out of range (Compared output 1)	"H" type
40	Frequency measure error	

#### Remark

- If two and more errors occur, the module saves the latter error code and removes the former one.

## 4.4 Examples: Using High-speed Counter

It describes examples of using high-speed counter.

### 1) Setting high-speed counter parameter

How to set types of parameters to operate a high-speed counter is described as follows.

A) Set 『Internal Parameters』 in the basic project window.

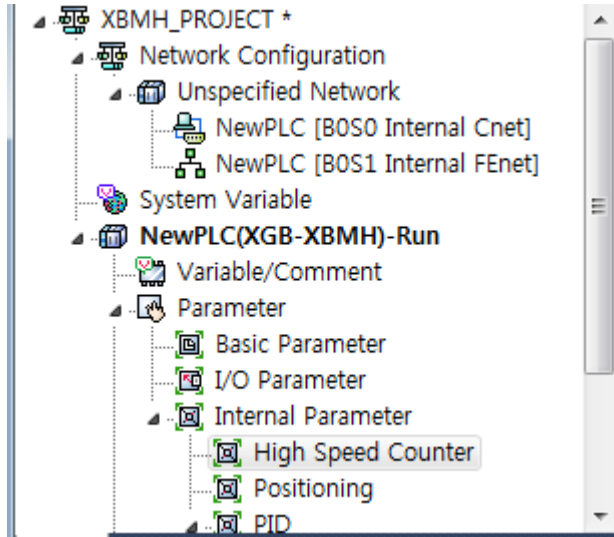

B) Selecting high-speed counter opens a window to set high-speed counter parameters as follows.

For details regarding each parameter setting, refer to 8.1~8.3.

(Every parameter settings are saved in the special K device area.)

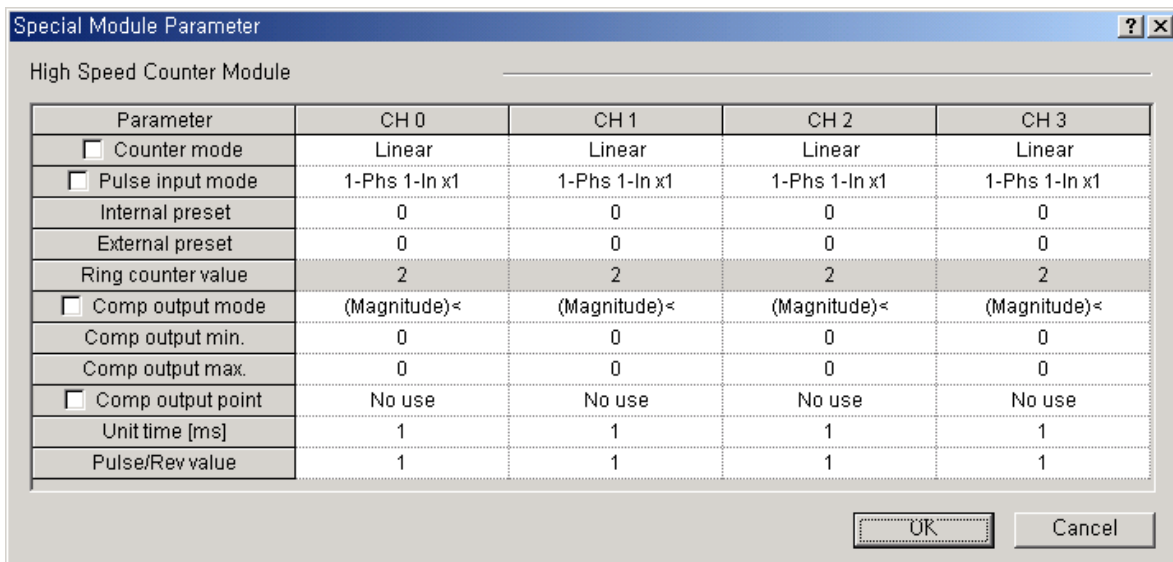



C) Turn 'ON' the high-speed counter Enable signal (CH0:K2600) in the program.



D) To use additional functions of the high-speed counter, you need to turn on the flag allowing an operation command.

\* Refer to 2. Operation Command, <8.3.1 Special K Area for High-speed Counter>

For instance, turn on 2605 bit if among additional functions, rotation number function is used.

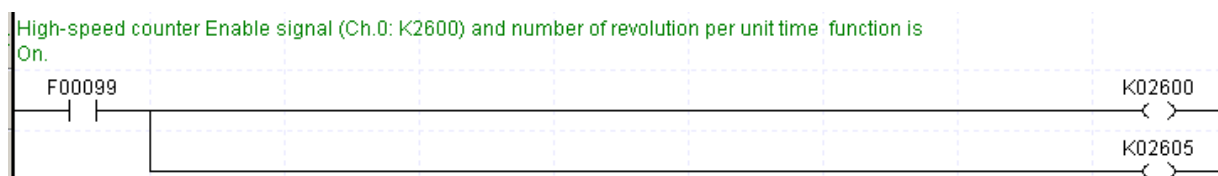

E) Upon the setting, download program and parameter to PLC.

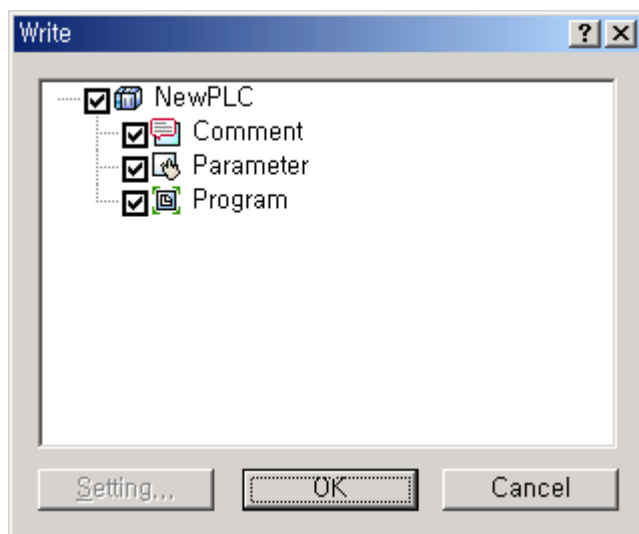

## Chapter 4 Built-in High-speed Counter Function

### 2) Monitoring and setting command

Monitoring and command setting of high-speed counter are described as follows.

A) If starting a monitor and clicking a Special Module Monitor, the following window is opened.

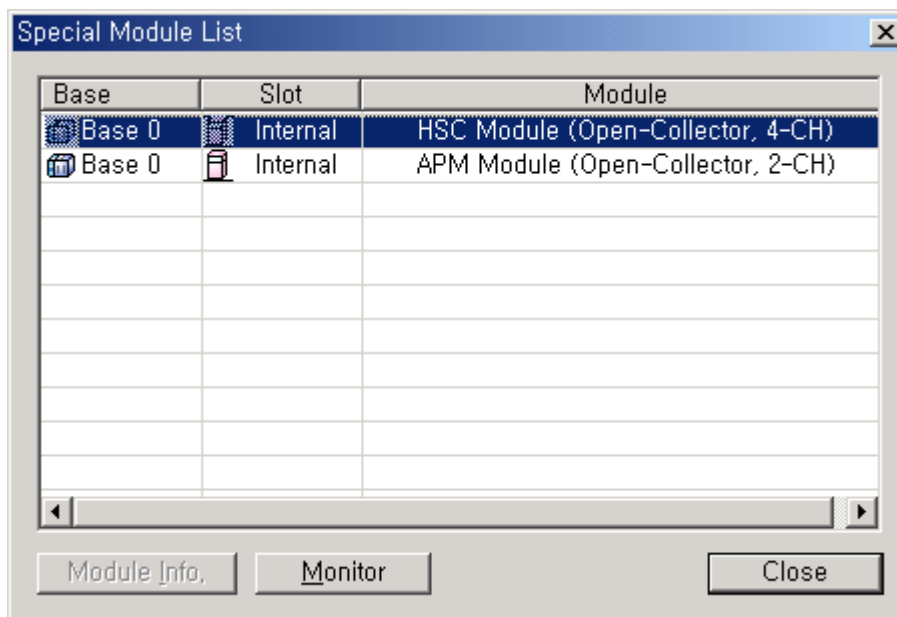
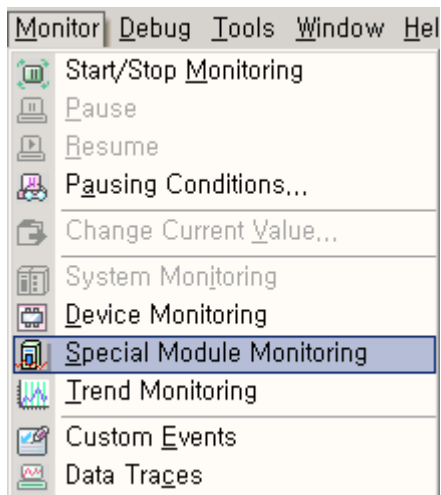

B) Clicking 『Monitor』 shows monitor and test window of high-speed counter.

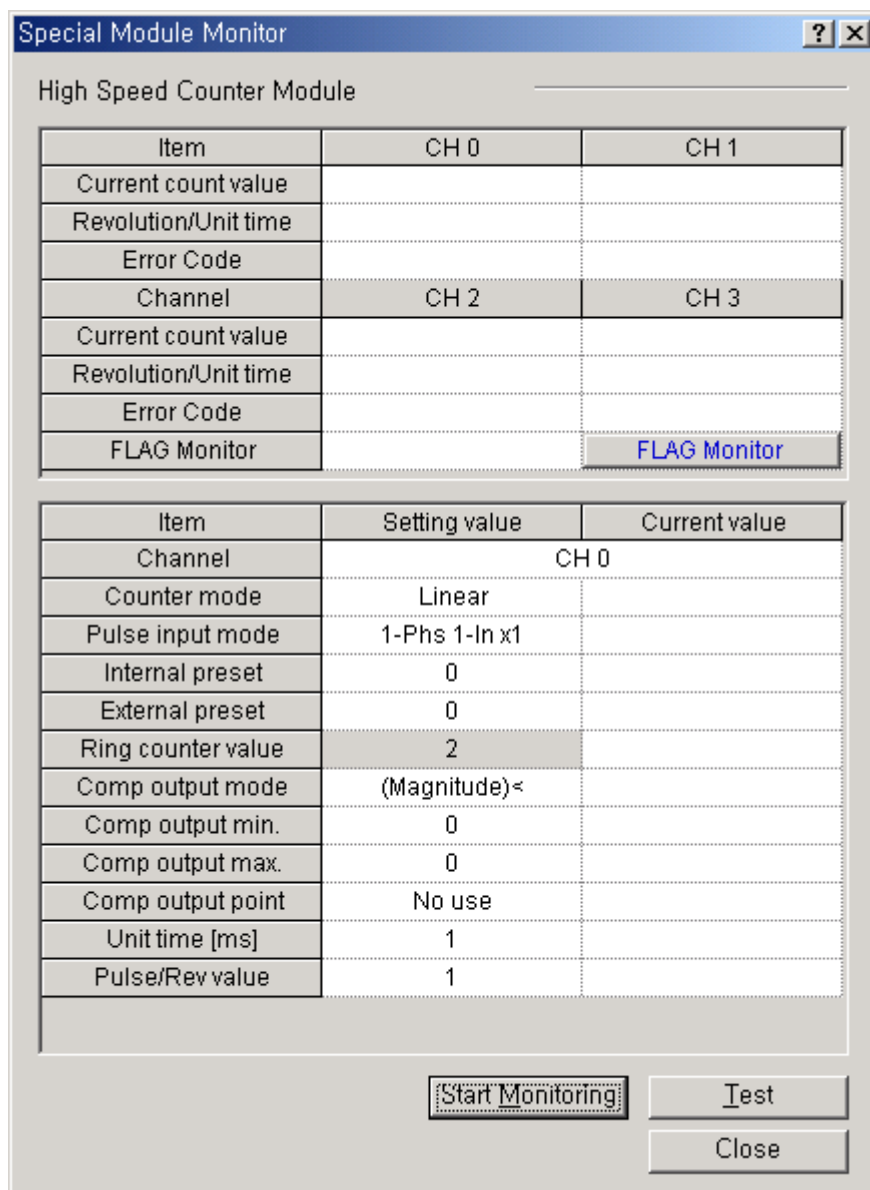

Item	Description
FLAG Monitor	Show flag monitoring and command window of high-speed counter
Start Monitoring	Start monitoring each item (special K device area monitor).
Test	Write each item setting to PLC. (Write the setting to special K device)
Close	Close monitor

## Chapter 4 Built-in High-speed Counter Function

- C) Clicking 『Start Monitoring』 shows the high-speed counter monitor display, in which you may set each parameter. At this moment, if any, changed values are not saved if power off=> on or mode is changed.

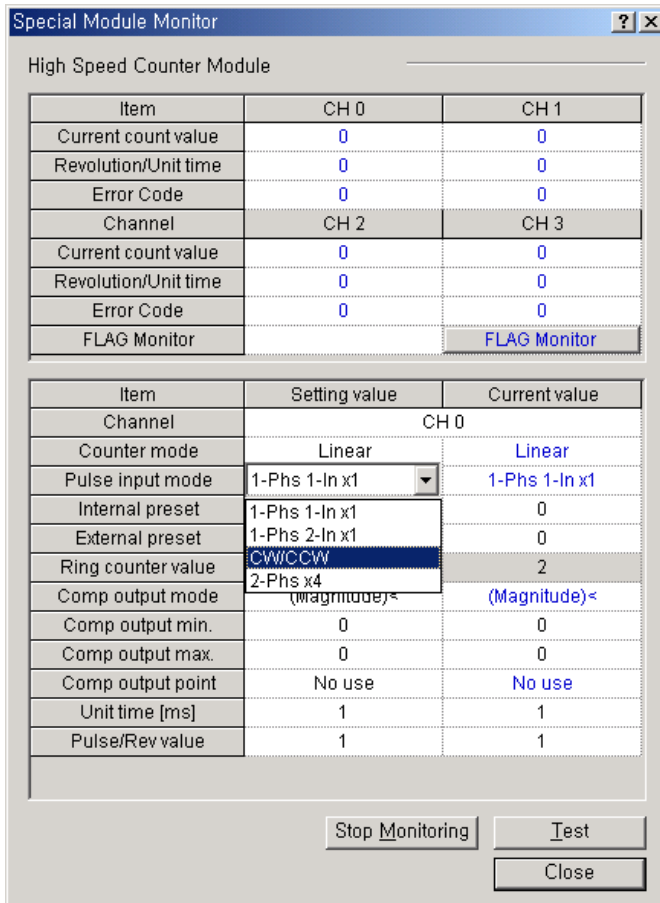

- D) Clicking 『FLAG Monitor』 shows the monitor of each flag in high-speed counter, in which you may direct operation commands by flags (clicking commands reverse turn).

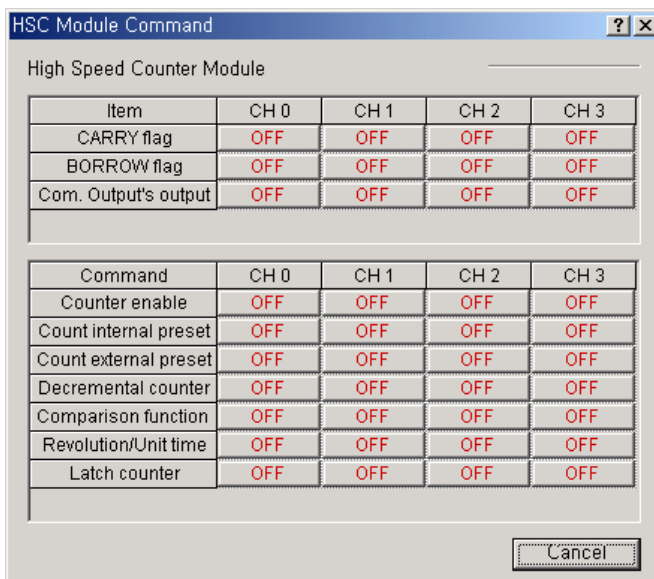



## Chapter 5. Built-in PID Function

### 5.1 Features of Built-in PID Function

Here describes built-in PID (Proportional Integral Derivative) function. When there is plant (target of control), Control means that the user changes the status such as velocity, temperature, position, voltage, current etc. as the user wishes. Here describes PID control that is most frequently used among diverse control methods.

Basic concept of PID control is as follows. First, it detects the PV (Process Value) through sensor and calculates what the difference with SV (Set value) is. Then it outputs MV (Manipulated Value) for PV to be same with SV.

At this time, 3 types of operation, such as Proportion, Integration, Derivation is executed according to the requirement of the user. PID control has high compatibility, flexibility, affordability in comparison with Robust control and Linear optimal control. In case of other control methods, since control device can be applied to the system after mathematical analysis of system, if system or the requirement of the user changes, the analysis of system is done again. But in case of PID control, PID device copes with change of system or requirement of the user with simple auto-tunings without analysis of system rapidly.

The figure 6.1 is example indicating system configuration of temperature control of heating system.

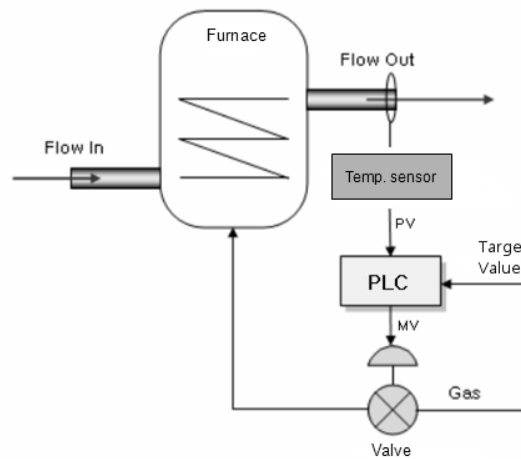

<Figure 6.1PID Temperature control system with PLC>

At this time, PLC becomes control device for this system, output temperature of heating system becomes target for control. And temperature sensor and valve becomes devices to detect and manipulate the status of system respectively. If temperature sensor detects the output temperature and inputs that to PLC, PLC manipulate the valve status through PID operation and control the quantity of gas that goes into heating system. So temperature of heating system changes. This process is called control loop and PID control is executed by repeating the control loop. The control loop is repeated with a cycle of ms ~ s.

The built-in PID control functions of XBM feature as follows.

- (1) Since operations are executed within CPU part, it can be controlled by PID parameters and PLC program without PID module.
- (2) A variety of controls can be selected
  - That is, a user can easily select P operation, PI operation and PID operation.
- (3) Precise control operation
  - It can make precise PID control operations possible through floating point operations.
- (4) PWM (Pulse Width Modulation) output available.
  - It outputs control operation results to the output contact point designated by a user through PWM.
- (5) Improving convenience of control settings and monitoring
  - Through parameter setting method and K area flag, it maximizes control parameter settings during operation and convenience of monitoring
- (6) Freely selectable operation direction
  - Forward, reverse and mixed forward/reverse operations are available
- (7) Cascade operation realizing quick and precise PID control
  - It can increase quickness of response to disturbance through cascade loop.
- (8) Various additional functions
  - PID control can be achieved by various methods a user wishes because set value ramp, the present value follow-up, limiting change of values and types of alarm functions are provided.

## 5.2 Basic Theory of PID Control

Here describes basic theory of PID control and how to configure PID control.

### (1) Terms

Terms used in this user manual are as follows.

- PV: status of plant detected by sensor (Process value)
- SV: Target value (Set Value) to control plant, if control is done normally, PV should follow the SV.
- E: error between SV and PV. It can be expressed as (SV-PV).
- K<sub>p</sub>: proportional coefficient
- T<sub>i</sub>: Integral time constant. Sometimes called integral time
- T<sub>d</sub>: Derivative time constant. Sometimes called derivative time
- MV: Control input or control device output. The input to plant to make PV follow the V
- T<sub>s</sub>: Sampling time, a cycle of operation to execute PID control

### (2) PID operation expression

Basic PID operation expressions are as follows.

$$E = SV - PV \quad (6.2.1)$$

$$MV_p = K_p E \quad (6.2.2)$$

$$MV_i = \frac{K_p}{T_i} \int E dt \quad (6.2.3)$$

$$MV_d = K_p T_d \frac{dE}{dt} \quad (6.2.4)$$

$$MV = MV_p + MV_i + MV_d \quad (6.2.5)$$

PID control operation expressions of XGB series are more complicated than expressions (6.2.1) ~ (6.2.5) mathematically but those are based on the above expression. The followings describe the characteristics of control process with an example that controls the output temperature of heating system in figure 6.1. At this example, the system and PID parameters are imaginary to help the comprehension and those may be different with real heating system. If the heating system in figure 6.1 is expressed as a second order system with transfer function like expression (6.2.6) in frequency domain, it is expressed as differential equation like expression (6.2.7) in the time domain.

$$\text{Transfer function} = \frac{32}{(2s+1)(3s+5)} \quad (6.2.6)$$

$$\frac{6}{32} \frac{d^2 y(t)}{dt^2} + \frac{13}{32} \frac{dy(t)}{dt} + 5y(t) = x(t) \quad (6.2.7)$$

That is,  $x(t)$  is Manipulated value and  $y(t)$  is Process value.

At this system, we assume that the PID parameter is specified as shown below to describe the PID control operation.

Items	Value	Items	Value
Output temperature of heating system (PV)	0°C	Proportional coefficient ( $K_P$ )	5
Target temperature (SV)	50°C	Integral time ( $T_i$ )	3s
Cycle of operation	0.01s	Derivative time ( $T_d$ )	0.19s

<Table 6.1 example of control of heating system>

At this system, if we assume that target value of output temperature is 50°C and initial value of output temperature is 0°C, SV and PV becomes 50 and 0 respectively. In case of this, PID controller acts as follows.

### (3) Proportional control (P control)

In the proportional control, the controller yields output that is proportional to error.

Manipulated value of controller by Proportional control is as follows.

$$MV_P = E \times K_P \quad (6.2.8)$$

(a) If P control starts, output of controller by initial P operation is as follows.

$$MV_0 = 50 \times 4 = 200$$



If P control is executed for 10 seconds, output temperature will be as table 6.2.

If this is expressed with graph, it will be as Figure 6.2.

Time	Target temp.	Proportional coefficient	Output temp.	Error
0	50	5	0	50
1	50	5	44.98	5.02
2	50	5	53.08	-3.08
3	50	5	50.15	-0.15
4	50	5	48.42	1.58
5	50	5	48.28	1.72
6	50	5	48.44	1.56
7	50	5	48.49	1.51
8	50	5	48.49	1.51
9	50	5	48.49	1.51

< Table 6.2 example of Proportional control >

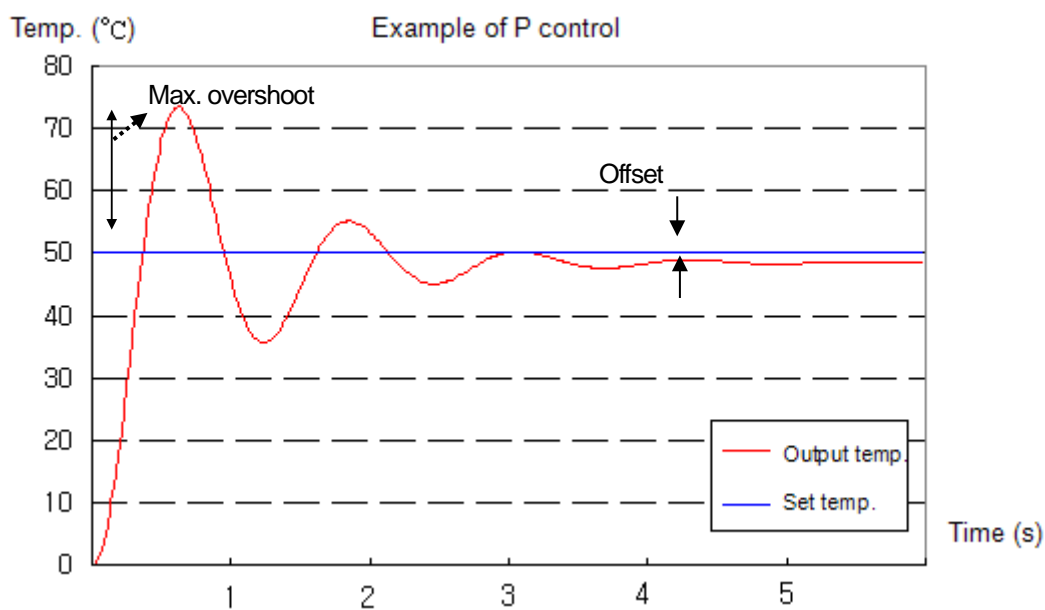

< Figure 6.2 simulation of proportional control >

(b) Concerning the result of simulation, it has the maximum overshoot of about 23.4°C at 0.62s and after 7s, it converges at 48.49°C with offset of 1.51°C (about 3%).

(c) Offset is an unavoidable error when only P control is executed. Offset decreases proportional to P coefficient but overshoot increases proportional to P coefficient. Table 6.3 and Figure 6.3 is simulation of offset and overshoot according to P coefficient.

Time	Target temperature	Kp = 5	Kp = 2.5	Kp = 1
0	50	0	0	0
1	50	45.02	63.46	46.67
2	50	53.11	42.52	46.77
3	50	50.15	47.93	41.38
4	50	50.22	47.25	41.60
5	50	48.27	46.96	43.30
6	50	48.35	46.92	43.25
7	50	48.44	46.90	43.21
8	50	48.53	46.90	43.18
9	50	48.53	46.90	43.18

<Table 6.3 Temperature- time table according to P coefficient>

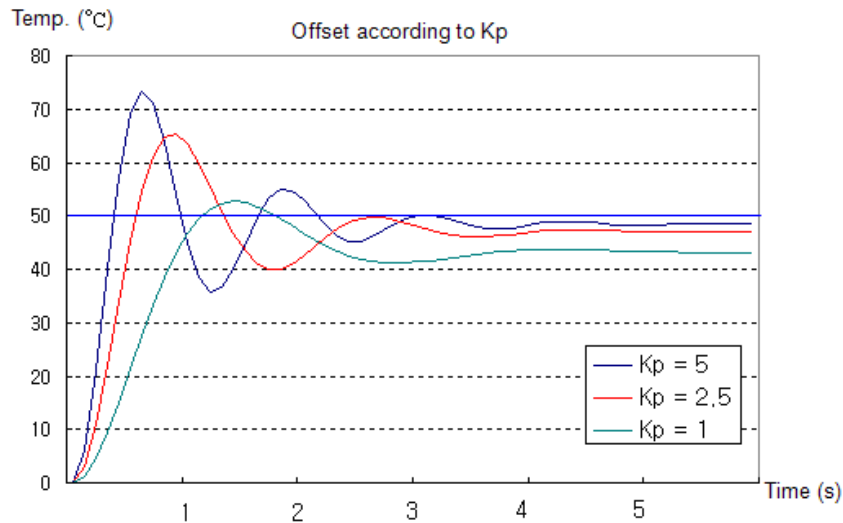

< Figure 6.3 Temperature- time graph according to P coefficient >

(c) Considering table 6.3, as P coefficient decreases, offset increases but overshoot decreases.

(d) Generally, offset can't be solved with only P control. In order to remove the offset, P control and I control is used together.

## (4) Proportional Integral Control (PI Control)

In I control, it yields the output proportional to error accumulated according to time. And the expression is as follows.

$$MV_i = \frac{K_P}{T_i} \int Edt \quad (6.2.9)$$

(a) In the expression 6.2.9,  $T_i$  means the time takes for  $MV_i$ , output by I control, to be added into real output.

(b) Generally, I control is used with P control. So the expression of PI control is as follows.

$$MV = MV_P + MV_i = E \times K_P + \frac{K_P}{T_i} \int Edt \quad (6.2.10)$$

(c) In the above heating system, the simulation results are as shown in the table 6.4 when proportional coefficient is 2.5 and integral time is 1.5s.

Time	Target temp.	Proportional coefficient	Integral time	P Control	PI Control
0	50	2.5	1.5	0	0
1	50	2.5	1.5	63.46	74.41
2	50	2.5	1.5	42.52	40.63
3	50	2.5	1.5	47.93	52.99
4	50	2.5	1.5	47.05	49.67
5	50	2.5	1.5	46.96	49.70
6	50	2.5	1.5	47.12	50.38
7	50	2.5	1.5	47.03	49.76
8	50	2.5	1.5	47.07	50.14
9	50	2.5	1.5	47.06	49.94
10	50	2.5	1.5	47.06	50.02
11	50	2.5	1.5	47.06	49.99
12	50	2.5	1.5	47.06	50.00
13	50	2.5	1.5	47.06	50.00
14	50	2.5	1.5	47.06	50.00
15	50	2.5	1.5	47.06	50.00

< Table 6.4 Temperature- time table according to P coefficient >

(d) Considering table 6.4 and Figure 6.4, if P and I control is used together, offset is removed and temp. converges at 50°C, target temp. after 12s

- (e) But in this case, convergence time is longer than that of P control and overshoot is larger. Generally, as integral time increases, overshoot decrease. About this, refer to the Figure 6.5.

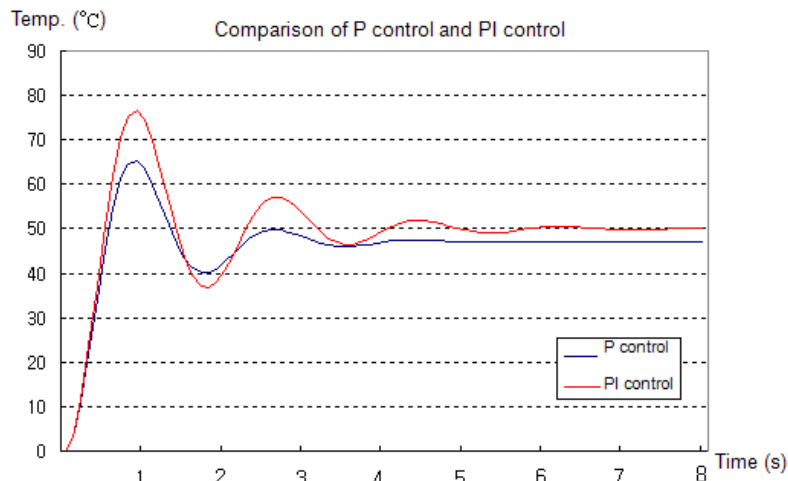

< Figure 6.4 Temp.- time graph >

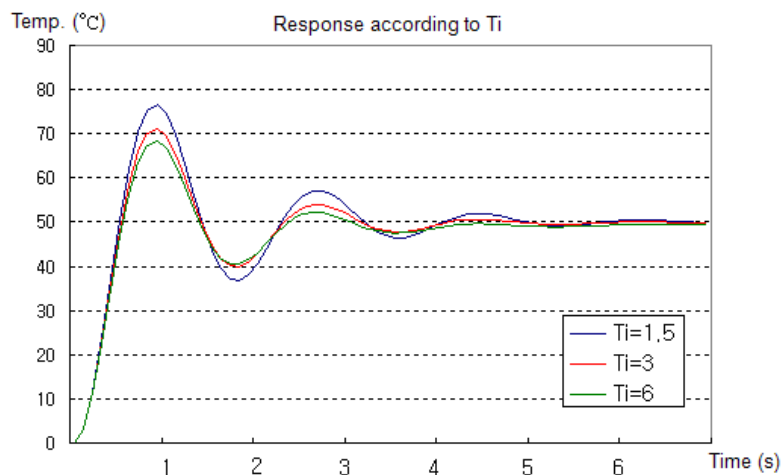

< Figure 6.5 overshoot according to integral time >

- (f) Like this, if I control is used, overshoot is larger. According to system, large overshoot can be problem. In order to solve this, PID control is used.
- (5) Proportional integral derivative control (PID control)

In D control, when status of system changes rapidly, D control yields the output to reduce the error. Namely, D control yields the output proportional to change velocity of current status. So if D control is used, response speed of controller about status change of system increases, and overshoot decreases. Output of controller by D control is as shown in expression 6.2.11.

$$MV_d = K_P T_d \frac{dE}{dt} \quad (6.2.11)$$

(a) In the expression 6.2.11,  $T_d$  means the time takes for  $MV_d$  output by I control, to be added into real output.

(b) Generally, D control is not used solely but with PD control. So PID control is expressed as expression 6.2.12.

$$MV = MV_p + MV_i + MV_d = E \times K_p + \frac{K_p}{T_i} \int E dt + K_p T_d \frac{dE}{dt} \quad (6.2.12)$$

(c) The Figure 6.6 is simulation result when PID control is applied to above heating system.

Time	Target temp.	Proportional coefficient	Integral time	Derivative time	PI Control	PID Control
0	50	2.5	1.5	0.3	0	0
1	50	2.5	1.5	0.3	74.41	55.50
2	50	2.5	1.5	0.3	40.63	56.33
3	50	2.5	1.5	0.3	52.99	52.50
4	50	2.5	1.5	0.3	49.67	50.92
5	50	2.5	1.5	0.3	49.70	50.34
6	50	2.5	1.5	0.3	50.38	50.12
7	50	2.5	1.5	0.3	49.76	50.05
8	50	2.5	1.5	0.3	50.14	50.02
9	50	2.5	1.5	0.3	49.94	50.01
10	50	2.5	1.5	0.3	50.02	50.00
11	50	2.5	1.5	0.3	49.99	50.00
12	50	2.5	1.5	0.3	50.00	50.00
13	50	2.5	1.5	0.3	50.00	50.00

< Table 6.5 comparison of PI control and PID control >

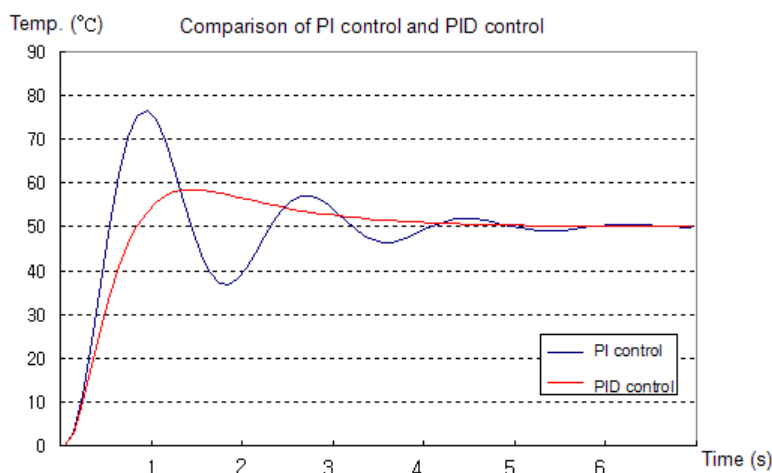

< Figure 6.6 comparison of PI control and PID control >

(d) Considering table 6.5, in case PID control is used, max. overshoot decreases from 16.5°C to 8.5°C. At this time, P coefficient, integral time, derivative time are not optimal values, just one of the examples. Actually, P coefficient, integral time, derivative time values vary according to PID control system.

### 5.3 Functional Specifications of PID Control

The performance specifications of the built-in PID control function in XGB series are summarized in the below table.

Item		Specifications
No. of loops		16 Loop
Scope of setting PID constants	Proportional constant(P)	Real number (0 ~ 3.40282347e+38)
	Integral constant(I)	Real number (0 ~ 3.40282347e+38), unit: second
	Differential constant(D)	Real number (0 ~ 3.40282347e+38), unit: second
Scope of set value		INT (-32,768 ~ 32,767)
Scope of present value		INT (-32,768 ~ 32,767)
Scope of maneuver value		INT (-32,768 ~ 32,767)
Scope of manual maneuver value		INT (-32,768 ~ 32,767)
Indication	RUN/STOP	Operation: PID RUN Flag On (by loops) Stop: PID RUN Flag Off (by loops)
	Error	Normal: PID Error Flag Off (by loops) Error: PID Error Flag On, Error code occurrence (by loops)
	Warning	Normal: PID Warning Flag Off (by loops) Error: PID Warning Flag On, Warnig code occurrence (by loops)
Control operation		Control of P,PI,PD and PID, control of forward/reverse operation
Control interval		10.0ms ~ 6,553.6ms (0.1msUnit)
Additional functions	PWM output	Supportable
	Mixed forward/reverse output	Supportable
	Limiting change of present value	INT (-32,768 ~ 32,767)
	Limiting change of maneuver value	INT (-32,768 ~ 32,767)
	Equally dividing set value	0 ~ 65,536 (frequency of control cycle time)
	Present value follow-up	0 ~ 65,536 (frequency of control cycle time)
	Cascade control	Supportable.
	Min./max. present value	-32,768 ~ 32,767
	Differential filter	0.01 ~ 655.35 (x 100 Scaled Up)
	Dead band setting	0 ~ 65,535
	Prevention of dual integral accumulation	Supportable
	PID operation pause	Supportable

< Table 6.6 built-in PID control performance specification >

## 5.4 Usage of PID Control Functions

### 5.4.1 PID Control Parameter Setting

To use the built-in PID control function of XGB series, it is necessary to set PID control parameters by loops in the parameter window and operate it through the commands. Here, it explains parameters to use PID control functions and how to set them.

#### (1) PID parameter settings

Follow the steps below to set the PID control function parameters of XGB series.

- (a) If selecting the built-in parameters in Parameter of the project window, it shows the built-in parameter setting window as in below figure.

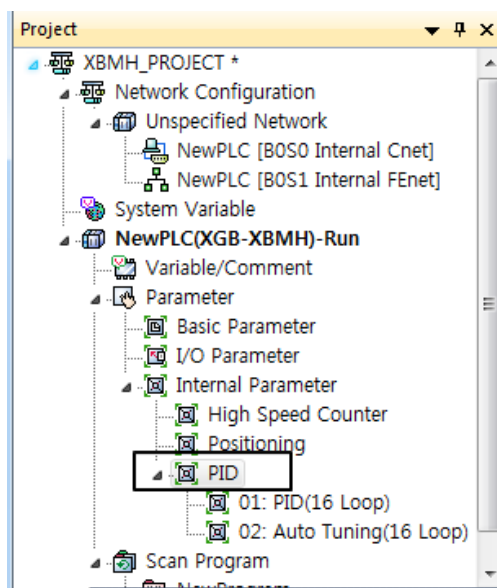

< Figure 6.7 Parameters setting window >

- (b) If selecting PID Control, it shows the PID control parameter setting window as in below figure.

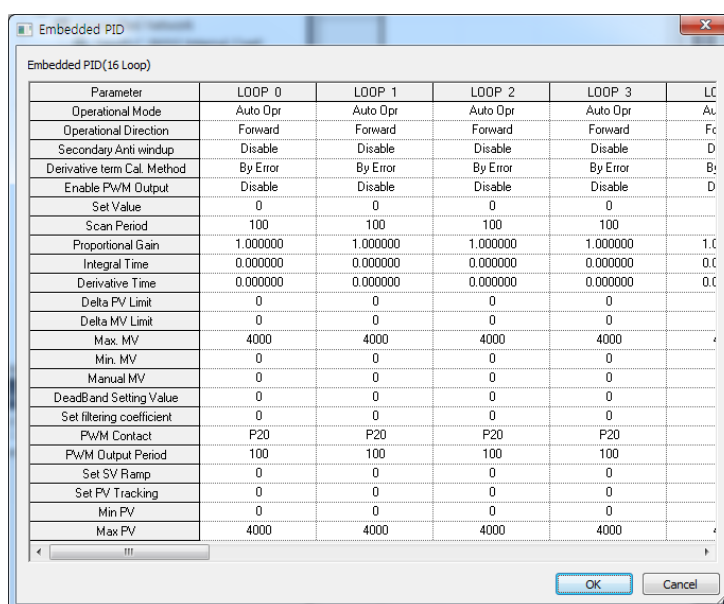

[ Figure 6.8 Built-in PID function parameters setting window ]

## Chapter 5 Built-in PID Function

### (c) Input items

The items to set in the built-in PID function parameter window and the available scope of them are summarized in below table.

Items	Description	Scope
RUN mode	Set the operation mode of PID control.	Auto/manual operation
RUN direction	Set the operation direction of PID control.	Forward/reverse
Prevention of dual integral accumulation	Set whether to allow dual integral accumulation.	Disabled/enabled
PWM output	Set whether to allow PWM output of maneuver value.	Disabled/enabled
Operation cycle time	Set the operation cycle time of PID control cycle.	100 ~ 65535
Set value	Set target control value.	-32,768 ~ 32,767
Proportional gain	Set proportional gain.	Real number
Integral time	Set integral time.	Real number
Differential time	Set differential time.	Real number
Limiting change of present value	Set the limited change of present value per operation cycle.	-32,768 ~ 32,767
Limiting change of maneuver value	Set the limited change of maneuver value per operation cycle.	-32,768 ~ 32,767
Max. maneuver value	Set the max. maneuver value for control.	-32,768 ~ 32,767
Min. maneuver value	Set the min. maneuver value for control.	-32,768 ~ 32,767
Manual maneuver value	Set the manual maneuver value for control.	-32,768 ~ 32,767
DeadBand setting	Set the deadband width of the set value.	0 ~ 65,535
Differential filter value	Set the filter coefficient of differential operation.	0 ~ 65,535
PWM junction	Set the junction to which PWM output is out.	P20 ~ P3F
PWM output cycle	Set the output cycle of PWM output.	100 ~ 65,535
Set value ramp	Set the frequency of set value ramp.	0 ~ 65,535
Present value follow-up	Set the follow-up frequency of the present value follow-up function.	0 ~ 65,535
Min. present value	Set the min. value of the input present value.	-32,768 ~ 32,767
Max. present value	Set the max. value of input present value.	-32,768 ~ 32,767

< Table 6.7 PID function parameter setting items >

### (2) Description of Setting of PID Parameters

#### (a) Operation mode

It is the mode to set the operation for PID control of a loop in question.

The available scope is automatic operation or manual operation.

If automatic operation is selected, it outputs the PID control result internally operated by the input PID control parameter as the maneuver value while if manual operation is selected, it outputs the value input to the manual maneuver value parameter without PID operation modified. The default is automatic operation.

#### (b) Operation direction

It is designed to set the operation direction for PID control of a loop in question. The available scope is forward or reverse direction. At the moment, forward direction means increase of PV when MV increases; reverse direction means decrease PV when MV increases. For instance, a heater is a kind of forward direction system because PV(temperature) increases when output(heating) increases. A refrigerator is a kind of reverse direction system in which PV(temperature) decreases when output increases.



## (c) Prevention of dual integral accumulation

It makes dual integral accumulation function enabled/disabled. To understand integral accumulation prevention function, it is necessary to explain the phenomenon of integral accumulation first of all. Every drive has a limit. That is, a motor is limited to the speed and a valve can become status overcoming the complete open/close. If it happens that MV output from a control is beyond the output limit of a drive, its output is maintained as saturated, which may deteriorate the control performance of a system and shorten the life of a drive. Formula (6.2.3) shows that the integral control among PID control output components accumulates errors as time goes on, from which it may take more time to return the normal status after the actuator is saturated in a system of which response characteristically is slow. It is so called integral accumulation phenomenon as illustrated in Fig. 6.9, which shows that if the initial error is very large, the error is continuously accumulated by integral control. Accordingly, a drive is saturated within its output upper limit while the control signal is getting larger, keeping being saturated for a long while until the drift becomes negative and the integral term turns small enough. Due to the operation, the PV may have a large over-shoot as seen in the figure. Such a wind-up phenomenon may occur if the initial drift is large or by a large disturbance or due to malfunction of a device.

The PID function of XGB series is basically with the integral accumulation prevention function, cutting off any integral accumulation phenomenon. In addition, it can detect a time when SV is suddenly decreased, providing a more strong dual integral accumulation prevention function.

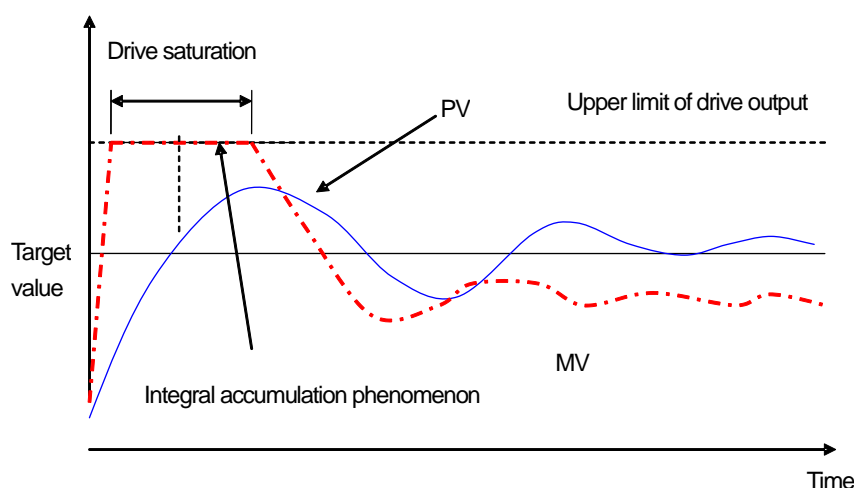

< Figure 6.9 Integral accumulation phenomenon >

## (d) PWM Output Enabled

PWM output means an output method to turn a junction on – off with a duty proportional to control output calculated by a uniform output cycle. If PWM output is enabled, it realizes PWM output in accordance with PWM output cycle set in the parameter of PWM output junction(P20 ~ P3F) designated in the parameter. At the moment, the PWM output cycle follows the PWM output cycle separately set in PID operation cycle. PWM output cycle is available between 10ms ~ 6553.5ms (setting value: 100 ~ 65,535) while it is set at a unit of integer per 0.1ms. figure shows the relation between PID control output and PWM output.

Ex) if PWM output cycle: 1 second, PWM output junction: P20, max. output: 10000, min. output: 0

Time	Output	P40 junction operation
0 sec	5000	0.5 sec On, 0.5 sec Off
1 sec	3000	0.3 sec On, 0.7 sec Off

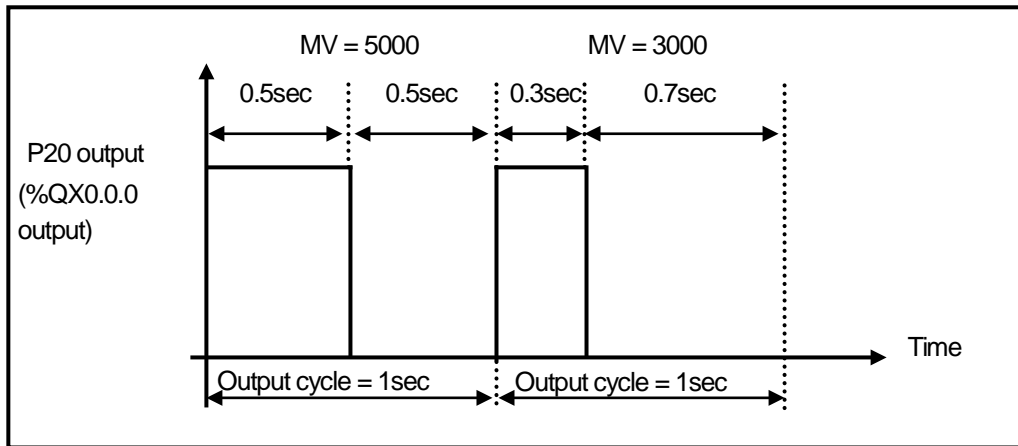

[ Figure 6.10 Relation between PWM output cycle and MV ]

(e) Set value

It sets the target of a loop in question, that is, the target status a user wishes to control. In case of the PID control built in XGB, physical values (temperature, flow rate, pressure and etc) of an object to control is not meaningful and instead, it should use the physical amount of an object to control after converting them into numerals. For instance, in order to control a system using a sensor that the output is 0V when its heating device temperature is 0°C while it is 10V when the temperature is 100°C as much as 50°C, it is necessary to set SV as 2000 (as long as it uses AD input module XBE-AD04A).

(f) Operation cycle

It sets the cycle to yield control output by executing the built-in PID operation. The setting cycle is 0.1ms and available between 10ms ~ 6553.5ms (setting value: 100 ~ 65,535) while it is set at a unit of integer per 0.1ms. For instance, to set PID operation per 100ms, set the operation cycle as 1000.

(g) Proportional gain

It is intended to set the proportional coefficient of a PID loop in question ( $K_p$ ). As larger  $K_p$ , the proportional control operation is getting stronger. The scope is real number.

(h) Integral time

It sets the integral time of PID loop in question ( $T_i$ ). As larger the integral time, the integral operation is getting weaker. The scope is real number at the unit of second.

(i) Differential time

It sets the differential time of PID loop in question ( $T_d$ ). As larger the differential time, the differential operation is getting stronger. The scope is real number at the unit of second.

(j) Limiting change of present value

It sets the limit of change in present value of PID loop in question. If PV suddenly changes due to signal components such as sensor's malfunction, noise or disturbance during control of PID, it may cause sudden change of PID control output. To prevent the phenomenon, a user can set the max. limit of change in present value that is allowed per PID operation cycle. If the change of present value is limited accordingly, it may calculate the present value as much as the limit although the present value is changed more than the limit once the limit of change in present value is set. If using the PV change limit function, it may prevent against sudden change of control output owing to noise or etc. If it is, however, set too small, it may reduce the response speed to the PV change of an actual system, not to sudden change by noise or etc, so it is necessary to set the value appropriately according to the environment of a system to control in order that the PV toward the set value does not take a longer time. The available scope is between -32,768~32,767. If setting the PV change limit as 0, the function is not available.

(k) Limiting change of MV ( $\Delta$ MV function)

It limits the max. size that control output, which is output by PID operation is changed at a time. The output MV in this operation cycle is not changed more than the max. change limit set in the previous operation cycle. The function has an effect to prevent a drive from operating excessively due to sudden change of output by preventing sudden change of output resulting from instantaneous change of set value. If it is, however, set too small, it may cause taking a longer time until PV reaches to its target, so it is necessary to adjust it appropriately. The available scope is between -32,768 ~ 32,767. If setting it as 0, the function does not work.

## (l) Max. MV

It sets the max. value of control output that may be output by the result of PID operation. The available scope is between -32,768 ~ 32,767. If it exceeds the max. output designated by PID operation result, it outputs the set max. output and alerts the max. output excess warning. For the types and description of warnings, refer to Error/Warning Codes.

## (m) Min. MV

It sets the min. value of control output that may be output by the result of PID operation. The available scope is between -32,768 ~ 32,767. If it is smaller than the min. output value designated by PID operation result, it outputs the set min. MV and alerts the min. output shortage warning. For the types and description of warnings, refer to Error/Warning Codes.

## (n) Manual MV

It sets the output when the operation mode is manual. The available scope is between -32,768 ~ 32,767.

## (o) DeadBand setting

It sets the deadband between set value and present value. Although it may be important to reduce normal status reply of PV for its set value even when MV fluctuates heavily, depending on control system, it may be more important to reduce the frequent change of MV although the normal status reply is somewhat getting larger. DeadBand may be useful in the case. Below figure shows an example of DeadBand setting.

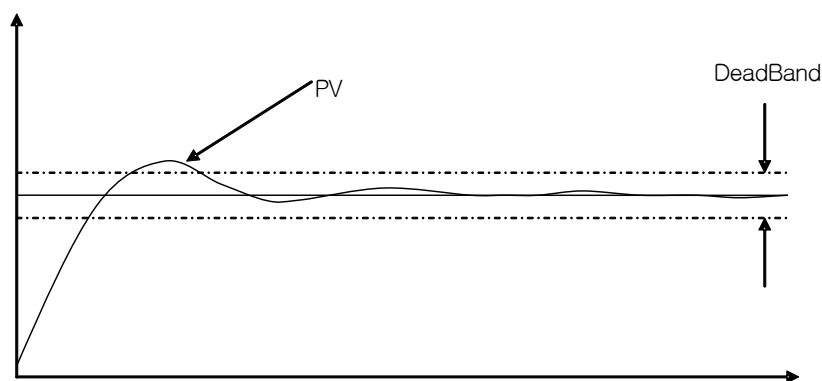

[ Figure 6.11 Example of DeadBand setting ]

If setting deadband as in the figure, the PID control built in XGB may regard the error between PV and set value as 0 as long as PV is within the available scope of deadband from set value.

That is, in this case, the change of MV is reduced. The available scope of setting is between 0 ~ 65,535 and if it is set as 0, it does not work.

## Chapter 5 Built-in PID Function

### (o) Differential Filter Value Setting

It sets the coefficient of differential filter. Since differential control outputs in proportion to gradient of error and gradient of PV change, it may suddenly change MV as it generates a large response to instantaneous noise or disturbance. To prevent it, XGB series uses a value to which PV is filtered mathematically for differential control. Differential filter value is the coefficient to determine the filter degree for differential control. As smaller differential value set, as stronger differential operation is. The available scope is between 0 ~ 65,535 and if it is set as 0, the differential filter does not work.

### (p) Setting set value ramp

Since the drift is suddenly large if SV is heavily changed during PID control, MV is also changed heavily to correct it. Such an operation may cause excessive operation of a system to control and a drive. To prevent it, SV ramp is used, changing SV gradually step by step when modifying SV during operation. If using the function, SV is gradually changed by SV ramp when SV is changed during PID control. At the moment, SV ramp setting represents the frequency of PID operation cycle taken from when SV starts changing to when it reaches to the final SV. For instance, if SV is to be changed from 1000 to 2000 during operation as PID operation cycle is 10ms and its SV ramp is 500, SV may reach to 2000 after  $500 \times 10\text{ms} = 5$  seconds, that is, as it increases each 2 per operation cycle and after the 500th operation scans. The available scope of setting is between 0 ~ 65,535 and it is set as 0, it does not work.

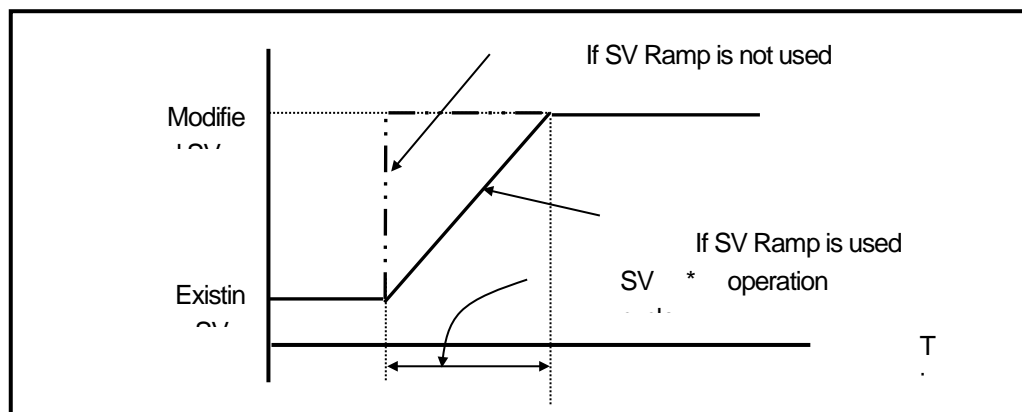

[ Figure 6.12 SV Ramp function ]

### (q) PV Follow-up setting

It is intended to prevent any excessive operation of a drive resulting from sudden change of output at the initial control and changes SV gradually from PV at the time when PID operation starts, not directly to SV in case control just turns from stop to operation mode or it changes from manual to automatic operation. At the moment, SV represents the frequency of PID operation cycles taken from when control starts to when it reaches to the set SV (other operations are same as SV ramp function). The available scope is between 0 ~ 65,535. If SV is changed again while PV follow-up is in operation, the SV would be also changed according to SV ramp.

### (r) Min./max. PV

It sets the min./max. value entered as the present value of PID control. The available scope is between -32,768 ~ 32,767.

## 5.4.2 PID Flags

The parameter set by the XGB series built-in PID control function is saved into the flash memory of the basic unit. Such parameters are moved to K area for the built-in PID function as soon as PLC turns from STOP to RUN mode. PID control operation by PID control command is executed through K area data for PID functions. Therefore, if a user changes the value in the trend monitor window or variable monitor window during operation, PID operation is executed by the changed value. At the moment, if PLC is changed to RUN again after being changed to STOP, it loads the parameters in flash memory to K area, so the data changed in K area is lost. Thus, to keep applying the parameters adjusted in K area, it is necessary to write the parameter set in K area to flash memory by using WRT command. (In case of IEC, APM\_WRT)

### (1) PID Flag Configuration

K area flags for XGB series built-in PID control function are summarized in the below table.

Loop	K area	IEC type	Symbol	Data type	Default	Description
Common	K12000~F	%KX19200~15	_PID_MAN	Bit	Auto	PID output designation (0:auto, 1>manual)
	K12010~F	%KX19216~31	_PID_PAUSE	Bit	RUN	PID pause (0:RUN, 1:pause)
	K12020~F	%KX19232~47	_PID_REV	Bit	Forward	Control direction(0:forward, 1:reverse) operation control
	K12030~F	%KX19248~63	_PID_AW2D	Bit	Disabled	Dual integral accumulation Prevention (0:enabled, 1:disabled)
	K12040~F	%KX19264~79	_PID_REM_RUN	Bit	Disabled	PID remote operation (0:disabled, 1:enabled)
	K1205~K1207	%KW1205~%KW1207	Reserved	WORD	-	Reserved area
	K12080~F	%KX19328~43	_PID_PWM_EN	Bit	Disabled	PWM output enable (0:disabled, 1:enabled)
	K12090~F	%KX19344~59	_PID_STD	Bit	-	PID operation indication (0:stop, 1:run)
	K12100~F	%KX19360~75	_PID_ALARM	Bit	-	PID warning (0:normal, 1:warning)
	K12110~F	%KX19376~91	_PID_ERROR	Bit	-	PID error(0:normal, 1:error)
	K12120~F	%KX19392~407	_PID_MV_BMPL	Bit	Disabled	PID MV BuMPLess changeover (0:disabled, 1:enabled)
Loop 0	K1213~K1215	%KW1213~%KW1215	Reserved	WORD	-	Reserved
	K1216	%KW1216	_PID00_SV	INT	0	PID SV
	K1217	%KW1217	_PID00_T_s	WORD	100	PID operation cycle[0.1ms]
	K1218	%KD609	_PID00_K_p	REAL	1	PID proportional constant
	K1220	%KD610	_PID00_T_i	REAL	0	PID integral time[sec]
	K1222	%KD611	_PID00_T_d	REAL	0	PID differential time[sec]
	K1224	%KW1224	_PID00_d_PV_max	WORD	0	PID PV change limit
	K1225	%KW1225	_PID00_d_MV_max	WORD	0	PID MV change limit
	K1226	%KW1226	_PID00_MV_max	INT	4000	PID MV max. value limit
	K1227	%KW1227	_PID00_MV_min	INT	0	PID MV min. value limit
	K1228	%KW1228	_PID00_MV_man	INT	0	PID manual output
K1229	%KW1229	_PID00_PV	INT	-	PID PV	

< Table 6.8 K area flags for PID control >

## Chapter 5 Built-in PID Function

Loop	K area	IEC type	Symbol	Data type	Default	Description
Loop 0	K1230	%KW1230	_PID00_PV_old	INT	-	PID PV of previous cycle
	K1231	%KW1231	_PID00_MV	INT	0	PID MV
	K1232	%KD616	_PID00_ERR	DINT	-	PID control error
	K1234	%KD617	_PID00_MV_p	REAL	0	PID MV proportional value component
	K1236	%KD618	_PID00_Mv_i	REAL	0	PID MV integral control component
	K1238	%KD619	_PID00_MV_d	REAL	0	PID MV differential control component
	K1240	%KW1240	_PID00_DB_W	WORD	0	PID deadband setting
	K1241	%KW1241	_PID00_Td_lag	WORD	0	PID differential filter coefficient
	K1242	%KW1242	_PID00_PWM	WORD	H'20	PID PWM junction setting
	K1243	%KW1243	_PID00_PWM_Prd	WORD	100	PID PWM output cycle
	K1244	%KW1244	_PID00_SV_RAMP	WORD	0	PID SV Ramp value
	K1245	%KW1245	_PID00_PV_Track	WORD	0	PID PV follow-up setting
	K1246	%KW1246	_PID00_PV_MIN	INT	0	PID PV min. value limit
	K1247	%KW1247	_PID00_PV_MAX	INT	4000	PID PV max. value limit
	K1248	%KW1248	_PID00_ALM_CODE	Word	0	PID warning code
	K1249	%KW1249	_PID00_ERR_CODE	Word	0	PID error code
	K1250	%KW1250	_PID00_CUR_SV	INT	0	PID SV of current cycle
		K1251-1255	%KW1251-1255	Reserved	WORD	-
Loop 1	K1256~K1295	%KW1256~%KW1295	-	-	-	PID Loop1 control parameter
~						
Loop16	K1816~K1855	%KW1816~%KW1855	-	-	-	PID Loop16 control parameter

&lt; Table 6.8 K area flags for PID control (continued) &gt;

K1200 ~ K1211 areas are the common bit areas of PID loops while each bit represents the status of each PID control loop. Therefore, each 16 bits, the max number of loops of XGB PID control represents loop status and setting respectively. K1216 ~ K1255 areas are K areas for PID control loop 0 and save the loop 0 setting and status. It also contains parameters such as SV, operation cycle, proportional coefficient, integral time and differential time set in the built-in parameter window and the XGB built-in PID function executes PID control by each device value in question. In addition, the output data such as MV calculated and output while PID control is executed is also saved into the K areas. By changing the values in K areas, control setting may be changed any time during PID control.

**Remark**

By changing value of area, you can change control setting whenever you want during the PID control

1) PID control flag expression : `_PID[n]_xxx`

→ [n] : loop number

→ xxx : flag function

Ex) `_PID10_K_p` : means `K_p` of loop 10.

## (2) PID flag function

Each function of K area flags for XGB series built-in PID control function is summarized as follows.

## (a) Common bit area

The area is a flag collecting operation setting and information consisting of bits to each 16 loop. Each bit of each word device represents the information of each loop. That is, 'n' th bit represents the information about PID loop n.

## 1) \_PID\_MAN (PID RUN mode setting)

Flag name	address	IEC type address	Unit	Setting
_PID_MAN (PID RUN mode setting)	K1200n	%KX19200 + n	BIT	Available

It determines whether to operate the PID control of n loop automatically or manually. For more information about RUN mode, refer to 6.2.3 PID control parameter setting. If the bit is off, it operates automatically; if on, it runs manually.

## 2) \_PID\_PAUSE (PID Pause setting)

Flag name	Address	IEC type address	Unit	Setting
_PID_PAUSE (PID pause setting)	K1201n	%KX19216 + n	BIT	Available

It changes PID control of n loop to pause status. If PID control is paused, the control MV is fixed as the output at the time of pause. At the moment, PID operation is continued internally with output fixed. If changing pause status to operation status again, it resumes control, so it may take a longer time until the PV is going to SV once system status is largely changed during pause. If the bit is off, it cancels pause; if on, it operates as paused.

## 3) \_PID\_REV (PID RUN direction setting)

Flag name	Address	IEC type address	Unit	Setting
_PID_REV (PID RUN direction setting)	K1202n	%KX19232 + n	BIT	Available

It sets the RUN direction of PID control of 'n'th loop. For more information about run direction, refer to 7.2.3 PID control parameter setting. If the bit is off, it operates normally; if on, it operates reversely.

## 4) \_PID\_AW2D (Dual Integral accumulation prevention setting)

Flag name	Address	IEC type address	Unit	Setting
_PID_AW2D (dual integral accumulation prevention setting)	K1203n	%KX19248 + n	BIT	Available

It sets enable/disable of dual integral accumulation prevention of 'n'th loop. For more information about dual integral accumulation prevention, refer to 7.2.3 PID control parameter setting. If the bit is off, it is enabled; if on, it is disabled.

## Chapter 5 Built-in PID Function

### 5) \_PID\_REM\_RUN (PID remote operation setting)

Flag name	Address	IEC type address	Unit	Setting
_PID_REM_RUN (PID remote run setting)	K1204n	%KX19264 + n	BIT	Available

XGB series built-in PID function can be started by both run from command's start junction and remote run bit setting. That is, XGB starts PID control if PIDRUN command's start junction is on or remote run setting bit is on. Namely, if one of them is on, it executed PID control.

### 6) \_PID\_PWM\_EN (PWM output enable)

Flag name	Address	IEC type address	Unit	Setting
_PID_PWM_EN (PWM output enable)	K1208n	%KX19328 + n	BIT	Available

It determines whether to output the MV of PID control of 'n'th loop as PWM output. For more information about PWM output, refer to 6.2.3 PID control parameter setting. If the bit is off, it is disabled; if on, it is enabled.

### 7) \_PID\_STD (PID RUN status indication)

Flag name	Address	IEC type address	Unit	Setting
_PID_STD (PID RUN status indication)	K1209n	%KX19344 + n	BIT	Unavailable

It indicates the PID control RUN status of 'n' th loop. If a loop is running or paused, it is on while if it stops or has an error during RUN, it is off. In the area as monitoring area, it is changed to the current run status by PLC although a user enters any value temporarily.

### 8) \_PID\_ALARM (PID Warning occurrence)

Flag name	Address	IEC type address	Unit	Setting
_PID_ALARM (PID Warning occurrence)	K1210n	%KX19360 + n	BIT	Unavailable

It indicates warning if any warning occurs during PID control of 'n'th loop. Once a warning occurs during PID control operation of a loop, it is on while if it is normal, it is off. At the moment, despite of warning, PID control continues without interruption, but it is desirable to check warning information and take a proper measure. Once a warning occurs, the warning code is also indicated in warning code area of a loop. For more information about the types of warning codes and measures, refer to 6.5. In the area as monitoring area, it is changed to the current run status by PLC although a user enters any value temporarily.

### 9) \_PID\_ERROR (PID Error occurrence)

Flag name	Address	IEC type address	Unit	Setting
_PID_ERROR (PID error occurrence)	K1211n	%KX19376 + n	BIT	Unavailable

If an error that discontinues running during PID control of 'n' th loop occurs, it indicates the error's occurrence. If an error



generates warning, it is on; if normal, it is off. When an error occurs, PID control stops and MV is output as the min. output set in parameter. Also, if an error occurs, the error code is indicated in the error code area of a loop. For more information about type of error codes and measures, refer to 6.5. In the area as monitoring area, it is changed to the current run status by PLC although a user enters any value temporarily.

#### 10) \_PID\_MV\_BMPL (PID MV BuMPLess changeover)

Flag name	Address	IEC type address	Unit	Setting
_PID_MV_BMPL (PID MV BuMPLess changeover)	K1212n	%KX19392 + n	BIT	Available

This allows to not only determine an appropriate MV value through operation so that MV can continue smoothly when the corresponding PID loop changes from manual to auto output mode, but also reflect the MV value to the internal state so as to stabilize MV. This function shows an algorithm difference between single operation and cascade operation, but both operations are performed by this bit.

If the corresponding bit (in cascade operation, the corresponding bit of the master/slave loop is On) is On, Bumpless changeover is performed. If it is Off, The [Default] Bumpless changeover function is Disabled

#### (b) PID Flag area by loops

PID flag areas by loops are allocated between K1216 ~ K1855 and for totally 16 loops, each 40 words is allocated per loop.

Therefore, the individual data areas of 'n' th loop are between K (1216+16\*n) ~ K (1255+16\*n). Every setting of the PID flag areas by loops may be changed during PID control operation. Once the settings are changed, they are applied from the next PID control cycle.

#### 1) \_PIDxx\_SV (PID xx Loop SV setting)

Flag name	Address	IEC type address	Unit	Scope
_PIDxx_SV (PID xx Loop SV setting)	K1216+16*xx	%KW1216+16*xx	INT	-32,768 ~ 32,767

It sets/indicates the SV of PID control of 'xx' th loop. For more information about SV, refer to 6.2.3 PID control parameter setting. The available scope is between -32,768 ~ 32,767.

#### 2) \_PIDxx\_T\_s (PID xx Loop operation cycle)

Flag name	Address	IEC type address	Unit	Scope
_PIDxx_T_s (PID xx Loop operation cycle)	K1217+16*xx	%KW1217+16*xx	WORD	100 ~ 65,535

It sets/indicates the operation cycle of PID control of 'xx' th loop. For more information about operation cycle, refer to 6.2.3 PID control parameter setting. The available scope is between 100 ~ 65,535.

#### 3) \_PIDxx\_K\_p (PID xx Loop proportional constant)

Flag name	Address	IEC type address	Unit	Scope
_PIDxx_K_p (PID xx Loop proportional constant)	K1218+16*xx	%KD609+20*xx	REAL	Real number

## Chapter 5 Built-in PID Function

It sets/indicates the proportional constant of PID control of 'xx' th loop. For more information about proportional constant, refer to 7.2.3 PID Control Parameter Setting. The available scope is real number (-3.40282347e+38 ~ -1.17549435e-38 , 0 , 1.17549435e-38 ~ 3.40282347e+38). If it is, however, set as 0 and lower, the PID control of a loop generates an error and does not work.

### 4) \_PIDxx\_T\_i (PID xx Loop Integral time)

Flag name	Address	IEC type address	Unit	Scope
_PIDxx_T_i (PID xx Loop integral time)	K1220+16*xx	%KD610+20*xx	REAL	Real number

It sets/indicates integral time of PID control of 'xx' th loop. The available scope is real number. If it is set as 0 and lower, it does not execute integral control.

### 5) \_PIDxx\_T\_d (PID xx Loop differential time)

Flag name	Address	IEC type address	Unit	Scope
_PIDxx_T_d (PID xx Loop differential time)	K1222+16*xx	%KD611+20*xx	REAL	Real number

It sets/indicates differential time of PID control of 'xx' th loop. The available scope is real number. If it is set as 0 and lower, it does not execute differential control.

### 6) \_PIDxx\_d\_PV\_max (PV change limit)

Flag name	Address	IEC type address	Unit	Scope
_PIDxx_d_PV_max (PV change limit)	K1224+16*xx	%KD612+20*xx	WORD	0 ~ 65,535

It sets the PV change limit of 'xx' th loop.

For more information about PV change limit, refer to 6.2.3 PID control parameter setting. If it is set as 0, the PV change limit function does not work.

### 7) \_PIDxx\_d\_MV\_max (MV change limit)

Flag name	Address	IEC type address	Unit	Scope
_PIDxx_d_MV_max (MV change limit)	K1225+16*xx	%KD610+20*xx	WORD	0 ~ 65,535

It sets the MV change limit of 'xx' th loop. For more information about MV change limit, refer to 6.2.3 PID control parameter setting. If it is set as 0, the MV change limit function does not work.

8) `_PIDxx_MV_max`, `_PIDxx_MV_min`, `_PIDxx_MV_man` (max. MV, min. MV, manual MV)

Flag name	Address	IEC type address	Unit	Scope
<code>_PIDxx_MV_max</code> (max. MV)	K1226+16*xx	%KW1226+16*xx	INT	-32,768 ~ 32,767
<code>_PIDxx_MV_min</code> (min. MV)	K1227+16*xx	%KW K1227+16*xx		
<code>_PIDxx_MV_man</code> (manual MV)	K1228+16*xx	%KW K1228+16*xx		

It sets the max. MV, min. MV and manual MV of 'xx' th loop. For more information about max. MV, min. MV and manual MV, refer to 6.2.3 PID control parameter setting. If the max. MV is set lower than the min. MV, the PID control loop generates an error and does not work.

9) `_PIDxx_PV` (present value)

Flag name	Address	IEC type address	Unit	Scope
<code>_PIDxx_PV</code> (present value)	K1229+16*xx	%KW1229+16*xx	INT	-32,768 ~ 32,767

It is the area that receives the present value of 'xx' th PID control loop. PV is the present status of the system to control and is normally saved into U device via input devices such as A/D input module if it is entered from a sensor. The value is used to execute PID operation by moving to `_PIDxx_PV` by means of commands like MOV.

10) `_PIDxx_PV_OLD` (PV of previous control cycle)

Flag name	Address	IEC type address	Unit	Scope
<code>_PIDxx_PV_OLD</code> (PV of previous control cycle)	K1230+16*xx	%KW1230+16*xx	INT	Unavailable

The area indicates the PV just before the xx th PID control loop. The flag, as a dedicated monitoring flag, would be updated by PLC although a user directly enters it.

11) `_PIDxx_MV` (Control MV)

Flag name	Address	IEC type address	Unit	Scope
<code>_PIDxx_MV</code> (control MV)	K1231+16*xx	%KW1231+16*xx	INT	Unavailable

The area shows the MV of 'xx' th PID control loop. As the area in which XGB built-in PID operation result is output every PID control cycle, it delivers the value in the area to U device every scanning by using commands like MOV in the program and outputs to D/A output module, operating a drive.

## Chapter 5 Built-in PID Function

### 12) \_PID00\_ERR (Present error)

Flag name	Address	IEC type address	Unit	Scope
_PID00_ERR (present error)	K1232+16*xx	%KW1232+16*xx	DINT	Unavailable

The areas shows the current error of 'xx' th PID control loop. It is also used as an indicator about how much gap the present status has with a desired status and if an error is 0, it means the control system reaches a desired status exactly. Therefore, if control starts, error is quickly reduced at transient state and it reaches normal state, maintaining remaining drift as 0, it could be an ideal control system. The flag, as a dedicated monitoring, is updated although a user directly enters it.

### 13) \_PIDxx\_MV\_p, \_PIDxx\_MV\_i, \_PIDxx\_MV\_d (P/I/D control components of MV)

Flag name	Address	IEC type address	Unit	Scope
_PIDxx_MV_p (MV proportional control component)	K1234+16*xx	%KD616+20*xx	REAL	Unavailable
_PIDxx_MV_i (MV integral control component)	K1236+16*xx	%KD617+20*xx		
_PIDxx_MV_d (MV differential control component)	K1238+16*xx	%KD618+20*xx		

It indicates 'n' th loop MV by classifying proportional control MV, integral control max. MV and differential control MV. The entire MV consists of the sum of these three components. The flag, as a dedicated monitoring, is updated although a user directly enters it.

### 14) \_PIDxx\_DB\_W (DeadBand setting)

Flag name	Address	IEC type address	Unit	Scope
_PIDxx_DB_W (DeadBand setting)	K1240+16*xx	%KW1232+16*xx	WORD	0 ~ 65,535

It sets the deadband of 'xx' th loop. For more information about Deadband function, refer to 6.2.3 PID control parameter setting. If it is set as 0, the function does not work.

### 15) \_PIDxx\_Td\_lag (Differential filter coefficient)

Flag name	Address	IEC type address	Unit	Scope
_PIDxx_Td_lag (differential filter coefficient)	K1241+16*xx	%KW1241+16*xx	WORD	0 ~ 65,535

It sets the differential filter coefficient of 'xx' th loop. For more information about differential filter coefficient, refer to 6.2.3 PID control parameter setting. If it is set as 0, the function does not work.

## 16) \_PIDxx\_PWM (PWM output junction setting)

Flag name	Address	IEC type address	Unit	Scope
_PID00_PWM (PWM output junction setting)	K1242+16*xx	%KW1242+16*xx	WORD	H'20 ~ H'3F

It sets the junction to which PWM output of 'xx' th loop is output. PWM output junction is valid only between H'20 ~ H'3F. If any other value is entered, PWM output does not work.

## 17) \_PIDxx\_PWM\_Prd (PWM Output cycle setting)

Flag name	Address	IEC type address	Unit	Scope
_PIDxx_PWM_Prd (PWM output cycle setting)	K1243+16*xx	%KW1243+16*xx	WORD	100 ~ 65,535

It sets the PWM output cycle of 'xx' th loop. The available scope is between 100 ~ 65,535 at the unit of 0.1ms.

## 18) \_PIDxx\_SV\_RAMP (SV ramp setting)

Flag name	Address	IEC type address	Unit	Scope
_PIDxx_SV_RAMP (SV ramp setting)	K1244+16*xx	%KW1244+16*xx	WORD	0 ~ 65,535

It sets the SV ramp value of 'xx' th loop. For more information about SV ramp of PV, refer to 6.2.3 PID control parameter setting. If it is set as 0, the function does not work.

## 19) \_PIDxx\_PV\_Track (PV follow-up setting)

Flag name	Address	IEC type address	Unit	Scope
_PIDxx_PV_Track (PV follow-up setting)	K1245+16*xx	%KW1245+16*xx	WORD	0 ~ 65,535

It sets the PV follow-up SV of 'xx' th loop. For more information about PV follow-up, refer to 6.2.3 PID control parameter setting. If it is set as 0, the function does not work.

## 20) \_PIDxx\_PV\_MIN, \_PIDxx\_PV\_MAX (Min. PV input, Max. PV input)

Flag name	Address	IEC type address	Unit	Scope
_PIDxx_MV_p (MV proportional control component)	K1246+16*xx	%KW1246+16*xx	INT	-32,768 ~ 32,767
_PIDxx_MV_i (MV integral control component)	K1247+16*xx	%KW1247+16*xx		

It sets the min./max. PV of 'xx' th loop.

## 21) \_PIDxx\_ALM\_CODE (Warning code)

Flag name	Address	IEC type address	Unit	Scope
_PIDxx_ALM_CODE (Warning code)	K1248+16*xx	%KW1248+16*xx	WORD	Unavailable

It indicates warning code if a warning occurs during 'xx' th loop run. The flag, as a dedicated monitoring, is updated although a user directly enters it. For more information about warning code, refer to 6.5.

## 22) \_PIDxx\_ERR\_CODE (Error code)

Flag name	Address	IEC type address	Unit	Scope
_PIDxx_ERR_CODE (error code)	K1249+16*xx	%KW1249+16*xx	WORD	Unavailable

It indicates error code if an error occurs during 'xx' th loop run. The flag, as a dedicated monitoring, is updated although a user directly enters it. For more information about warning code, refer to 6.5.

## 23) \_PIDxx\_CUR\_SV (SV of the present cycle)

Flag name	Address	IEC type address	Unit	Scope
_PIDxx_CUR_SV (SV of the present cycle)	K1250+16*xx	%KW1250+16*xx	INT	Unavailable

It indicates SV currently running of 'xx' th loop. If SV is changing due to SV ramp or PV follow-up function, it shows the currently changing PV. The flag, as a dedicated monitoring, is updated although a user directly enters it.

## 5.5 PID Instructions

It describes PID control commands used in XGB series. The command type of PID control used in XGB series built-in PID control is 4.

### (1) PIDRUN

PIDRUN is used to execute PID control by loops.

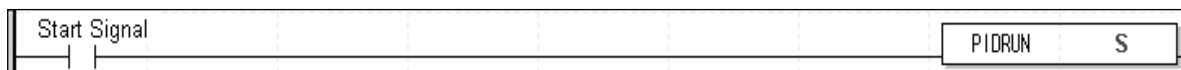

- Operand S means the loop no. to execute PID control and available only for constant(0~15).
- If start signal contact is on, the PID control of a loop starts.

### (2) PIDCAS

PIDCAS is a command to execute CASCADE control.

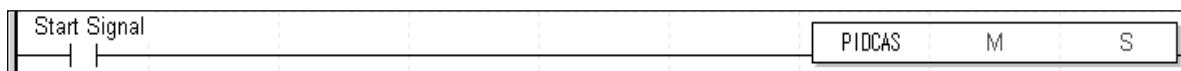

- Operand M and S mean master loop and slave loop respectively and available only for constant(0~15).
- If start signal contact is on, cascade control is executed through master loop and slave loop.

Cascade control is called a control method which is intended to increase control stability through quick removal of disturbance by connecting two PID control loops in series and is structured as follows.

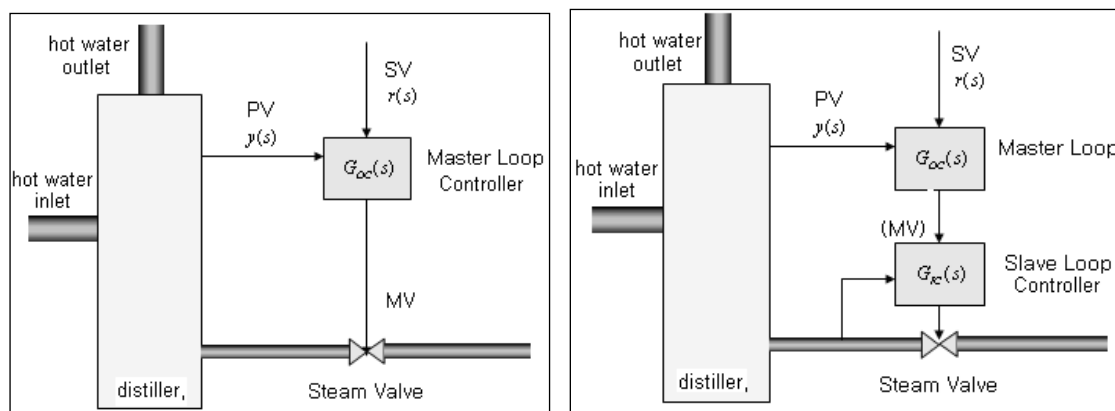

[Figure 6.13 Comparison of single loop control and cascade control]

Looking at the figure, it is found that cascade control contains slave loop control within external control loop. That is, the control output of external loop PID control is entered as SV of the internal loop control. Therefore, if steam valve suffers from disturbance in the figure, single loop PID control may not be modified until PV,  $y(s)$  appears while cascade control is structured to remove any disturbance by the internal PID loop control before any disturbance that occurs in its internal loop affects the PV,  $y(s)$ , so it can early remove the influence from disturbance.

XGB internal PID control connects two PID control loops each other, making cascade control possible. At the moment, MV of external loop is automatically entered as the SV of internal loop, so it is not necessary to enter it through program.

## Chapter 5 Built-in PID Function

### (3) PIDHBD

PIDHBD is a command to execute the mixed forward/reverse E control.

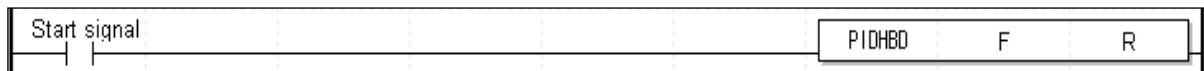

- Operand F and R represent forward operation loop and reverse operation loop and available only for constant(0~15).
- If start signal contact is on, it starts the mixed forward/reverse operation from the designated forward/reverse loops.

The mixed forward/reverse control is called a control method to control forward operation control output and reverse operation control operation alternatively to a single control process. The XGB built-in PID control enables the mixed forward/reverse control by connecting two PID control loops set as forward/reverse operations. At the moment, it uses PIDHBD command. For more information about the command, refer to 6.2.5. The mixed forward/reverse run is executed as follows in the XGB built-in PID control.

#### (a) Commencement of mixed run

If PIDHBD command starts first, it starts reverse run when PV is higher than SV; it starts forward run if PV is lower than SV.

#### (b) Conversion of RUN direction

The conversion of run direction is executed according to the following principles. In case of forward operation run, it keeps running by converting to reverse operation once PV is over SV + DeadBand value. At the moment, the DeadBand setting value uses the deadband of a loop set for forward operation. If PV is below SV - DeadBand value during reverse operation, it also keeps running by converting to forward operation. In the case, the DeadBand setting uses the deadband of a loop set for reverse loop. It may be illustrated as 6.14.

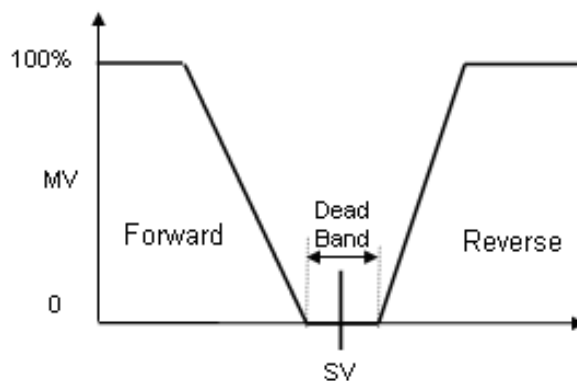

[Figure 6.14 Conversion of RUN direction in the mixed forward/reverse control]

- (c) At the moment, every control parameter uses the parameter of a loop set for forward operation while MV is output to MV output area of a loop of forward operation. Reversely, every control parameter uses the parameter of a loop set for reverse operation during reverse operation run while MV is also output to MV output area of reverse operation loop.



## 5.6 PID Auto-tuning

### 5.6.1 Basic Theory of PID Auto-tuning

It describes the function of PID auto-tuning.

The performance of PID controller is very different according to P, I, D coefficient. Generally, It is very difficult and takes long time to predict the system and set P, I, D coefficient because of non-periodical disturbance, interference of other control loop, dynamic characteristic of control system though the engineer is good at handling the PID controller. So auto-tuning that sets the PID coefficient automatically is very useful. Generally, there are many methods in setting the PID coefficient. Here, it will describe Relay Auto-tuning.

#### (1) PID coefficient setting by Relay auto-tuning

It makes critical oscillation by force and uses the width and period of oscillation to specify the PID coefficient. It applies max. output and min. output to control system for auto-tuning. Then, oscillation with steady period and steady width occurs around the Set value like figure 6.15, and it can calculate the boundary gain by using it like expression (6.3.1).

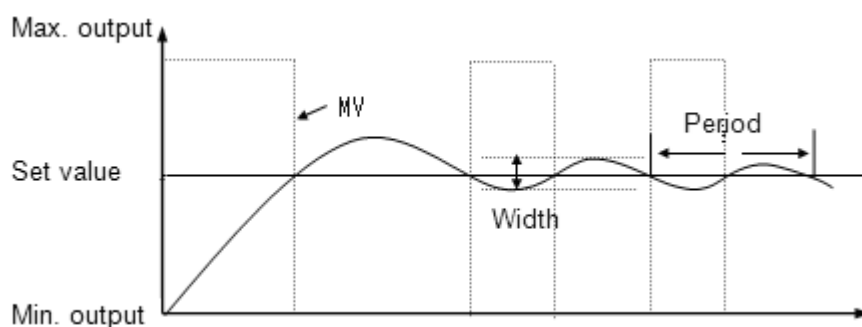

< Figure 6.15 Relay auto-tuning >

$$K_u = \frac{4 \times (\text{Max.output} - \text{Min.output})}{\pi \times \text{width}} \quad (6.4.1)$$

At this time, oscillation period is called boundary period. If boundary gain and period is specified, use table 6.9, Ziegler & Nichols tuning table to specify the PID coefficient. This Relay tuning is relatively simple to configure and easy to know the boundary gain and period so it is used frequently and XGB built-in PID auto-tuning uses this method.

Controller	Proportional gain (Kp)	Integral time(Ti)	Differential time(Td)
P	$0.5K_u$	-	-
PI	$0.45K_u$	$P_u / 1.2$	-
PID	$0.6K_u$	$P_u / 2$	$P_u / 8$

< Table 6.9 Ziegler & Nichols tuning table >

### 5.6.2 PID Auto-tuning Function Specifications

The specifications of the XGB series built-in PID auto-tuning function are summarized as in Table.

Item		Specifications
Scope of SV		INT (-32,768 ~ 32,767)
Scope of PV		INT (-32,768 ~ 32,767)
Scope of MV		INT (-32,768 ~ 32,767)
Error indication		Normal: error flag off Error: error flag off, error code occurs
AT direction setting		Forward/Reverse
Control cycle		100 ~ 65,536 (0.1msUnit)
Additional function	PWM output	Supportable
	Hysteresis	Supportable

[Table 6.10 Spec. of built-in PID auto-tuning function]

### 5.6.3 Auto-tuning Parameter Setting

To use the XGB series auto-tuning function, it is necessary to start it by using a command after setting auto-tuning parameters by loops in the parameter window. It explains the parameters to use auto-tuning function and how to set them.

(1) Auto-tuning parameter setting

To set the parameters of XGB series auto-tuning function, follow the steps.

- (a) If selecting parameter in project window and the built-in parameter, it shows the built-in parameter setting window as seen in below figure.

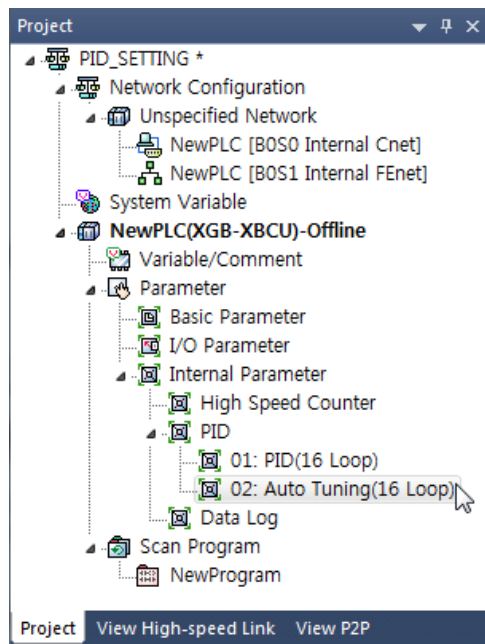

< Figure 6.16 Built-in parameter setting window >

(b) If selecting auto-tuning, it shows the parameter setting window as seen in Figure 6.17.

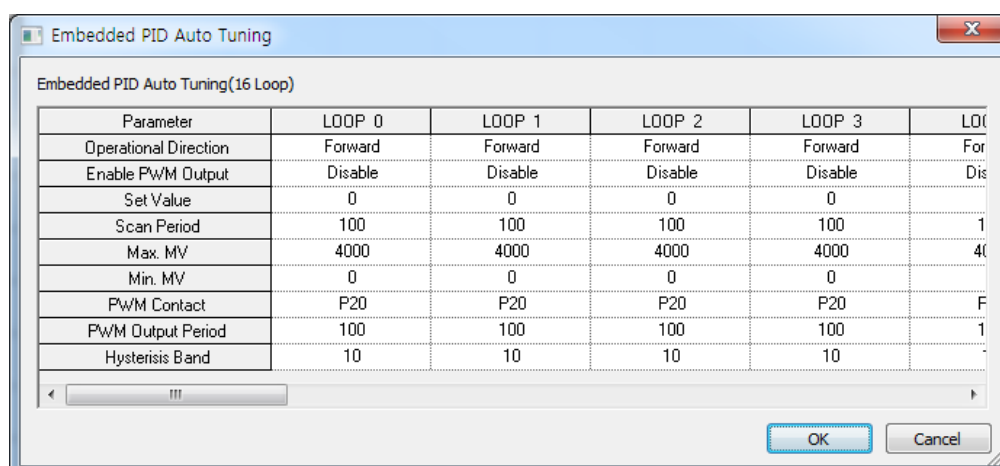

<Figure 6.17 Built-in auto-tuning function parameter setting window>

(c) Input items

Table shows the items to set in auto-tuning parameter window and the available scopes.

Items	Description	Scope
RUN direction	Set the run direction of auto-tuning.	Forward/reverse
PWM output enable	Set whether to set PWM output of MV enabled/disabled.	Disable/enable
SV	Set SV.	-32,768 ~ 32,767
Operation time	Set auto-tuning operation time.	100 ~ 65535
Max. MV	Set the max. MV in control.	-32,768 ~ 32,767
Min. mV	Set the min. MV in control.	-32,768 ~ 32,767
PWM junction designation	Designate the junction to which PWM output is output.	P20 ~ P3F
PWM output cycle	Set the output cycle of PWM output.	100 ~ 65,535
Hysteresis setting	Set the hysteresis of auto-tuning MV.	0 ~ 65,535

< Table 6.11 Auto-tuning function parameter setting items>

(2) Description of auto-tuning parameters and how to set them

(a) RUN direction

RUN direction is to set the direction of auto-tuning run of a loop. The available option is forward or reverse. The former (forward) means that PV increase when MV increases while the latter (reverse) means PV decreases when MV increases. For instance, a heater is a kind of forward direction system because PV (temperature) increases when output (heating) increases. A refrigerator is a kind of reverse direction system in which PV (temperature) decreases when output increases.

(b) PWM output enable

PWM output means an output method to turn a junction on – off with a duty proportional to control output calculated by a uniform output cycle. If PWM output is enabled, it realizes PWM output in accordance with PWM output cycle set in the parameter of PWM output junction (P20 ~ P3F) designated in the parameter. At the moment, the PWM output cycle follows the PWM output cycle separately set in auto-tuning operation cycle.

## (c) SV

It sets the auto-tuning SV of a loop in question. Similar to PID control, physical values (temperature, flow rate, pressure and etc) of an object to control is not meaningful and instead, it should use the physical amount of an object to control after converting them into numerals. For instance, in order to control a system using a sensor that the output is 0V when its heating device temperature is 0°C while it is 10V when the temperature is 100°C as much as 50°C, it is necessary to set SV as 2000(as long as it uses AD input module XBE-AD04A).

## (d) Operation time

It sets the cycle to execute operation for auto-tuning. The setting cycle is 0.1ms and available between 10ms ~ 6553.5ms (setting value: 100 ~ 65,535) while it is set at a unit of integer per 0.1ms.

## (e) Max./min. MV

It sets the max./min. value of output for auto-tuning. The available scope is between -32,768 ~ 32,767. If the max. MV is set lower than min. MV, the auto-tuning function of a loop generates an error and does not work.

## (f) Hysteresis setting

Looking at relay tuning in Figure 6.15, it shows it outputs the max. MV as auto-tuning starts but it converts to min. output as PV is over SV and then, it converts to the max. output as PV is lower than SV. However, if input PV contains noise components or reply components, auto-tuning ends by a slight vibration of PV around SV, yielding incorrect tuning result. To prevent it, hysteresis may be set. XGB auto-tuning converts output at SV + Hysteresis when PV increases or at SV - Hysteresis when it decreases once hysteresis is set. With it, it may prevent incorrect tuning by a slight vibration around SV.

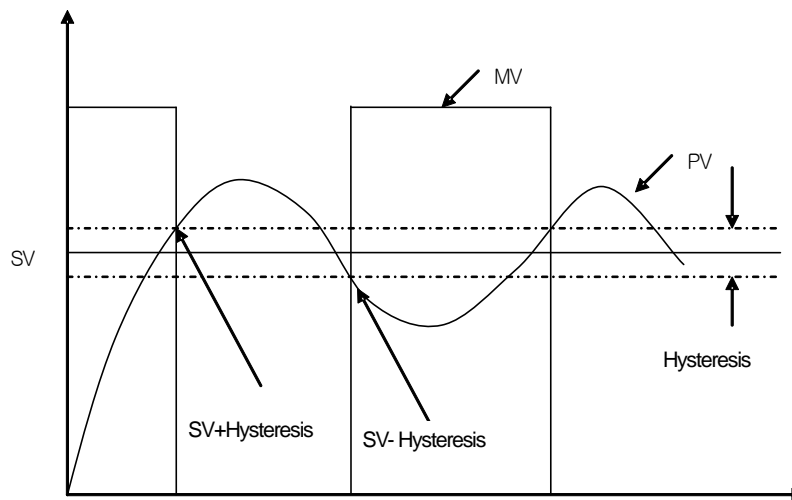

[Figure 6.16 Example of Hysteresis setting ]

## 5.6.4 Auto-tuning Flags

The parameters set in the XGB series auto-tuning function are saved to the flash memory of basic unit. Such parameters are moved to K area for auto-tuning function as soon as PLC enters to RUN mode from STOP. Auto-tuning operation using auto-tuning command is achieved by data in K area. At the moment, if PLC is changed to RUN again after being changed to STOP, it takes the parameters in flash memory to K area, so the data changed in K area is lost. Therefore, to continuously apply the parameters adjusted in K area, it is necessary to write the parameters set in K area into flash memory by using WRT command. (In case of IEC type, APM\_WRT function block)

### (1) Auto-tuning flag configuration

The K area flags of XGB series auto-tuning function are summarized in Table 6.12.

Loops	K area	IEC type	Symbol	Data type	Default	Description
Common	K18560~F	%KX29696 ~%KX29711	_AT_REV	Bit	Forward	Auto-tuning direction(0:forward, 1:reverse)
	K18570~F	%KX29712 ~%KX29727	_AT_PWM_EN	Bit	Disable	PWM output enable(0:disable, 1:enable)
	K18580~F	%KX29728 ~%KX29743	_AT_ERROR	Bit	-	Auto-tuning error(0:normal,1:error)
	K1859	%KW1859	Reserved	WORD	-	Reserved area
Loop0	K1860	%KW1860	_AT00_SV	INT	0	AT SV – loop 00
	K1861	%KW1861	_AT00_T_s	WORD	100	AT operation cycle (T_s)[0.1msec]
	K1862	%KW1862	_AT00_MV_max	INT	4000	AT MV max. value limit
	K1863	%KW1863	_AT00_MV_min	INT	0	AT MV min. value limit
	K1864	%KW1864	_AT00_PWM	WORD	0	AT PWM junction setting
	K1865	%KW1865	_AT00_PWM_Prd	WORD	0	AT PWM output cycle
	K1866	%KW1866	_AT00_HYS_val	WORD	0	AT hysteresis setting
	K1867	%KW1867	_AT00_STATUS	WORD	0	AT auto-tuning status indication
	K1868	%KW1868	_AT00_ERR_CODE	WORD	0	AT error code
	K1869	%KD	_AT00_K_p	REAL	0	AT result proportional coefficient
	K1871	-	_AT00_T_i	REAL	0	AT result integral time
	K1873	-	_AT00_T_d	REAL	0	AT result differential time
	K1875	-	_AT00_PV	INT	0	AT PV
	K1876	-	_AT00_MV	INT	0	AT MV
K1877~1879	%KW1877 ~%KW1879	Reserved	Word	0	Reserved area	

[Table 6.12 K area flags for auto-tuning]

K1856 ~ K1859 areas (In case of IEC type, %KW1856~%KW1859) are the common bit areas for auto-tuning and each bit represents auto-tuning loop status respectively. K1860~K1879 areas save the setting and status of loop 0 as the K area for auto-tuning loop 0. In the area, the parameters such as PV, operation cycle and etc set in the built-in parameter window are saved and the XGB built-in auto-tuning function executes auto-tuning by the device values and saves the results into the K areas.

## Chapter 5 Built-in PID Function

### (2) Auto-tuning flag function

Each function of K area flags for XGB series auto-tuning is summarized as follows.

#### A) Common bit area

The area is a flag collecting operation setting and information consisting of bits to each 16 loop. Each bit of each word device represents the information of each loop.

##### 1) `_AT_REV` (auto-tuning run direction setting)

Flag name	Address	IEC type address	Unit	Setting
<code>_AT_REV</code> (PID RUN direction setting)	K1856n	%KX29696 + n	BIT	Available

It determines the run direction of auto-tuning of 'n' th loop. If the bit is off, it is forward operation; if on, it is reverse operation.

##### 2) `_AT_PWM_EN` (PWM output enable)

Flag name	Address	IEC type address	Unit	Setting
<code>_AT_PWM_EN</code> (PWM output enable)	K857n	%KX29713 + n	BIT	Available

It sets whether to output the auto-tuning MV of 'n' th loop as PWM output. If the bit is off, it is disabled; if on, it is enabled.

##### 3) `_AT_ERROR` (Auto-tuning error occurrence)

Flag name	Address	IEC type address	Unit	Setting
<code>_PID_ERROR</code> (PID error occurrence)	K1858n	%KX29728 + n	BIT	Unavailable

It indicates the error in case an error that discontinues operation during auto-tuning of 'n' th loop occurs. If an error occurs, it is on; if normal, it is off. Once an error occurs, auto-tuning stops and the MV is output as the min. output set in the parameter. Also, if an error occurs, it indicates the error code in the error code area of a loop. For more information about error code types and measures, refer to 6.5. The area, as a dedicated monitor area, is updated although a user directly enters it.

#### B) Auto-tuning flag area by loops

The auto-tuning flag areas by loops are K1860 ~ K2179 and each 20 words per loop are allocated to totally 16 loops. Therefore, individual data area of 'n' th loop is between K (1860+16\*n) ~ K (1879+16\*n).

##### 1) `_ATxx_SV` (auto-tuning xx Loop SV setting)

Flag name	Address	IEC type address	Unit	Scope
<code>_ATxx_SV</code> (AT xx Loop SV setting)	K1860+16*xx	%KW1860+16*xx	INT	-32,768 ~ 32,767

It sets/indicates the auto-tuning SV of 'xx' th loop.  
The available scope is between -32,768 ~ 32,767.

2) `_ATxx_T_s` (Auto-tuning xx Loop operation cycle)

Flag name	Address	IEC type address	Unit	Scope
<code>_PIDxx_T_s</code> (Auto-tuning xx Loop operation cycle)	K1861+16*xx	%KW1861+16*xx	WORD	100 ~ 65,535

It sets/indicates the operation cycle of 'xx' th loop auto-tuning. The available scope is 100 ~ 65,535.

3) `_ATxx_MV_max`, `_ATxx_MV_min`(max. MV, min. MV)

Flag name	Address	IEC type address	Unit	Scope
<code>_PIDxx_MV_max</code> (Max. MV)	K1862+16*xx	%KW1862+16*xx	INT	-32,768 ~ 32,767
<code>_PIDxx_MV_min</code> (Min. MV)	K1863+16*xx	%KW1863+16*xx		

It sets max. MV and min. MV of 'xx' th loop respectively. If the max. MV is set lower than min. MV, the auto-tuning loop generates an error and does not work.

4) `_ATxx_PWM` (AT output junction setting)

Flag name	Address	IEC type address	Unit	Scope
<code>_AT00_PWM</code> (AT output junction setting)	K1864+16*xx	%KW1864+16*xx	WORD	H'20 ~ H'3F

It sets the junction that PWM output of 'xx' th loop is output. The PWM output junction is valid only between H'20 ~ H'3F (hex). If any other value is entered, PWM output does not work.

5) `_ATxx_PWM_Prd` (PWM output cycle setting)

Flag name	Address	IEC type address	Unit	Scope
<code>_ATxx_PWM_Prd</code> (PWM output cycle setting)	K1865+16*xx	%KW1865+16*xx	WORD	100 ~ 65,535

It sets the PWM output cycle of 'xx' th loop. The available scope is between 100 ~ 65,535 at the unit of 0.1ms.

6) `_ATxx_HYS_val` (Hysteresis setting)

Flag name	Address	IEC type address	Unit	Scope
<code>_ATxx_HYS_val</code> (Hysteresis setting)	K1866+16*xx	%KW1866+16*xx	WORD	0 ~ 65,535

It sets the hysteresis of 'xx' th loop. For more information about hysteresis function, refer to 6.3.3 Auto-Tuning Parameter Setting. If it is set as 0, it does not work.

## Chapter 5 Built-in PID Function

### 7) \_ATxx\_STATUS (Auto-tuning status)

Flag name	Address	IEC type address	Unit	Scope
_ATxx_STATUS (Auto-tuning status)	K1867+16*xx	%KW1867+16*xx	WORD	Unavailable

It indicates the auto-tuning status of 'xx' th loop. If auto-tuning is in operation, it is 1(h0001); if completed, it is 128(h0080). In any other cases, it shows 0(h0000).

### 8) \_ATxx\_ERR\_CODE (Error code)

Flag name	Address	IEC type address	Unit	Scope
_ATxx_ERR_CODE (Error code)	K1868+16*xx	%KW1868+16*xx	WORD	Unavailable

It indicates error code in case an error occurs during the auto-tuning of 'xx'th loop. The flag, as a dedicated monitor, is updated although a user directly enters it. For more information about error code, refer to 6.5.

### 9) \_ATxx\_K\_p, \_ATxx\_T\_i, \_ATxx\_T\_d (AT result proportional coefficient, integral time, differential time)

Flag name	Address	IEC type address	Unit	Scope
_ATxx_K_p (proportional coefficient)	K1869+16*xx	%KD934+20*xx	Real	Unavailable
_ATxx_T_i (integral time)	K1871+16*xx	%KD1004+20*xx		
_ATxx_T_d (differential time)	K1873+16*xx	%K1005+20*xx		

The area indicates proportional coefficient, integral time and differential time calculated after the auto-tuning of 'xx' th loop is normally completed. The flag, as a dedicated monitoring, updated although a user directly enters it.

### 10) \_ATxx\_PV (PV)

Flag name	Address	IEC type address	Unit	Scope
_ATxx_PV (PV)	K1875+16*xx	%KW1875+16*xx	INT	-32,768 ~ 32,767

It is the area to receive PV of 'xx' th auto-tuning loop. PV is the present status of a system to control and in case of PID control, the entry from a sensor is saved into U device through input devices such as A/D input module and it moves the value to \_ATxx\_PV by using commands such as MOV every scanning, executing auto-tuning.

### 11) \_ATxx\_MV (Auto-tuning MV)

Flag name	Address	IEC type address	Unit	Scope
_ATxx_MV (auto-tuning MV)	K1876+16*xx	%KW1876+16*xx	INT	Unavailable

It is the area to output MV of 'xx' th auto-tuning loop. Every auto-tuning cycle, it saves XGB auto-tuning and it delivers the value in the area by using commands like MOV in a program and operates a drive every scanning.



### 5.6.5 Auto-tuning Instructions

The commands used in XGB series auto-tuning are as follows.

#### 1) PIDAT

PIDAT is a command to execute auto-tuning by loops.

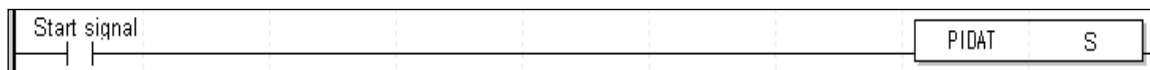

- Operand S means the loop no. to execute auto-tuning and available only for constant(0~15).
- If start signal contact is on, the PID control of a loop starts.

## 5.7 Example Programs

The paragraph explains example programs regarding the directions of XGB built-in PID function. The example programs are explained with water level system as illustrated in 6.17.

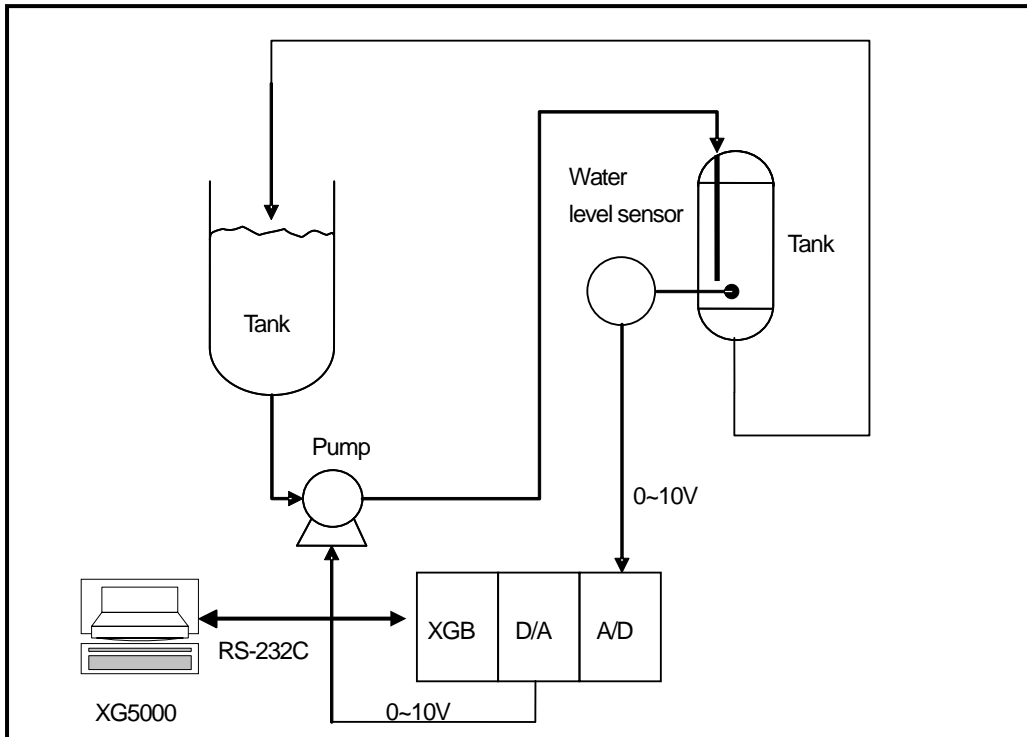

[ Figure 6.17 Example of water level control system ]

### 5.7.1 Example System Structure

The example system in figure is an example of a system to control a pail's water level to a desired level. The pail's water level is sensed by a water level sensor and entered to A/D input module while PID control operation result, MV is output to a pump through D/A output module, controlling a pump's rotation velocity, regulating the water amount flowing into a pail and regulating the water level as desired. Each mechanism is explained as follows.

(1) XGB basic unit

The XGB basic unit operates by PID control operating PID control operation. It receives PV from A/D input module (XBF-AD04A), executes the built-in PID control operation, output the MV to D/A (XBF-DV04A) and executes PID control.

(2) A/D input module (XBF-AD04A)

It functions as receiving PV of an object to control from a water level sensor and delivering it to basic unit. XBF-AD04A is a 4CH analog input module and settings of analog input types and scopes can be changed in the I/O parameter setting window appeared when selecting I/O parameter in the parameter item of project window. For more information, refer to Analog I/O Module.

(3) D/A output module (XBF-DV04A)

It functions as delivering control MV from basic unit to a drive (pump). XBF-DV04A is a 4CH analog voltage output module and ranges 0 ~ 10V. For detail setting, refer to Analog I/O Module.

## (4) Water Level Sensor

A water level sensor plays a role to deliver the PV of an object to control to XGB by measuring the water level of a pail and outputting it within 0 ~ 10V. Since the types and output scope of water level sensors varies, the output scope of a sensor should be identical with that of A/D input module's input scope. The example uses a water level sensor outputting between 0 ~ 10V.

## (5) Drive (pump)

A drive uses a pump that receives control output of XGF-DV04A and of which rotation velocity is variable. For accurate PID control, the output scope of XBF-DV04A (0~10V) should be same with that of a pump's control input. The example uses a pump that receives its control input between 0 ~ 10V.

## 5.7.2 Example of PID Auto-tuning

Here, with examples, it explains how to calculate proportional constant, integral time and differential time by using PID auto-tuning function

## (1) PID auto-tuning parameter setting

- (a) If double-clicking Parameter – Built-in Parameter – PID – Auto-tuning parameter in the project window, it opens up the auto-tuning parameter setting window as illustrated in Figure 6.18.

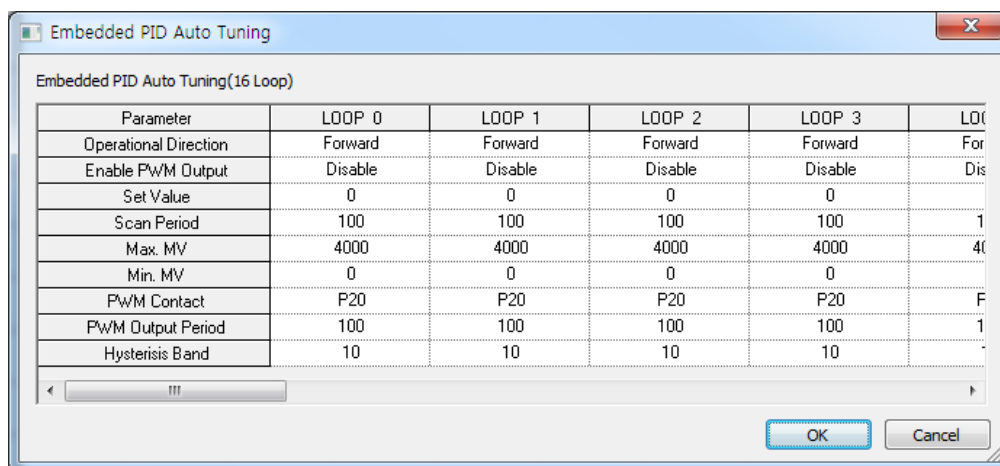

[Figure 6.18 Auto-tuning parameter setting window]

- (b) Set each parameter and click OK.

In the example, Loop 0 is set as follows.

- RUN direction: forward
  - Since in the system, water level is going up as MV increases and pump's rotation velocity increases, it should be set as forward operation.
- PWM output: disabled
  - In the example, auto-tuning using PWM is not executed. Therefore, PWM output is set as disabled.
- SV: 1000(2.5V)
  - It shows an example in which XBF-AD04A is set as the voltage input of 0~10V.

## Chapter 5 Built-in PID Function

- Max. MV: 4000  
- Max. MV is set as 4000. If MV is 4000, XBF-DV04A outputs 10V.
- Min. MV: 0  
- Min. MV is set as 0. If MV is 0, XBF-DV04A outputs 0V.
- PWM junction, PWM output cycle  
- It is not necessary to set it because the example does not use PWM output.
- Hysteresis setting: 10

### (2) A/D input module parameter setting

- (a) If double-clicking Parameter – I/O parameter, it opens up the setting window as illustrated in figure 6.19.

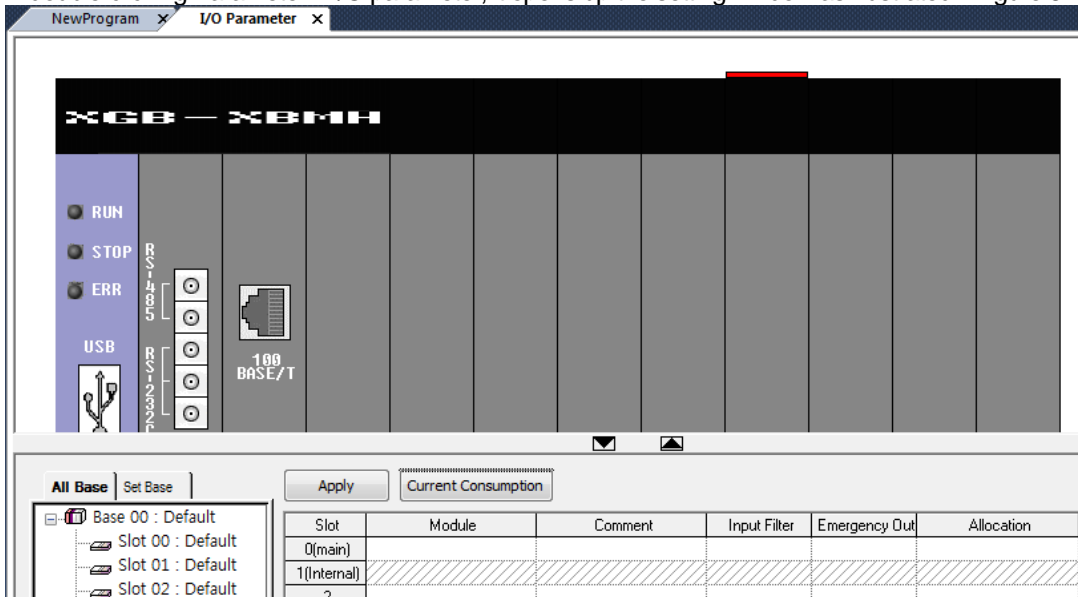

[ Figure 6.19 I/O parameter setting window ]

- (b) If selecting A/D module for a slot in A/D input module, it opens up the setting window as illustrated in Figure 6.20.

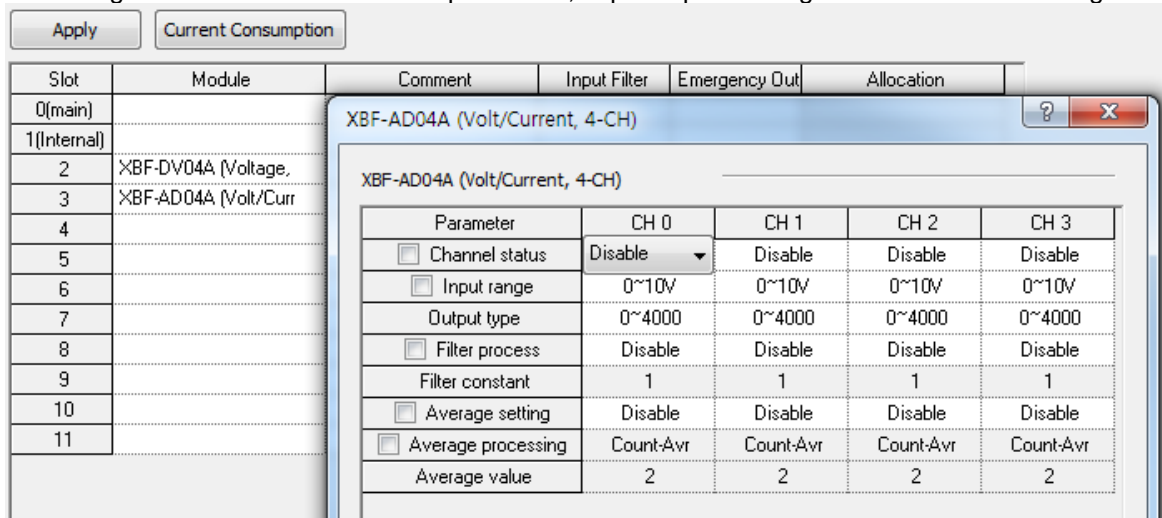

[ Figure 6.20 A/D input mode setting window ]

(c) Check A/D Module operation parameter and click OK. The example is set as follows.

- RUN CH: CH0 RUN
  - The example receives the water level sensor input as CH0.
- Input scope: 0 ~ 10V
  - Set XBF-AD04A input scope as 0 ~ 10V so that it should be identical with the output scope of water level sensor.
- Output data type: 0 ~ 4000
  - It converts the input 0 ~ 10V to digital value from 0 ~ 4000 and delivers it to basic unit.
  - In the case, the resolving power of digital value 1 is  $10/4000 = 2.5\text{mV}$
- Filter process, averaging: disabled
  - The example sets the input values in order that filter process and averaging are not available.
  - For more information about each function, refer to 12 Analog I/O Module.

### (3) D/A Output Module Parameter setting

- (a) Set the parameter of D/A output module(XBF-DV04A) that output MV to a drive.  
How to set them is as same as A/D input module. In the example, it is set as follows.

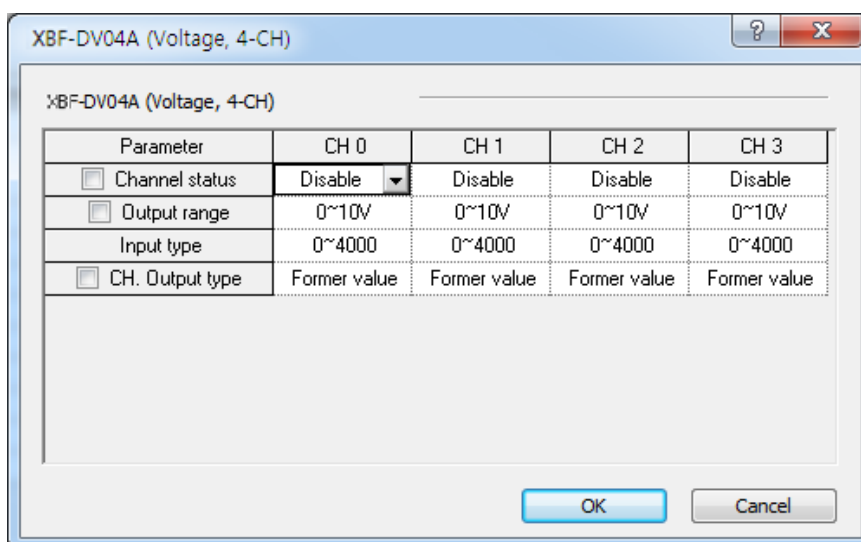

- RUN CH: CH0 RUN
  - In the example, MV is output as CH0 of D/A output module.
- Output scope : 0 ~ 10V
- Input data type: 0 ~ 4000

## Chapter 5 Built-in PID Function

## (4) Example of PID Auto-tuning program

The example of PID auto-tuning program is illustrated as Figure 6.21.

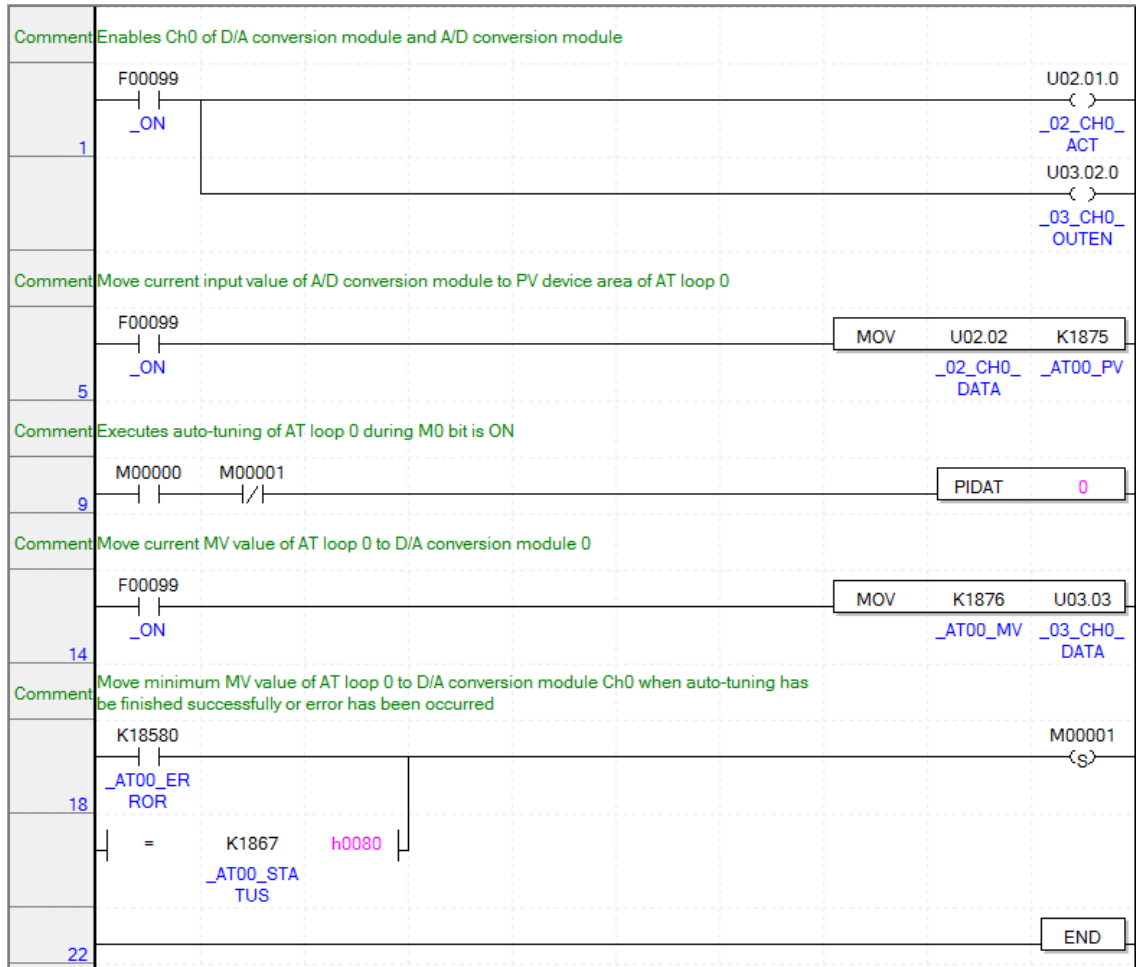

< Figure 6.21 Auto-tuning example program >

## (a) Devices used

Device	Data type	Application
F0099	BIT	It is always on, so it readily operates once PLC is RUN.
U02.01.0	BIT	It starts operation of CH0 of Slot 2 A/D input module.
U03.02.0	BIT	It starts operation of CH0 of Slot 3 D/A output module.
U02.02	INT	PV entered to A/D input module.
U03.03	INT	MV entered to D/A output module.
K1875	INT	Device to which PV is entered for LOOP 0 auto-tuning
K1876	INT	Device to which auto-tuning MV of LOOP 0 is output.
K1867	WORD	Device to which auto-tuning status indicates.
K18580	BIT	Junction that is on once auto-tuning has an error.
K1863	INT	Min. MV of auto-tuning designated in parameter.

## (b) Program explanation

- 1) Since F0099(always on) is ON if PLC is converted form STOP to RUN, CH0 of A/D and D/A starts operating.
- 2) At the moment, PV entered to CH0 of A/D is moved to K1875, the input device of PV and saved accordingly.

- 3) Once M0000 junction is on, the auto-tuning of loop 0 starts.
  - 4) The auto-tuning MV of loop 0 that is output by PIDAT command is output to D/A output module by line 14 MOV command.
  - 5) If auto-tuning is complete or there is any error during auto-tuning, M0001 junction is set, blocking operation of PIDAT command and it outputs min. MV set in parameter to D/A output module.
- (c) Monitoring and changing PID control variables using K area
- In XGB series built-in auto-tuning, it can monitor and change RUN status of auto-tuning by using K area allocated as fixed area by loops.

#### 1) Variable registration

If selecting “Register in Variable/Description” by right clicking in the variable monitor window, “Variable/Device Selection” window appears. Select “Item” as PID, deselect “View All” and enter 0(means loop number) in “Parameter No”, K area device list to save every setting and status of loop 0 appears as shown Figure 6.22. Then, if selecting a variable to monitor and clicking “OK”, a selected device is registered to variable monitor window as illustrated in Figure 6.23. Through the monitor window, a user can monitor auto-tuning run status or change the settings.

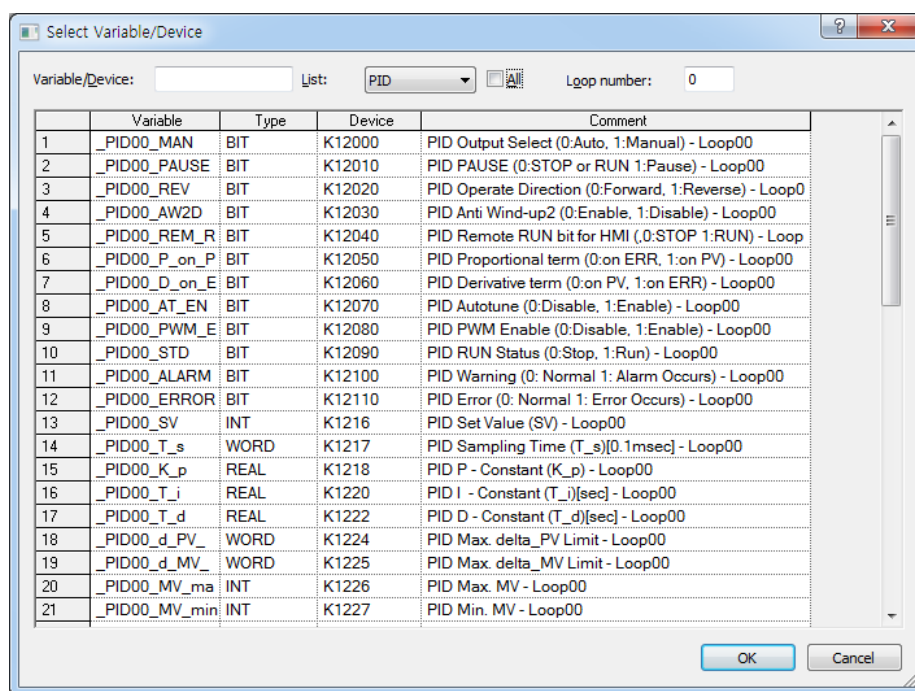

[Figure 6.22 Variable registration window]

## Chapter 5 Built-in PID Function

Monitor 1							
	PLC	Program	Device/Variable	Value	Type	Variable/Device	Comment
1	NewPLC	<GLOBAL>	K12000	<a href="#">10</a>	BIT	._PID00_MAN	PID Output Select (0:Auto, 1:Manual) - Loop00
2	NewPLC	<GLOBAL>	K12010	<a href="#">10</a>	BIT	._PID00_PAUSE	PID PAUSE (0:STOP or RUN 1:Pause) - Loop00
3	NewPLC	<GLOBAL>	K12020	<a href="#">10</a>	BIT	._PID00_REV	PID Operate Direction (0:Forward, 1:Reverse) - Loop00
4	NewPLC	<GLOBAL>	K12030	<a href="#">10</a>	BIT	._PID00_AW2D	PID Anti Wind-up2 (0:Enable, 1:Disable) - Loop00
5	NewPLC	<GLOBAL>	K12040	<a href="#">10</a>	BIT	._PID00_REM_RUN	PID Remote RUN bit for HMI (0:STOP 1:RUN) - Loop00
6	NewPLC	<GLOBAL>	K12050	<a href="#">10</a>	BIT	._PID00_P_on_PV	PID Proportional term (0:on ERR, 1:on PV) - Loop00
7	NewPLC	<GLOBAL>	K12060	<a href="#">10</a>	BIT	._PID00_D_on_ERR	PID Derivative term (0:on PV, 1:on ERR) - Loop00
8	NewPLC	<GLOBAL>	K12070	<a href="#">10</a>	BIT	._PID00_AT_EN	PID Autotune (0:Disable, 1:Enable) - Loop00
9	NewPLC	<GLOBAL>	K12080	<a href="#">10</a>	BIT	._PID00_PWM_EN	PID PWM Enable (0:Disable, 1:Enable) - Loop00

[Figure 6.23 Auto-tuning variables registered]



## (5) Observing RUN status by using trend monitor function

Since it is possible to monitor the operation status of XGB series built-in auto-tuning graphically, it is useful to monitor the operation status of auto-tuning clearly.

(a) If selecting Monitor – Trend monitor menu, it shows the trend monitor window as illustrated in Figure 6.24.

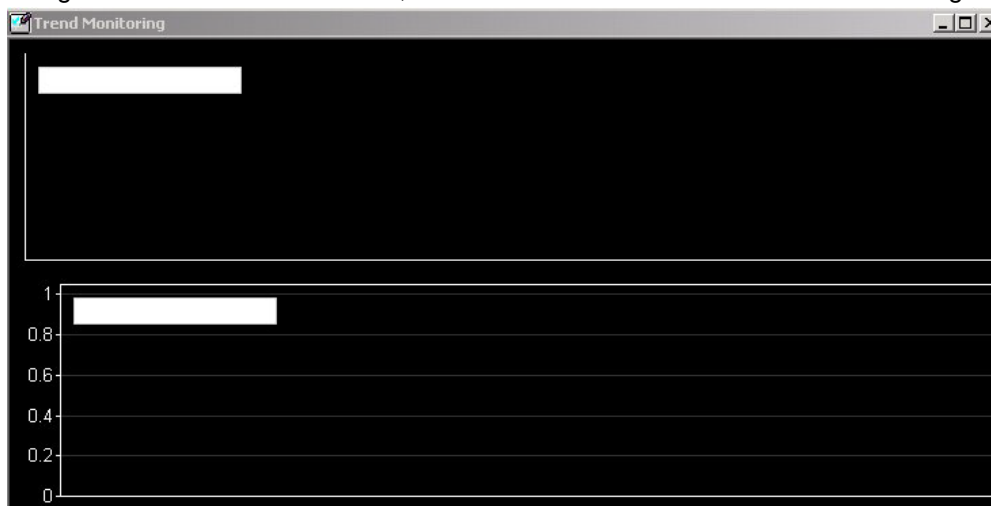

[ Figure 6.24 Trend Monitor window ]

(b) If right-clicking trend setting, a user can select a variable to monitor as illustrated in Figure 6.25.

ID	Device	Variable Name	Type
1			

[ Figure 6.25 window to register trend monitor variable ]

(c) For more information about trend monitor, refer to “XG5000 Use’s Manual.”

### 5.7.3 Stand-alone Operation After PID Auto-tuning

Here, with example, it explains how to execute PID control followed by PID auto-tuning.

(1) PID auto-tuning parameter setting

- PID auto-tuning parameters are set as same as examples of 6.4.2 Example of PID Auto-tuning.

(2) Setting parameters of A/D input module and D/A output module

- Set the parameters of A/D input module and D/A output module as same as the example in 6.4.2 Example of PID Auto-tuning.

(3) PID parameter setting

- (a) If double-clicking Parameter – Built-in Parameter – PID – PID Parameter, it shows the built-in PID parameter setting window as seen in Figure 6.26.

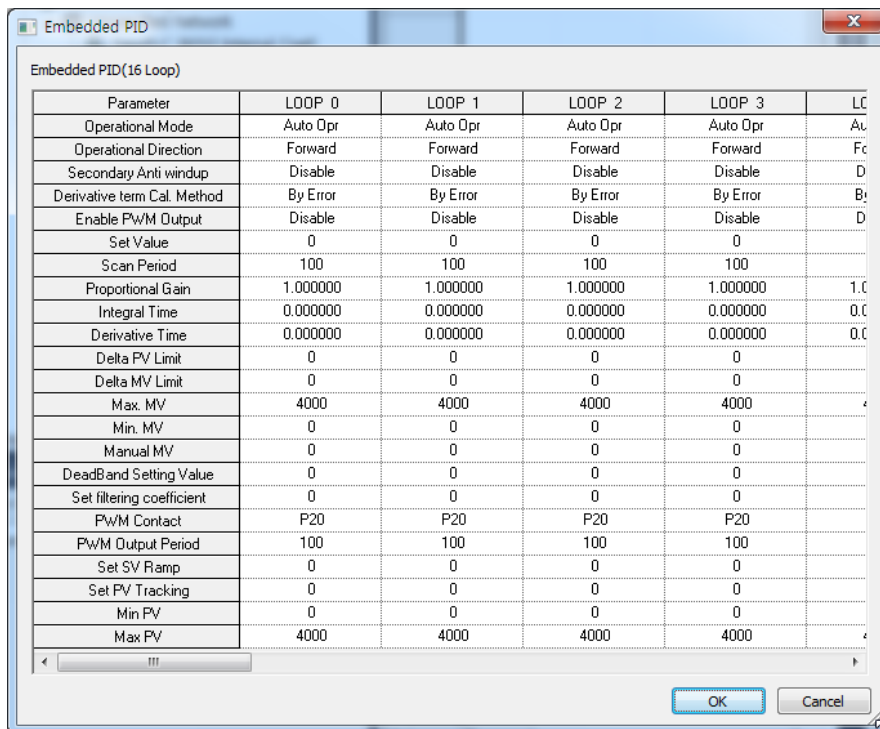

[ Figure 6.26 Auto-tuning parameter setting window ]

(b) Set each parameter and click OK.

In the example, Loop 0 is set as follows.

- RUN mode: automatic
  - Set as automatic in order that PID control is executed as the built-in PID operation outputs MV.
- RUN direction: forward
  - Since in the system, water level is going up as MV increases and pump's rotation velocity increases, it should be set as forward operation.
- PWM Output: disabled
  - In the example, auto-tuning using PWM is not executed. Therefore, PWM output is set as disabled.

- SV: 1000(2.5V)
  - It shows an example in which XBF-AD04A is set as the voltage input of 0~10V
- Operation cycle: 1000
  - In the example, it is set that PID control is executed every 100ms.
- Proportional gain, integral time and differential time
  - It should be initially set as 1,0,0 because PID auto-tuning results is used with PID constant.
- Max. MV: 4000
  - Max. MV is set as 4000. If MV is 4000, XBF-DV04A outputs 10V.
- DeadBand: 0
  - It is set as 0 because the example does not use DeadBand function.
- Differential filter setting: 0
  - it is also set as 0 because the example does not use differential filter.
- Min. MV: 0
  - Min. MV is set as 0. If MV is 0, XBF-DV04A outputs 0V.
- PWM junction, PWM output cycle
  - It is not necessary to set them because the example does not use PWM output.
- SV ramp, PV follow-up: 0
  - It is not necessary to set SV ramp and PV follow-up because the example does not use them.
- Min. PV, Max. PV: 0
  - Set them as 0 and 4000 respectively so that it could be identical with A/D input module's input scope.

## Chapter 5 Built-in PID Function

(c) Example of PID control program after PID auto-tuning

The program example for PID auto-tuning is illustrated as Figure 6.27.

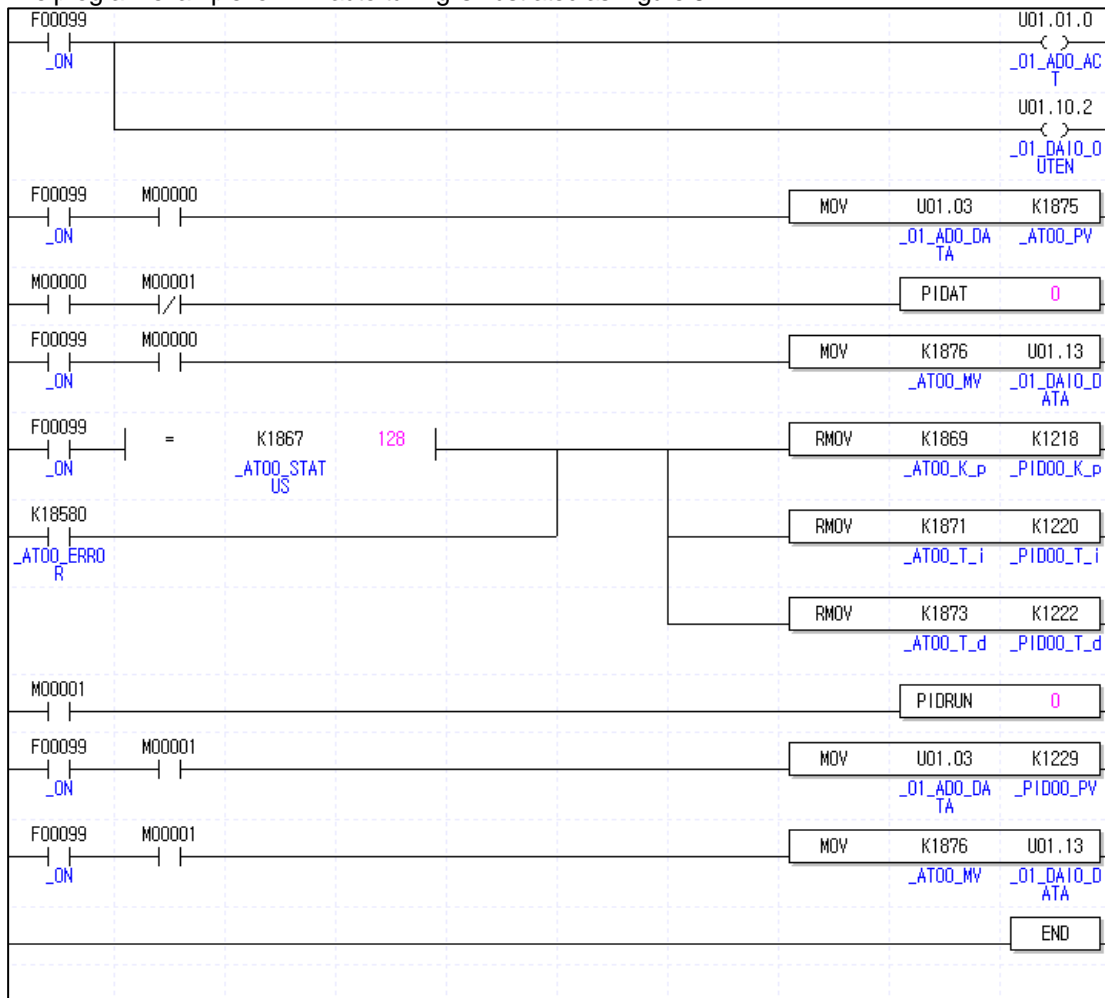

[Figure 6.27 Example program of PID control after auto-tuning]

1) Devices used

Device	Data type	Application
F0099	BIT	It is always on, so it readily operates once PLC is RUN.
U01.01.0	BIT	It starts operation of CH0 of Built-in A/D input module.
U01.10.2	BIT	It starts operation of CH0 of Built-in D/A output module.
U01.03	INT	PV entered to A/D input module.
U01.13	INT	MV entered to D/A output module.
K1875	INT	Device to which PV is entered for LOOP 0 auto-tuning
K1876	INT	Device to which auto-tuning MV of LOOP 0 is output.
K1867	WORD	Device to which auto-tuning status indicates.
K18580	BIT	Junction that is on once auto-tuning has an error.
K1869	REAL	proportional coefficient calculated after the auto-tuning
K1871	REAL	integral time calculated after the auto-tuning.
K1873	REAL	differential time calculated after the auto-tuning.

K1218	REAL	proportional coefficient of PID designated in parameter.
K1220	REAL	integral time of PID designated in parameter.
K1222	REAL	differential time of PID designated in parameter.
K1229	INT	Device to which PV is entered for Loop 0 PID control
K1876	INT	Device to which MV of loop 0 PID control is output.

## 2) Program explanation

- a) Since F0099 (always on) is ON if PLC is converted from STOP to RUN, CH0 of A/D and D/A starts operating.
- b) Once M0000 junction is on, the auto-tuning of loop 0 starts. At the moment, PV entered to CH0 of A/D is moved to K1875, the PV input device of loop 0 and saved accordingly.
- c) The auto-tuning MV of Loop 0 output by PIDAT command is output to D/A output module by line 11, MOV command.
- d) Once auto-tuning is complete, it moves P, I, D coefficients generated from auto-tuning to the input devices of P, I and D, K1218, K1220 and K1222, sets M001 and starts the operation of PID loop 0.

## 5.8 Error / Warning Codes

It describes error codes and warning codes of the XGB built-in PID function. The error codes and warning codes that may occur during use of the XGB built-in PID function are summarized as table. If any error or warning occurs, remove potential causes of the error by referring to the tables.

### 5.8.1 Error Codes

Error codes	Indications	Measures
H'0001	MV_MIN_MAX_ERR	It occurs when max. MV is set lower than min. MV. Make sure to set max. MV larger than min. MV.
H'0002	PV_MIN_MAX_ERR	It occurs when max. PV is set lower min. Pv. Make sure to set max. PV larger than min. PV.
H'0003	PWM_PERIOD_ERR	It occurs when the period of auto tuning or PID operation loop is set under 100(10ms). Make sure to set output period more than 100.
H'0004	SV_RANGE_ERR	It occurs when SV is larger than PV at the start time of auto-tuning if auto-tuning is forward or when SV is larger than PV at the start time of auto-tuning if auto-tuning is reverse.
H'0005	PWM_ADDRESS_ERR	It occurs when the junction designated as PWM output junction is beyond between P20 ~ P3F.
H'0006	P_GAIN_SET_ERR	It occurs when proportional constant is set lower than 0.
H'0007	I_TIME_SET_ERR	It occurs when integral time is set lower than 0.
H'0008	D_TIME_SET_ERR	It occurs when differential time is set lower than 0.
H'0009	CONTROL_MODE_ERR	It occurs when control mode is not P, PI, PD or PID.
H'000A	TUNE_DIR_CHG_ERR	It occurs when operation direction is changed during auto-tuning. Never attempt to change operation direction during auto-tuning.
H000B	PID_PERIOD_ERR	It occurs when period of operation is smaller than 100 (10ms) at Auto-tuning or PID operation. Make sure to set period of operation larger than 100.
H000C	HBD_WRONG_DIR	In mixed operation, It occurs when the direction parameter of forward operation set to reverse operation or the direction parameter of reverse operation set to forward operation. Make sure set to appropriate direction each loop.
H000D	HBD_SV_NOT_MATCH	In mixed operation, it occurs when the Set value of each loop is not concurrent. Make sure set to Set value concurrently.

[Table 6.13 : PID error codes]

## 5.8.2 Warning Codes

Error codes	Indications	Measures
H'0001	PV_MIN_MAX_ALM	It occurs when the set PV is beyond the min./max. PV.
H'0002	PID_SCANTIME_ALM	It occurs when PID operation cycle is too short. It is desirable to set PID operation cycle longer than PLC scan time.
H'0003	PID_dPV_WARN	It occurs when the PV change of PID cycle exceeds PV change limit.
H'0004	PID_dMV_WARN	It occurs when the PV cycle MV change exceeds MV change limit.
H'0005	PID_MV_MAX_WARN	It occurs when the calculated MV of PID cycle exceeds the max. MV.
H'0006	PID_MV_MIN_WARN	It occurs when the calculated MV of PID cycle is smaller than the min. MV

[Table 6.14 : PID error codes]

## Part 3. Positioning

### Chapter 1 Overview

XBM series transistor output type contains 2 positioning axes. This manual describes the specifications and usage of positioning.

#### 1.1 General

##### 1.1.1 Purpose of position function

The purpose of position function is to exactly move an object from the current position to a designated position and this function executes highly precise position control by sending a position pulse string signal to types of servo drive or stepping motor control drive. For applications, it may be widely used; for instance, machine tools, semiconductor assembling machine, grinder, small machine center, lifter and etc.

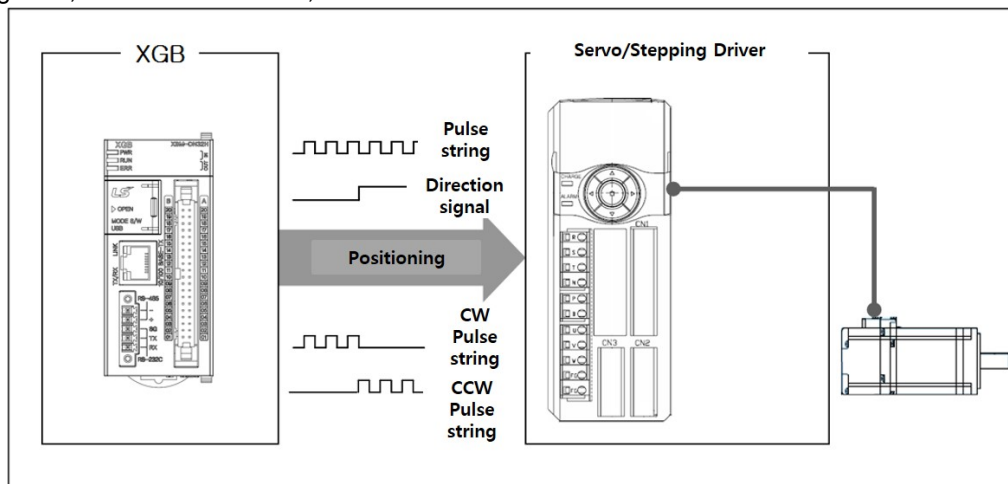

< XGB positioning function general >

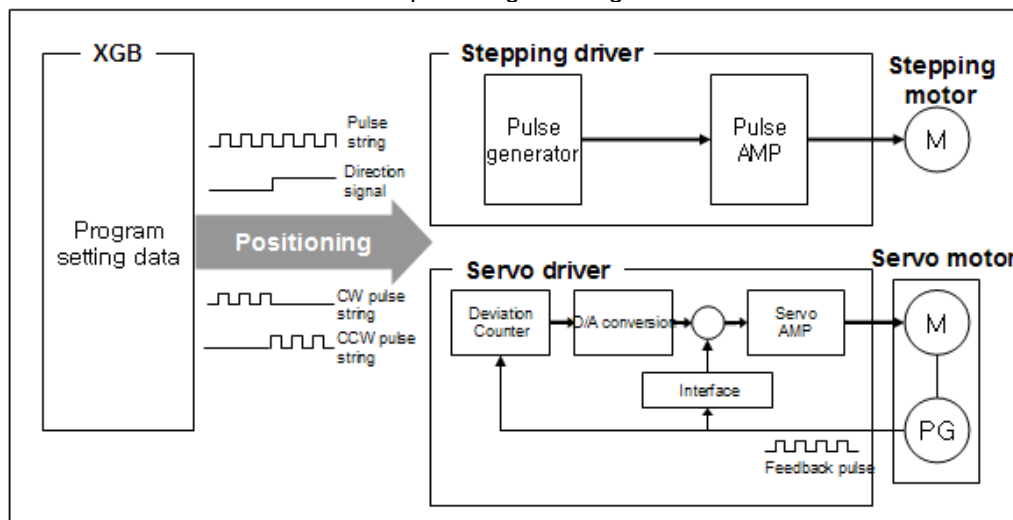

< Positioning system inner block diagram >



## 1.1.2 Features

Positioning function features the followings.

- (1) Max. two axis, 100kpps positioning
  - XGB PLC can execute positioning of up to 2 axes with up to 100kpps.
- (2) Diversity of positioning function
  - XGB PLC contains various functions necessary for position system such as position control at any temporary position or constant speed operation.
    - (a) Operation data containing position address, operation method and operation pattern may be set up to 80 steps per axis (based on "H" type). It executes position function by using this operation data.
    - (b) Linear control is available by using each operation data
      - The control can also perform single position control by one operation data and continuous position control by several operation data
      - (c) linear interpolation control is available.
    - (d) According to operation data and control types designated by parameters, position control, speed control, position/speed switching control and position/speed switching control are available
    - (e) It also provides various home return functions.
      - 1) Home return can be chosen among the following three.
        - Origin detection after DOG Off
        - When DOG On, Origin detection after deceleration
        - Origin detection by DOG
      - 2) temporary position can be set as machine's origin by using floating origin setting function.
- (3) Easy maintenance
  - It saves data such as position data and parameter into flash memory of main unit permanently.
  - The modified data during positioning can be preserved in the flash memory by application instruction (WRT/APM\_WRT instruction).
- (4) XG5000 can perform self-diagnosis, monitor and test.
  - (a) Diagnosing of I/O signal line.
  - (b) It can test all functions of built-in positioning or check the current operation status without program through special module monitoring
  - (c) It is easy to take action because the user can check error by error occurrence flag (Ch0: K4201, %KX6721 Ch1: K4301, %KX6881) and error code (Ch0: K427, %KW427 Ch1: K437, %KW437) easily.

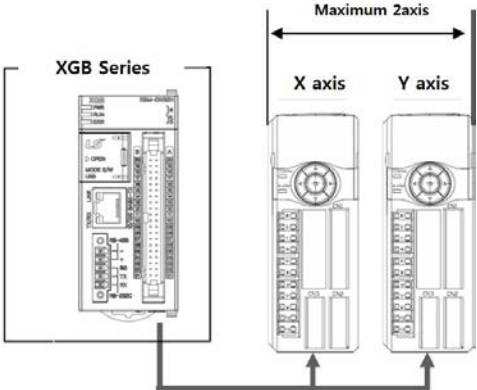
XGB positioning system	Reference
 <p>The diagram illustrates the XGB positioning system. On the left is the 'XGB Series' PLC unit. Two arrows point from the PLC to two separate motor units labeled 'X axis' and 'Y axis'. A horizontal double-headed arrow above these two motor units is labeled 'Maximum 2axis', indicating the system's capability to control up to two axes.</p>	<ul style="list-style-type: none"> <li>•For parameter setting, refer to Ch3.2 and for operation data setting, refer to Ch3.3.</li> <li>•For instruction of positioning, refer to Ch5.</li> <li>•For I/O signal, refer to Ch1.4.</li> </ul>

## 1.2 Performance specifications

### 1.2.1 Performance specifications of XGB built-in positioning

Item \ Type		XGB Basic Unit (Transistor output )	
		High-end type ("H" type)	
No. of control axis		2 axes	
Interpolation		2 axes linear interpolation	
Pulse output method		Open collector (DC 24V)	
Pulse output type		Pulse + Direction	
Control type		Position control, speed control, speed/position switching, position/speed switching	
Control unit		Pulse	
Position data		80 data areas per axis (operation step no. 1 ~ 80)	
		Setting	Setting through Embedded parameter of XG5000 → permanent auto-preservation
			Setting through dedicated monitoring package → permanent preservation by PADT instruction
			Setting through K area dedicated for positioning → permanent preservation by application instruction (WRT/APM_WRT instruction)
Positioning monitor		Special module monitoring of XG5000 / monitoring by K area	
Back-up		Parameter, operation data → MRAM K area → MRAM (Saving them in the flash memory is available by application instruction(WRT/APM_WRT))	
Position	Position method	Absolute method / Incremental method	
	Position address range	-2,147,483,648 ~ 2,147,483,647(Pulse)	
	Speed range	1 ~ 100,000pps(1pps unit)	
	Acc/dec processing	Trapezoid-shaped	
	Acc/dec time	1 ~ 10,000 ms (selectable from 4 types of acc/dec patterns)	
Max. output pulse		100 kpps	
Max. connection distance		2 m	

< Performance specifications >

## 1.3 Operation Sequence of Positioning

### 1.3.1 Operation Sequence of Positioning

Operation sequence is as follows.

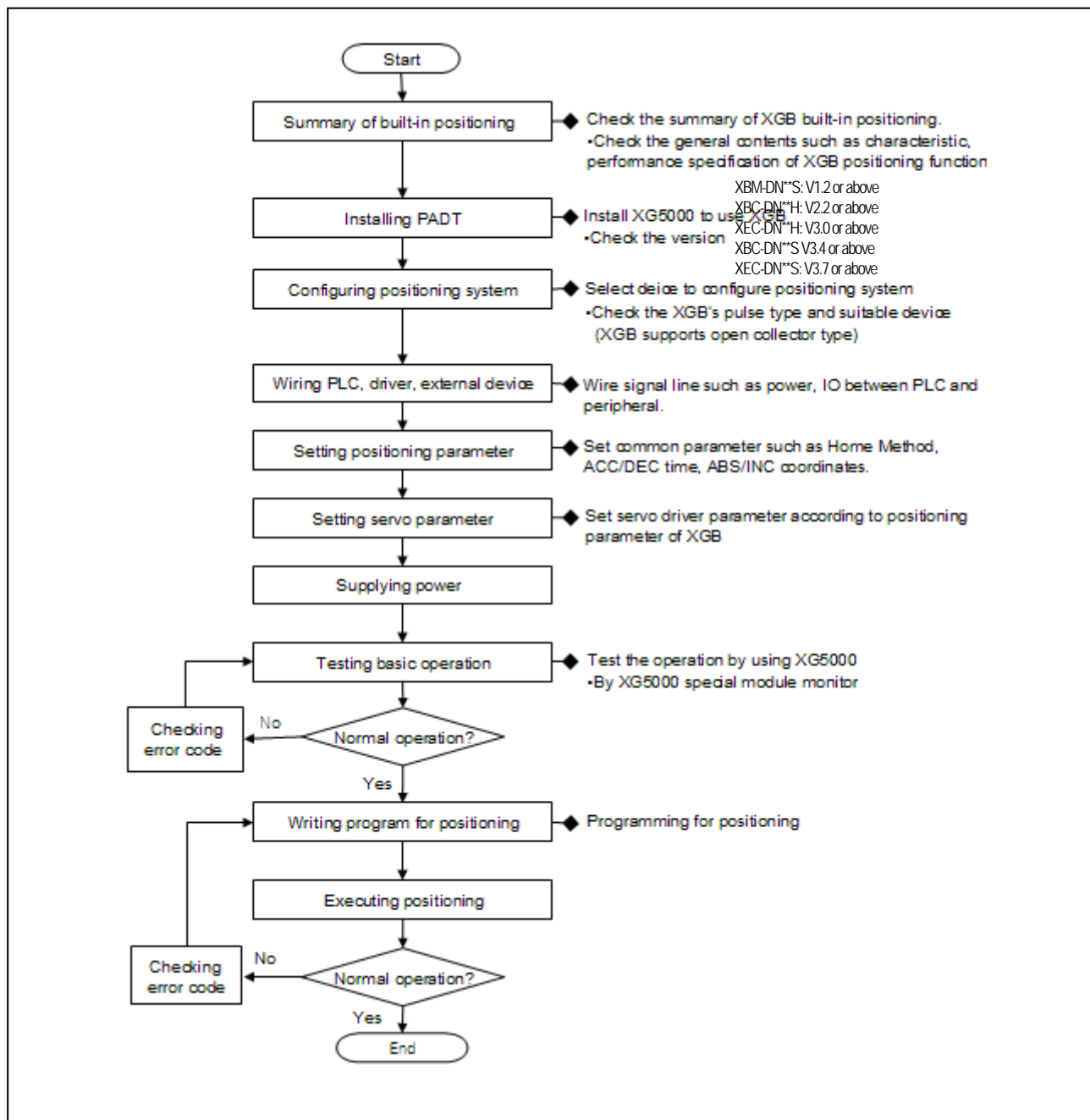

### 1.3.2 Flow of position signal

Flow of position signal is as follows.

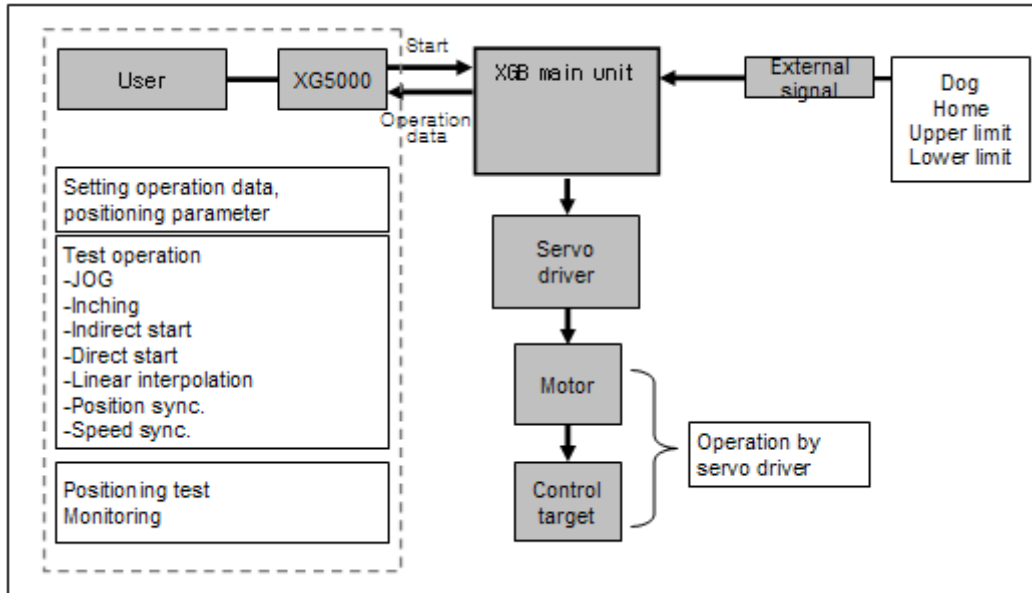

< XGB Positioning signal flow >

## 1.4 I/O Signal Allocation

### 1.4.1 Allocation of modular type input signal

In case of modular type, external I/O signal for built-in function is allocated as follows.

#### (1) Pin array of I/O connector

Pin array of I/O connector of XGB modular type transistor type basic unit is as follows.

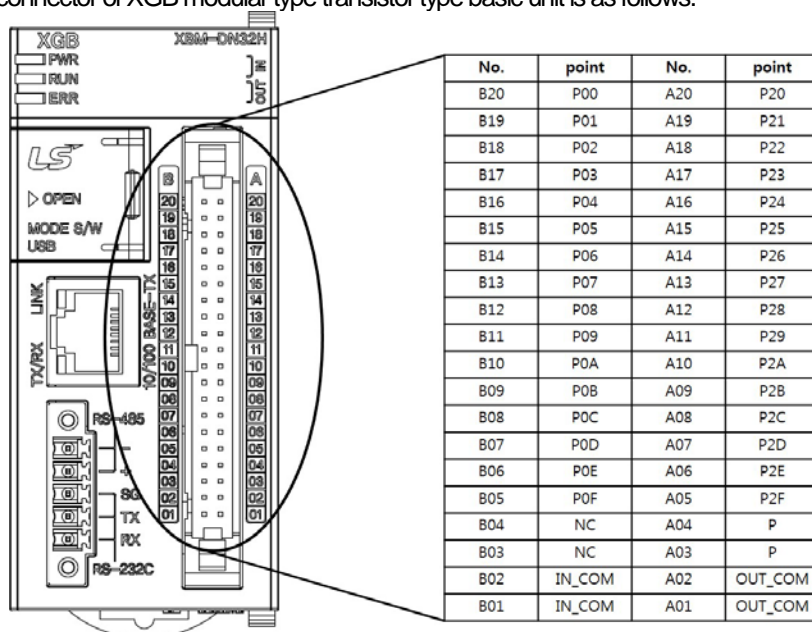

#### (2) Allocation of external input signal

Signal name	Input contact point no.		Detail	-
External lower limit signal (LimitL)	X axis	P0008	detected at the falling edge of input contact point.	Normally closed contact point (B contact point)
	Y axis	P000A	detected at the falling edge of input contact point.	
External upper limit signal (LimitH)	X axis	P0009	detected at the falling edge of input contact point.	
	Y axis	P0008	detected at the falling edge of input contact point.	
DOG signal	X axis	P000C	When homing, detected at the rising edge	Normally open contact point (A contact point)
	Y axis	P000E	When homing, detected at the rising edge	
ORIGIN signal	X axis	P000D	When homing, detected at the rising edge	
	Y axis	P000F	When homing, detected at the rising edge	
Input common	X/Y axis	COM	Input common	

- (3) Example of wiring the external input signal  
 Example of wiring the external input signal is as follows.

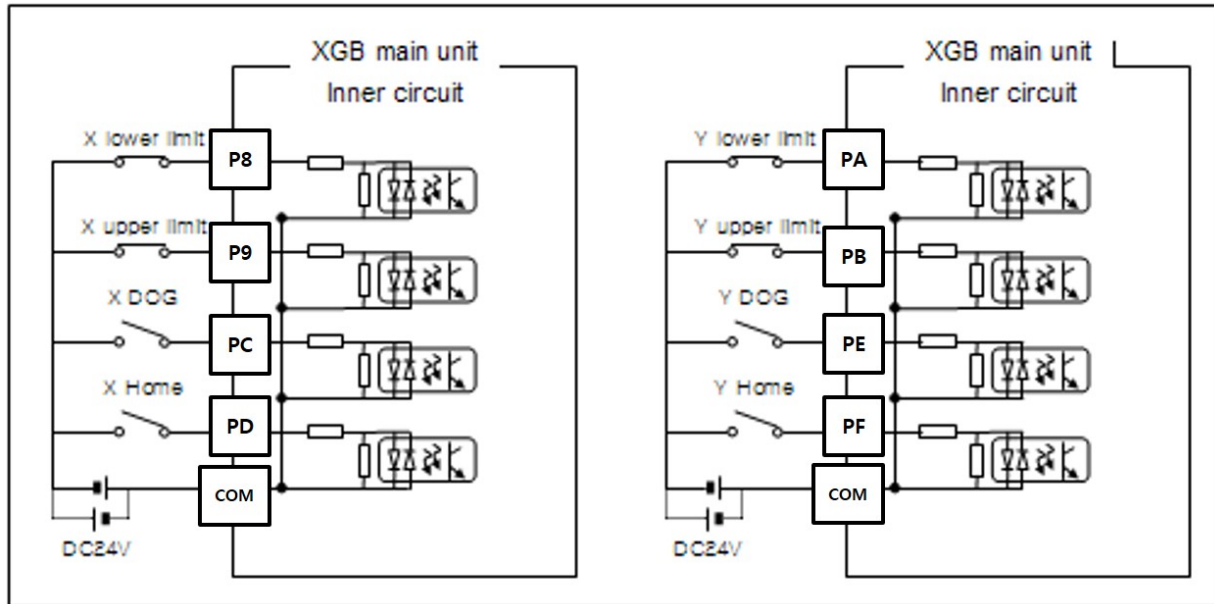

< Example of wiring the external input signal >

## 1.4.2 Allocation of modular type output signal

### (1) Allocation of output signal

When using the positioning function, the output signal is allocated as shown below.

Signal name	Input contact point no.		Detail	-
Pulse output	X axis	P0020	Positioning X axis pulse string output contact point (Open collector output)	Low Active and High Active is selectable in parameter setting.
	Y axis	P0021	Positioning Y axis pulse string output contact point (Open collector output)	
Direction output	X axis	P0022	Positioning X axis direction output contact point (Open collector output)	
	Y axis	P0023	Positioning Y axis direction output contact point (Open collector output)	
External 24V	X/Y axis	DC12 /24V	For external power (12/24V) supply	
Output common	X/Y axis	COM	Output common	

(2) Example of wiring external input signal

Example of wiring external output signal is as follows.

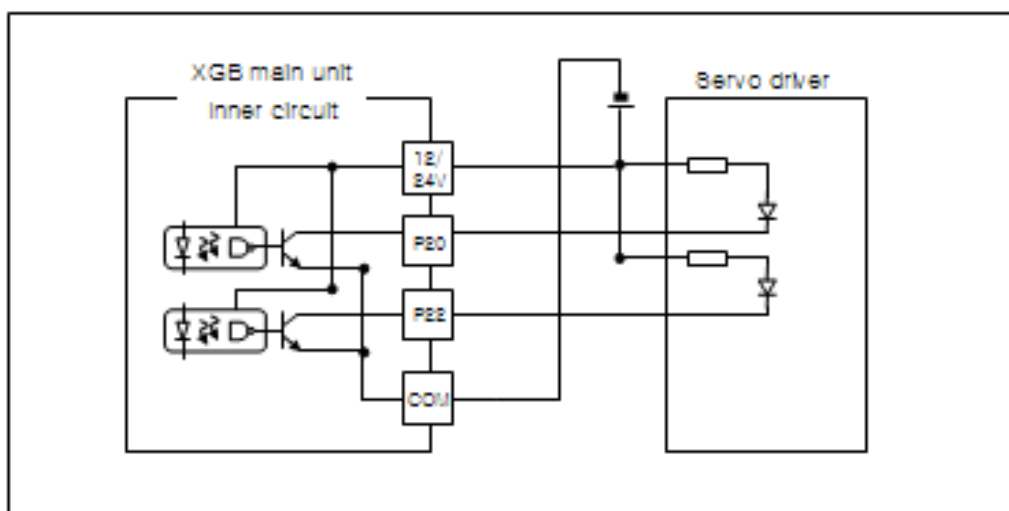

## Chapter 2 General Specifications

### 2.1 Input Specifications

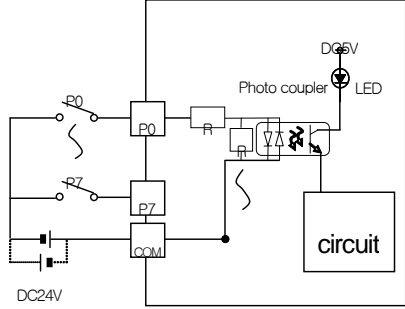
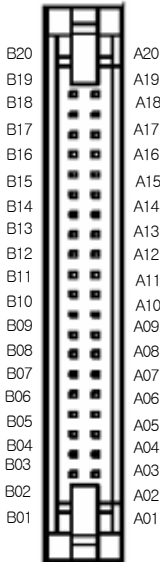
Contact point no.	X axis	P0008	P0009	P000C	P000D	Ref.			
	Y axis	P000A	P000B	P000E	P000F				
Signal name	External lower limit	External upper limit	DOG	HOME					
Rated input voltage	DC24V (DC20.4~28.8V (-15/20%, ripple rate 5% or less))								
Rated input current	About 4mA/24V								
Insulation method	Photo coupler insulation								
Input impedance	About 5.6kΩ								
On voltage/current	DC 19V or above /3.4mA or above								
Off voltage/current	DC 6V or less/1.1mA or less								
Response time	0.5ms or less (When used for positioning)								
Min. input width	200μs or above								
Circuit configuration and connector array					No.	point	Pin	point	
					B20	00	A20	20	
					B19	01	A19	21	
					B18	02	A18	22	
					B17	03	A17	23	
					B16	04	A16	24	
					B15	05	A15	25	
					B14	06	A14	26	
					B13	07	A13	27	
					B12	08	A12	28	
					B11	09	A11	29	
					B10	0A	A10	2A	
					B9	0B	A9	2B	
					B8	0C	A8	2C	
					B7	0D	A7	2D	
					B6	0E	A6	2E	
					B5	0F	A5	2F	
					B4	NC	A4	P	
					B3	NC	A3	P	
					B2	IN_COM	A2	OUT_COM	
B1	IN_COM	A1	OUT_COM						



## 2.2 Output Specifications

### 2.2.1 Output Specification



(1) Modular type output contact point specification

Contact no.	X axis	P0020	P0022		Ref.																																																																																					
	Y axis	P0021	P0023																																																																																							
Signal name	Pulse string output		Direction output																																																																																							
Rated load voltage	DC5~24V (DC4.75~26.4V)																																																																																									
Max. load current	0.1A/1 point or below																																																																																									
Insulation method	Photo-coupler insulation																																																																																									
Inrush current	1A/10ms or below																																																																																									
Voltage drop when On	DC 0.3V or below																																																																																									
Leakage current when Off	0.1mA or below																																																																																									
Response time	0.5us or below (10mA or above)																																																																																									
Circuit configuration and connector array (standard type)			<table border="1"> <thead> <tr> <th>No.</th> <th>Cont act</th> <th>No.</th> <th>Cont act</th> </tr> </thead> <tbody> <tr><td>B20</td><td>00</td><td>A20</td><td>20</td></tr> <tr><td>B19</td><td>01</td><td>A19</td><td>21</td></tr> <tr><td>B18</td><td>02</td><td>A18</td><td>22</td></tr> <tr><td>B17</td><td>03</td><td>A17</td><td>23</td></tr> <tr><td>B16</td><td>04</td><td>A16</td><td>24</td></tr> <tr><td>B15</td><td>05</td><td>A15</td><td>25</td></tr> <tr><td>B14</td><td>06</td><td>A14</td><td>26</td></tr> <tr><td>B13</td><td>07</td><td>A13</td><td>27</td></tr> <tr><td>B12</td><td>08</td><td>A12</td><td>28</td></tr> <tr><td>B11</td><td>09</td><td>A11</td><td>29</td></tr> <tr><td>B10</td><td>0A</td><td>A10</td><td>2A</td></tr> <tr><td>B9</td><td>0B</td><td>A9</td><td>2B</td></tr> <tr><td>B8</td><td>0C</td><td>A8</td><td>2C</td></tr> <tr><td>B7</td><td>0D</td><td>A7</td><td>2D</td></tr> <tr><td>B6</td><td>0E</td><td>A6</td><td>2E</td></tr> <tr><td>B5</td><td>0F</td><td>A5</td><td>2F</td></tr> <tr><td>B4</td><td>NC</td><td>A4</td><td>P</td></tr> <tr><td>B3</td><td>NC</td><td>A3</td><td>P</td></tr> <tr><td>B2</td><td>IN_COM</td><td>A2</td><td>OUT_COM</td></tr> <tr><td>B1</td><td>IN_COM</td><td>A1</td><td>OUT_COM</td></tr> </tbody> </table>		No.	Cont act	No.	Cont act	B20	00	A20	20	B19	01	A19	21	B18	02	A18	22	B17	03	A17	23	B16	04	A16	24	B15	05	A15	25	B14	06	A14	26	B13	07	A13	27	B12	08	A12	28	B11	09	A11	29	B10	0A	A10	2A	B9	0B	A9	2B	B8	0C	A8	2C	B7	0D	A7	2D	B6	0E	A6	2E	B5	0F	A5	2F	B4	NC	A4	P	B3	NC	A3	P	B2	IN_COM	A2	OUT_COM	B1	IN_COM	A1	OUT_COM		
			No.	Cont act	No.	Cont act																																																																																				
			B20	00	A20	20																																																																																				
			B19	01	A19	21																																																																																				
			B18	02	A18	22																																																																																				
			B17	03	A17	23																																																																																				
			B16	04	A16	24																																																																																				
			B15	05	A15	25																																																																																				
			B14	06	A14	26																																																																																				
			B13	07	A13	27																																																																																				
			B12	08	A12	28																																																																																				
			B11	09	A11	29																																																																																				
			B10	0A	A10	2A																																																																																				
			B9	0B	A9	2B																																																																																				
			B8	0C	A8	2C																																																																																				
			B7	0D	A7	2D																																																																																				
			B6	0E	A6	2E																																																																																				
			B5	0F	A5	2F																																																																																				
			B4	NC	A4	P																																																																																				
			B3	NC	A3	P																																																																																				
B2	IN_COM	A2	OUT_COM																																																																																							
B1	IN_COM	A1	OUT_COM																																																																																							

## 2.2.2 Output Pulse level

Output pulse of XGB built-in positioning consists of Pulse + Direction like figure below.

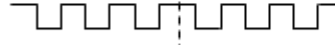
At this time, output level of Low Active and High Active can be specified by positioning parameter and K area flag dedicated for positioning (X axis: K4871, Y axis: K5271 ).

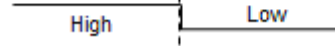
Pulse output type	Output signal	Output signal level				Reference
		High Active mode		Low Active mode		
		Forward	Reverse	Forward	Reverse	
Pulse + direction mode	Pulse					Supported at S, H type
	Direction					



## Chapter 3 Before Positioning

It describes the function of position control, operation parameter setting, operation data setting, K area for positioning, servo driver setting and programming.

### 3.1 Positioning Function

#### 3.1.1 Positioning function list

Positioning function of XGB built-in positioning is as follows. For more detail, refer to ch.5.2.

Positioning function	Operation description		Instruction	Ref.
Position control	Operation pattern		DST IST APM_DST APM_IST	Ch.5.2.3 Ch.5.2.4 Ch.5.3.4 Ch.5.3.5
	Operation	If the rising edge of start command is detected, it moves with designated speed to designated position and after dwell time, complete signal is on during one scan.		
Speed control	Operation pattern		DST IST APM_DST APM_IST	Ch.5.2.3 Ch.5.2.4 Ch.5.3.4 Ch.5.3.5
	Operation	If the rising edge of start command is detected, it moves with designated speed and stops after deceleration by stop command. At this time, complete signal will not be on.		
speed/position switching control	Operation pattern		VTP APM_VTP	Ch.5.2.7 Ch.5.3.8
	Operation	Speed control is executed by start command and it is switched to position control by switching signal and it moves to designated position.		

Positioning function	Operation description		Instruction	Ref.
Position/speed switching control	Operation pattern		PTV APM_PTV	Ch.5.2.8 Ch.5.3.9
	Operation	Position control is executed by start command and it is switched to speed control by switching signal and stops after deceleration by stop command .		
Linear interpolation control	Operation pattern		LIN APM_LIN	Ch.5.2.5 Ch.5.3.6
	Operation	2 axes linear interpolation control is executed by start command from current position to target position.		
Simultaneous start	Operation pattern		SST APM_SST	Ch.5.2.6 Ch.5.3.7
	Operation	X axis and Y axis starts simultaneously by start command. At this time, each operation data such as operation speed, target position is applied to each axis.		
Sync start	Operation pattern		SSP SSS APM_SSP APM_SSSB	Ch.5.2.10 Ch.5.2.11 Ch.5.3.11 Ch.5.3.12
	Operation	If sync start is executed by command, subsidiary axis is synchronized with main axis' position or speed. At this time, setting of subsidiary axis is ignored and operates according to the operating status of main axis		

Positioning function	Operation description		Instruction	Ref.
Home return	Operation pattern	<p>&lt;Home example by DOG&gt;</p>	ORG APM_ ORG	Ch.5.2.1 Ch.5.3.2
	Operation	It goes to home direction and detects the mechanical origin At this time, home method can be specified by operation parameter.		
Position override	Operation pattern		POR APM_P OR	Ch.5.2.12 Ch.5.3.13
	Operation	It changes the target position by position override command.		
Speed override	Operation pattern		SOR APM_ SOR	Ch.5.2.13 CH.5.3.14
	Operation	It changes the speed by speed override command.		
Speed override with position	Operation pattern		PSO APM_ PSO	Ch.5.2.14 Ch.5.3.15
	Operation	It changes the speed at the designated position by speed override with position command.		

### 3.1.2 Position control

Position control is to move the designated axis from start address (present position) up to target address (movement). There are two position control methods, absolute and incremental.

#### (1) Control by absolute coordinates (Absolute coordinates)

**Object moves from start address to target address. Position control is performed, based on the address designated in Home Return (home address).**

**Direction is determined by start address and target address.**

- Start address < target address: forward positioning
- Start address > target address: reverse positioning

#### (a) example

- It assumes that operation data is specified as shown table 3-1. (For how to set operation parameter, refer to the Ch.3.3)

Step no.	Coord.	Pattern	Control	Method	Rep step	Address [Pulse]	M Code	A/D No.	Speed [pls/s]	Dwell [ms]
1	ABS	END	POS	SIN	0	8,000	0	1	100	10

<Table 3-1 operation data example of absolute coordinates type>

- In table 3-1, since coordinates is 'ABS', control method is 'POS', step no. 1 is position control by absolute coordinates.
- It assumes that the current position is 1000. Since address in step no.1 is 8000, object moves to 8000 as shown figure and increment is  $8000-1000=7000$ . Object moves forward because target address is larger than start address.

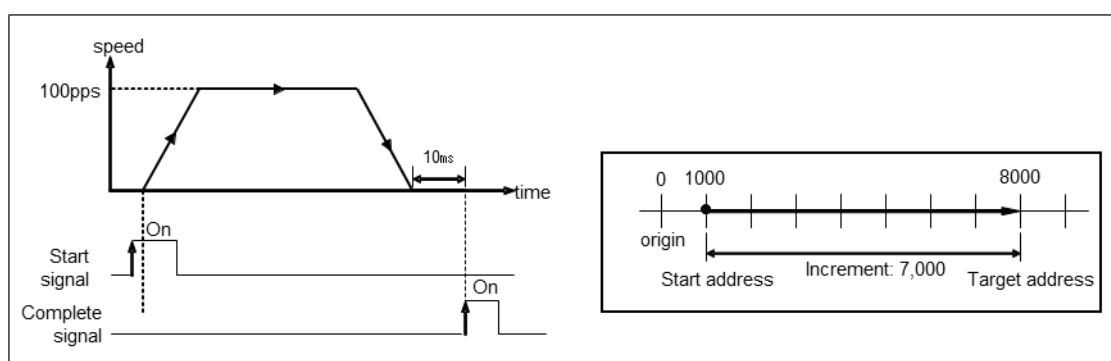

<Figure 3-1 operation example of absolute coordinates type>

#### Remark

- Every position/speed control is available as long as the origin is determined preliminarily.
- If it is executed while origin is not determined, error code 234 occurs and it doesn't move.
  - In case error occurs, refer to App.1.2 and remove the cause of error.
- Complete signal is on during one scan.

## (2) Control by incremental coordinates

**Object moves from current position as far as the address set in operation data. At this time, target address is based on start address. Direction is determined by sign (+,-).**

- In case Address is positive number: forward positioning (Direction increasing address)
- In case Address is negative number: reverse positioning (Direction decreasing address)

## (a) Example

- It assumes that operation data is specified as shown table 3-2. (For how to set operation parameter, refer to the Ch.3.3)

Step no.	Coord.	Pattern	Control	Method	Rep step	Address [Pulse]	M Code	A/D No.	Speed [pls/s]	Dwell [ms]
1	<b>INC</b>	END	<b>POS</b>	SIN	0	-7,000	0	1	100	10

<Table 3-2 operation data example of incremental coordinates type>

- In table 3-1, since coordinates is 'INC', control method is 'POS', step no. 1 is position control by incremental coordinates.
- It assumes that current position is 5000. Since object moves as long as -7000, target stop at -2000 (absolute coordinates) as shown figure 3-2. At this time, increment is -7000 pulse and direction is reverse.

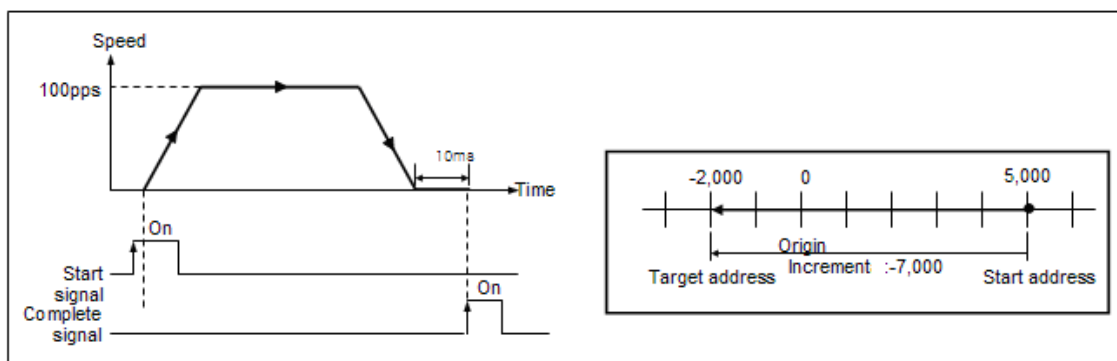

< Figure 3-2 operation example of incremental coordinates type>

### 3.1.3 Speed control

- Speed control means that object moves with steady speed (steady pulse string) until stop command.
- In case of speed control, direction is determined by sign of Address set in operation data.
  - Forward : Address is positive number
  - Reverse : Address is negative number
 In the speed control, direction is determined by sign of target address regardless of current position and target position.
  - For example, current position is 100 and target position is 90, though target position is less than current position, since sign is positive, it moves forward.



- In case of speed control, some items as figure below doesn't affect the operation.

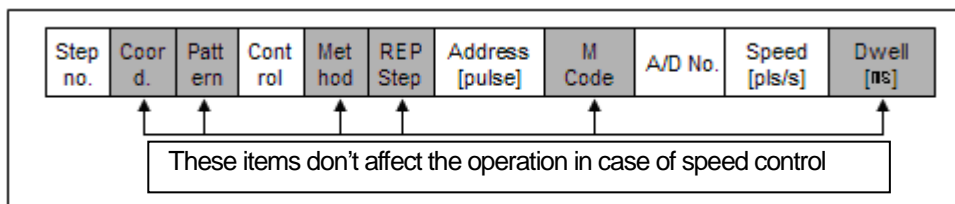

- If Control is specified as SPD, coordinates, pattern, method, M code, dwell time doesn't affect the operation.
- So in case of speed control, when object stops by STP command, it stops without dwell time and M code doesn't operate.

### (1) Example

- It assumes that operation data is specified as shown table 3-3

Step no.	Coord.	Pattern	Control	Method	Rep step	Address [Pulse]	M Code	A/D No.	Speed [pls/s]	Dwell [ms]
1	INC	END	<b>SPD</b>	SIN	0	10	10	1	100	10

<Table 3-3 operation data example of speed control>

- In table 3-3, since Control is 'SPD', step no. 1 is operation data of speed control.
- Since Address is positive number and Speed is 100, target moves forward with 100 pls/s speed regardless of current position until stop command (DEC. stop or EMG stop).
- If object moves, flag (X axis: K4200, %KX6720, Y axis: K4300, %KX6880) is on. And if DEC. stop command is executed, it stops after deceleration without dwell time and flag turns off immediately.
- At this time, deceleration time conforms to that in operation data, not operand of instruction.

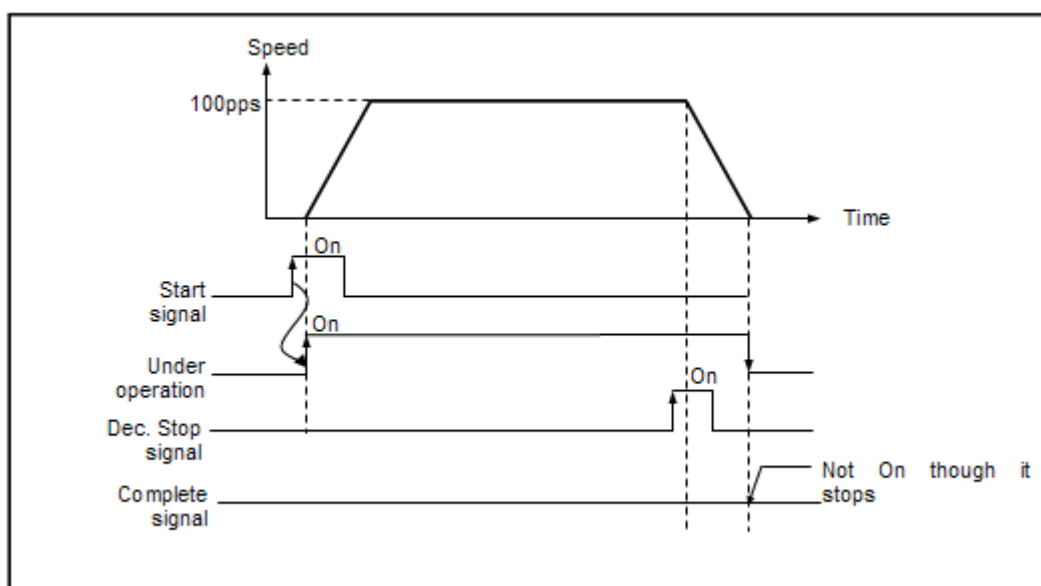

< Figure 3-3 Operation of speed control >

### 3.1.4 Speed/position switching control

- It change speed control to position control by switching command (VTP instruction).
- In case of speed/position switching control, items affecting the operation are different according to control method.

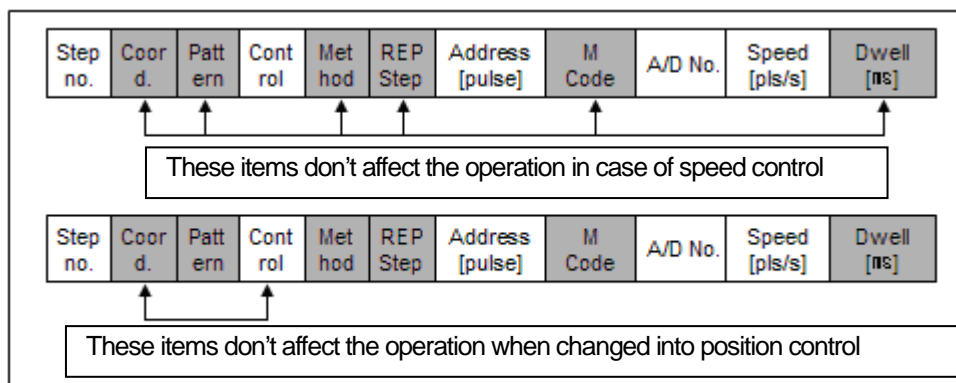

- First, object moves by speed control. If speed/position switching control is executed, target will move by position control.
- At this time, position control is executed by absolute coordinates with initializing the current position as 0. So coordinates item doesn't affect the operation.
- Since control method also changes by speed/position switching, control method in the operation data doesn't affect the operation.
- In case of speed/position switching, object keeps its previous direction.

#### (1) Example

- It assumes that operation data is specified as shown table 3-4.

Step no.	Coord.	Pattern	Control	Method	Rep step	Address [Pulse]	M Code	A/D No.	Speed [pls/s]	Dwell [ms]
1	INC	END	SPD	SIN	0	1000	11	1	500	100

<Table 3-4 operation data example of speed/position switching control>

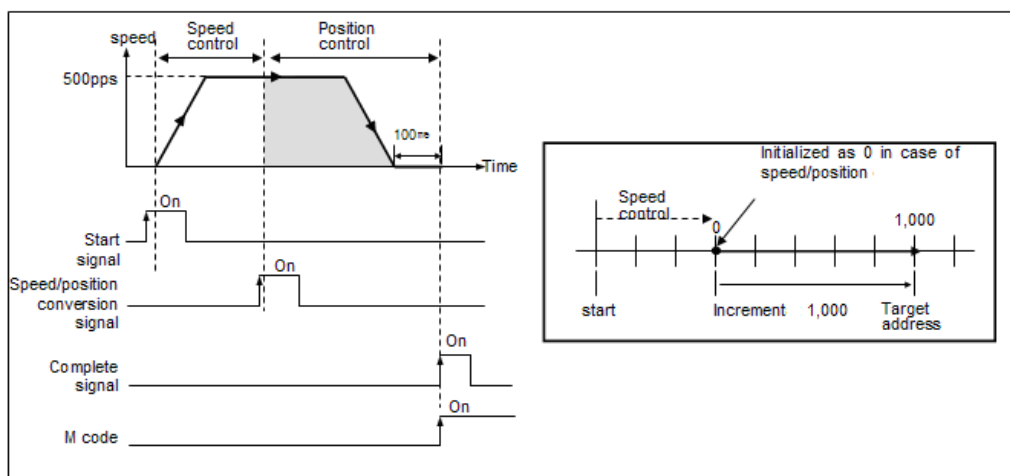

< Figure 3-4 Operation of speed/position switching control >

- If step no. 1 in table 3-4 starts, object moves forward by speed control because Control is SPD and Address is positive number.
- If speed/position switching command (VTP instruction) is executed during speed control, current position will be initialized as 0 and object moves by position control until 1000.
- If object reaches target position, complete flag and M code occurrence flag will be on after dwell time. At this time, M code number 11 is displayed as set in operation data.
- Positioning complete flag will be on during one scan and M code occurrence flag keeps on status, until it is turned off by off command.

**Remark**

- M code occurrence flag is turned off by MOF instruction.
- Using MOF instruction, M code occurrence flag and M code number will be clear simultaneously.
- Speed/position switching command is executed only when each axis is operating.  
If it is executed during stop, it may cause error.
- If position/speed switching command is executed during operation by speed control, the command is ignored. But at this time, error is not occurred.

**3.1.5 Position/speed switching control**

- It change position control to speed control by switching command (VTP instruction).
- In case of position/speed switching control, items affecting the operation are different according to control method. In case position control, all items affect the operation but in case of speed, some items affect the operation as shown below.

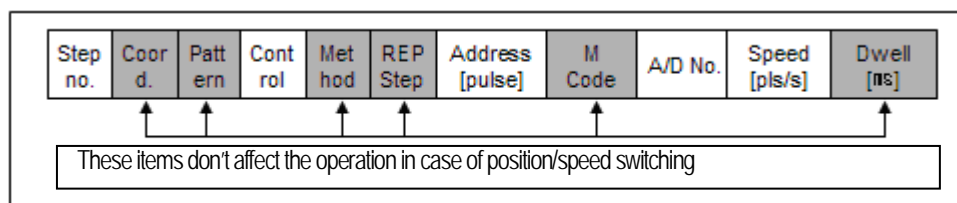

- First, object moves by position control. If position/speed switching control is executed, object will move by speed control. At this time, the current position is not initialized. Only control method changes into speed control and it continues operation
- When control method changes, some items in operation data doesn't affect the operation.

**(1) Example**

- It assumes that operation data is specified as shown table 3-5.

Step no.	Coord.	Pattern	Control	Method	Rep step	Address [Pulse]	M Code	A/D No.	Speed [pls/s]	Dwell [ms]
1	INC	END	POS	SIN	0	10000	12	1	500	100

< Table 3-5 operation data example of position/speed switching control >

- If step no. 1 in table 3-5 starts, object moves by position control according to operation data in table 3-5 because Control is POS.

- If position/speed switching command (VTP instruction) is executed during position control, object moves by speed control until stop command.
- If object stops by stop command, it will stop without dwell time and positioning complete flag will not be on.

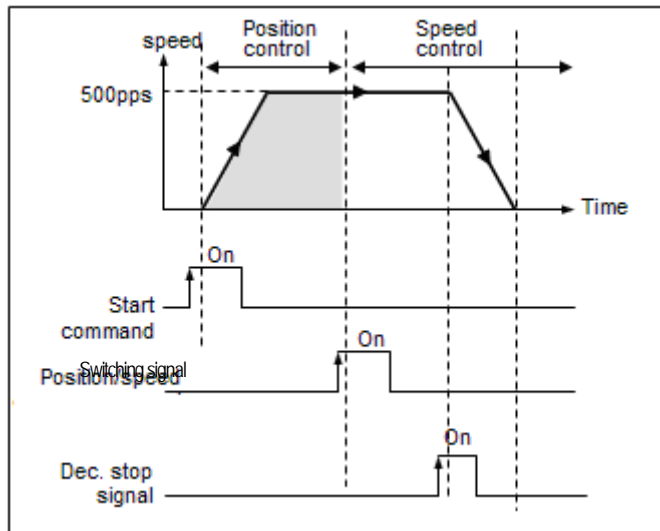

<Figure 3-5 Operation of position/speed switching control>

#### Remark

- Position/speed switching command is executed only when each axis is operating. If it is executed during stop, it may cause error.
- If speed/position switching command is executed during operation by position control, the command is ignored and causes error. But at this time, positioning doesn't stop.

### 3.1.6 Linear interpolation control

- Object moves by linear interpolation control from start address to target address using two axes, X, Y. There are two methods in linear interpolation control, absolute coordinates and incremental coordinates.

#### (1) Control by absolute coordinates

**When linear interpolation control is executed, object moves based on the origin designated by Home return.**

**Direction is determined by start address and target address for each axis.**

- start address < target address: Forward
- start address > target address: Reverse

## (a) How to set operation data

**In the linear interpolation control, since two axes operates simultaneously, it needs attention. The following is notice when setting the operation data.**

## 1) Determining main axis

- For linear interpolation, first you have to determine the main axis. In the XGB built-in positioning, main axis is determined automatically. The one which has a large moving amount becomes main axis.

## 2) Determining control method

- In the linear interpolation operation, control methods of both axes should be specified as "position". If not, error will occur and it will not be executed.

## 3) Setting of operation pattern

- In case of main axis, operation pattern should be specified as 'END' or 'KEEP'. In case it is specified as 'CONT', it operates as 'KEEP'.
- In case of subsidiary, pattern doesn't affect the operation, it operates according to main axis pattern.

## (b) Example

- It assumes that operation data is specified as shown table 3-6 and current position are X=1000, Y=4000.

Step no.	Coord.	Pattern	Control	Method	Rep step	Address [Pulse]	M Code	A/D No.	Speed [pls/s]	Dwell [ms]	Step no.
X	1	ABS	END	POS	SIN	0	8000	0	0	500	100
Y	1	ABS	KEEP	POS	REP	3	1000	0	0	2000	20

<Table 3-6 operation data example of linear interpolation control by absolute coordinates>

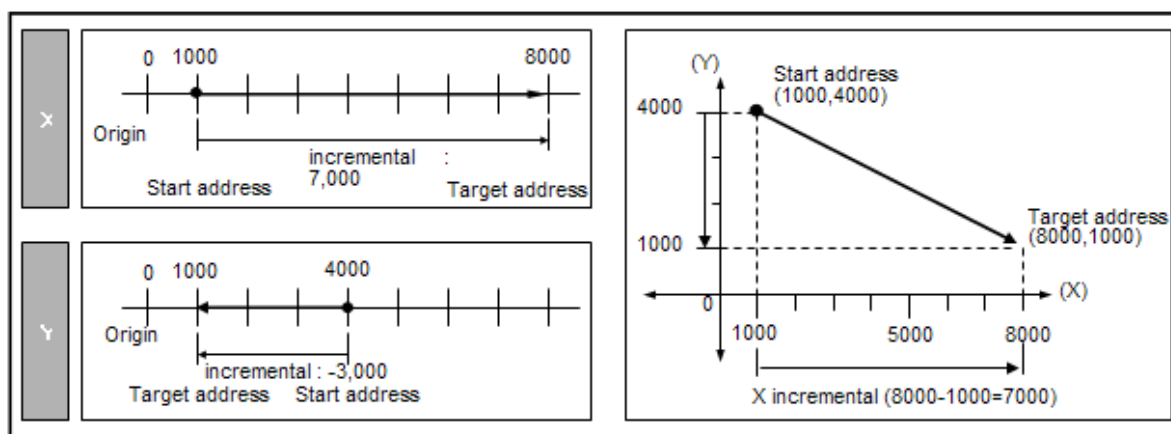

< Figure 3-6 linear interpolation operation by absolute coordinates >

- If linear interpolation starts, main axis is determined automatically based on moving amount of X and Y axis. In table 3-6, since moving amount of X axis is larger than Y axis X, X axis becomes main axis.
- So operation pattern, speed, A/D number, dwell time of Y axis is ignored and it is specified automatically according to operation data of X axis.
- Figure 3-7 indicates operation of linear interpolation control.

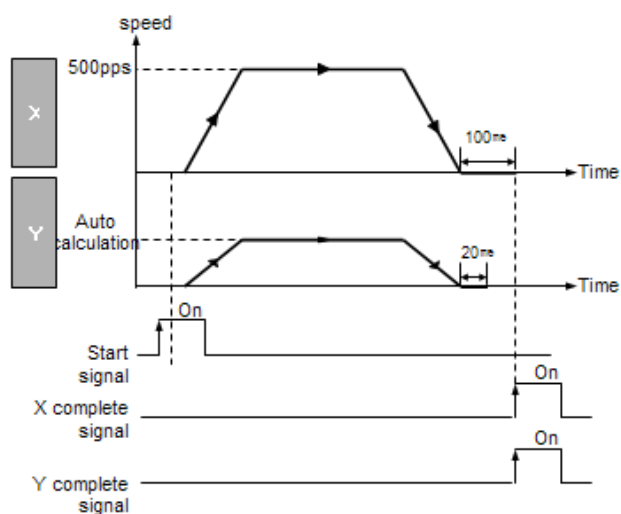

< Figure 3-7 operation of linear interpolation control >

## (2) Control by incremental coordinates

It executes the linear interpolation control based on current position by incremental coordinates. At this time, Address of operation data means how long object moves from current position. Direction is determined sign of Address.

- In case Address is positive number: forward
- In case Address is negative number: backward

### (a) Example

- It assumes that operation data is specified as shown table 3-7 and current position are  $X=1000$ ,  $Y=4000$ .

Step no.	Coord.	Pattern	Control	Method	Rep step	Address [Pulse]	M Code	A/D No.	Speed [pls/s]	Dwell [ms]	Step no.
X	1	INC	END	POS	SIN	0	6000	0	0	500	100
Y	1	INC	KEEP	POS	REP	3	-2000	0	0	2000	20

< Table 3-7 operation data example of linear interpolation control by absolute coordinates >

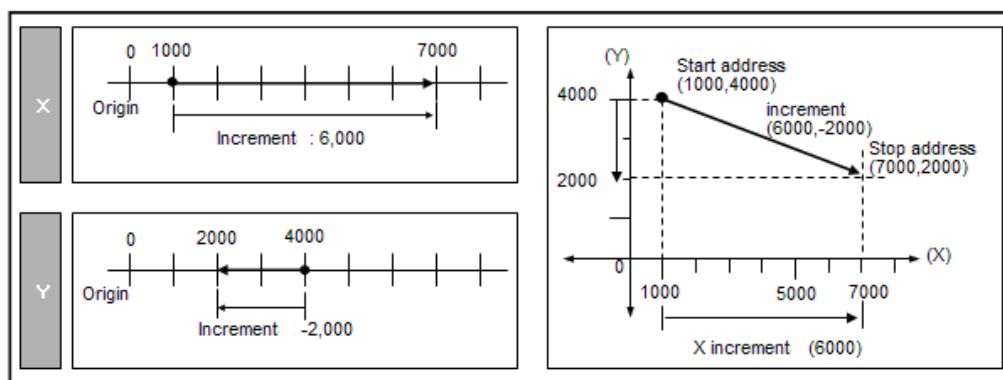

< Figure 3-8 linear interpolation operation by absolute coordinates >

- If linear interpolation is executed, main axis is determined according to moving amount of X and Y axis. In table 3-7, since moving amount of X axis is larger than Y, X axis becomes main axis.
- So subsidiary Y axis operation pattern, operation speed, ACC/DEC time, dwell time do not affect the operation and recalculated according to operation data of main axis. For example, if you execute the linear interpolation control with operation data such as table 3-7, subsidiary Y axis starts as END, SINGLE operation and operates with automatically calculated ACC/DEC speed and operation speed, as for Dwell time after stop, 100ms, dwell time of main axis X is applied. not 20ms, setting value.

#### Remark

- A special attention should be paid that linear interpolation start operates on 2 axes simultaneously.
- Pattern of main axis can specified as 'END', 'KEEP'. If it is specified as 'CONT', object moves as it is 'KEEP'.
- Available commands during linear interpolation are DEC. STOP, EMG. STOP.
- During linear interpolation operation, position/speed switching control, speed override, position override, speed override with position, If those are executed during liner interpolation operation, it may cause error.
- Operation method, operation pattern, speed limit, dwell time is specified as that of main axis.
- Speed, acceleration/deceleration time, bias speed of subsidiary axis is calculated again automatically.
- Backlash compensation amount, SW upper/lower limit is specified as it is for each axis.

### 3.1.7 Simultaneous start control

- It starts each step for each axis simultaneously by simultaneous start control (SST instruction).
- If SST instruction is used, it can remove delay of start caused by scan time delay.

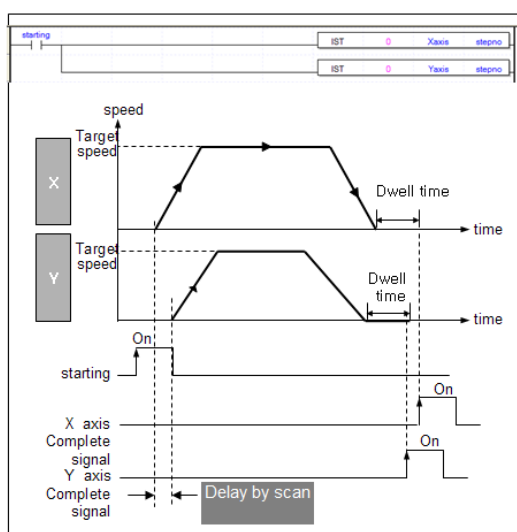

In case of starting each axis in the scan program

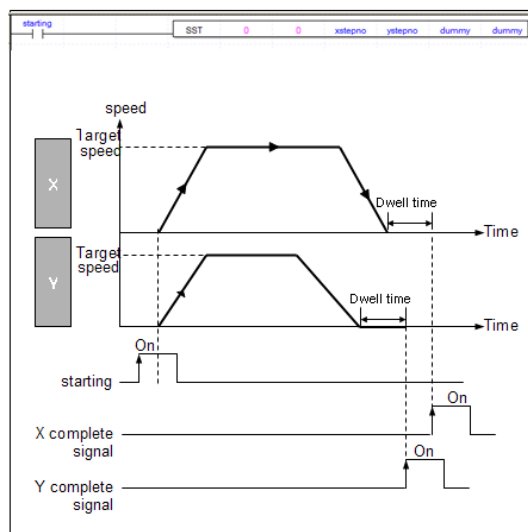

In case of using SST command

- SST instruction can be executed when two axes stop. If SST instruction is executed again after stop, in case of incremental coordinates, the current position is initialized as 0.

### 3.1.8 Sync control

• In sync control, position or speed of subsidiary axis is synchronized with that of main axis. There are two types in sync control, speed sync control and position sync control.

#### (1) Position sync control

- Position sync control means starting the operation step of subsidiary at the time when position of main axis is same with position set in SSP instruction (Sync control)

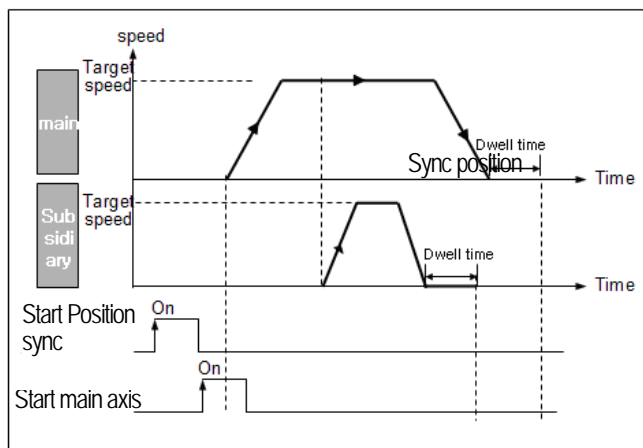

- Position sync control can be executed when origin of both axes is determined. When executing the SSP instruction, if origin of main axis is not determined, error code 346 occurs and for subsidiary axis, error code 344.
- When using SST instruction, specify the main axis to be different with subsidiary axis. If not, error code 347 will occur.
- If synch control is executed, though pulse is not yielded until main axis goes to designated axis, flag indicating whether subsidiary axis moves or not, turns on (X axis: K4200, %KX6720, Y axis: K4300, %KX6880).
- After executing position sync control, if the user wants to cancel the execution of position sync control, execute the STP instruction (stop command).

#### (2) Speed sync control

- If main axis starts as figure below, subsidiary axis moves with speed of sync speed rate set in the SSS instruction (speed sync command).

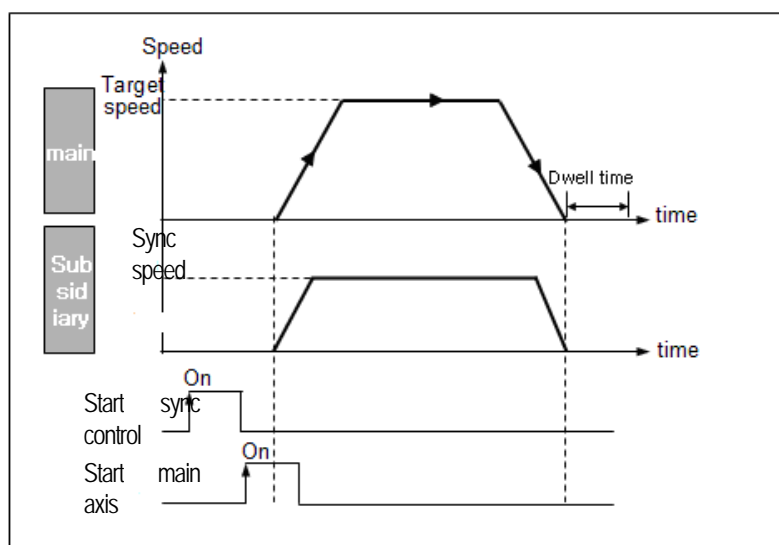



- It can be executed when origin of subsidiary axis is not determined.
- Since subsidiary axis moves according to speed of main axis, whether main axis moves by speed control or position control doesn't matter. At this time, direction of subsidiary axis is same as that of main axis.
- When sync control is executed and main axis stops, though pulse is not outputted, flag indicating whether subsidiary axis moves or not, turns on (X axis: K4200, %KX6720, Y axis: K4300, %KX6880).
- In case of speed synch control, sync speed rate is 0.00% ~ 100.00%. If it is out of range, error code 356 occurs.
- After executing speed sync control, if the user wants to cancel the execution of speed sync control, execute the STP instruction (stop command).
- When executing speed sync control, if M code is on, error code 353 will occur.
- The user can set X axis, Y axis, channel 0~3 of High speed counter as main axis in the speed sync control. For more detail, refer to Ch.5.2.12.

### 3.1.9 Home return

• Home return is used to find mechanical origin when starting machine. Home return is executed according to home parameter for each axis. In home parameter, items affecting homing are as follows. (For setting of each parameter, refer to Ch.3.2)

Type	Items	Description	-
Home parameter	Home Method	Setting home method	
	Home Direction	Start direction when homing	
	Home Address	Origin address when detecting origin	
	Home High/Low speed	High/Low speed when homing	
	Homing ACC/DEC Time	ACC/DEC time when homing	
	DWELL time	Time required to remove offset pulse of remaining bias counter immediately after positioning ends	

- When origin is determined by homing, though the user inputs homing signal and DOG signal, those are ignored.

#### (1) Type of Home method

Generally, home method can be divided into one using DOG and another not using DOG. In the XGB built-in positioning, there are three methods using DOG.

Home method	Necessary input signal	Reference
Origin detection after DOG off (0: DOG/HOME(OFF))	DOG, Origin	Content of ( ) is displayed in the Home Parameter of XG5000.
Origin detection after DEC. when DOG on (1: DOG/HOME(On))	DOG, Origin	
Origin detection by DOG (2: DOG)	DOG	

## (2) Origin detection after DOG Off

The operations by Home Return instruction using DOG and origin signal are as follows.

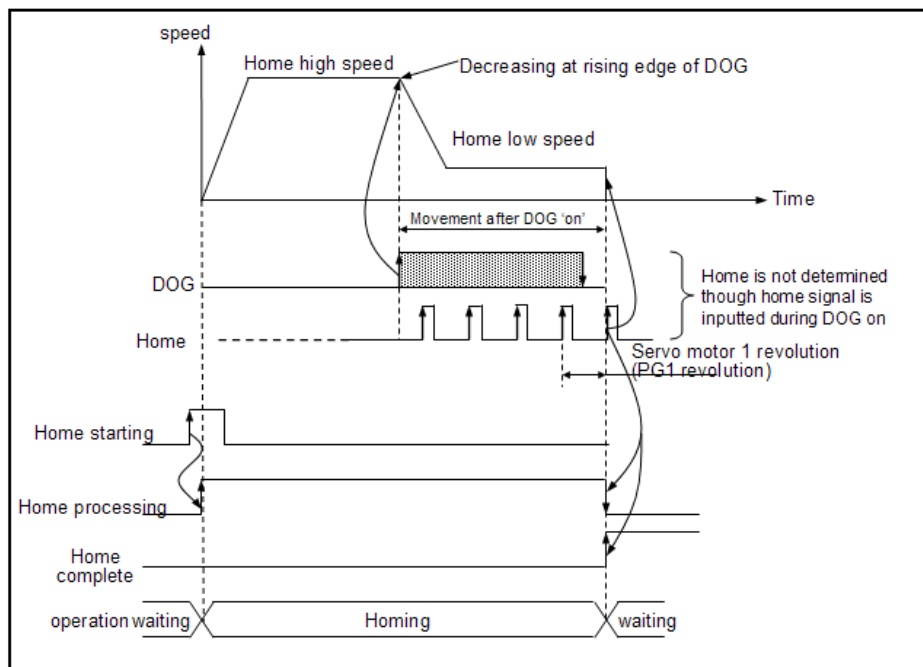

- If home return command (ORG instruction) is executed, it accelerates toward a preset home return direction and with Home high speed.
- During operating with Home Return High speed, if rising edge of DOG signal occurs, it operates with Home Return Low speed and monitors if there is falling edge of DOG signal. At this time, though Origin signal is inputted while DOG signal is On, Origin is not determined.
- If first origin signal is entered after DOG signal changes from "On" to "Off", it stops.

## Remark

- While DOG signal is "On", origin is not determined by origin signal. That is, origin may be determined as soon as origin signal is inputted after DOG signal changes from "On" to "Off".

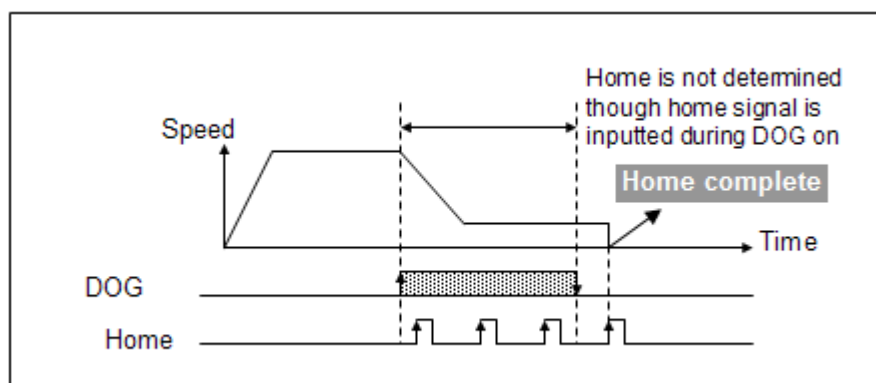

## Remark

- In speed-decreasing section, origin is not determined. Though DOG changed from "On" to "Off" and Origin signal is inputted in speed-decreasing section, origin is not determined. Origin is determined at first Origin signal after speed-decreasing section

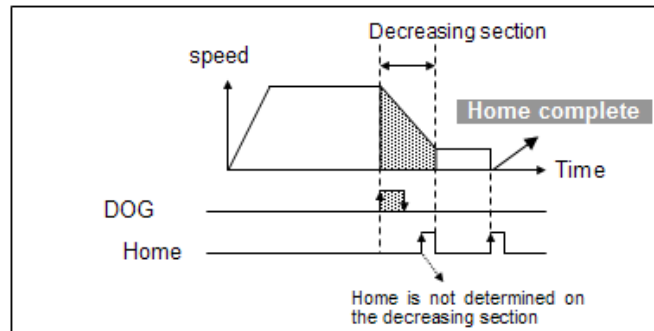

- It operates as follows if it meets an external lower limit while waiting for origin entry after DOG signal changes Off->On->Off. (The following figure is example when home direction is backward)

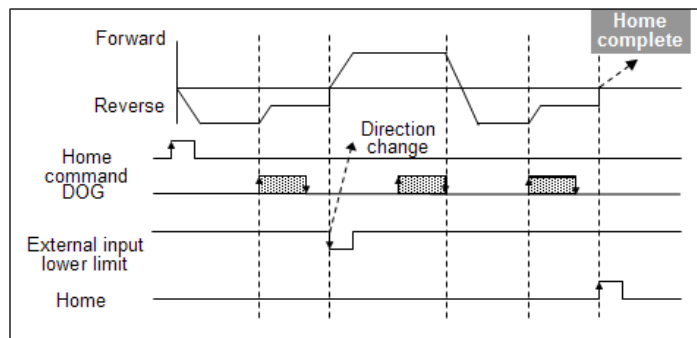

If object starts home return backward by homing command and meets rising edge of DOG, it changes homing with slow speed and if it meets falling edge again, it waits to determine the origin at the first origin signal.

At this status, if external low limit input signal (B contact point) is entered, target changes the direction and homing forward with high speed.

At the moment when target meets rising edge of DOG again and falling edge, target changes the direction to backward and repeats step (1), if origin signal is entered, origin is determined.

※ During homing, if external input upper or lower limit is entered, object changes direction promptly without deceleration section. When stepping motor is used, this may cause out of operation. So be careful.

- If 'On' time of origin input signal is very short, XGB may not recognize the input signal. So 'On' time of origin should be larger than 0.2ms.

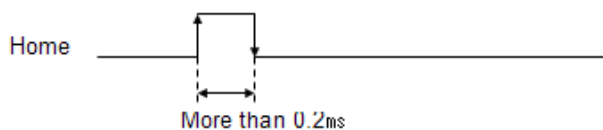

## (3) Origin detection after deceleration with DOG set "On"

Operations by home return instruction using DOG and origin signal are as follows.

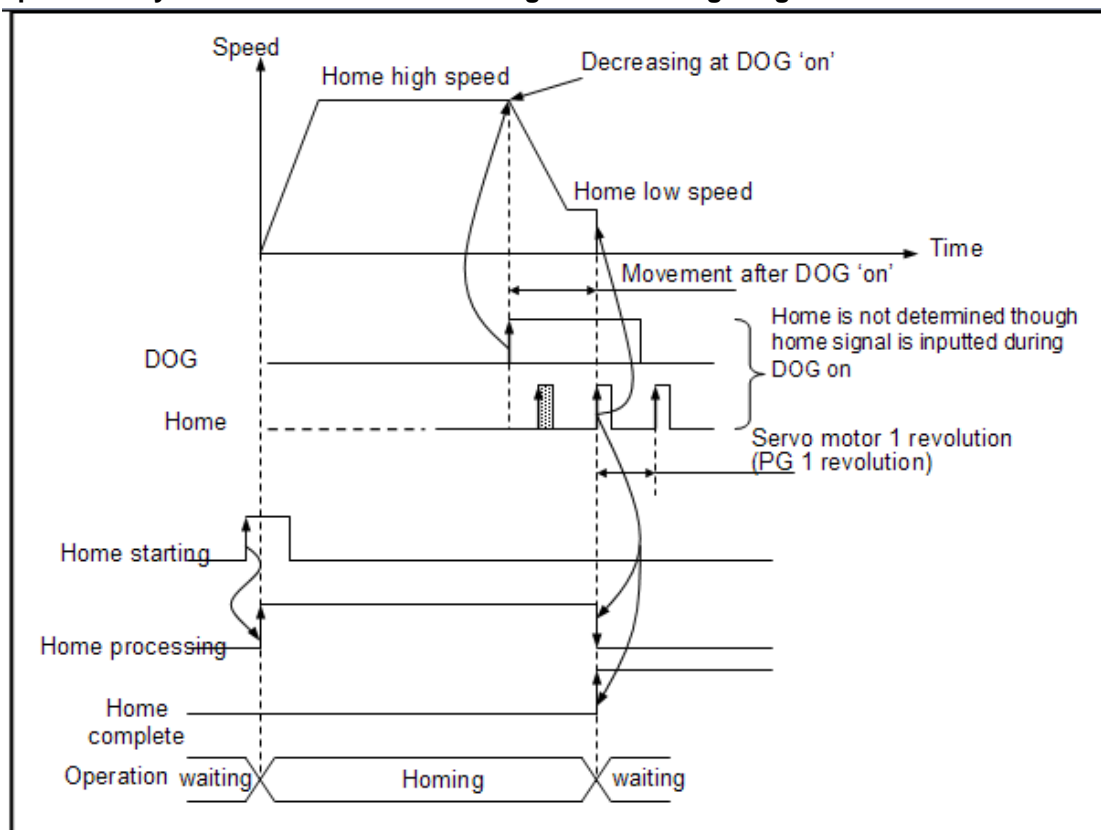

- If homing command(ORG instruction) is executed, it accelerates toward a set home direction and operates at home high speed.
- At the moment, if an external entry, DOG signal is entered, it decelerates and operates at home return low speed.
- Origin is determined and it stops if it meets an external entry, origin signal with DOG set "On" while it operates at home return low speed.

#### Remark

- Origin is determined if origin signal is entered with DOG set "On" as long as home return speed is operating at low speed from high speed via decelerating section with DOG signal set "On". That is, when home return speed is decelerating, origin is not determined by origin signal.
- If it meets external upper/lower limit signal prior to origin after DOG signal is changed from "Off" to "On", it works backward direction.

## (4) Origin detection by DOG

It is used when determining origin by using the only DOG.

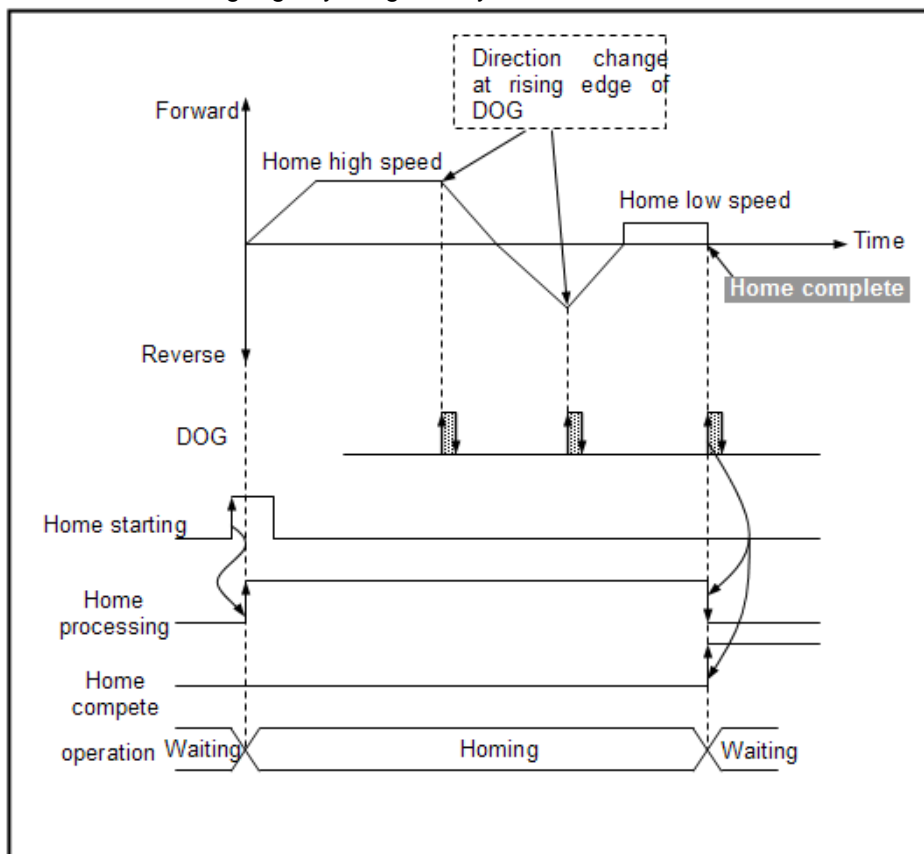

- If homing command (ORG instruction) is executed, it accelerates to home direction set in Home P parameter and it homes with high speed.  
(The above figure is example when homing direction is forward)
- While target is homing with high speed, if rising edge of DOG occurs, target speed decreases and change its direction.
- When it accelerates after changing direction, if rising edge of DOG occurs, it homes with low speed.
- In the homing status with low speed, rising edge occurs of DOG third time, it stops and determines the origin.
- When 'On' time of DOG signal is larger decreasing time, it changes the direction at the falling edge of DOG and moves with low speed and stops at the rising edge of DOG and determines the origin.

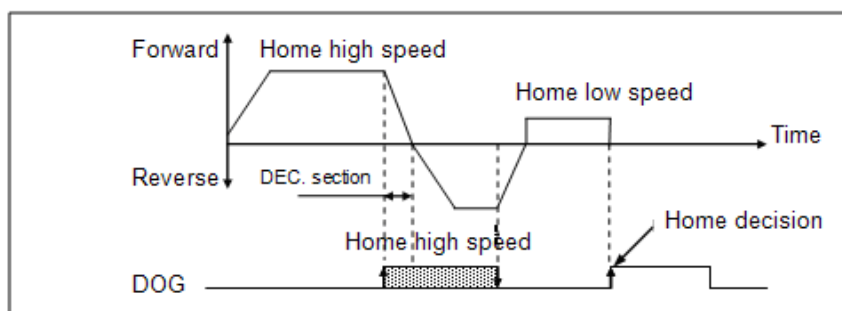

### 3.1.10 Position and speed override

•Override means changing target address or speed without stop during positioning.

The XGB positioning provides three type of override, position override, speed override, speed override with position.

#### (1) Position override

If changing a target position during positioning operation with positioning data, it may be changed by using position override command (POR instruction).

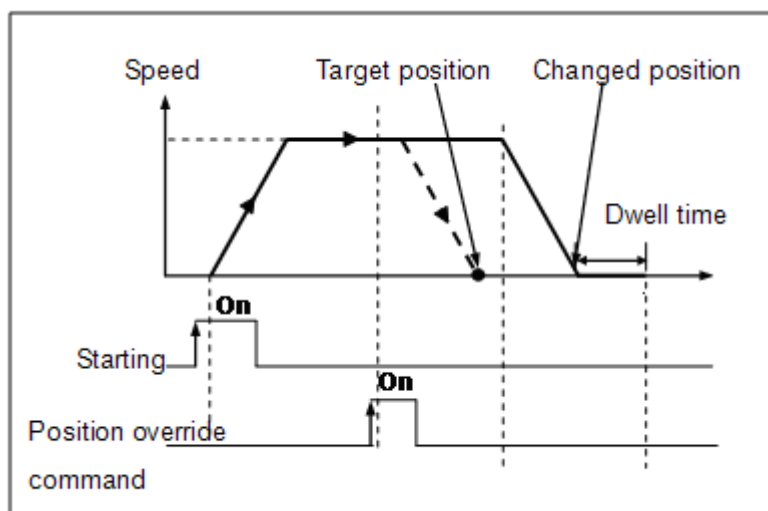

•When using position override, be careful the followings.

- (a) That is, if passing a position to change during operation, it decelerates, stops and keeps positioning operation by the subsequent operation pattern; if not passing a position, it starts positioning operation as taking a Incremental position as much as override set in the start point of the step of position override instruction.

(Ex.) It assumes that current location is 20,000 and operation data is specified as table below.

(It assumes that position override amount is 15,000)

Step no.	Coord.	Pattern	Control	Method	Rep step	Address [Pulse]	M Code	A/D No.	Speed [pls/s]	Dwell [ms]
3	ABS	END	POS	SIN	0	40,000	0	0	500	100

- 1) If operation step 3 starts, target moves to 40,000 by absolute coordinates forward.
  - 2) If override is executed at the time current position is 30,000 during operation, since it doesn't pass 15,000 based on operation start point 20,000 target position changes 35000 (20,000+15,000).
  - 3) If override is executed at the time current position is 38,000 during operation, since it passes 15,000 based on operation start point 20,000, target speed decreases and stops.
- (b) Position override command is available in the ACC., KEEP, DEC. section among operation pattern. If position override command is executed during dwell, error code 362 occurs.
- (c) In case operation pattern is set as CONT, override is executed based on start position of operation step used at this time.
- (d) Position override ranges  $-2,147,483,648 \sim 2,147,483,647$  Pulse.

## (2) Speed override

While positioning by operation data, it is used to change operation speed by speed override command (SOR instruction).

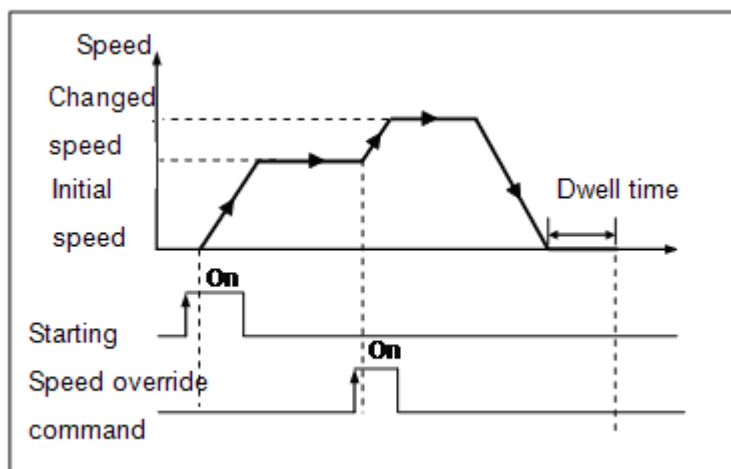

- Speed override command is available during acceleration, constant speed operation section and executing speed override instruction in deceleration section during operation or dwell section may cause Error 377 but the operation continues.
- Speed override setting ranges 1~100,000pps (setting unit: 1pps).

## Remark

- Note that if a sudden difference between the current speed used for operation and a new speed newly changed by speed override is excessive, it may cause a Step-over.
- During speed override, if target speed is smaller than bias speed, it will be operate by bias speed.

## (3) Speed override with position

Positioning speed override instruction changes its speed and keeps operating once it reaches the set position during positioning operation by using speed override with position (PSO instruction).

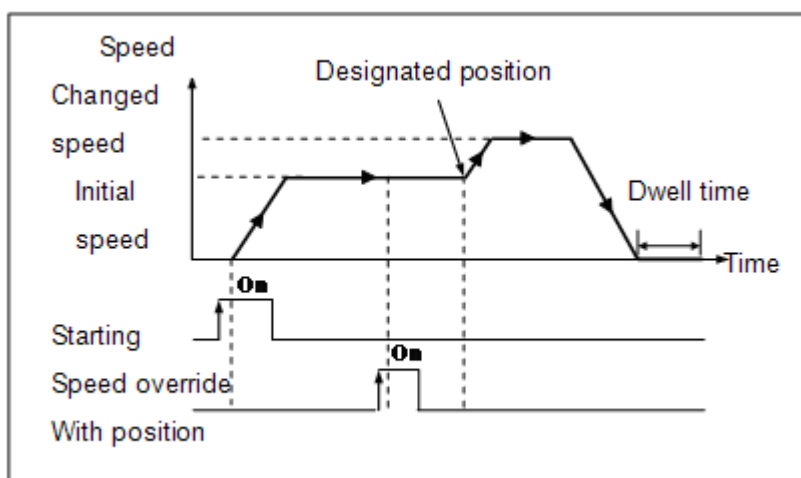

- Positioning speed override instruction is available only in acceleration and regular speed sections among operation patterns while the available operation modes are end operation, continuous operation and sequential operation.

### 3.1.11 Positioning stop signal

#### (1) Stop instruction and stop factors

- Stop instructions and factors are summarized as follows and divided into individual stop and simultaneous stop. Individual axis stop instructions or the stop factors affect the only axis (axes) of which stop instruction is "On" or stop factor exists. However, interpolation control operation axis stops if an axis is with stop instruction or stop factor during linear/circular interpolation.

Operation status		Positioning <sup>*1</sup>	Home <sup>*2</sup>	Jog operation	Axis operation status after stop instruction <sup>*3</sup>	M code "On" Signal status
Stop by parameter setting <sup>*4</sup>	Excess of soft upper limit	Immediate stop	Not detected	Immediate stop	Error status (Error 501)	No change
	Excess of soft lower limit	Immediate stop	Not detected	Immediate stop	Error status (Error 502)	No change
Stop by sequence program <sup>*5</sup>	Dec. stop instruction	Dec. stop	Dec. stop	Error 322 (keep running)	Decelerating	No change
	Emergency stop instruction	Immediate stop			Error status (Error 481) No output	Off
Stop by external signal	External upper limit "On"	Immediate stop		Forward immediate stop	Error status (Error 492) <sup>*6</sup>	No change
	External lower limit "On"	Immediate stop		Backward immediate stop	Error status (Error 493) <sup>*6</sup>	No change
Stop by monitoring package	Dec. stop instruction	Immediate stop	Immediate stop	Error 322 (keep running)	Stopping	No change

#### Remark

- \*1: Positioning refers to position control, speed control, position/speed switching control and speed/position switching position by positioning data.
- \*2: If Home Return is complete, DOG and Home Signal, which are external input signals, do not affect positioning control.
- \*3: If axial operation is 'no output' after being stopped, run a instruction to cancel 'No Output'. Then, No output is cancelled and error number is reset.
- \*4: Soft upper/lower limits by parameters are unavailable in speed control operation mode.
- \*5: Sequence program refers to XGB program method.
- \*6: Error 495 may occur depending on a rotation direction.



## (2) Stop Process and Priority

## (a) Stop Process

- Since positioning operation is not complete if it stops due to deceleration stop instruction, After Mode among M code modes is not "On" because it does not generate positioning completion signal.
- After then, if indirect start instruction (step number = current step number) is generated, Absolute method operation operates as much as the remaining distance of the current operation step yet output while Incremental method operation operates as much as the target distance.

## (b) Process of emergency stop and external input upper/lower limits

- If emergency stop instruction or external input upper/lower limits are input during positioning control, it stops positioning control and turns 'No output', generating an error.

## (c) Stop process priority

The priority of positioning module stop process is as follows.

**Decelerating stop < Immediate stop**

**Remark**

- In case of any immediate stop factor during decelerating stop, it processes as follow.

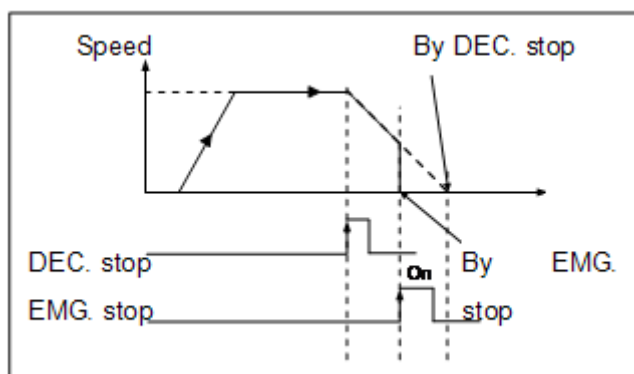

- Immediate stop factors: ①internal emergency stop, ②external input upper/lower limit, ③Soft upper/lower limits

## (d) Interpolation stop

- It decelerates and stops if it meets a stop instruction during interpolation operation.
- If indirect start instruction is executed in the current step when re-starting after decelerating stop, it resumes operating the positioning operation data to the target position. At the moment, it operates differently depending on absolute coordinate and Incremental coordinate.

## (e) Emergency stop

- It immediately stops if meeting emergency stop while performing start-related instructions (indirect start, direct start, simultaneous start, synchronic start, linear interpolation start, Home Return start, jog start and inching start).
- Internal emergency stop generates Error 481.
- Since it is subject to no output and un-defined origin once emergency stop is executed, it may run positioning operation after executing origin determination (Home Return, floating origin and the current position preset) in case it is operated with absolute coordinate or in determined origin.

### 3.1.12 Manual operation

In general, manual operations refer to jog operation, inching operation which don't use operation data.

#### (1) Jog operation

- Jog operation means positioning by jog operation stat contact point or positioning monitoring package.

Classification		Jog forward start	Jog backward start	Jog high speed/low speed
X axis	XBM/XBC	K4291	K4292	K4293
	XEC	%KX6865	%KX6866	%KX6867
Y axis	XBM/XBC	K4391	K4392	K4393
	XEC	%KX7025	%KX7026	%KX7027

- It is operated by jog speed set in positioning parameter.
- It can be executed when origin is not determined.
- Acceleration/deceleration process is controlled by the duration set in jog acceleration/deceleration time among parameter settings of this software package.
- If jog speed is set out of allowable range, it generates an error and operation is not available

Range	High speed jog operation	1 ~ 100,000	(Unit: 1pps)
	Low speed jog operation	1 ~ jog high speed	

#### Remark

- Make sure to follow the cautions

$$\text{Bias speed} \leq \text{Jog high speed} \leq \text{Speed limit}$$

#### (2) Inching operation

- As one of manual operations, it outputs as much as pulse set at the speed for origin/manual parameter inching speed.
- While operation by jog instruction may not exactly move to the start/end points, inching instruction may easily reach to a target point as much as desirable distance. Therefore, it is probable to move close to an operation position by jog instruction and then move to an exact target position by inching operation instruction.
- The available range is between  $-2,147,483,648 \sim 2,147,483,647$  Pulse.

### 3.1.13 Stroke Upper/Lower Limits

Positioning is subject to external input stroke limit (external input upper limit, external input lower limit) and software stroke limit (software upper limit, software lower limit).

#### (1) External input stroke upper/lower limits

- External input stroke limit is an external input connector of positioning; external input upper limit/external input lower limit.
- It is used to immediately stop a positioning module before reaching to stroke limit/stroke end by setting up stroke limits of positioning module inside stroke limit/stroke end of drives. At the moment, if exceeding upper limit, it generates Error 492 while if exceeding lower limit, it generates Error 493.

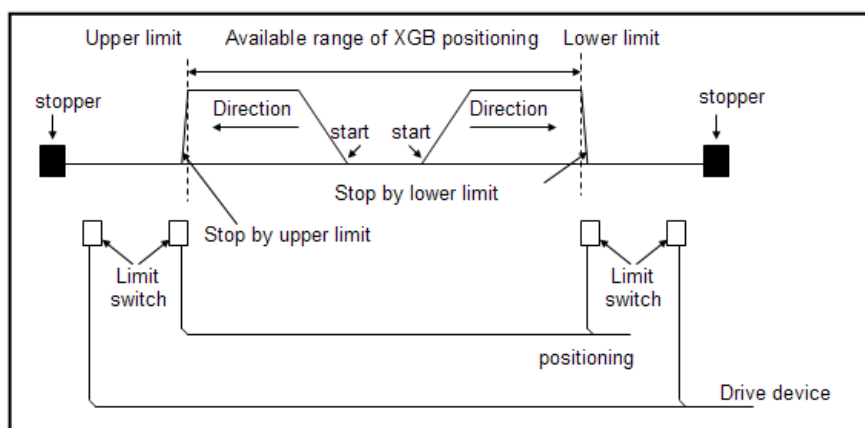

- Note that positioning operation is not available if it stops out of positioning range. If it stops due to external input stroke limit detection, move it into the controllable range of positioning by manual operation (jog operation, inching operation, manual pulse generator operation).
- External input stroke upper/lower limit error is detected by edge during positioning, so manual operation is available although it exceeds stroke range.

#### (2) Stroke upper/lower limits

- Stroke upper/lower limit function does not execute positioning operation if it is operated out of ranges of stroke upper/lower limits, which are set in positioning parameters.
- When it starts operation or is in operation, stroke upper/lower limits are checked.

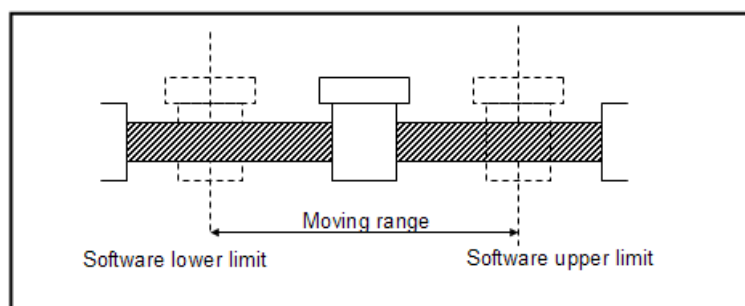

#### Remark

- Software stroke upper/lower limits are not detected unless origin is determined.

### 3.1.14 Output of positioning completion signal

- Regarding positioning completion output time, the completion signal(X axis: 4202, %KX6722, Y axis: K4 302, %KX6882) is on and it turns off after 'on' is maintained as much as 1 scan time after positioning is completed during single operation, repeat operation, continuous operation, sequential operation, linear interpolation operation, speed/position switching operation (with position indicated during constant speed operation) and inching operation.
- In case operation pattern is KEEP or CONT, positioning completion signal is yielded when operation pattern stops completely.
- The operations in single operation mode are as follows.

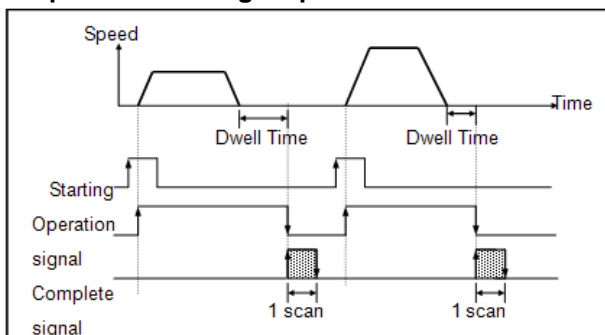

- The operations in continuous mode are as follows.

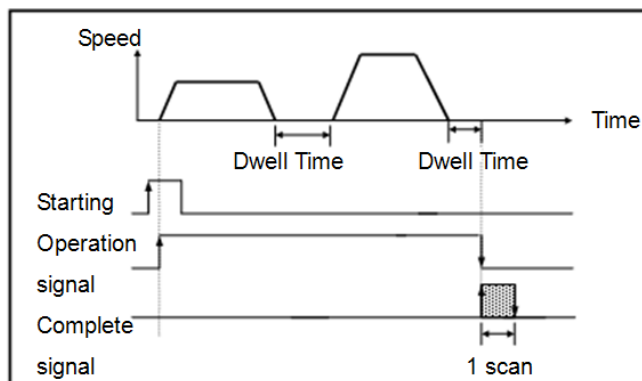

- The operations in sequential operation mode are as follows.

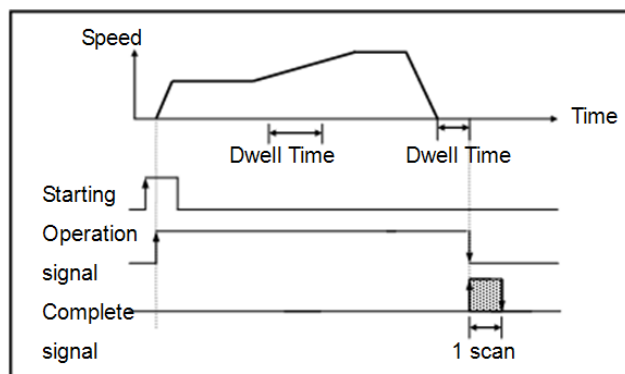

## 3.2 Positioning Parameter

It describes positioning parameter and operation data setting.

### 3.2.1 Positioning parameter setting sequence

- Positioning parameter can be set more than V1.2 (high end type can be set more than XG5000 V2.2) and it has the following sequence. (This manual is described by using XG5000 V2.2.)

(1) Opening parameter setting window

- Select [Parameter] -> [Embedded Parameter] -> [Positioning] and double-click to open positioning parameter setting window.  
(If project is not displayed, press [View] -> [Project Window] to open project window [shortcut key: ALT + 1])

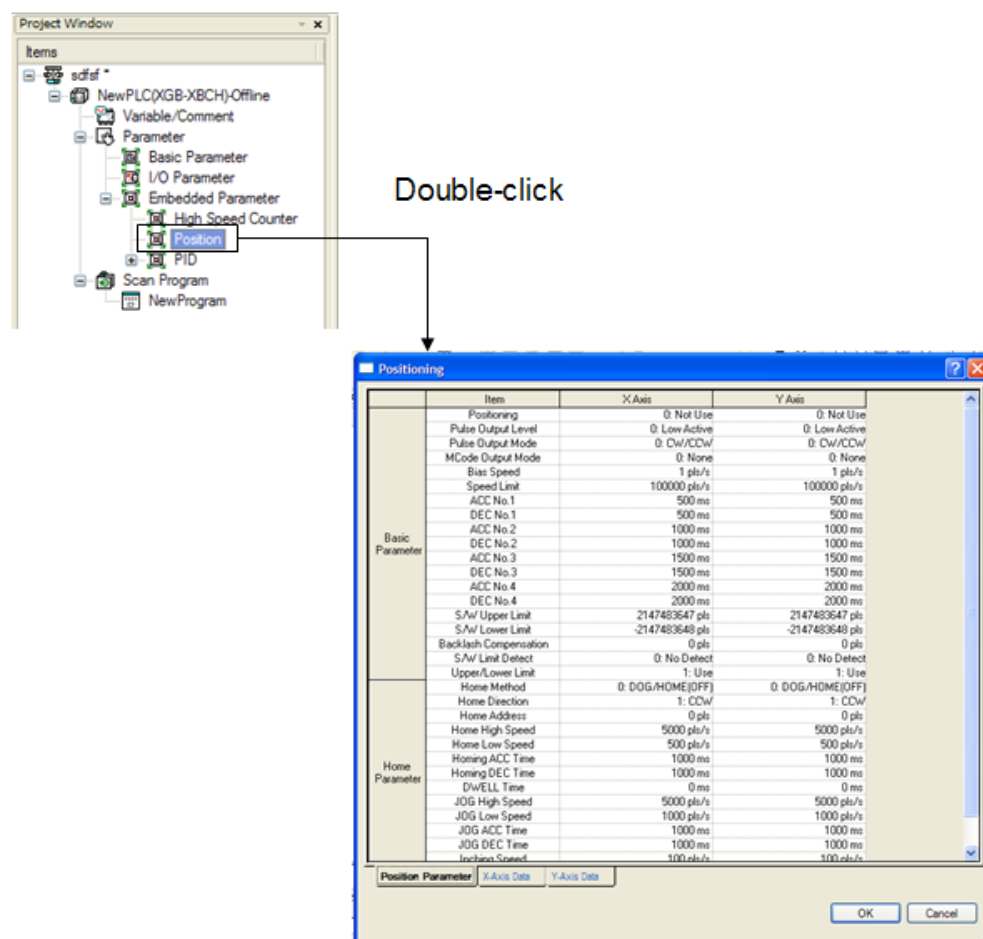

< Positioning parameter setting window >

## Chapter 3 Before Positioning

## (2) Setting parameter

- Positioning parameter setting window is classified into basic parameter and Home parameter.
- Each item can be set independently.
- For detail setting of basic parameter, refer to 3.2.3.
- For detail setting of Home parameter, refer to 3.2.4.

Type	Item	Description
Basic parameters	Positioning	Set whether to use positioning function.
	Pulse output level	Set pulse output mode (Low/High Active).
	Bias speed	Set the initial start speed for early operation.
	Speed limit	Set the max speed settable in positioning operation.
	ACC/DEC No.1	Time setting of ACC/DEC section No.1
	ACC/DEC No.2	Time setting of ACC/DEC section No.2
	ACC/DEC No.3	Time setting of ACC/DEC section No.3
	ACC/DEC No.4	Time setting of ACC/DEC section No.4
	SW upper limit	Set upper limit within a machine's operation range
	SW lower limit	Set lower limit within a machine's operation range
	Backlash compensation amount	Set compensation amount of tolerance in which a machine is not operated due to wear when rotation direction is changed.
	SW upper/lower limits during constant speed operation	Set whether to detect or not SW upper/lower limits during constant speed operation
	Use upper/lower limits	Use or not
Origin/Manual parameters	Home Return method	Set home return method
	Home Return direction	Set home return direction
	Origin address	Set origin address
	Origin compensation amount	Set origin compensation amount
	Home Return high speed	Set high speed for home return
	Home Return low speed	Set low speed for home return
	Home Return accelerating time	Set accelerating time for home return
	Home Return decelerating time	Set decelerating time for home return
	Dwell time	Set a time required to remove remaining bias counter immediately after positioning ends
	Jog high speed	Set high speed for jog operation
	Jog low speed	Set low speed for jog operation
	Jog accelerating time	Set accelerating time for jog operation
	Jog decelerating time	Set decelerating time for jog operation
	Inching speed	Set speed for inching operation

< Positioning parameter setting item >

## (3) Operation data setting

- If the user select 'X Axis Data' or 'Y Axis Data' tap on the positioning parameter setting window, the user can set operation data of 30 steps as show below.
- Standard type can set up to 30 steps, high-end type can set up to 80 steps.

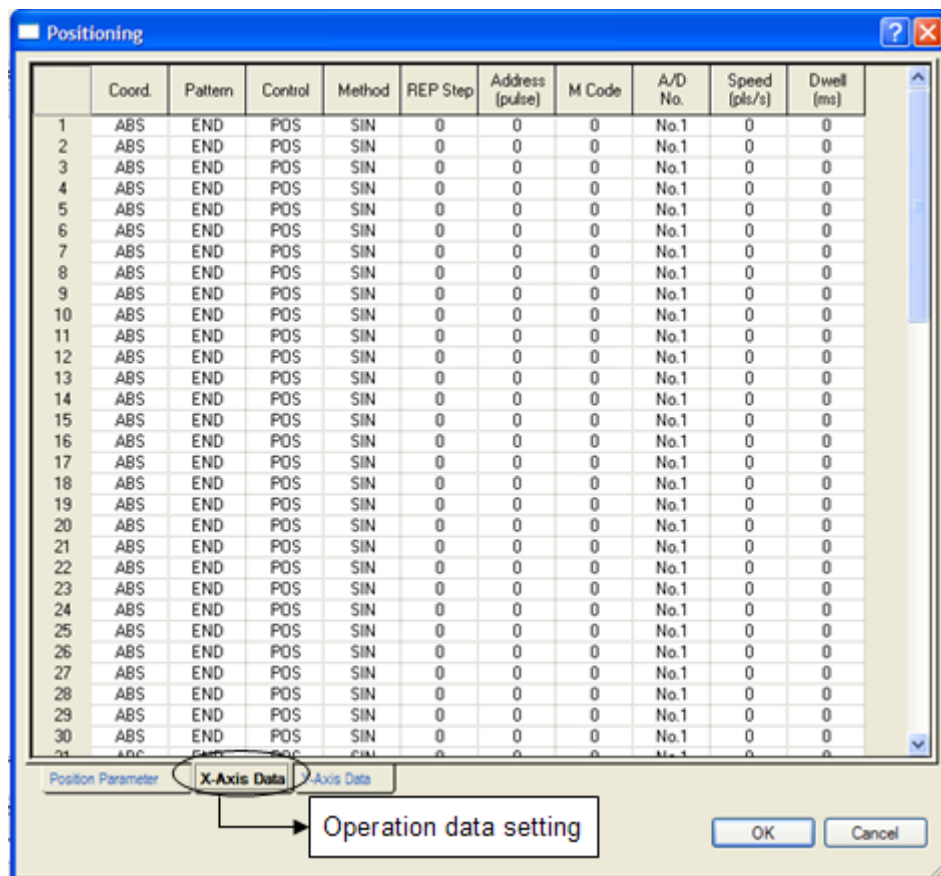

&lt; Position operation data setting window &gt;

- Items of operation data is as table below.
- For detail of operation data, refer to 3.3.

Item	Description	Initial value
Coord.	Setting Coord. of each step (ABS/INC)	ABS
Pattern	Setting operation pattern of each step (END/KEEP/CONT)	END
Control	Setting control method of each step (POS/SPD)	POS
Method	Setting operation method of each step (SIN/REP)	SIN
REP step	In case of repeated operation, setting the next step no.	0
Address	Setting target address of each step	0[Pulse]
M Code	In case of using M code, number indicated when M code occurred (In case of setting as 0, M code function is not used)	0
A/D No.	Setting A/D no. of each step	No.1
Speed	Operation speed of each step	0[pps]
Dwell	After ending step, time necessary to remove remaining pulse of offset counter	0[ms]

## Chapter 3 Before Positioning

### (4) Writing to PLC

- After setting of positioning parameter and operation data per each axis, download them to PLC
- Selecting [Online] -> [Write], 'Write' dialog box is displayed.  
In order to download parameter, select 'Parameter' and click 'OK'.

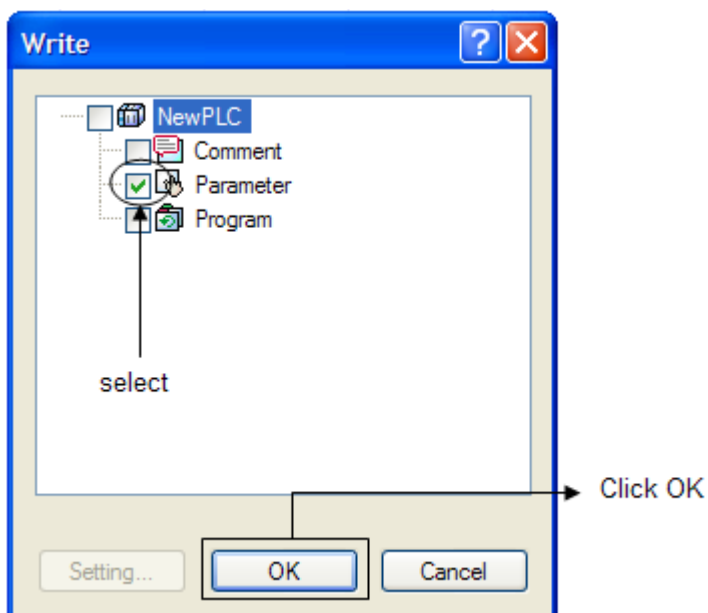

#### Remark

- If XG5000 is not connected with PLC, 'Write' menu is not activated. In case of this, select [Online] -> [Connect] to connect with PLC.
- When PLC is RUN mode, comment is available to download so only comment is displayed in the 'Write' dialog box. At this time, change PLC's mode to STOP and retry it.

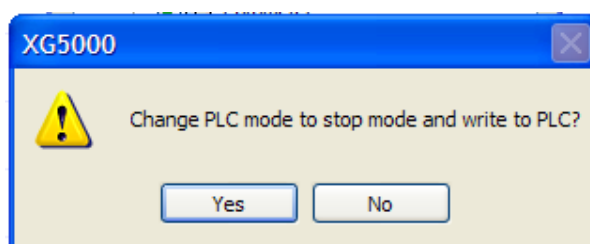

- If downloading parameter, basic parameter, I/O parameter, built-in parameter is transmitted.
- The downloaded positioning parameter is applied when turning on the power or changing operation mode. For more detail, refer to 3.2.2.



### 3.2.2 Relationship between positioning parameter and dedicated K area

XGB built-in positioning function executes the positioning control by using parameter and K area dedicated for positioning. Here describes relationship between positioning parameter and K area.

Internal memory configuration related with XGB built-in positioning is as follows.

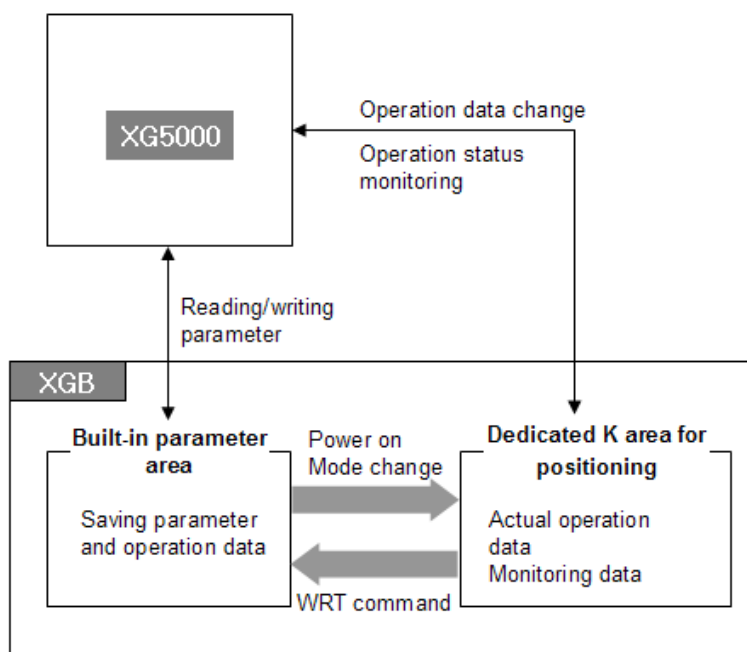

< Relationship between positioning parameter and K area >

- XGB has a built-in parameter area to save operation data and parameter written in the XG5000 and a dedicated K area for use of real positioning operation.
- If writing the embedded positioning parameter and operation data, the downloaded data is saved in the built-in parameter area permanently. And in case of reading, it reads built-in parameter area.
- XGB executes the initialization by copying the parameter and operation data saved in the built-in parameter area to K area dedicated for positioning.
  - (1) In case of restarting after power cut
  - (2) In case of changing PLC operation mode
  - (3) In case of restarting PLC by reset command
- XGB built-in positioning is executed by using data of K area and Flags that indicate the current operation status and monitoring data are displayed in the K area. So the user can change operation data easily by changing the K area data
- In order to preserve the current K area data, K area data should be applied to built-in parameter area by using application command (WRT command)
- For detail list of K area, refer to A2.2.

#### Remark

- After changing K area and not using WRT instruction, if restarting after power cut or changing PLC operation mode, K area is initialized.
- For more detail of WRT instruction, refer to 5.2.21.

### 3.2.3 Setting basic positioning parameters

It describes the range of setting basic parameters and special K area for positioning.

Item	Range	Initial value	K area for positioning		Data size
			X-axis	Y-axis	
			XBM/XBC	XBM/XBC	
			XEC	XEC	
Positioning	0: No use, 1 : use	0	K4870 %KX7792	K5270 %KX8432	Bit
Pulse output level	0 : Low Active, 1 : High Active	0	K4871 %KX7793	K5271 %KX8433	Bit
Pulse output mode	0 : CW/CCW 1 : PLS/DIR	0	K4873 %KX7795	K5273 %KX8435	Bit
M code output mode	0 : NONE, 1 : WITH 2 : AFTER	0	K4681-2 %KX7489-90	K5081-2 %KX8129-30	Bit
Bias speed	1 ~ 100,000[pulse/ sec]	1	K450 %KD225	K490 %KD245	Double word
Speed limit	1 ~ 100,000[pulse/ sec]	100,000	K452 %KD226	K492 %KD246	Double word
ACC time 1	0 ~ 10,000[unit: ms]	500	K454 %KW454	K494 %KW494	word
DEC time 1	0 ~ 10,000[unit: ms]	500	K455 %KW455	K495 %KW495	word
ACC time 2	0 ~ 10,000[unit: ms]	1,000	K456 %KW456	K496 %KW496	word
DEC time 2	0 ~ 10,000[unit: ms]	1,000	K457 %KW457	K497 %KW497	word
ACC time 3	0 ~ 10,000[unit: ms]	1,500	K458 %KW458	K498 %KW498	word
DEC time 3	0 ~ 10,000[unit: ms]	1,500	K459 %KW459	K499 %KW499	word
ACC time 4	0 ~ 10,000[unit: ms]	2,000	K460 %KW460	K500 %KW500	word
DEC time 4	0 ~ 10,000[unit: ms]	2,000	K461 %KW461	K501 %KW501	word
S/W upper limit	-2,147,483,648 ~ 2,147,483,647 [pulse]	2,147,483,647	K462 %KD231	K502 %KD251	Double word
S/W lower limit	-2,147,483,648 ~ 2,147,483,647 [pulse]	-2,147,483,648	K464 %KD232	K504 %KD252	Double word
Backlash Compensation	0 ~ 65,535[pulse]	0	K466 %KW466	K506 %KW506	word
S/W Limit Detect	0 : No detect1 : detect	0	K4684 %KX7492	K5084 %KX8132	Bit
Upper/lower limits	0: no use, 1: use	1	K4872 %KX7794	K5272 %KX8434	Bit

## (1) Positioning

- Determine whether to use positioning.
- If not using positioning function, set it '0: no use' while for use, it should be set to '1: use'.
- If setting it as '1: use', though it doesn't execute the instruction related with positioning, it is controlled by positioning.  
So in this case, though the user turns on this contact point by other application instruction, only output image data of XG5000 monitoring window is on and real output contact point doesn't turn on.

## Remark

- Make sure to set it '1: use' to use positioning.  
If using the instruction related with positioning when it is set as '0: no use', error code 105 occurs.

## (2) Pulse output level

- For pulse output level, select either of 'Low Active output' or 'High Active output'.
- For Low Active output, set as 0, for High Active output, set as 1.
- The following figure shows output pulse type in case of Low Active and High Active output based on X axis. (in case of Y axis, pulse string output: P21, direction output: P23)

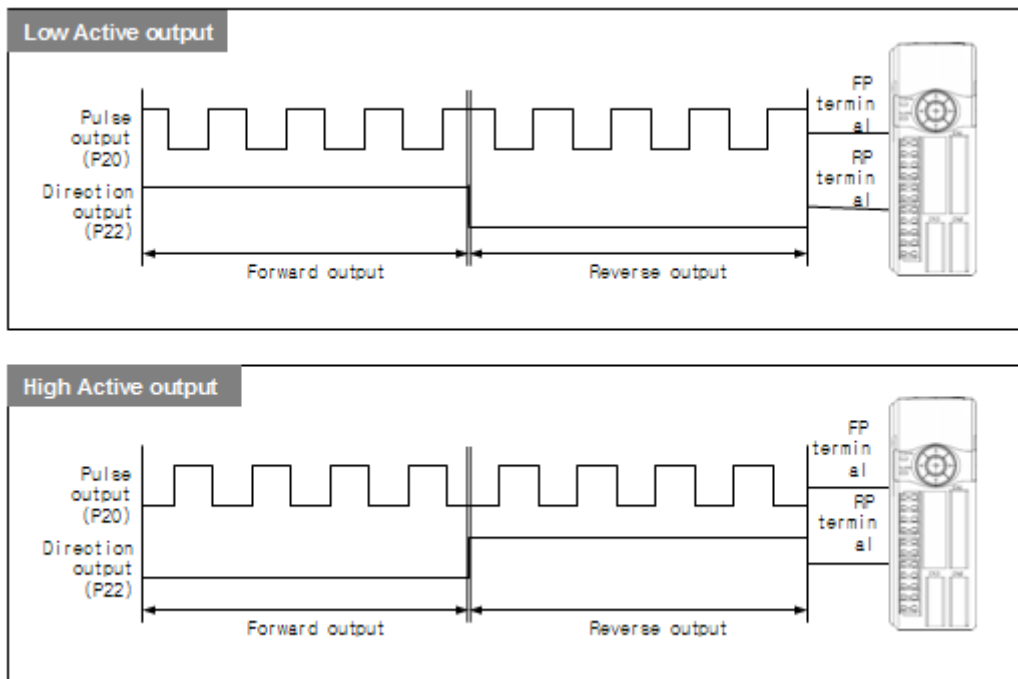

## (3) Bias speed

- Considering that torque of stepping motor is unstable when its speed is almost equal to 0, the initial speed is set during early operation in order to facilitate motor's rotation and is used to save positioning time. The speed set in the case is called 'bias speed'.
- In case of XGB built-in positioning, setting range of bias speed is 0 ~ 100,000 (unit:pps).
- Bias speed may be used for
  - (a) Positioning operation by start instruction (IST,DST,SS etc.)
  - (b) Home operation, JOG operation
  - (c) Main axis of interpolation operation(not available for sub axis)

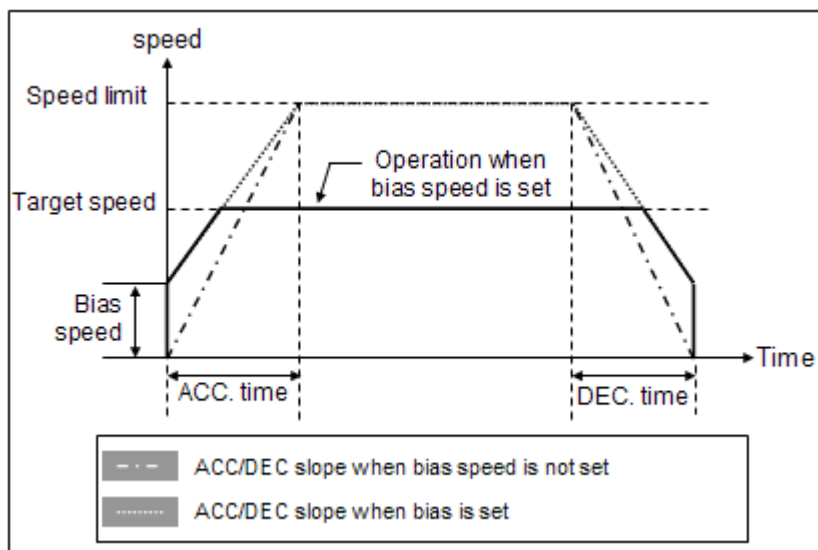

< Operation when setting bias speed >

- The figure above shows operation when setting bias speed. The entire operation time may be advantageously reduced if bias speed is highly set, but excessive value may cause impact sound at the start/end time and unreasonable operation on a machine.
- Bias speed should be set within the following range.
  - (a) Bias speed  $\leq$  Positioning speed
  - (b) Bias speed  $\leq$  Home Return low speed  $\leq$  Home Return high speed
  - (c) Bias speed  $\leq$  JOG high speed

→ (If home return speed is set lower than bias speed, it generates Error 133; if operation speed is set lower than bias speed during positioning, it generates Error 153; if JOG high speed is set lower than bias speed, it generates Error 121.)

#### (4) Speed limit

- It refers to the allowable max speed of positioning operation.
- In Pulse unit, the range is between 1 ~ 1,000,000(unit: pps).
- During position operation, operation speed, home return speed and jog operation speed are affected by speed limit, and if they are set higher than speed limit, it detects error.
  - (1) If home return speed is higher than speed limit : Error 133
  - (2) If positioning speed is higher than speed limit : Error 152
  - (3) If jog operation speed is higher than speed limit : Error 121

#### (5) ACC/DEC time

- It is applied to sequential operation instruction, speed override, positioning speed override during positioning operation as well as start/end time of positioning operation. At this time, ACC and DEC time is defined as shown below.
  - (a) ACC time: a duration required to reach from "0(stop)" speed to the speed limit set in parameter.  
Using bias would be a time consumed to reach from bias speed set to the speed limit set in parameter.
  - (b) DEC time: a duration required to reach from the speed limit set in parameter up to "0"(stop) speed.  
Using bias would be a time consumed to reach from bias speed set to the speed limit set in parameter.

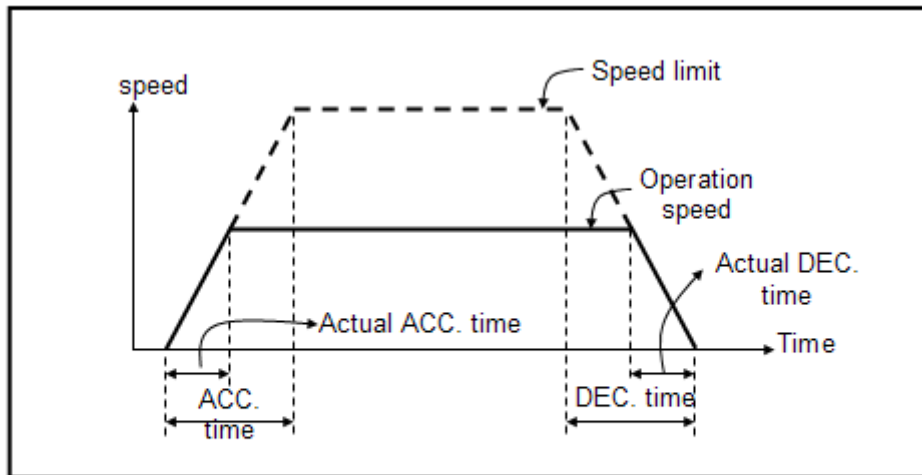

**ACC. time :** Time to take from stop status to speed limit

**Actual ACC. time:** Time to take from stop status to operation speed

- The range is between 0 ~ 10,000 (unit: 1ms) per axis.
- ACC/DEC time is set with 4 types and it can be set differently according to each operation data.

#### (6) SW Upper/Lower Limit

- A range of a machine's move is called 'stroke limit', and it sets the upper/lower limits of stroke into software upper limit and software lower limit and does not execute positioning if it operates out of ranges set in the above. Therefore, it is used to prevent against out-of-range of upper/lower limits resulting from incorrect positioning address or malfunction by program error and it needs installing emergency stop limit switch close to a machine's stroke limit.
- Except SW upper limit and lower limit, install limit switch for emergency stop near stroke limit of machine.

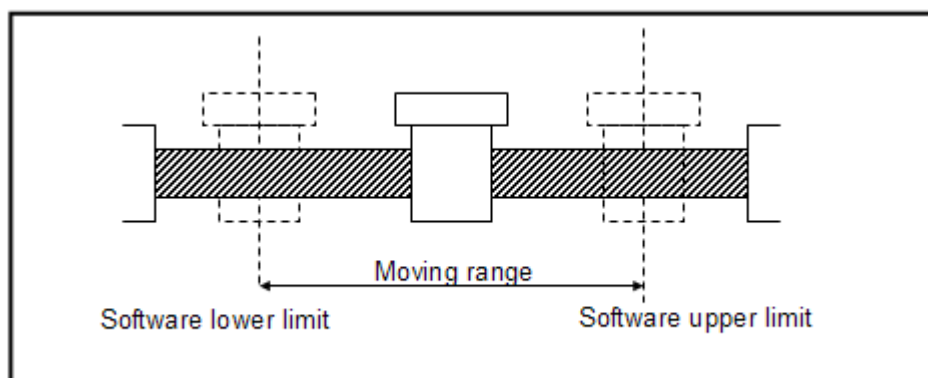

- Range of SW upper limit and lower limit is checked when starting positioning and operating.
- If an error is detected by setting software upper/lower limits (software upper limit error: 501, software lower limit error: 502), pulse output of positioning module is prohibited. Therefore, to resume operation after an error is detected, it is prerequisite to cancel 'No output'. (No output status is displayed at K4205(%KX6725), for X axis and K4305(%KX6885) for Y axis.

- It can be set according to each axis and range is as follows.
  - SW upper limit address value range: -2,147,483,648 ~ 2,147,483,647 (unit: Pulse)
  - SW lower limit address value range: -2,147,483,648 ~ 2,147,483,647 (unit: Pulse)

### (7) Backlash Compensation Amount

- A tolerance that a machine does not operate due to wear when its rotation direction is changed if it is moving with motor axis combined with gear and screw is called 'backlash'.
- Therefore, when changing a rotation direction, it should output by adding backlash compensation amount to positioning amount.
- The range is between 0 ~ 65,535(unit: Pulse) per axis.
- It is available for positioning operation, inching operation and jog operation

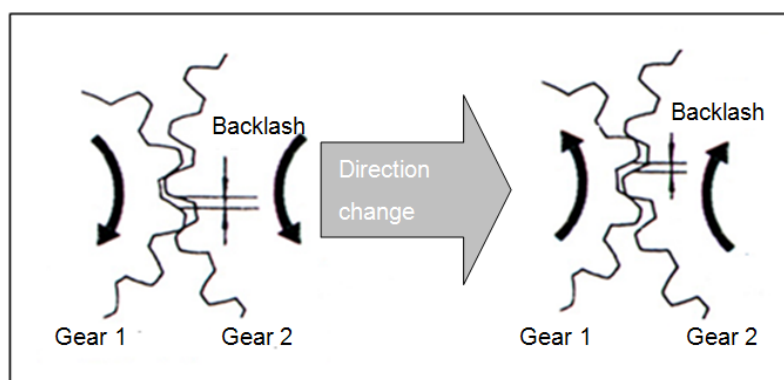

- Backlash compensation outputs backlash compensation amount first and then, address of positioning operation, inching operation and jog operation move to the target positions. (At this time, output as many as backlash amount is not added to the current position address.)

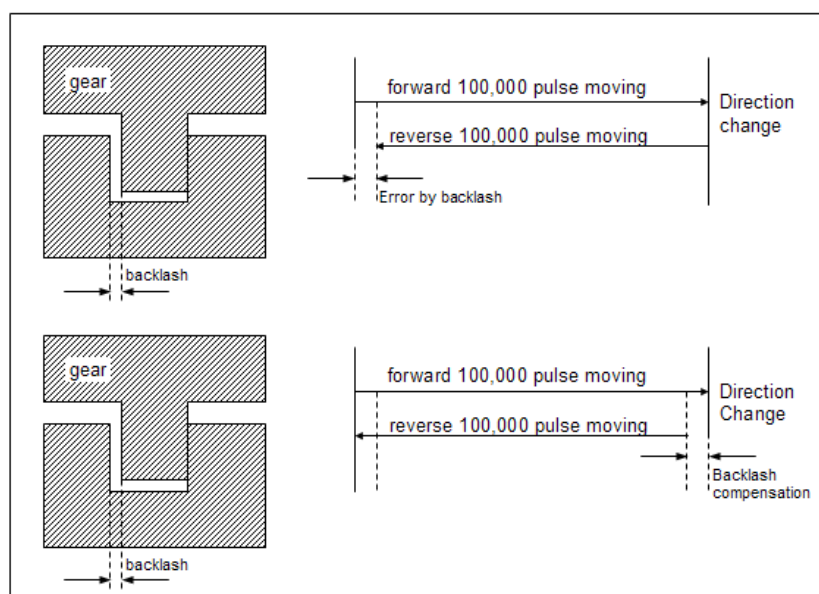

- The above figure describes difference of backlash setting or no backlash setting.

In case of not setting backlash compensation amount, it moves as many as 100,000 pulse forward and changes the direction and moves backward as many as 100,000 pulse. It may cause error by backlash. For example, it assumes that backlash is 500 pulse, in case of not setting backlash, final stop location is 500. To compensate this, setting backlash compensation as 500, when changing the direction, 100,500 pulse is yielded adding 500 pulse set as backlash compensation amount. So target stops at the precise stop position.

- The following table indicates real pulse output and stop position in case of setting backlash.

(Absolute coordinates is used.)

Operation step	Backlash setting amount	Target address	Direction conversion	Real output pulse	Stop position
1	500	10,000	X	10,000	10,000
2		30,000	X	20,000	30,000
3		0	o	-30,500	0

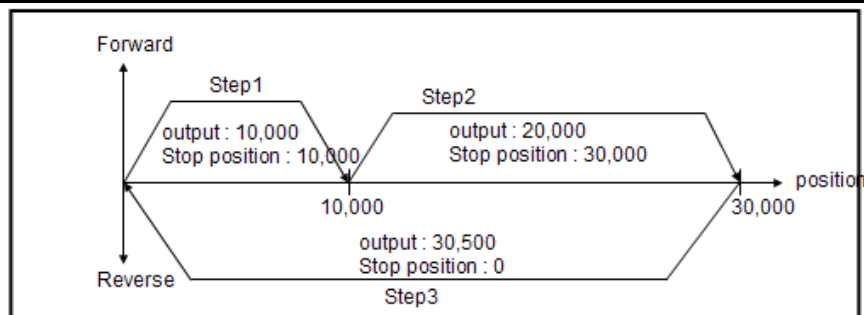

#### Remark

- Once backlash compensation amount is set or changed, home return should be executed otherwise there can be error at the current position by backlash compensation amount.

#### (8) SW upper/lower limits during constant speed operation

- It is used to stop pulse output by SW upper/lower limit detection during constant speed operation by speed control.
- In the case, SW upper/lower limit detection is available as long as origin is set and the position mark during constant speed operation is "Mark"

#### (9) Use of Upper/Lower Limits

- To use upper/lower limits during operation, it should be set as "Use".
- Upper/Lower limit input contact point is fixed as the table below and it can be used as normally closed contact point (B contact point).
- If 'No use' is set, it does not detect upper/lower limits and is available with general input contact.

Signal name	Input contact point number			Operation content	Reference
	X axis	Standard	High end		
External low limit signal (LimitL)	X axis	P0000	P0008	Detects the X axis external lower limit at the rising edge of input contact point	Acts as normally closed contact point (B contact point)
	Y axis	P0002	P000A	Detects the Y axis external lower limit at the rising edge of input contact point.	
External upper limit signal (LimitH)	X axis	P0001	P0009	Detects the X axis external upper limit at the rising edge of input contact point.	
	Y axis	P0003	P0008	Detects the Y axis external upper limit at the rising edge of input contact point.	

### 3.2.4 Origin/Manual Parameter Setting for Positioning

Here describes setting range, method of origin/manual parameter for positioning, and special K area for positioning corresponding to each item. They are summarized as the table below.

Item	Setting range	Initial value	Dedicated K area		Data size
			X axis XBM/XBC XEC	Y axis XBM/XBC XEC	
Home Return method	0 : origin detection after DOG off 1 : origin detection after deceleration when DOG is On 2 : origin detection by DOG	0	K4780-81 %KX7648-49	K5180-81 %KX8288-89	2 Bit
Home Return direction	0 : forward, 1 : backward	1	K4782 %KX7650	K5182 %KX8290	Bit
Origin address	-2,147,483,648 ~ 2,147,483,647 [pulse]	0	K469 %KD234	K509 %KD254	Double word
Home Return high speed	1 ~ 100,000 [pulse/]	5,000	K471 %KD235	K511 %KD255	Double word
Home Return low speed	1 ~ 100,000 [pulse/]	500	K473 %KD236	K513 %KD256	Double word
Home Return ACC time	0 ~ 10,000 [unit: ms]	1,000	K475 %KW475	K515 %KW515	Word
Home Return DEC time	0 ~ 10,000 [unit: ms]	1,000	K476 %KW476	K516 %KW516	Word
Dwell time	0 ~ 50,000 [unit: ms]	0	K477 %KW477	K517 %KW517	Word
Jog high speed	1 ~ 100,000 [pulse/]	5,000	K479 %KD239	K519 %KD259	Double word
Jog low speed	1 ~ 100,000 [pulse/]	1,000	K481 %KD240	K521 %KD260	Double word
Jog ACC time	0 ~ 10,000 [unit: ms]	1,000	K483 %KW483	K523 %KW523	Word
Jog DEC time	0 ~ 10,000 [unit: ms]	1,000	K484 %KW484	K524 %KW524	Word
Inching speed	1 ~ 65,535 [pulse/]	100	K485 %KW485	K525 %KW525	Word

#### (1) Home Return method

- There are three home return methods as follows.
  - a) DOG/Origin(Off) :  
-If origin signal is inputted, it detects the origin signal after DOG changes On -> Off.
  - b) DOG/Origin(On) : When DOG is on, it detects the origin after deceleration  
-If DOG signal is on and origin signal is inputted after deceleration, it detects the origin.
  - c) DOG :  
-It detects the origin by using DOG signal.
- For more detail of home return method, refer to 3.1.9.

#### (2) Home Return direction

- Home Return direction is divided into CW(forward) and CCW(backward) depending on pulse output direction.



Setting value	Home Return direction	Pulse output operation of XGB positioning module
0	Forward	Executing forward home return.
1	Backward	Executing backward home return.

## (3) Origin address

- It is used to change the current address to a value set in home return address when home return is completed by home return instruction.
- setting range: -2,147,483,648 ~ 2,147,483,647 (unit: Pulse)

## (4) Home Return high speed

- As a speed when it returns home by home return instruction, it is divided into high speed and low speed.
- It refers to a speed operating in regular speed section via accelerating section by home return instruction.
- The range of home return high speed is between 1 ~ 100,000(unit: pps)

## (5) Home Return low speed

- It refers to a speed operating in regular speed section via decelerating section from home return high speed by home return instruction.
- The range of home return low speed is between 1 ~ 100,000(unit: pps)

## Remark

- When setting home return speed, it should be "speed limit  $\geq$  home return high speed  $\geq$  home return low speed".
- It is recommended to set home return low speed as low as possible when setting home return speed. Origin signal detection may be inaccurate if low speed is set too fast.

## (6) Home Return ACC/DEC time

- When it returns home by home return instruction, it returns home at the speed of home return high speed and home return low speed by ACC/DEC time.
- The range of home return ACC/DEC time is between 0 ~ 10,000(unit: 1ms).

## (7) Dwell time

- It sets Dwell time applied to Home Return
- Dwell time is necessary to maintain precise stop of servo motor when positioning by using a servo motor.
- The actual duration necessary to remove remaining pulse of bias counter after positioning ends is called 'dwell time'.
- The range of home return dwell time is between 0 ~ 50,000 (unit: 1ms)

## (8) JOG high speed

- Jog speed is about jog operation, one of manual operations and is divided into jog low speed operation and jog high speed operation.
- Jog high speed operation is operated by patterns with accelerating, regular speed and decelerating sections. The refore, job is controlled by ACC/DEC instruction in accelerating section and decelerating section.
- The range of jog high speed is between 1 ~ 100,000(unit: 1pps)

## (9) JOG low speed

- Jog low speed operation is operated with patterns of accelerating, regular speed and decelerating sections.
- The range of jog low speed is between 1 ~ 100,000 (unit: 1pps)

## Remark

- When setting JOG high speed, it should be "Speed limit  $\geq$  JOG high speed  $\geq$  Bias speed".
- When setting JOG low speed, it should be smaller than JOG high speed.

## (10) JOG ACC/DEC time

- It refers to JOG ACC/DEC time during jog high/low speed operation.
- The range of JOG ACC/DEC time is between 0 ~ 10,000 (unit: 1ms)

## (11) Inching speed

- The inching operation speed is set.
- The range of inching speed is between 1 ~ 65,535 (unit: 1pps)
- For detail of inching operation, refer to 3.1.12.

### 3.3 Positioning Operation Data

It describes operation data for XGB positioning. If the user select 'X axis data' or 'Y axis data' tap in the positioning parameter setting window, the following figure is displayed. Each axis can have 30~80 (standard type: 30 steps, compact stand/high-end type: 80steps) steps of operation data.

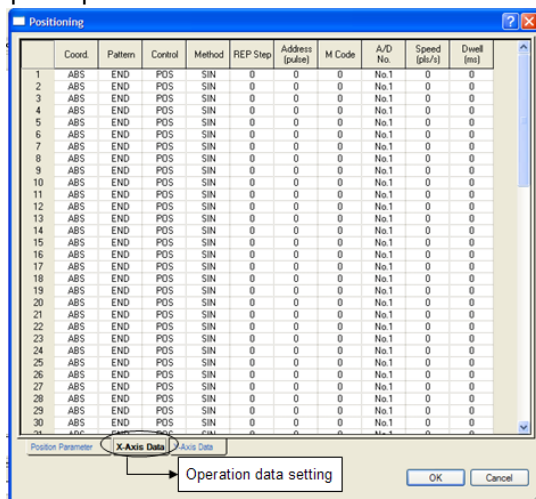

Each of item can have a following data.

Step	Item	Range	Initial values	Device area		Remarks
				X-axis	Y-axis	
1	Coord.	0 : ABS, 1 : Incremental	ABS	K5384	K8384	Bit
	Pattern	0 : end, 1 : continuous, 2 : sequential	End	K5382~3	K8382~3	Bit
	Control	0 : position control, 1 : speed control	Position	K5381	K8381	Bit
	Method	0: single, 1 : repeat	Single	K5380	K8380	Bit
	REP	0~30(High end 0~80)	0	K539	K839	Word
	Address(pulse)	-2,147,483,648 ~ 2,147,483,647 [pulse]	0	K530	K830	Double word
	M Code	0 ~ 65,535	0	K537	K837	Word
	A/D No.	0 : No.1, 1 : No.1, 2 : No.3 3 : No.4	0	K5386-87	K8386-87	Bit
	Speed	1 ~ 100,000[pulse/sec]	0	K534	K834	Double word
Dwell time	0 ~ 50,000[unit: ms]	0	K536	K836	Word	
2	Same item with No.1 step			K540~549	K840~849	
3~30	Same item with No.1 step			K550~829	K850~1129	
31	Same item with No.1 step			K2340~2349	K2840~2849	Only for high end type
32~80	Same item with No.1 step			K2350~2839	K2850~3339	

#### (1) Step number

- The range of positioning data serial number is between 1 ~ 30. (compact standard/high-end type is 1~80)
- When executing indirect start, simultaneous start, linear interpolation operation, position synchronization and etc., if you designates the step number of data to operate, it operates according to positioning dedicated K area where operation data is saved.
- If step number is set as 0, operation step indicated at the current step number (X axis: K426(%KW426), Y axis: K436(%KW436)) of positioning monitor flag is operated.

**Remark**

- The user can use variable of dedicated K area per each step easily by using Register U Device. For detail of monitor registration of positioning, refer to XG5000 user manual.

## (2) Coordinates

- Here sets the coordinates method of relevant operation step data.
- Coordinates methods selectable are absolute coordinate and Incremental coordinate.
- For more detail, refer to 3.1.2.

## (3) Operation pattern (END/KEEP/CONT) and operation method (SIN/REP)

- The user can select one pattern among three operation patterns per step. It can configure how to use the positioning operation data.
- Operation pattern can be set as follows according to Control and Method on the operation data.

Control	Method	Pattern	Reference
POS	SIN	END	
		KEEP	
		CONT	Linear interpolation is not available
	REP	END	
		KEEP	
		CONT	Linear interpolation is not available
SPD	SIN	END	Linear interpolation is not available
		KEEP	Linear interpolation is not available
		CONT	Not available
속도 제어	REP	END	Linear interpolation is not available
		KEEP	Linear interpolation is not available
		CONT	Not available

- In case Method is set as SIN, the next operation step become 'current operation step + 1'. And in case Method is set as REP, the next operation step become the step set in REP Step.

## (a) END (SIN)

- It refers to execute the positioning to target address by using the data of operation step and complete the positioning after dwell time.

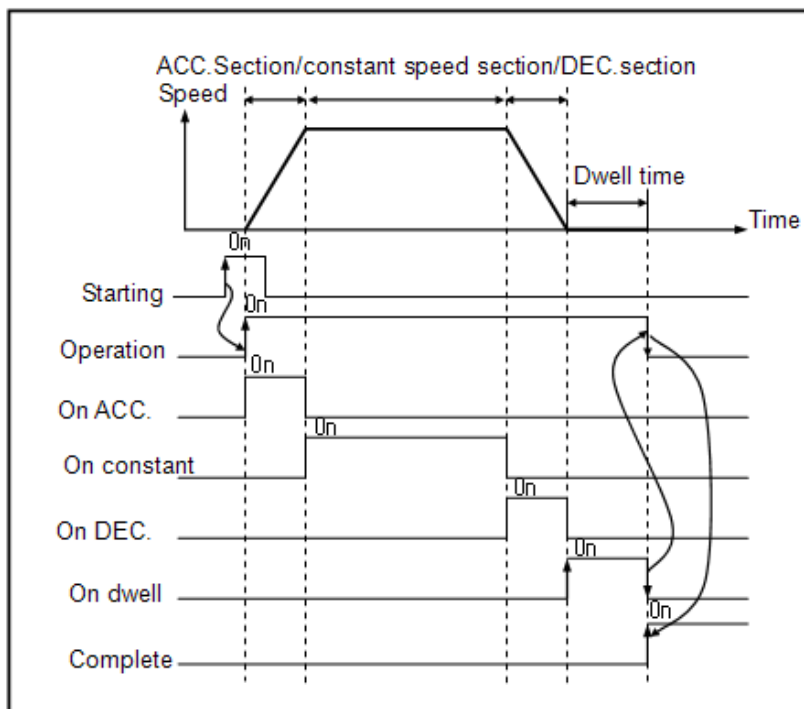

- Generally with END operation, position operation is executed according to pre-arranged speed and position like above picture as ladder shape with accelerated, constant, and decelerated intervals. However depending on position and speed settings, special shapes besides a ladder can be witnessed as below.

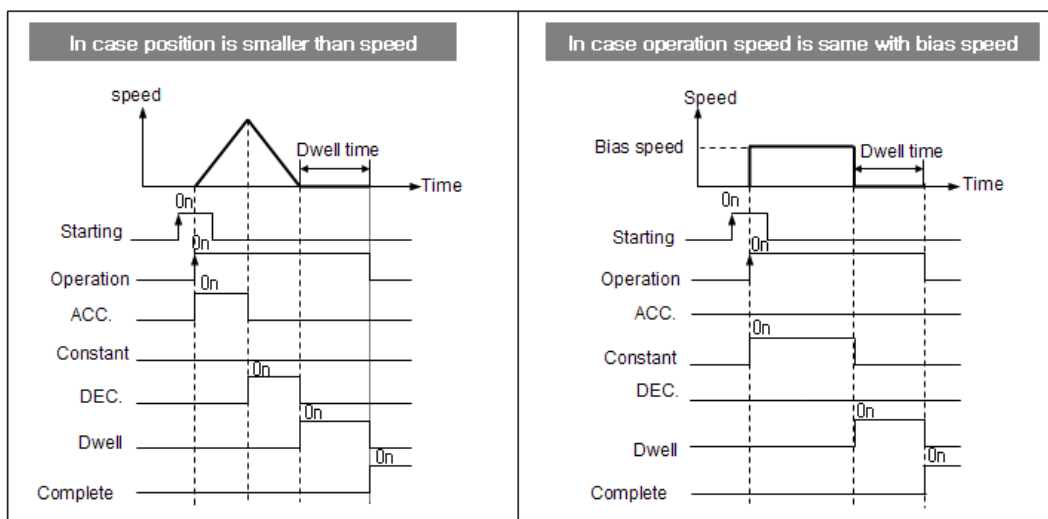

- In case target address is far less than speed, it can't pass the acceleration - regular speed - deceleration section. In this case, the positioning is complete without regular speed section.
- In case operation speed is same with bias speed, target moves with regular speed (bias speed) and it stops without deceleration section.

- It assumes that operation data is as follows to describe END/SIN operation.

Step no.	Coord.	Pattern	Control	Method	REP Step	Address [Pulse]	M code	A/D No.	Speed [pls/s]	Dwell [ms]
1	ABS	END	POS	SIN	0	10,000	0	1	1,000	100
2	ABS	END	POS	SIN	0	20,000	0	1	500	100
3	ABS	END	POS	SIN	0	30,000	0	1	1,000	100

- In the above table, operation pattern is set as END, target moves once by once start command and since Method is set as SIN, the next step becomes 'current operation step + 1'.
- To operate the next step, one more start command is necessary.

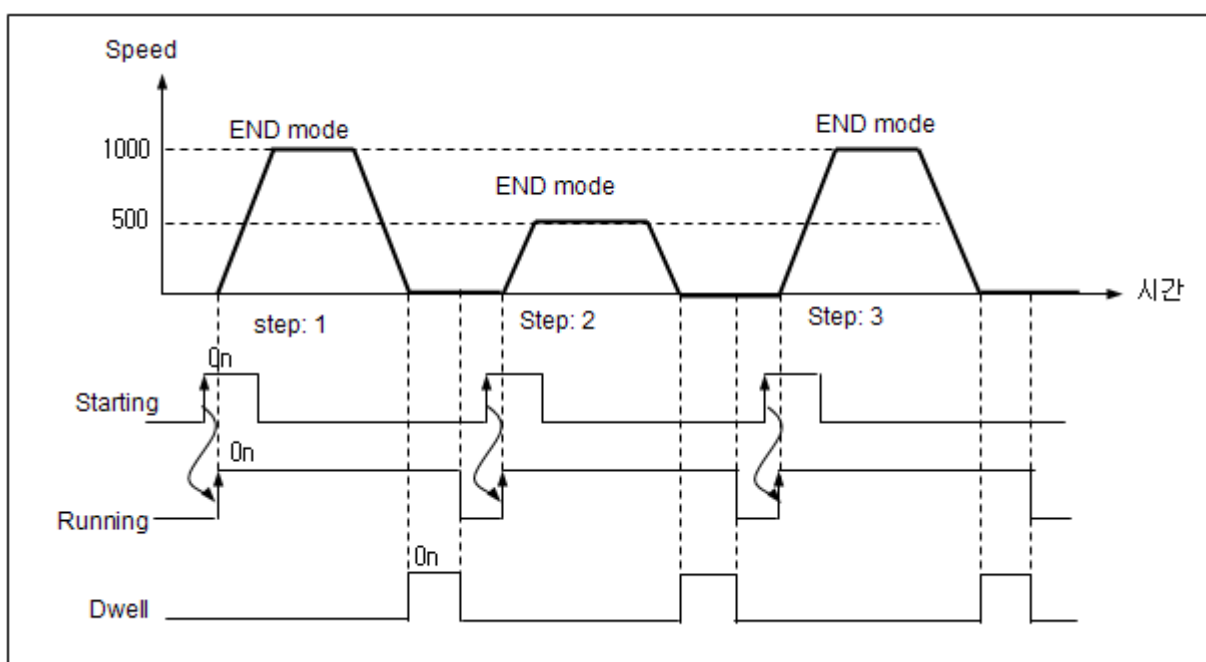

#### (b) END operation (Repetition)

- In case END operation (repetition), operation of currently started operation is same with END operation (single). But, The next step becomes the step set in the REP Step, which is different with END operation (single).
- It assumes that operation data is set as follows to describe END/Repetition.

Step No.	Coord.	Pattern	Control	Method	REP Step	Address [Pulse]	M code	A/D No.	Speed [pls/s]	Dwell [ms]
1	ABS	END	POS	SIN	0	10,000	0	1	1,000	100
2	ABS	END	POS	REP	1	20,000	0	1	500	100
3	ABS	END	POS	SIN	0	30,000	0	1	1,000	100

- By first start command, target moves to 10,000 pulse with 1,000pps speed and stops. At this time, since Method is SIN, the next operation step becomes the no.2 step, current operation step +1.
- By second start command, target moves to 20,000 with 500pps and stops. At this time, Method is REP, the next operation step becomes no.1 step set in REP Step, not no.3 step.
- If third start command is inputted, target moves to 10,000 ABS coordinates with 1,000 pps.
- Like this, no.1 step and no.2 step are repeated whenever start command is executed so no.3 step is not operated.

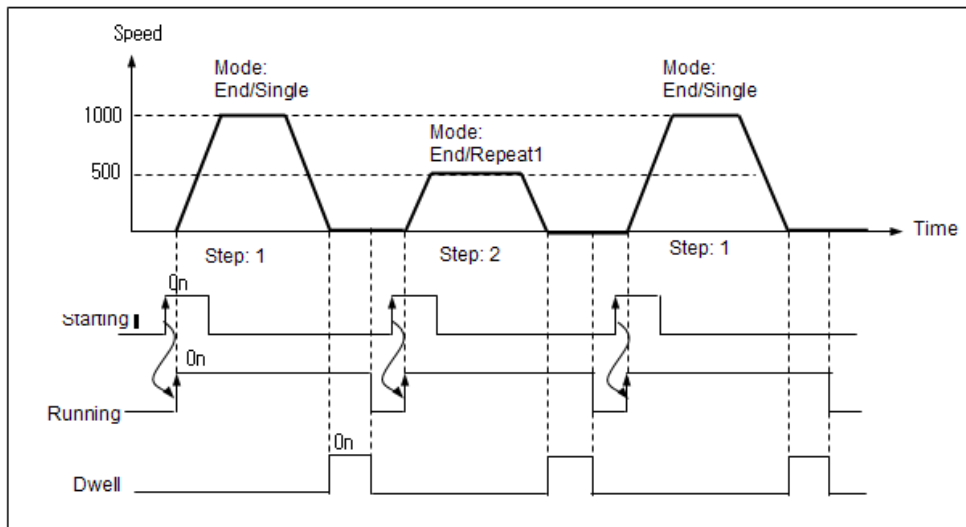

### Remark

- If the operation mode is set as single, set the operating step number in the IST at 0, then the step specified in the current step number (axis X: K426(%KW426), axis Y: K436(%KW436)) in area K for positioning.
- If the operation mode is set as Repeat and the Repeat step is set at 0, the step stops operating and the next step changes into 0.  
In this case, the operating step gets out of the range of 1~30 (1~80 for the compact standard/high-end type) and error code 512 comes out, so be careful of the repeating step setting when you set at the repeating operation.

### (c) Continued Operation

- Continued operation refers to the operation which carried out positioning to the target position by using the data of the corresponding operating step by the operation instruction and continues the next operating steps without any additional operation instructions with the positioning not completed after the dwell time.
- The next operating steps differ according to the current operating mode of the steps.
  - A) The operation mode of the current step is single: current operating step + 1
  - B) The operation mode of the current step is repetition: the step designated as Repeat in the current operation step
- If you use the continued operation pattern, you can conduct the pattern operation that sequentially carried out multiple operating steps with only one operation instruction.
- The continued operation can be explained with the operation data in the following table.

Step No.	Coordinates	Operation pattern	Control	Operation mode	Repeating step	Target position [Pulse]	M code	Acc./Dec. No.	Speed [pps/s]	Dwell time [ms]
1	Absolute	Keep	Position	Single	0	10,000	0	0	1,000	100
2	Absolute	Keep	Position	Single	0	20,000	0	0	500	100
3	Absolute	End	Position	Single	0	30,000	0	1	1,000	0
4	Absolute	End	Position	Repeat	1	40,000	0	1	500	0

- 1) Steps 1 and 2 are continued in the operation pattern and single in the operation mode, so they operate at 1,000pps to the pulse of absolute coordinates 10,000 and then operates step 2, the next step, without waiting for the next operation instruction when the dwell time passes. If the dwell time passes after step 2, step 3 is operated.
- 2) Step 3, of which the operation pattern is end, operates up to absolute coordinates 30,000, and then stops right away

## Chapter 3 Before Positioning

because the dwell time is 0, and the positioning completion bit turns on for a scan.

- 3) Since the operation mode of step 3 is single, the next step is No. 4.
- 4) Step 4 has been set as end/repeat 1, it operates up to absolute coordinates 40,000 when step 4 operates by the second operation instruction, and stops without dwell time, and the next step points at step 1 which has been designated as the Repeat step.
- 5) The operation pattern can be illustrated as follows.

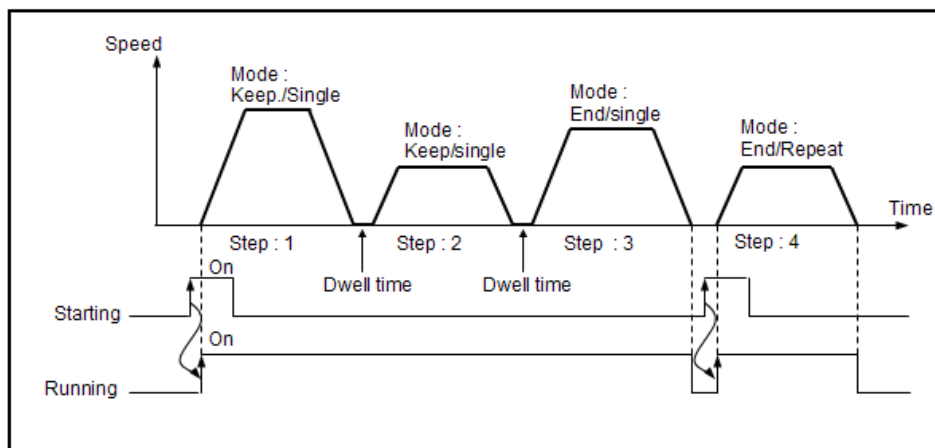

### (d) Incessant Operation

- Incessant operation refers to the operation that continues the steps set as continued operation by the operation instruction.
- The continued operation can be explained with the operation data in the following table.

Step No.	Coordinates	Operation pattern	Control	Operation mode	Repeating step	Target position [Pulse]	M code	Acc./Dec. No.	Speed [pls/s]	Dwell time [ms]
1	INC	Continuous	Position	Single	0	10,000	0	1	500	100
2	INC	End	Position	Repeat	1	20,000	0	1	1,000	0

- 1) Since the operation pattern of step 1 has been set as continued, it operates up to the incremental coordinates 10,000 pulse at 500pps by the first operation instruction, and changes the operation speed to 1,000pps without deceleration or stop and continues to operate step 2.
- 2) Because the operation pattern of step 2 is end, it moves to incremental coordinates 20,000 and the positioning ends after the dwell time.

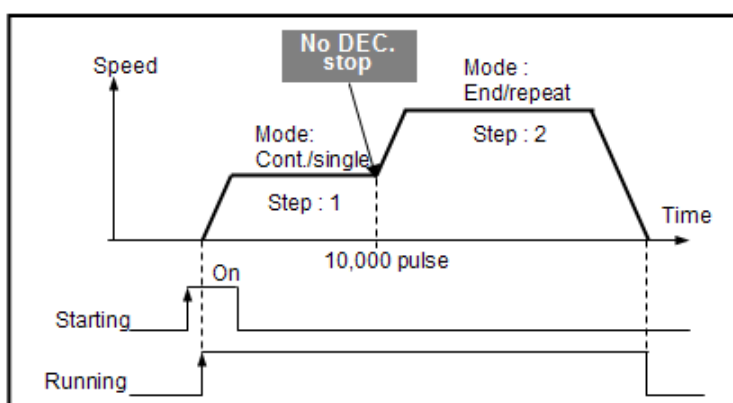

### Remark

- If the direction changes during the continued operation, error code 511 comes out and the operation stops. If the direction has to change, change "Continuous" into "End" or "Keep".



## (4) Repeat Step

- Sets the step to repeat when the operation mode is set as Repeat.
- The setting range is 1~30 (1~80 for the compact standard/high-end type).

## (5) Target Position

- Sets the movement of the operation of the step.
- The setting range is -2,147,483,648 ~ 2,147,483,647 (unit: Pulse).
- The target position set in operation data setting can be freely changed in the program by changing the value of area K for positioning.
- For the address of area K for positioning of each step number, see 2.2.

## (6) M Code

- M code is for checking the current operation step or carrying out the auxiliary work such as tool change, clamp, and drill rotation.
- In general, the output of M code divides into the 'With' mode, when M code is output with the step operating, and the 'After' mode when M code is output after the step operation is completed.  
For XGB built-in positioning, the standard type has only the After mode, and the advanced type has all modes.
- For example, if M code output mode is set as the After mode, the positioning of the step is completed and at the same time, the M code On signal (axis X: K4203, axis Y: K4303 ) is set and the M code number set in the M code item of the step operation data is output in the M code output device (axis X: K428, axis Y: K438).
- M code can be set differently for the operation steps of the positioning operation data. The setting range is 1 ~ 65,535. If you don't want to use M code function for the step, just set it at 0. If you don't want to use M code function for any step, set the M code output mode parameter as NONE.
- If there is the M code signal, you can reset it by using the M code Off instruction (MOF).
- If there is the M code signal, the operation differs depending on the current operation pattern.
  - (a) End: Stops with M code coming out. For operation of the next operation step, the M code should be reset and the operation instruction should be executed.
  - (b) Continued: Enters the Stand-by status for operation of the next step with M code coming out. For operation of the next operation step, if the M code is reset, the next operation step is operated without additional operation instructions.
  - (c) Incessant: Does not stop and operates the next operation step although M code comes out. In this case, M code Off instruction can be carried out even during operation.

- For example, the output timing of M code signals in case of After Mode can be illustrated as follows.

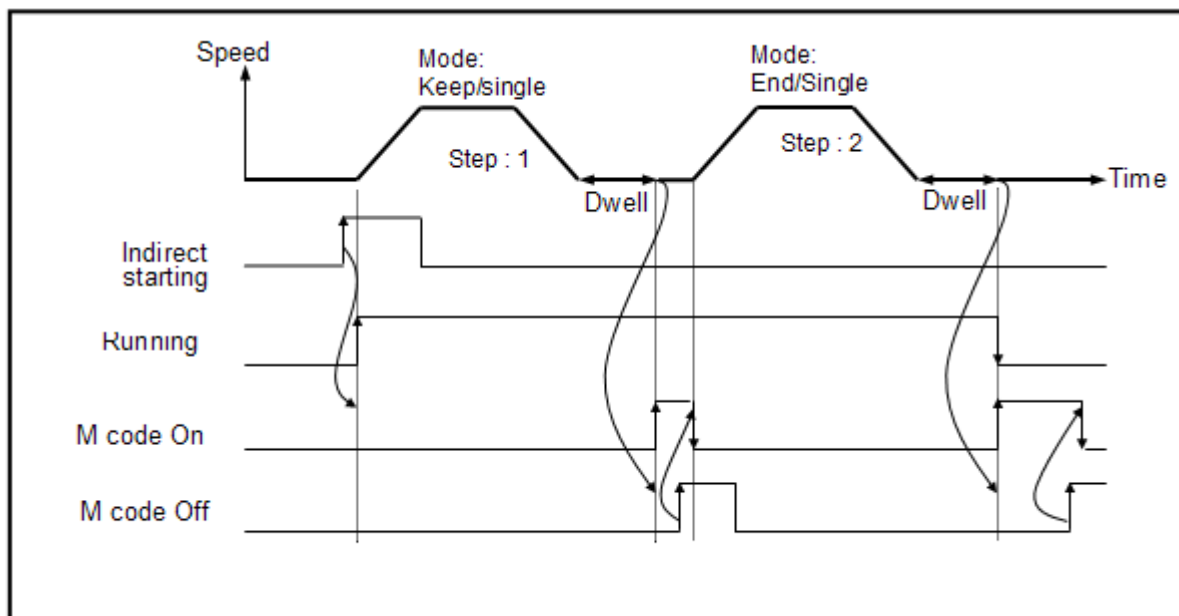
**Remark**

- With M code signal On, if you execute the next operation step number, error code 233 will come out and the operation will not happen. Therefore, for positioning of the next operation step number with M code signal "On," you must reset M code signal as M code Off instruction (MOF).

## (7) Acceleration/Deceleration Numbers

- Sets the Acc./Dec. numbers to be used in the step during the acceleration/deceleration time set in the basic positioning parameter.
- The setting range is 1~4.
- For details about the acceleration/deceleration time, see 3.2.3.

## (8) Operation Speed

- Set the target speed at which to operate in the step.
- The setting range is 1 ~ 100,000 pulse (unit:1pps).
- The operation speed should be set higher than or equal to the bias speed set in the basic positioning parameter, and lower than or equal to the speed limit.

## (9) Dwell Time

- The dwell time to be applied to the operation step.
- The dwell time refers to the time needed to maintain the precise stop of the servo motor in controlling the positioning by using the servo motor, and also the standby time given before the next positioning operation when one positioning operation is finished.
- Especially when the servo motor is used, it might not reach the target position or stay excessive even though the output of the positioning function has been stopped, so the dwell time is the data that set the standby time until the stable rest.
- The operation status of the axis of the XGB positioning function during the dwell time maintains "Operation," and if the dwell time passes, the operation status signaling bit (axis X: K4200(%KX6720), axis Y: K4300(%KX6880)) turns Off and the positioning completion signal turns On.

### 3.4 Positioning Status Monitoring and Area K for Input and Output

The XGB built-in positioning function controls positioning by using area K for positioning and the parameters. This Chapter describes area K for positioning. For the relations between the XGB built-in positioning parameters and area K, see 3.2.2. XGB built-in positioning area K divides into the bit flag, word, and double word flag. The flag in turn divides into the status monitoring flag area (for read only) and the flag for instruction and command (for read and write).

#### Status Monitoring and Flag for Positioning

This chapter describes the XGB built-in status monitoring flag for positioning (for read only).

The status monitoring flag divides into bit, word, and double word.

##### (1) Bit Area Flag

Variables	Device Area						Status
	Axis X			Axis Y			
	Word	Bit	Address	Word	Bit	Address	
In operation	K420	0	K4200	K430	0	K4300	0: stop, 1: operation
Error		1	K4201		1	K4301	0: no error, 1: error
Positioning completed		2	K4202		2	K4302	0: not completed, 1: completed
M code signal		3	K4203		3	K4303	0:M code Off, 1:M code On
Origin settled		4	K4204		4	K4304	0: origin not decided, 1: origin decided
No pulse output		5	K4205		5	K4305	0: output available, 1: no output
Stopped		6	K4206		6	K4306	0: not stopped, 1: stopped
Upper limit detected		8	K4208		8	K4308	0: undetected, 1: detected
Lower limit detected		9	K4209		9	K4309	0: undetected, 1: detected
Emergency stop		A	K420A		A	K430A	0: normal, 1: abnormally stopped
Normal/backward rotation		B	K420B		B	K430B	0: normal direction, 1: backward direction
Operation (acceleration)		C	K420C		C	K430C	0: not accelerated, 1: accelerated
Operation(constant speed)		D	K420D		D	K430D	0: not constant speed, 1: constant speed
Operation (deceleration)		E	K420E		E	K430E	0: not decelerated, 1: decelerated
Operation (dwell)		F	K420F		F	K430F	0: not during dwell, 1: during dwell
Operation (positioning)	K421	0	K4210	K431	0	K4310	0: position not controlled 1: position controlled
Operation (speed control)		1	K4211		1	K4311	0: speed not controlled 1: speed controlled
Operation control (straight interpolation)		2	K4212		2	K4312	0: interpolation not controlled 1: interpolation controlled
Return to origin		5	K4215		5	K4315	0: not returning to origin 1: returning to origin
Position synchronization		6	K4216		6	K4316	0: position not synchronized 1: position synchronized
Speed synchronization		7	K4217		7	K4317	0: speed not synchronized 1: speed synchronized
Jog low speed		8	K4218		8	K4318	0: jog not at low speed 1: jog at low speed
Jog high speed		9	K4219		9	K4319	0: jog not at high speed 1: jog at high speed
Inching operation		A	K421A		A	K431A	0: not during inching operation 1: during inching operation

## (2) Status Monitoring Data Area

Variables	Device Area				Status
	Axis X		Axis X		
	Address	Properties	Address	Properties	
Current position	K422	Double word	K432	Double word	Shows current position
Current speed	K424	Double word	K434	Double word	Shows current speed
Step No.	K426	Double word	K436	Word	Shows current operation step
Error code	K427	Word	K437	Word	Shows error code in case of an error
M code No.	K428	Word	K438	Word	Shows M code number when M code is on

### Flag for Positioning Instruction and Command

The flag for positioning instruction and command divides as follows. You can easily conduct positioning operation without positioning instruction using the flag. If you change the flag for instruction of area K, the scan ends and applies in the next scan.

## (1) Bit Area Flag

Variables	Device Area						Status
	Axis X			Axis Y			
	Word	Bit	Address	Word	Bit	Address	
Start signal	K429	0	K4290	K439	0	K4390	Indirect start at rising edge
Normal direction jog		1	K4291		1	K4391	0: stop jog, 1: normal direction jog operation
Backward direction jog		2	K4292		2	K4392	0: stop jog,, 1: normal direction jog operation
Jog high/low speed		3	K4293		3	K4393	0: jog low speed, 1: jog high speed
M code output mode	K468	1	K4681	K508	1	K5081	0: NONE, 1: WITH, 2: AFTER
		2	K4682		2	K5082	
Upper/lower limit detection of SW allowed during constant speed operation		4	K4684		4	K5084	0: detection not allowed, 1: detection allowed
Return-to-origin method	K478	0,1	K4780~1	K518	1	K5180~1	0: approximate origin/origin(OFF) 1: approximate origin/origin (On) 2: approximate origin
Return-to-origin direction		2	K4782		2	K5182	0: normal direction, 1: backward direction
Use for positioning	K487	0	K4870	K527	0	K5270	0: use, 1: no use
Pulse output level		1	K4871		1	K5271	0: low Active, 1: high Active
Use of upper/lower limit		2	K4872		2	K5272	0: no use, 1: use
Pulse output mode		3	K4873		3	K5273	0: CW/CCW, 1: PLS/DIR

## (a) Starting Signals

- 1) The starting signals conducts positioning operation according to the current operation step number (axis X: K426, axis Y: K436) without setting the step number unlike indirect or direct starting.
- 2) Since the current operation step area is for read only, if you want to change the operation step number, you need to use the starting step number change instruction (SNS, APM\_SNS).
- 3) The following program is an example of the program that indirectly starts with the operation data displayed in the current step number (K426) on axis X by setting the starting signal whenever the external input starting switch (P000F) turns On.

P000F	K04200	K04201	K04290
	/	/	(S)
Starting switch	XAxis BUSY	XAxis Error	XAxis Start
P000F			K04290
/			(R)
Starting switch			XAxis Start
Device	Description	Device	Description
P000F	Axis X starting external switch	K4201	Axis X error
K4200	Axis X signal during operation	K4290	Axis X starting instruction flag

- The program above is an example of the program that indirectly starts with the operation data of the current step number (K426 word) on axis X by setting the starting signal whenever the external input starting switch (P000F) turns On.
- When the starting switch turns On, the starting commanding flag (K4290) is set and axis X starts, and when the starting switch turns Off, the starting contact point is reset.
- Note that the set coil is used for axis X starting commanding flag (K4290) instead of ordinary coil output. For example, if a toggle switch is used for the starting switch, and if the starting commanding flag (K4290) is not set but ordinary coil output is used, there might be the problem that it is automatically restarted by the bit Off during operation when positioning is completed. To avoid this, use a push button switch for the external input switch, and use a set coil and reset coil according to the On/Off of the input switch for the starting commanding flag.

## (b) Jog Operation

- 1) The following program is an example of the program that carries out the jog operation of axis X by turning on/off the flag for commanding the normal/backward direction jog according to the external input signal.

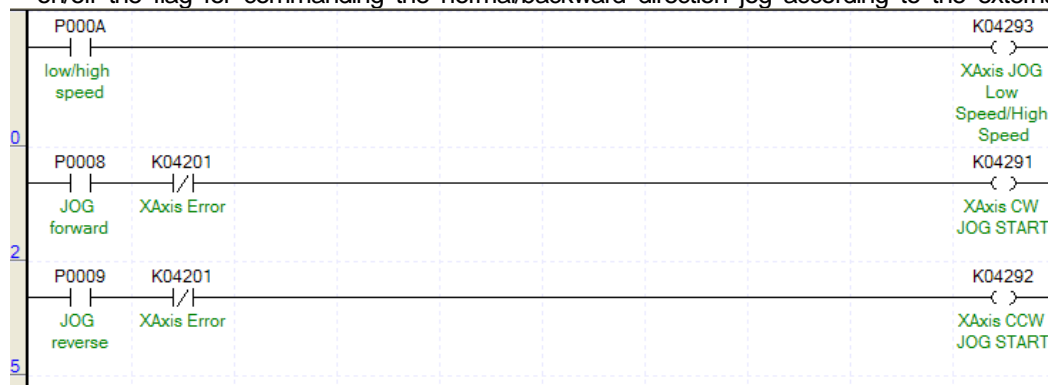

Device	Description	Device	Description
P0008	External input of normal direction jog	K4201	Flag displaying axis X error
P0009	External input of backward direction jog	K4291	Flag commanding normal direction jog of axis X
P000A	External input of jog low speed/high speed	K4292	Flag commanding backward direction jog of axis X
K4200	Signal of axis X during operation	K4293	Flag commanding jog low/high speed of axis X

- The program above is an example of the program that carries out the jog operation in the corresponding direction while the external input normal direction jog switch (P0008) or backward direction jog switch (P0009) is On.
- Then the operation speed is jog high speed if the jog low/high speed external input (P000A) is On, and high low if Off, and can be changed during jog operation, too.
- As the start and stop of jog operation is done by the level of the input signals, if the input signal (P0008, P0009) is On, it operates, and if Off, it carries out jog stop.
- If both jog normal direction operation and backward direction operation are On, there is no error code in XGB built-in positioning, but it stops if it is currently in operation.

**Remark**

- If you do jog operation by adding the signal (K4200(%KX6720), K4300(%KX6880)) during operation as the normally closed contact point (contact point B) for the jog operation input condition, it alternates starting and stopping according to the On/Off of the signal during operation.

## (2) Data Area for Positioning Setting

Variables	Device Area				Status
	Axis X		Axis Y		
	Address	Properties	Address	Properties	
Bias speed	K0450	Double word	K0490	Double word	Sets bias speed.
Speed limit	K0452	Double word	K0492	Double word	Sets maximum speed limit.
Acceleration time 1	K0454	Word	K0494	Word	Sets acceleration time 1.
Deceleration time 1	K0455	Word	K0495	Word	Sets deceleration time 1.
Acceleration time 2	K0456	Word	K0496	Word	Sets acceleration time 2.
Deceleration time 2	K0457	Word	K0497	Word	Sets deceleration time 2.
Acceleration time 3	K0458	Word	K0498	Word	Sets acceleration time 3.
Deceleration time 3	K0459	Word	K0499	Word	Sets deceleration time 3.
Acceleration time 4	K0460	Word	K0500	Word	Sets acceleration time 4.
Deceleration time 4	K0461	Word	K0501	Word	Sets deceleration time 1
Upper limit of software	K0462	Double word	K0502	Double word	Sets upper limit value of software.
Lower limit of software	K0464	Double word	K0504	Double word	Sets lower limit value of software.
Backlash correction	K0466	Word	K0506	Word	Sets backlash correction value.
Origin address	K0469	Double word	K0509	Double word	Sets origin address for origin return.
High speed of origin return	K0471	Double word	K0511	Double word	Sets high speed for origin return.
Low speed of origin return	K0473	Double word	K0513	Double word	Sets low speed for origin return.
Acceleration time for origin return	K0475	Word	K0515	Word	Sets acceleration time for origin return
Deceleration time for origin return	K0476	Word	K0516	Word	Sets deceleration time for origin return
Dwell time for origin return	K0477	Word	K0517	Word	Sets dwell time for origin return
Jog high speed	K0479	Double word	K0519	Double word	Sets high speed for jog operation.
Jog low speed	K0481	Double word	K0521	Double word	Sets low speed for jog operation
Jog acceleration time	K0483	Word	K0523	Word	Sets acceleration time for jog operation
Jog deceleration time	K0484	Word	K0524	Word	Sets deceleration time for jog operation
Inching speed	K0485	Word	K0525	Word	Sets operation speed for inching operation.

## (3) Status Monitoring and Commanding Flag by Operation Step

Variables	Device area			Status
	Axis X	Axis Y	properties	
	Address	Address		
Step 01 target position	K0530	K0830	Double word	
Step 01 operation speed	K0534	K0834	Double word	
Step 01 dwell time	K0536	K0836	Word	
Step 01 M code number	K0537	K0837	Word	
Step 01 operation method	K05380	K08380	Bit	
Step 01 control method	K05381	K08381	Bit	
Step 01 operation pattern (Low)	K05382	K08382	Bit	
Step 01 operation pattern (High)	K05383	K08383	Bit	
Step 01 coordinates	K05384	K08384	Bit	
Step 01 acc./dec. number (Low)	K05386	K08386	Bit	
Step 01 acc./dec. number (High)	K05387	K08387	Bit	
Step 01 coordinates	K0539	K0839	Word	

- The table above shows the area K for positioning of the operation step #1. You can change the operation data without setting the parameters by changing the value of the corresponding area K.
- If you want to permanently preserve the operation data of the changed area K, apply the data of current area K to the built-in parameter area by using the applied instruction (WRT instruction, APM\_WRT instruction).

**Remark**

- Note that area K for positioning is initialized if you cut the power and re-supply power or if you change the operation mode without executing the WRT instruction after changing the value of area K.
- The variable of area K for each step can be used more conveniently by using the variable registration function of XG5000. For the positioning monitor registration, see the manual of XG5000.





## Chapter 4 Positioning Check

This Chapter describes how to test the operation test to check whether the positioning function is well performed before the XGB positioning function is used.

### 4.1 The Sequence of Positioning Check

This is for checking whether the XGB positioning operation is normally performed by carrying out normal and reverse direction jog operation. The sequence is as follows.

#### (1) Power Off

- Distribution is needed to check the XGB positioning operation. Before distribution, turn off XGB.
- Be sure to check whether the PWR LED of XGB is off before moving on to the next step.

#### (2) Input Signal Distribution

- Distribute the input signals needed to check the operation as follows.
- Do not connect the output signal line to the motor driver. If there is a problem with the PLC hardware, connecting to the motor driver might lead to malfunction or damage to the equipment.

Input Signal	Contact Point Type	Contact Point No.		Remark
Jog normal direction switch	Contact point normally open (A)	Axis X	P0010	Contact point randomly selected
		Axis Y	P0011	Contact point randomly selected
Axis X		P0012	Contact point randomly selected	
Axis Y		P0013	Contact point randomly selected	
Jog reverse direction switch				

#### (3) Making the Program for Operation Check

- Make the program for checking the operation by using XG5000. For the details and making of the program, see '4.2 Making of the Program for Operation Check.'

#### (4) Power Supply and Program Writing

- If you have finished making the program, supply power to XGB PLC, and use XGB as the parameter and the program.

#### (5) Input Contact Point Operation Check

- Before switching the operation mode of the PLC to RUN, check the normal operation of the input contact point as follows.

Input Signal	Contact No.		Operation Check
Jog normal direction	Axis X	P0010	• Check whether the LED of the contact point turns on while the switch is ON and the value of the contact point changes into 1 in the device monitor of XG5000.
	Axis Y	P0011	
Jog reverse direction	Axis X	P0012	
	Axis Y	P0013	

- If the device doesn't work as described in the table above, there might be a problem with the LED or the input hardware, so contact the customer center.

#### (6) Operation Check through Jog Operation

- Check the operation of XGB positioning doing jog operation in the following sequence.
- This manual describes the axis X operation check when the pulse output mode is PLS/DIR mode and the pulse output

level is set as Low Active. Check the operation of axis Y. in the same manner.

(a) Check of Normal Direction Rotation of Jog

- Turn on the normal direction switch(P0010) of axis X, with the reverse direction switch of the jog set at Off.
- Check whether the XGB positioning function normally generates jog normal direction output.

1) Check of the output LED

- P0020 : flashes quickly
- P0022 : stays ON

2) Check of area K

- Check whether the current position address is increasing by checking the current position address area (axis X: K422 double word) with XG5000.

(b) Check of Normal Direction Stop of Jog

- Turn Off the jog normal direction switch (P0010) during jog normal direction operation, and check whether the output LED (P0020, P0022) is Off, the current position address area (axis X: K422, double word) with XG5000, and whether the current position address has stopped increasing.

(c) Check of Reverse Direction Rotation of Jog

- Turn on the axis X jog reverse direction switch (P0012, ), with the normal direction switch of the jog Off.
- Check whether the XGB positioning function is generating jog reverse direction output normally.

1) Output LED Check

- P0020 : flashes quickly
- P0022 : stays OFF

2) Check of area K

- Check whether the current position address is decreasing by checking the current position address area (axis X: K422, double word) with XG5000

(d) Check of Reverse Direction Stop of Jog

- Turn Off the jog reverse direction switch (P0012, ) during jog reverse direction operation, and check whether the output LED (P0020, , P0022, ) is Off, the current position address area (axis X: K422, double word) with XG5000, and whether the current position address has stopped decreasing

(e) For compact standard type, there is not actual output P00040/P00044 and they are indicated by LED.

(7) Finish of Positioning Check

- When you have finished checking whether the jog normal and reverse operation is normally operating through the process above, end the check, make the positioning operation program to be actually used and conduct the positioning operation.

## 4.2 Making of Operation Check Program

The program for operation check used in this manual should be made as follows.

The positioning parameters should be set as follows. For setting the positioning parameters, see 3.2.

### (1) Positioning Basic Parameters

Items	Range	Initial Values	Data Size
Positioning	0 : not used, 1 : used	0	Bit
Pulse output level	0 : Low Active, 1 : High Active	0	Bit
Pulse output mode	0 : CW/CC, 1 : PLS/DIR	1	Bit
M code output mode	0 : NONE, 1 : WITH, 2 : AFTER	0	2 Bit
Bias speed	1 ~ 100,000[pulse/sec.]	1	Double word
Speed limit	1 ~ 100,000[pulse/sec.]	100,000	Double word
Acceleration time 1	0 ~ 10,000[unit: ms]	500	Word
Deceleration time 1	0 ~ 10,000[unit: ms]	500	Word
Acceleration time 2	0 ~ 10,000[unit: ms]	1,000	Word
Deceleration time 2	0 ~ 10,000[unit: ms]	1,000	Word
Acceleration time 3	0 ~ 10,000[unit: ms]	1,500	Word
Deceleration time 3	0 ~ 10,000[unit: ms]	1,500	Word
Acceleration time 4	0 ~ 10,000[unit: ms]	2,000	Word
Deceleration time 4	0 ~ 10,000[unit: ms]	2,000	Word
S/W upper limit	-2,147,483,648 ~ 2,147,483,647 [pulse]	2,147,483,647	Double word
S/W lower limit	-2,147,483,648 ~ 2,147,483,647 [pulse]	-2,147,483,648	Double word
Backlash correction	0 ~ 65,535[pulse]	0	Word
SW upper and lower limit during constant speed operation	0 : not detected, 1 : detected	0	Bit
Use of upper and lower limit	0 : not used, 1 : used	1	Bit

### (2) Home return/Manual Operation Parameter

Items	Range	Initial Values	Data Size
Home return method	0 ~2	0	Bit
Home return direction	0 : normal direction, 1 : reverse direction	1	Bit
Origin address	-2,147,483,648~2,147,483,647[pulse]	0	Double word
Home return high speed	1 ~ 100,000[pulse/sec.]	5,000	Double word
Home return low speed	1 ~ 100,000[pulse/sec.]	500	Double word
Home return acceleration time	0 ~ 10,000[unit: ms]	1,000	Word
Home return deceleration time	0 ~ 10,000[unit: ms]	1,000	Word
Dwell time	0 ~ 50,000[unit: ms]	0	Word
JOG high speed	1 ~ 100,000[pulse/sec.]	5,000	Double word
JOG low speed	1 ~ 100,000[pulse/sec.]	1,000	Double word
JOG acceleration time	0 ~ 10,000[unit: ms]	1,000	Word
JOG deceleration time	0 ~ 10,000[unit: ms]	1,000	Word
Inching speed	1 ~ 65,535[pulse/sec.]	100	Word

## (3) Example of the Program

The following is an example of the program for positioning check.

0	P0011 YAxis JOG CW	K04201 XAxis Error	K04870 XAxis Position Enable	K04291 XAxis CW JOG START
4	P0011 YAxis JOG CW	K04301 YAxis Error	K05270 YAxis Position Enable	K04391 YAxis CW JOG START
8	P0012 XAxis JOG CCW	K04201 XAxis Error	K04870 XAxis Position Enable	K04291 XAxis CW JOG START
12	P0013 YAxis JOG CCW	K04301 YAxis Error	K05270 YAxis Position Enable	K04391 YAxis CW JOG START
16				END

## Chapter 5 Positioning Instructions

This chapter describes the definitions, functions, use of the positioning instructions used in XGB positioning functions and the program examples.

### 5.1 Positioning Instruction List

The positioning instructions used for XGB positioning are as follows.

Instructions	Description	Conditions	Remark
ORG	Start return to the origin	Slot, instruction axis	5.2.1
FLT	Set floating origin	Slot, instruction axis	5.2.2
DST	Direct starting	Slot, instruction axis, position, speed, dwell time, M code, control word	5.2.3
IST	Indirect starting	Slot, instruction axis, step number	5.2.4
LIN	Linear interpolation starting	Slot, instruction axis, step number, axis information	5.2.5
SST	Simultaneous starting	Slot, instruction axis, axis X step, axis Y step, axis Z step, axis information	5.2.6
VTP	Speed/position switching	Slot, instruction axis	5.2.7
PTV	Position/speed switching	Slot, instruction axis	5.2.8
STP	Stop	Slot, instruction axis, deceleration time	5.2.9
SSP	Position synchronization	Slot, instruction axis, step number, main axis position, main axis setting	5.2.10
SSS	Speed synchronization	Slot, instruction axis, synchronization rate, delay time	5.2.11
POR	Position override	Slot, instruction axis, position	5.2.12
SOR	Speed override	Slot, instruction axis, speed	5.2.13
PSO	Positioning speed override	Slot, instruction axis, position, speed	5.2.14
INCH	Inching starting	Slot, instruction axis, inching amount	5.2.15
SNS	Change starting step number	Slot, instruction axis, step number	5.2.16
MOF	Cancel M code	Slot, instruction axis	5.2.17
PRS	Preset current position	Slot, instruction axis, position	5.2.18
EMG	Emergency stop	Slot, instruction axis	5.2.19
CLR	Reset error, cancel output inhibition	Slot, instruction axis, inhibit/allow pulse output	5.2.20
WRT	Save parameter/operation data	Slot, instruction axis, select the storage area	5.2.21
PWM	Pulse width modulation	Slot, instruction axis, output cycle, off duty rate	5.2.22

#### Remark

- XGB positioning instructions are activated at the rising edge. That is, when the execution contact point is On, it carried out the instruction only once. (PWM instruction is activated at the "On" level)

## 5.2 Details of Positioning Instructions

### 5.2.1 Origin Return Instructions

- Origin return is used to check the origin of the machine when power is supplied to the machine in general. If the origin return instruction is given, it is executed depending on the setting of the origin return parameter. (for setting of the origin return parameter, refer to 3.2.4.)

Type	Items	Description	Remark
origin return parameter	origin return method	Set origin return method	
	origin return direction	Starting direction during origin return operation	
	Origin address	origin address in detecting origin	
	origin return speed	high/low speed during origin return operation	
	origin return dec./acc. time	dec./acc. time during origin return operation	
	origin return deceleration time	Set deceleration time during origin return operation	
	DWELL time	Time it takes to remove remaining pulse of the deviation counter right after origin return is finished	

- In general, the origin return divides into two ways, one of which is using the DOG and the other is not using it. In XGB positioning function, the following three ways can be used that use the DOG. (for details of the origin return method, refer to 3.1.9.)

Origin return method	Necessary input signals	Remark
Detect origin after DOG turns Off (0: DOG/origin (OFF))	DOG signal, origin signal	( ) is what is displayed in the positioning origin/manual parameter.
When DOG is On, detect the origin after deceleration . (1: DOG/origin (On))	DOG signal, origin signal	
Detect the origin by DOG (2: DOG)	DOG signal	

- The following diagram is an example of origin detection by DOG among the three ways of origin return.

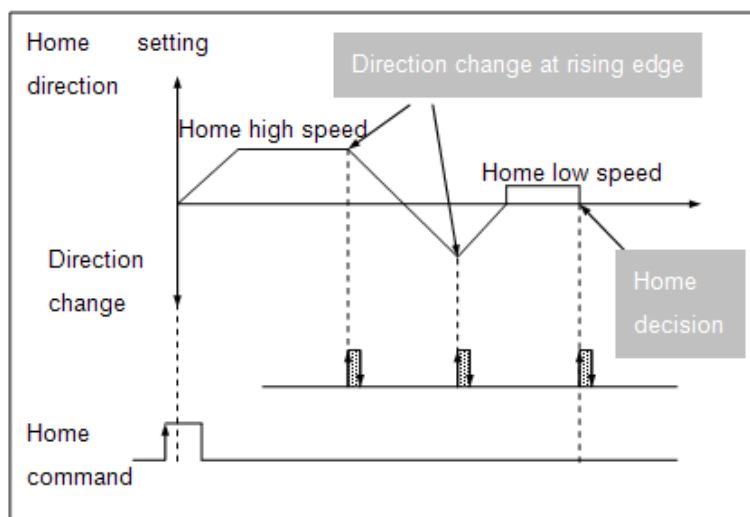

## (1) Origin return Instruction (ORG)

Instruction	Available areas														Step	Flag		
	PMK	F	L	T	C	S	Z	D.x	R.x	constant	U	N	D	R		Error (F110)	Zero (F111)	Carry (F112)
ORG	sl	-	-	-	-	-	-	-	-	-	○	-	-	-	4~7	○	-	-
	ax	○	-	○	-	-	-	○	-	-	○	-	-	○		-	-	-

## [Area setting]

Operand	Description	Setting range	Data size
sl	Slot number where positioning modules are mounted	XGB is fixed at 0.	WORD
ax	The axis to give instructions	0(axis X) or 1(axis Y)	WORD

## [Flag Set]

Flag	Description	Device number
Error	If the value of ax gets out of the range	F110

## (a) Function

- This instruction is for carrying out the origin return of the XGB built-in positioning function.
- It gives the origin return instruction to the axis designated as the ax of positioning built in XGB at the rising edge of the input condition.
- When origin return is completed, the origin setting bit (axis X:K4204,axis Y:K4304) turns On and the current address is preset at the address value set in the origin return parameter.

## (b) Error

- If the value designated as ax (instruction axis) is other than 0 and 1, the error flag (F110) is set and the instruction is not executed.
- This is an error of instruction execution, so the error flag (axis X:K4201,axis Y: K4301) of area K for positioning does not turn On.

## (2) Related Device Alarm

- The parameters and area K devices related to ORG instructions are as follows.

Item	Parameter Setting range	Area K			Data size
		axis X	axis Y	Properties	
origin return method	0 : DOG/Home(Off) 1 : DOG/Home(On) 2 : DOG	K4780 K4781	K5180 K5181	Read/write	2 bit
origin return direction	0 : CW, 1 : CCW	K4782	K5182	Read/write	Double word
origin address	-2,147,483,648 ~ 2,147,483,647[pulse]	K469	K509	Read/write	Double word
origin return high speed	1 ~ 100,000[pps]	K471	K511	Read/write	Double word
origin return low speed	1 ~ 100,000[pps]	K473	K513	Read/write	Double word
origin return acceleration time	0 ~ 10,000[ms]	K475	K515	Read/write	Word
origin return deceleration time	0 ~ 10,000[ms]	K476	K516	Read/write	Word
Dwell time	0 ~ 50,000[ms]	K477	K517	Read/write	Word



(3) Examples of Instructions

- The origin return instructions are described as follows with the examples of the parameters and programs.
- The examples of the ORG instructions are described on the basis of axis X.

(a) Parameter Setting

Parameter				
Item	Value			
origin return method	1: DOG /origin(On)	Home Parameter	Home Method	1: DOG/HOME(ON)
origin return direction	1: reverse direction		Home Direction	1: CCW
Origin address	0		Home Address	0 pls
origin return high speed	50,000[pps]		Home High Speed	5000 pls/s
origin return low speed	500[pps]		Home Low Speed	500 pls/s
origin return acceleration time	100[ms]		Homing ACC Time	100 ms
origin return deceleration time	100[ms]		Homing DEC Time	100 ms
Dwell time	100[ms]		DWELL Time	100 ms

(b) Examples of the Program

Rung	Step	Instruction	OP 1	OP 1	OP 2
0	0	LOADP	M0000	Home Retrun Run	
	2	AND NOT	K04200	XAxis BUSY	
	3	AND NOT	K04201	XAxis Error	
	4	ORG	0		0
1	7	END			

(c) Devices Used

Device	Description
M0000	Starting signal of axis X origin return
K4200	Signal during axis X operation
K4201	axis X error

(d) Program Operation

- The ORG instruction is executed when there is the rising edge of M0000 which was used as the starting signal of the axis X origin return.  
(It doesn't work if axis X is operating or in error)
  - 1) If the origin return instruction (ORG instruction) is executed, it is decelerated in the reverse direction as set in the origin return parameter and operates at origin return high speed (50,000pps).
  - 2) If there is the rising edge of the DOG signal during origin return high speed operation, it is decelerated and operates at origin return low speed (500pps). The deceleration time is 100ms, set in the parameter.
  - 3) If the origin signal is input, which is the external input signal, after switch to the origin return low speed, the output immediately stops, and the origin determining status flag (K4204 bit) turns On after the dwell time (100ms).  
(There may be a delay as long as 'dwell time + 1 scan time' until the origin determining status flag (K4204 bit) turns On after the output stops.)

- 4) Then the current address is preset at 0, which is the origin address set in the parameter.

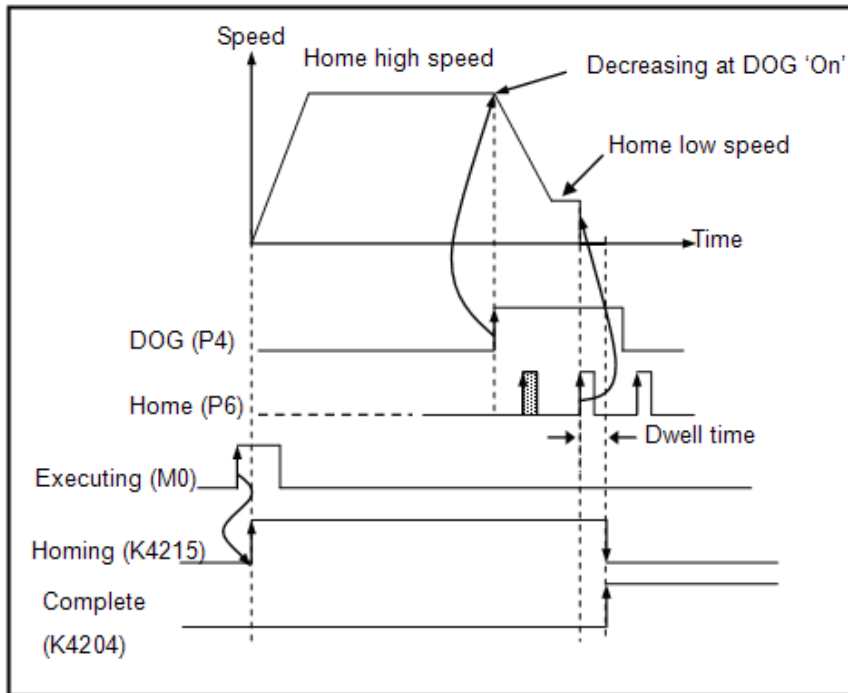

#### Remark

- The DOG signal and origin signal are respectively fixed as the following contact points.

	Standard		Compact standard/high-end type	
	DOG	origin	DOG	origin
axis X	P0004	P0005	P000C	P000D
axis Y	P0006	P0007	P000E	P000F

- If the contact points of the DOG and the origin input are used together as the external preset input of the high speed counter, or together as the starting signal of the external contact point task, the origin detection might be inaccurate.
- The current position address does not change during origin return.

## 5.2.2 Floating Origin Setting Instruction

- Floating origin setting refers to setting the current position as the origin by force with the instruction without carrying out the actually mechanical origin return.

### (1) Floating origin Setting Instruction (FLT)

Instruction	Areas available														Step	Flag			
	PMK	F	L	T	C	S	Z	D.x	R.x	constant	U	N	D	R		Error (F110)	Zero (F111)	Carry (F112)	
FLT	sl	-	-	-	-	-	-	-	-	-	○	-	-	-	-	4~7	○	-	-
	ax	○	-	○	-	-	-	○	-	-	○	-	-	○	-				

#### [Area Setting]

Operand	Description	Setting range	Data size
sl	Slot number where positioning module is mounted	XGB is fixed at 0	WORD
ax	Axis to give instruction	0(axis X) or 1(axis Y)	WORD

#### [Flag Set]

Flag	Description	Device number
Error	If the value of ax gets out of the range	F110

#### (a) Function

- This instruction is for setting the floating origin to the XGB built-in positioning.
- The instruction of setting the floating origin is given to the axis designated as ax of XGB positioning at the rising edge of the input condition.
- If the instruction is carried out, the current position address becomes 0, and the origin determining bit (axis X: K4204,axis Y:K4304) turns On.

#### (b) Error

- If the value designated as ax (instruction axis) is other than 0 and 1, the error flag (F110) is set and the instruction is not executed

#### Remark

- Floating origin setting presets the current position at 0 and only fixes the origin, so you need to note the following when you use the instruction of setting the floating origin.
  - Check whether there is an error before carrying out the floating origin setting instruction. If there is an error, remove the cause of the error, reset the error (CLR instruction) and terminate the output inhibition.
  - Now set the floating origin, change the step number to operate into the starting step change instruction (SNS), and then get it started.

## (2) Example of Use of the Instruction

- The floating origin setting instruction is described with the example of the following program.
- The example of use of the FLT instruction is described on the basis of axis X.

## (a) Example of the Program

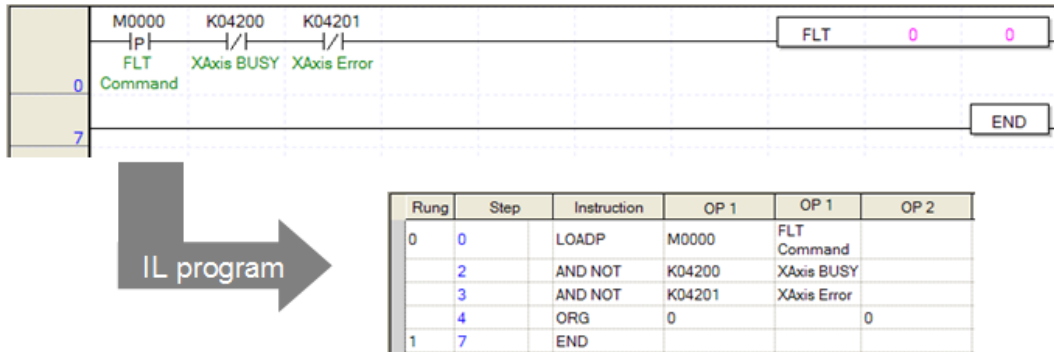

## (b) Device Used

Device	Description
M0000	axis X floating origin instruction signal
K4200	Signal during axis X operation
K4201	axis X error

## (c) Operation of the Program

- The FLT instruction is executed when there is the rising edge of M0000, which was used as axis X floating origin instruction signal.  
(Not if axis X is operating or in error)
- If the FLT instruction is executed, the origin is fixed right away at the current position differently from the origin return, the origin determining signal (axis X:K4204) turns On, and the current address is preset at 0.

### 5.2.3 Direct Starting Instruction

- Direct starting refers to designating the operation data of the target position and speed from the positioning instruction (DST instruction) for operation without using the setting of the step set in the positioning operation data.

#### (1) Direct Starting Instruction (DST)

Instruction	Areas available														Step	Flag			
	PMK	F	L	T	C	S	Z	D.x	R.x	constant	U	N	D	R		Error (F110)	Zero (F111)	Carry (F112)	
DST	sl	-	-	-	-	-	-	-	-	-	○	-	-	-	-	4~7	○	-	-
	ax	○	-	○	-	-	-	○	-	-	○	-	-	○	-				
	n1	○	-	○	-	-	-	○	-	-	○	-	-	○	-				
	n2	○	-	○	-	-	-	○	-	-	○	-	-	○	-				
	n3	○	-	○	-	-	-	○	-	-	○	-	-	○	-				
	n4	○	-	○	-	-	-	○	-	-	○	-	-	○	-				
	n5	○	-	○	-	-	-	○	-	-	○	-	-	○	-				

#### [Area Setting]

Operand	Description	Setting range	Data size
sl	Slot No. of positioning module	XGB is fixed at 0	WORD
ax	Axis to give instruction	0 (axis X) or 1 (axis Y)	WORD
n1	Target position	-2,147,483,648~2,147,483,647[Pulse]	DINT
n2	Target speed	1~100,000[pps]	DWORD
n3	dwel time	0~50,000[ms]	WORD
n4	M code number	M code (0~65,535)	WORD
n5	Control word	See '(a) function'	WORD

#### [Flag Set]

Flag	Description	Device number
Error	If the value of ax gets out of the range	F110

#### (a) Function

- This instruction is for directly ordering the start to XGB built-in positioning.
- This instruction carries out direct starting of the axis designated as ax of XGB positioning at the rising edge of input condition.
- If the instruction is executed, positioning operation is started by using the target position set in n1, the target speed set in n2, the dwell time set in n3, and the M code number set in n4 instead of the operation data set in the step number (axis X:K426, axis Y:K436 word) of area K.
- The absolute/Incremental coordinates, position/speed control and acceleration/deceleration pattern number are fixed by the setting of each bit of the control word set as n5.

Bit number	F	E	D	C	B	A	9	8	7	6	5	4	3	2	1	0
Setting item	Not used									Acc./dec. time		coordinates setting		Not used		control method
Setting range	-									0: 1, 1:2 2:3, 3:4		0: absolute 1: incremental		-		0: position 1: speed

- The instruction only sets the item of the operation data, and the basic parameter items related to the operation such as the bias speed and speed limit are fixed in the positioning basic parameters.
- If you use the DST instruction, the operation pattern is fixed as End operation, and the operation method is fixed as

## Chapter 5 Positioning Instructions

the single operation. But if continued operation or repeated operation is needed, use indirect starting (IST instruction).

### (b) Error

- If the value designated as ax (instruction axis) is other than 0 and 1, the error flag (F110) is set and the instruction is not executed.
- This case if an error of execution of the instruction, so the error of positioning area K flag (axis X:K4201, axis Y: K4301) does not turn On.

### (2) Example of Use of the Instruction

- Direct starting instruction is described with the example of the following program.
- The example of use of the DST instruction is described on the basis of axis X.

#### (a) Example of the Program

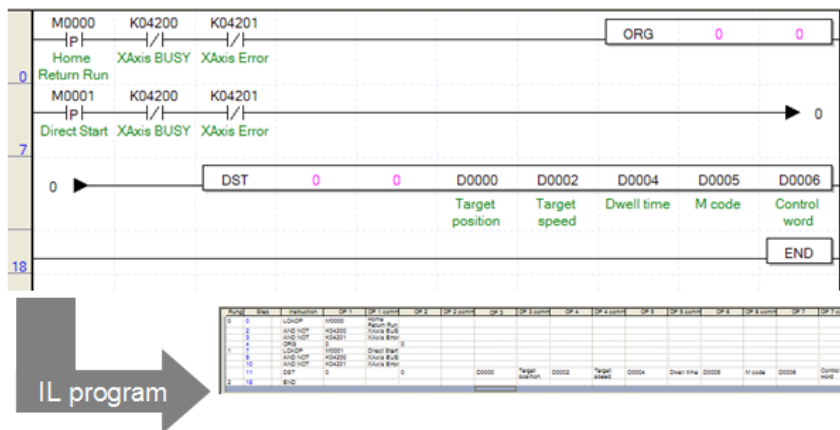

#### (b) Device Used

Device	Description	Data size	Example of setting
M0000	axis X origin return instruction signal	BIT	-
M0001	axis X direct starting instruction signal	BIT	-
K4200	signal during axis X operation	BIT	-
K4201	axis X error	BIT	-
D0000	Target position	DINT	100,000
D0002	Target speed	DWORD	30,000
D0004	Dwell time	WORD	100
D0005	M code number	WORD	123
D0006	Control word	WORD	H'20 <sup>*</sup>

<sup>\*</sup> H'20 : Bit5-6 : 1 (No.2 acceleration/deceleration pattern), Bit 4 : 0 (absolute coordinates),

Bit0 : 0(position control)

## (c) Operation of the Program

- If there is the rising edge of M0001 used as the direct starting instruction signal of axis X, the DST instruction is executed.  
(Not if axis X is operating or in error.)
  - If the origin is not fixed when the DST is started, error code 224 will appear and operation will not occur. In such a case, turn on M0000, execute the ORG instruction and thereby carry out the origin return, and start the DST instruction.
- 1) If the DST instruction is executed, the positioning operation gets started as set in the operand as follows.
    - Since sl and ax are 0, built-in positioning axis X is started.
    - The target position will be 100,000 pulse set as double word in D0002.
    - The target speed will be 30,000 pps set as double word in D0002.
    - After positioning is finished, the dwell time becomes 100ms set in D0004, and No.123 designated in D0005 will be output as the M code.
    - Since the control word of D0006 is H'20, the acceleration/deceleration pattern will follow the acceleration time 2 and deceleration time 2 of the basic parameter, and the positioning operation will be done as the absolute coordinates. If the DST instruction is started, the position control will be executed in the absolute coordinates, it will operate up to the 100,000 pulse at 30,000 pps, then stop, and after the dwell time of 100 ms passes, the positioning is finished, and M code outputs 123.
  - 2) If positioning is finished by direct starting, positioning finish signal (axis X:K4202) turns on for a scan.

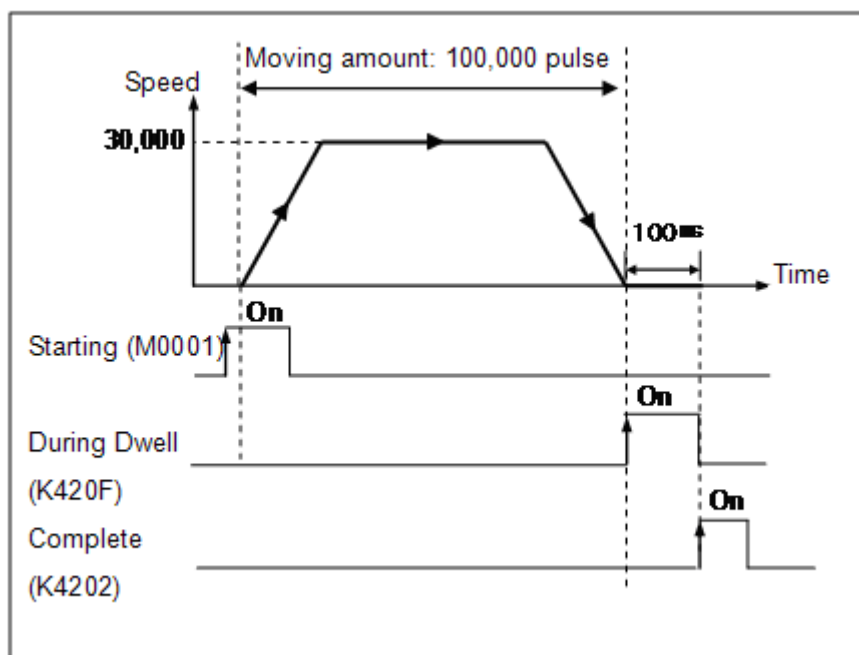

### 5.2.4 Indirect Starting Instruction

- Indirect starting refers to execution of the positioning operation by using the operation step data set in the positioning operation data.

#### (1) Indirect Starting Instruction (IST)

Instruction	Areas available														Step	Flag			
	PMK	F	L	T	C	S	Z	D.x	R.x	constant	U	N	D	R		Error (F110)	Zero (F111)	Carry (F112)	
IST	sl	-	-	-	-	-	-	-	-	-	○	-	-	-	-	4~7	○	-	-
	ax	○	-	○	-	-	-	○	-	-	○	-	-	○	-				
	n1	○	-	○	-	-	-	○	-	-	○	-	-	○	-				

#### [Area Setting]

Operand	Description	Setting range	Data size
sl	Slot No. of positioning module	XGB is fixed at 0	WORD
ax	Axis to give instruction	0 (axis X) or 1 (axis Y)	WORD
n1	Step number to start	0~30(standard), 0~80(advanced)	WORD

#### [Flag Set]

Flag	Description	Device number
Error	If the value of ax gets out of the range	F110

#### (a) Function

- This instruction is giving indirect starting instruction to XGB built-in positioning.
- The indirect starting is executed to the axis designated as ax of XGB positioning at the rising edge of the input condition.
- If the instruction is executed, the positioning operation is carried out by the operation data set in the step number of area K designated in n1. If n1 is set at 0, the operation step is executed which is displayed in the step number of current positioning area K (axis X:K426, axis Y:K436 word).
- Various operation patterns such as end, continued, and incessant operation, and single and repeated operation can be made and executed by using the indirect operation instruction.

#### (b) Error

- If the value designated as ax (instruction axis) is other than 0 and 1, the error flag (F110) is set and the instruction is not executed.
- In this case, execution of instruction is error. so K area error occurrence Flag(X axis:K4201, Y axis:K4301) doesn't turn On
- If the set value of the starting step number gets out of the settable range, instruction Error Flag(F110) is not set, the error flag of positioning area K (axis X:K4201, axis Y: K4301) turns On, and the operation does not occur.



## (2) Example of Use of the Instruction

- The indirect starting instruction is described with the example of the following program.
- The example of use of the IST instruction is described on the basis of axis X.

## (a) Example of the Program

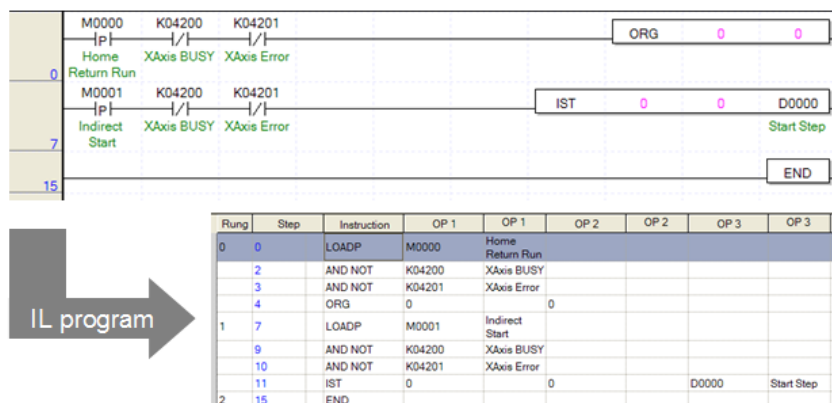

## (b) Device Used

Device	Description	Data size	Example of setting
M0000	axis X origin return instruction signal	BIT	-
M0001	axis X indirect starting instruction signal	BIT	-
K4200	signal during axis X operation	BIT	-
K4201	axis X error	BIT	-
D0000	Starting step number	WORD	3

Step No.	coordinates	Operation pattern	Control method	Operation mode	Repeated Step	Target position [Pulse]	M code	Acc./dec. No.	Operation speed[pls/s]	Dwell time [ms]
3	Incremental	end	position	single	0	7,000	0	1	100	10

## (c) Operation of the Program

- If there is the rising edge of M0001 used as the axis X indirect starting instruction signal, the IST instruction is executed. (Not if axis X is operating or in error.)
- If the origin is not fixed when the DST is started, error code 224 will appear and operation will not occur. In such a case, turn on M0000, execute the ORG instruction and thereby carry out the origin return, and start the DST instruction.

- 1) If the direct starting instruction (IST instruction) is executed, positioning operation starts as set in the operand as follows.
  - Since sl and ax are 0, built-in positioning axis X of the basic unit is started.
  - Because the starting step number is set as 3, positioning operation is carried out by the data of No. 3 step of the positioning operation data. That is, if the IST instruction is started, positioning control is conducted in the Incremental coordinates as set in operation data No. 3 step, moves up to 7,000 pulse at 100pps, stops, and when the dwell time of 10ms passes, positioning is finished.
- 2) Since M code is set at 0, it does not appear and as the operation pattern is End, the step number (axis X:K426) of area K is changed into 4, which is step + 1.

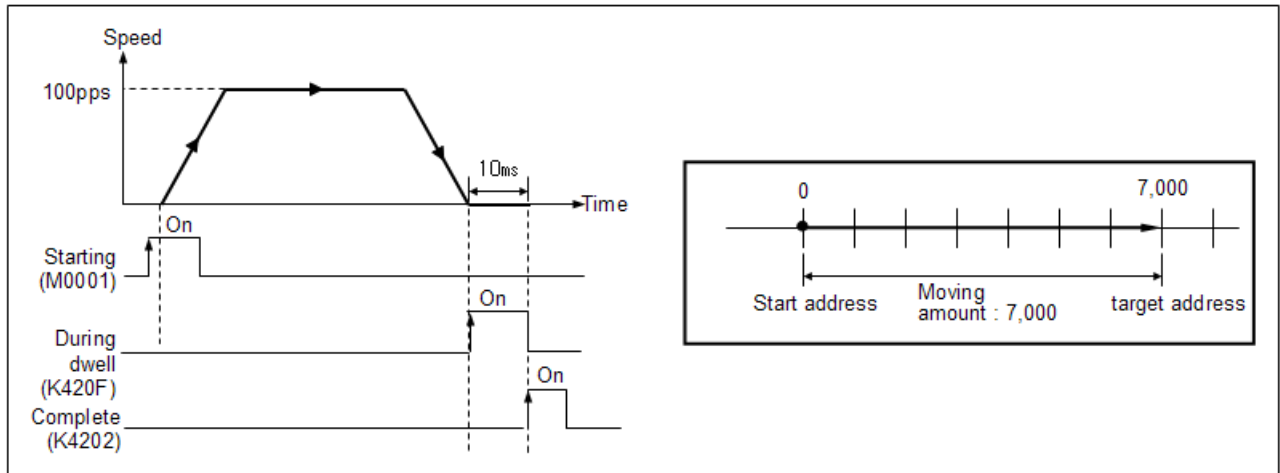

#### Remark

- In addition to executing indirect operation by using the IST instruction, indirect starting can also be started by using the starting signal instruction contact point (axis X:K4290, axis Y:K4390) of area K.
  - If starting is done by using the starting signal instruction contact point, the operation step is fixed at the current operation step number (axis X:K426, axis Y:K436).
  - Therefore if you want to change the operation step when starting by using the starting signal instruction contact point, change the operation step by using the Starting step number changing instruction and turn on the starting instruction contact point.
- For details, refer to 3.4.2.

### 5.2.5 Straight Interpolation Starting Instruction

- Straight interpolation starting refers to the operation so that the path of axes X and Y is straight from the starting address (current stop location) to the target address (target address).
- Straight interpolation control divides into control by absolute coordinates and Incremental coordinates. For details, refer to 3.1.2.
- When the instruction of straight interpolation starting is given, the axis where there is more movement is designated as the main axis. If the movements are equal, axis X is the main axis.
- The speed of the auxiliary axis does not follow the setting of the operation data, but conducts operation by calculating the operation speed, acceleration time, deceleration time, and bias speed automatically by the following operations.

$$\text{auxiliary axis speed} = \frac{\text{main axis speed} \times \text{auxiliary axis distance}}{\text{main axis distance}}$$

- main axis: the axis where there is more movement of positioning
- auxiliary axis: the axis where there is less movement of positioning

- The operation pattern that can use straight interpolation operation is limited to End and Continued operation. If the main axis is set as Continued and the interpolation operation is started, no error is issued in XGB built-in positioning but the operation pattern of the main axis is changed into Continued. If the auxiliary axis is set as Continued, it does not affect the straight interpolation.

#### (1) Straight Interpolation Starting Instruction (LIN)

Instruction	Areas available														Step	Flag					
	PMK	F	L	T	C	S	Z	D.x	R.x	constant	U	N	D	R		Error (F110)	Zero (F111)	Carry (F112)			
LIN	sl	-	-	-	-	-	-	-	-	-	○	-	-	-	4~7	○	-	-			
	ax	○	-	○	-	-	-	○	-	-	○	-	-	○					-	-	-
	n1	○	-	○	-	-	-	○	-	-	○	-	-	○					-	-	-
	n2	○	-	○	-	-	-	○	-	-	○	-	-	○					-	-	-

LIN		LIN	sl	ax	n1	n2
-----	--	-----	----	----	----	----

#### [Area Setting]

Operand	Description	Setting range	Data size
sl	Slot number of positioning module	XGB is fixed at 0	WORD
ax	Axis to give instruction	0 (axis X) or 1 (axis Y)	WORD
n1	Step number to carry out straight interpolation	0~30(standard), 0~80(advanced)	WORD
n2	Set the axis to carry out straight interpolation	XGB is set at 3	WORD

#### [Flag Set]

Flag	Description	Device number
Error	If the value of ax gets out of the range	F110

## Chapter 5 Positioning Instructions

### (a) Function

- This instruction is giving the straight interpolation starting instruction to XGB built-in positioning.
- The two axes of XGB positioning conduct straight interpolation starting at the rising edge of input condition.
- If the instruction is executed, the two axes of XGB positioning carried out the straight interpolation operation according to the axis setting designated in n2. The step number to be operated is the step number set in n1.
- In setting of the axis of n2, the axis to carry out the straight interpolation operation as follows.

Bit number	15 ~ 3	2	1	0
Setting	Not used	Axis Z (XGB is not used)	axis Y	axis X

- Each bit refers to the axis to start the straight interpolation. In the case of XGB built-in positioning, n2 should be fixed as 3 since only axis X and axis Y are available. Otherwise, error code 253 is issued and it does not operate.

### (b) Error

- If the value designated as ax (instruction axis) is other than 0 and 1, the error flag (F110) is set and the instruction is not executed.
- Since this case if an error of execution of the instruction, the error in positioning area K error flag(axis X:K4201, axis Y: K4301) does not turn On..
- If the set value of the starting step number gets out of the settable range, instruction Error Flag(F110) is not set, the error flag of positioning area K (axis X:K4201, axis Y: K4301) turns On, and the operation does not occur.

## (2) Example of Use of the Instruction

### (a) Example of the Program

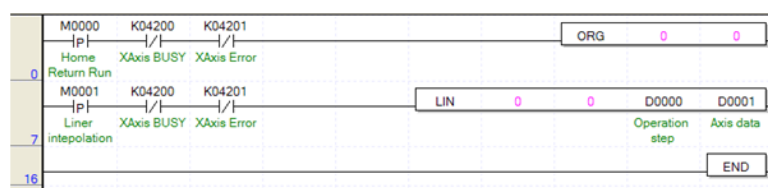

Run#	Step	Instruction	OP 1	OP 1 comment	OP 2	OP 2	OP 3	OP 3	OP 4	OP 4
0	0	LOADP	M0000	Home Return Run						
2	2	AND NOT	K04200	XAxis BUSY						
3	3	AND NOT	K04201	XAxis Error						
4	4	ORG	0	0						
1	7	LOADP	M0001	Linear interpolation						
9	9	AND NOT	K04200	XAxis BUSY						
10	10	AND NOT	K04201	XAxis Error						
11	11	LIN	0	0	D0000	Operation step	D0001	Axis data		
2	16	END								

### (b) Device Used

Device	Description	Data size	Example of setting
M0000	axis X origin return instruction signal	BIT	-
M0001	Interpolation starting instruction signal	BIT	-
K4200	signal during axis X operation	BIT	-
K4201	axis X error	BIT	-
D0000	Operation step number	WORD	10
D0001	Axis information	WORD	3

Axis	Step No.	coordinates	Operation pattern	Control method	Operation mode	Repeated Step	Target position [Pulse]	M code	Acc./dec. No.	Operation speed[pls/s]	Dwell time [ms]
X	10	Rel.	End	position	Single	0	7,000	0	1	100	10
Y	10	Rel.	End	position	Single	0	2,000	0	2	300	10

## (c) Operation of the Program

- The LIN instruction is executed if the rising edge of M0001 is generated which was used as the instruction signal of the straight interpolation starting.  
(If it is in operation of axis X or in error, it does not operate. If axis Y is in operation, error code 242 is issued and it does not operate)
  - 1) If the straight interpolation instruction (LIN instruction) is executed, the straight interpolation operation is started as set in operand.
  - 2) Since sl is 0, built-in positioning of the basic unit operates straight interpolation.
    - Because the starting step number is set as 3, positioning operation is carried out by the data of No. 3 step of the positioning operation data. That is, if the IST instruction is started, positioning control is conducted in the Incremental coordinates as set in operation data No. 3 step, moves up to 7,000 pulse at 100pps, stops, and when the dwell time of 10ms passes, positioning is finished.
  - 3) As the ax is set at 0, the straight interpolation instruction for axis X is started. (For actual zero, the main and auxiliary axes of axis X and axis Y are calculated according to the size of the target position for starting, to the ax operand does not affect the operation)
  - 4) Since the step number of n1 operation is set at 10, the main and auxiliary axes are automatically selected by No. 10 operation data of axis X and axis Y. (In this example, because the target position of axis X is larger, axis X is the main axis and axis Y is the auxiliary axis.)
  - 5) The acceleration and deceleration time and speed of axis Y, which is the auxiliary axis, does not follow the set value but automatically calculated for operation.
  - 6) That is, axis X and axis Y are designated as the main and auxiliary axes respectively by starting of the LIN instruction, it moves by (7000,2000) to the relative position and the operation ends.

### 5.2.6 Simultaneous Starting Instruction

- The simultaneous starting instruction (SST instruction) is for simultaneously starting the steps of the axes set in the instruction. For details, refer to 3.1.7.

(1) simultaneous starting instruction (SST)

Instruction	Areas available														Step	Flag			
	PMK	F	L	T	C	S	Z	D.x	R.x	constant	U	N	D	R		Error (F110)	Zero (F111)	Carry (F112)	
SST	sl	-	-	-	-	-	-	-	-	-	○	-	-	-	-	4~7	○	-	-
	ax	○	-	○	-	-	-	○	-	-	○	-	-	○	-				
	n1	○	-	○	-	-	-	○	-	-	○	-	-	○	-				
	n2	○	-	○	-	-	-	○	-	-	○	-	-	○	-				
	n3	○	-	○	-	-	-	○	-	-	○	-	-	○	-				
	n4	○	-	○	-	-	-	○	-	-	○	-	-	○	-				

[Area Setting]

Operand	Description	Setting range	Data size
sl	Slot No. of positioning module	XGB is fixed at 0	WORD
ax	Axis to give instruction	0 (axis X) or 1 (axis Y)	WORD
n1	axis X Step No.	0~30(standard), 0~80(advanced)	WORD
n2	axis Y Step No.	0~30(standard), 0~80(advanced)	WORD
n3	axis Z Step No.	Not used	WORD
n4	Axis setting	XGB is set at 3	WORD

[Flag Set]

Flag	Description	Device number
Error	If the value of ax gets out of the range	F110

(a) Function

- This function is for giving the simultaneous starting instruction to XGB built-in positioning simultaneous starting.
- The two axes of XGB positioning are simultaneously started at the rising edge of the input condition. (For the difference between using the simultaneous starting instruction and starting the two axes consecutively in the PLC ladder program, refer to 3.1.7.)
- When the instruction is executed, axis X and axis Y simultaneously start by using the operation data of the step number set in n1 and n2 respectively. XGB built-in positioning does not have axis Z, so the set value of n3 does not affect the operation.
- Axis setting of n4 sets the axis to carry out simultaneous starting by bit as follows.

Bit No.	15 ~ 3	2	1	0
Setting	Not used	Axis Z (XGB not used)	axis Y	axis X

- Each bit refers to the axis to start straight interpolation. In the case of XGB built-in positioning, only axis X and axis Y are available, so n4 should be fixed at 3. Otherwise, error code 296 is issued and operation does not occur.

(b) Error

- If the value designated as ax (instruction axis) is other than 0 and 1, the error flag (F110) is set and the instruction is

not executed.

- Since this case if an error of execution of the instruction, the error in positioning area K error flag(axis X:K4201, axis Y: K4301) does not turn On..
- If the set value of the starting step number gets out of the settable range, instruction Error Flag(F110) is not set, the error flag of positioning area K (axis X:K4201, axis Y: K4301) turns On, and the operation does not occur.

(2) Example of Use of the Instruction

- The instruction is described with the example of the following program simultaneous starting instruction.

(a) Example of the Program

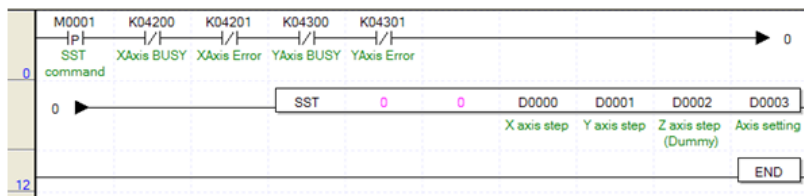

Axis	Step	Instruction	OP1	OP1 used	OP2	OP2 used	OP3	OP3 used	OP4	OP4 used	OP5	OP5 used	OP6	OP6 used
0	0	SST	0											
1	0	END												

(b) Device Used

Device	Description	Data size	Example of setting
M0001	simultaneous starting instruction signal	BIT	-
K4200	signal during axis X operation	BIT	-
K4201	axis X error	BIT	-
K4300	signal during axis Y operation	BIT	-
K4301	axis Y Error	BIT	-
D0000	axis X operation Step No.	WORD	1
D0001	axis Y operation Step No.	WORD	2
D0002	axis Z operation Step No.	WORD	-
D0003	Axis setting	WORD	3

Axis	Step No.	coordinates	Operation pattern	Control method	Operation mode	Repeated Step	Target position [Pulse]	M code	Acc./dec. No.	Operation speed[pls/s]	Dwell time [ms]
X	1	Rel.	End	position	Single	0	7,000	0	1	100	10
Y	2	Rel.	End	Position	Single	0	2,000	0	2	300	10

(c) Operation of the Program

- SST instruction is executed it the rising edge of M0001, which was used as the instruction signal of the simultaneous starting is generated.
  - 1) If the simultaneous starting instruction (SST) is executed, the two axes are simultaneously started as set in the operand as follows.
  - 2) Since sl is 0, built-in positioning of the basic unit operates simultaneous starting.
  - 3) If the set value of ax does not exceed the setting range, it does not affect the operation.
  - 4) Since the step numbers of axis X and axis Y are set 1 and 2 respectively, the two axes are simultaneously started by using the operation data of the operation step.
  - 5) Since there is no axis Z in XGB built-in positioning, even if a random value is input as the step number of axis Z operation, the operation is not affected.

### 5.2.7 Speed Position Switching Instruction

- This is positioning according to the target position by switching the axis operated by speed control to position control through speed/position switching instruction (VTP instruction). For details, refer to 3.1.4.

#### (1) Speed/Position Switching Instruction (VTP)

Instruction	Areas available														Step	Flag			
	PMK	F	L	T	C	S	Z	D.x	R.x	constant	U	N	D	R		Error (F110)	Zero (F111)	Carry (F112)	
VTP	sl	-	-	-	-	-	-	-	-	-	○	-	-	-	-	4~7	○	-	-
	ax	○	-	○	-	-	-	○	-	-	○	-	-	○	-				

#### [Area Setting]

Operand	Description	Setting range	Data size
sl	Slot No. of positioning module	XGB is fixed at 0	WORD
ax	Axis to give instruction	0 (axis X) or 1 (axis Y)	WORD

#### [Flag Set]

Flag	Description	Device number
Error	If the value of ax gets out of the range	F110

#### (a) Function

- This instruction is giving the speed/position control switching instruction to XGB built-in positioning.
- The axis designated as ax at the rising edge in the input condition is switched from the speed operation to position operation.
- The current position which was output during the previous speed control operation is initialized to 0 and operated to the target position by absolute coordinates method.

#### (b) Error

- If the value designated as ax (instruction axis) is other than 0 and 1, the error flag (F110) is set and the instruction is not executed.

#### (2) Example of Use of the Instruction

- The program speed/position control switching instruction is described with the following example.

##### (a) Example of the Program



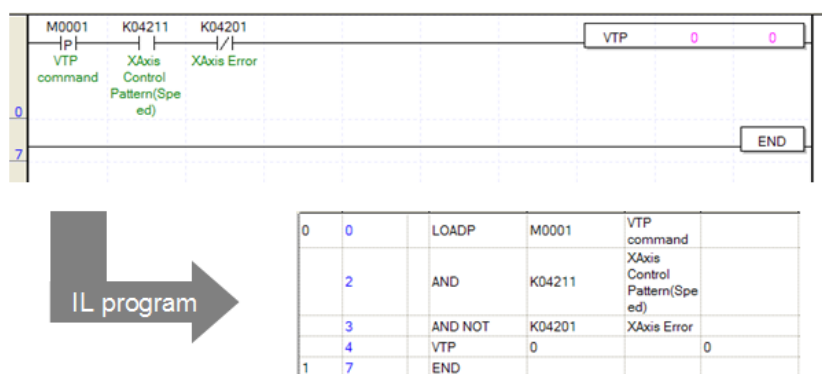

## (b) Device Used

Device	Description	Data size	Example of setting
M0001	speed/position switching instruction signal	BIT	-
K4211	Signal during axis X speed control	BIT	-
K4201	axis X error	BIT	-

## (c) Operation of the Program

- VTP instruction is executed when there is the rising edge of M0001, which was used as the speed/position switching instruction signal.
- If the speed control is going on currently, it is switched into position control, the current position is preset to 0, and position control is carried out up to the target position. Now the target position divides into the following cases according to the direct and indirect starting.
  - 1) In case of indirect starting, the target position of the operating step becomes the target position after the speed position switching.
  - 2) In case of direct starting, the target position set as the operand in the DST instruction becomes the target position after the speed position switching
- When using the speed/position switching instruction, make sure that the instruction is not executed during the position operation by using the display flag (axis X:K4211, axis Y:K4311) during speed control as the program example above.

### 5.2.8 Position Speed Switching Instruction

- This is operation by switching the axis operating by the current position control into speed control by the position/speed switching instruction (PVT instruction). For details, refer to 3.1.5.

#### (1) Position/Speed Switching Instruction (PTV)

Instruction	Areas available														Step	Flag		
	PMK	F	L	T	C	S	Z	D.x	R.x	Constant	U	N	D	R		Error (F110)	Zero (F111)	Carry (F112)
PTV	sl	-	-	-	-	-	-	-	-	-	○	-	-	-	4~7	○	-	-
	ax	○	-	○	-	-	-	○	-	-	○	-	-	○				

#### [Area Setting]

Operand	Description	Setting range	Data size
sl	Slot No. of positioning module	XGB is fixed at 0	WORD
ax	Axis to give instruction	0 (axis X) or 1 (axis Y)	WORD

#### [Flag Set]

Flag	Description	Device number
Error	If the value of ax gets out of the range	F110

#### (a) Function

- This instruction is giving the position/speed control switching instruction to XGB built-in positioning.
- The axis designated as ax at the rising edge in the input condition is switched from the position operation to speed operation.
- The current position which was output during the previous speed control operation is not initialized to 0 and only the control method is switched to speed control with the operation continued.

#### (b) Error

- If the value designated as ax (instruction axis) is other than 0 and 1, the error flag (F110) is set and the instruction is not executed.

#### (2) Example of Use of the Instruction

- The position/speed control switching instruction is described with the example of the following program.

##### (a) Example of the Program

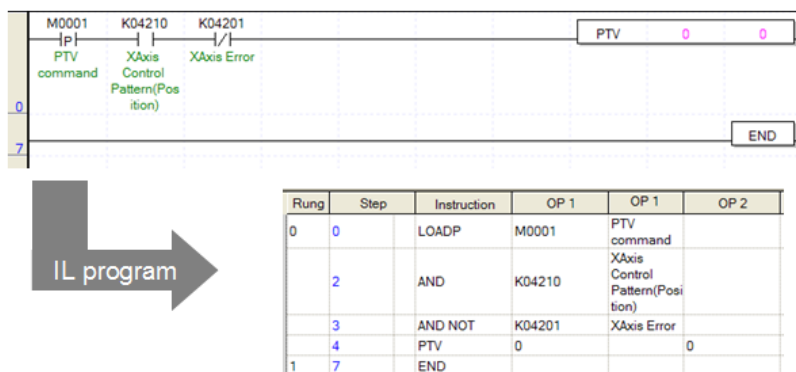

## (b) Device Used

Device	Description	Data size	Example of setting
M0001	position/speed switching instruction signal	BIT	-
K4210	signal during axis X position control	BIT	-
K4201	axis X error	BIT	-

## (c) Operation of the Program

- PVT instruction is executed when there is the rising edge of M0001, which was used as the position/speed switching instruction signal.
- If the position control is going on currently, it is switched into speed control, and the current position is not preset but only the control method is switched to speed control.
- When using the position/speed switching instruction, make sure that the instruction is not executed during the speed operation by using the display flag (axis X:K4210, axis Y:K4310) during position control as the program example above.
- To stop the operation after switching to speed control, use the stop instruction (STP).

### 5.2.9 Deceleration Stop Instruction

- The currently operating axis is decelerated and stopped at the speed designated by the deceleration stop instruction (STP instruction). For details, refer to 3.1.11.

#### (1) Deceleration Stop Instruction (STP)

Instruction	Areas available														Step	Flag			
	PMK	F	L	T	C	S	Z	D.x	R.x	constant	U	N	D	R		Error (F110)	Zero (F111)	Carry (F112)	
STP	sl	-	-	-	-	-	-	-	-	-	○	-	-	-	-	4-7	○	-	-
	ax	○	-	○	-	-	-	○	-	-	○	-	-	○	-				
	n1	○	-	○	-	-	-	○	-	-	○	-	-	○	-				

#### [Area Setting]

Operand	Description	Setting range	Data size
sl	Slot No. of positioning module	XGB is fixed at 0	WORD
ax	Axis to give instruction	0 (axis X) or 1 (axis Y)	WORD
n1	deceleration time	0~65535	WORD

#### [Flag Set]

Flag	Description	Device number
Error	If the value of ax gets out of the range	F110

#### (a) Function

- This instruction is giving the deceleration stop instruction to XGB built-in positioning.
- The axis designated as ax at the rising edge of the input condition conducts deceleration stop for the deceleration time set in the corresponding operation step.

#### (b) Error

- If the value designated as ax (instruction axis) is other than 0 and 1, the error flag (F110) is set and the instruction is not executed.

#### Remark

- If the deceleration time is set at 0, it stops right away without deceleration in XGB positioning. In this case, note that there might be shock noise or damage to the motor.
- If the deceleration time of n1 is set at 0, it stops right away without deceleration. Otherwise, it stops according to the operation data of the operation data and the acceleration/deceleration number set in the DST instruction respectively in case of indirect starting and direct starting.

## (2) Example of Use of the Instruction

- The deceleration stop instruction is described with the example of the following program.

## (a) Example of the Program

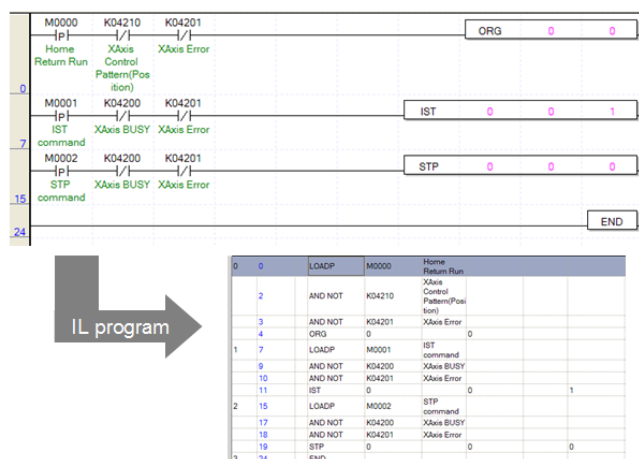

## (b) Device Used

Device	Description	Data size	Example of setting
M0000	origin return instruction signal	BIT	-
M0001	Indirect starting instruction signal	BIT	-
M0002	Deceleration stop instruction signal	BIT	-
K4200	signal during axis X position control	BIT	-
K4201	axis X error	BIT	-

## (c) Operation of the Program

- IST instruction is executed when there is the rising edge of M0001, which was used as the indirect starting instruction signal.
  - In the program above, the indirect starting of No. 1 step of axis X is executed.
- If there is the rising edge of M0002, which is the deceleration stop instruction signal during operation, the deceleration stop instruction is executed according to the setting of STP instruction.
  - Since sl (first Operand) and ax(second Operand) are set at 0, the deceleration stop is executed for axis X of basic unit built-in positioning.
  - Since the deceleration time is set at 0, if the STP instruction is executed, it stops right away without deceleration.
- Note the following in executing the STP instruction.
  - If it has been stopped by the deceleration stop instruction, because the positioning operation has not been finished to the set target position, no positioning completion signal (axis X:K4202, axis Y:K4302) is generated, and if M code is set, the M code signal does not turn On either.
  - In this case, the operation step number maintains the current step.
  - If the indirect starting instruction is executed again afterwards, the operation methods differs according to the coordinates type.
    - Absolute coordinates: The remaining position output which has not been output from the current operation step is output.
    - Incremental coordinates: Operation is conducted as much as the new target position.
  - For example, if the target value of the corresponding step is 20,000 and it has been stopped at 15,000 by the deceleration stop instruction, and if the indirect starting is executed again, in case of absolute coordinates, operation is done as much as 5,000 and stops at 20,000, and in case of Incremental coordinates, it newly moves 20,000 and stops at 35,000.

### 5.2.10 Main axis position synchronous Instruction

- As follows, this is the instruction for synchronous starting according to the current position of the main axis with the axis set in the SSP being the auxiliary axis. For details, refer to 3.1.8.

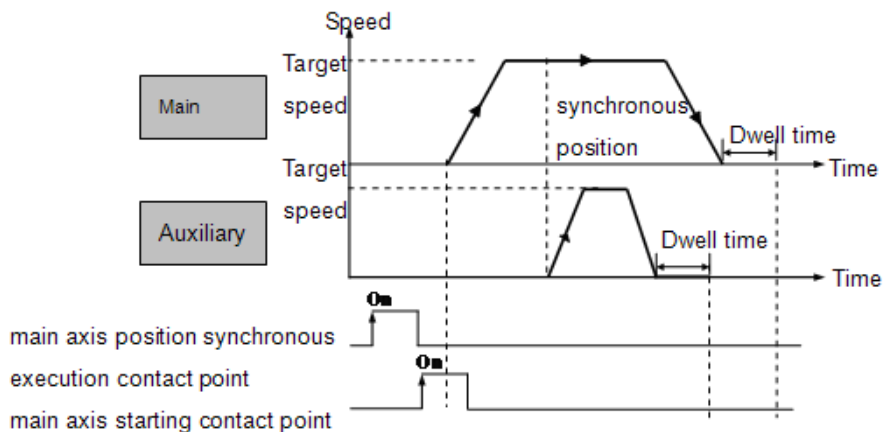

#### (1) Main axis position synchronous Starting Instruction (SSP)

Instruction	Areas available														Step	Flag					
	PMK	F	L	T	C	S	Z	D.x	R.x	Constant	U	N	D	R		Error (F110)	Zero (F111)	Carry (F112)			
SSP	sl	-	-	-	-	-	-	-	-	-	○	-	-	-	4~7	○	-	-			
	ax	○	-	○	-	-	-	○	-	-	○	-	-	○					-	-	-
	n1	○	-	○	-	-	-	○	-	-	○	-	-	○					-	-	-
	n2	○	-	○	-	-	-	○	-	-	○	-	-	○					-	-	-
	n3	○	-	○	-	-	-	○	-	-	○	-	-	○					-	-	-

SSP		COMMAND		SSP	sl	ax	n1	n2	n3
-----	--	---------	--	-----	----	----	----	----	----

#### [Area Setting]

Operand	Description	Setting range	Data size
sl	Slot No. of positioning module	XGB is fixed at 0	WORD
ax	Axis to give instruction	0 (axis X) or 1 (axis Y)	WORD
n1	Position value of the main axis position synchronous main axis	-2,147,483,648 ~ 2,147,483,647	DINT
n2	Operation step number of auxiliary axis	0~30(standard), 0~80(advanced)	WORD
n3	Setting of the main axis of position synchronous	0 (axis X) or 1 (axis Y)	WORD

#### [Flag Set]

Flag	Description	Device number
Error	If the value of ax gets out of the range	F110

#### (a) Function

- This instruction is executing main axis position synchronous starting for the XGB built-in positioning.
- The main axis position synchronous instruction is executed with the axis set in the axis designated as ax at the rising edge of the input condition auxiliary axis, n3 being the main axis.

- If the instruction is executed, the auxiliary axis stands by without generating actual pulse (the operation status flag of the auxiliary axis (axis X:K4200, axis Y:K4300) turns On), and n2 step of the auxiliary axis is started when n3 axis, which is the main axis, is positioned as set in n1.
- The position synchronous starting instruction can be executed only when the origins of both the main axis and auxiliary axis are fixed. If the origin of the main axis is not decided when the main axis position synchronous instruction (SSP) is started, error code 346 is issued, and if the origin of the auxiliary axis is not decided when the main axis position synchronous instruction (SSP) is started, error code 344 is issued.
- When you use the main axis position synchronous instruction, set the main axis and auxiliary axis at different axes. If they are set at the same axis, error code 347 is issued.
- If you want to cancel the main axis position synchronous instruction after you executed it, execute the stop instruction of the auxiliary axis (STP).

## (b) Error

- If the value designated as ax (instruction axis) is other than 0 and 1, the error flag (F110) is set and the instruction is not executed.

## (2) Example of Use of the Instruction

- The main axis position synchronous starting instruction is described with the example of the following program.

## (a) Example of the Program

- The following program example is starting No.1 step operation data of the auxiliary axis when axis Y is the auxiliary axis and axis X is the main axis, and the position of the main axis is 10,000.

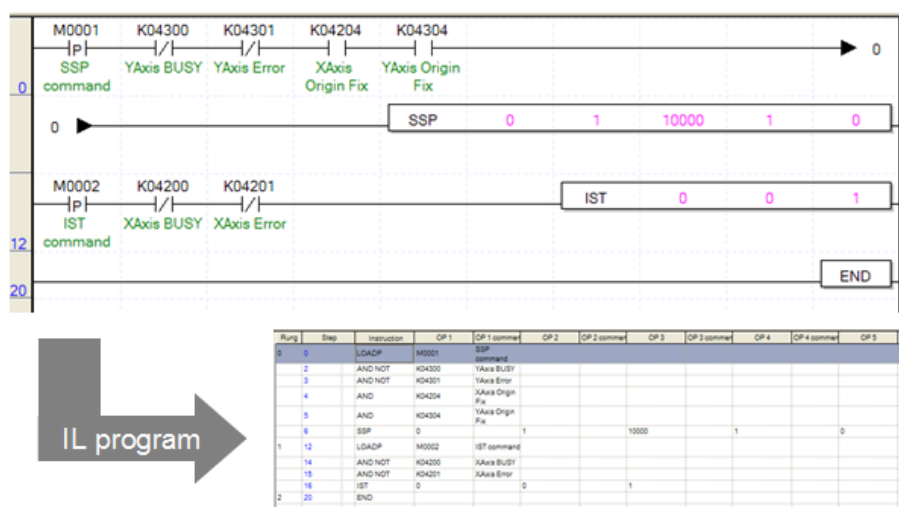

## (b) Device Used

Device	Description	Data size	Example of setting
M0001	main axis position synchronous instruction signal	BIT	-
M0002	main axis instruction signal	BIT	-
K4300	Signal during auxiliary axis (axis Y) position control	BIT	-
K4301	auxiliary axis(axis Y) Error	BIT	-
K4204	axis X origin fixed	BIT	-
K4304	axis Y origin fixed	BIT	-
K4200	Signal during the main axis(axis X) position control	BIT	-
K4201	main axis(axis X) Error	BIT	-

## (c) Operation of the Program

- The SSP instruction is executed if there is the rising edge of M0001, which was used as the main axis position synchronous instruction signal.  
Since the second operand is 1 (axis Y), axis Y is the auxiliary axis, and as the fifth operand is 0(axis X), so the main axis is axis X.
- No.1 step of axis X is indirectly started if there is the rising edge of M0002, which is the indirect starting instruction signal of the main axis.
- When the current position of the main axis during operation becomes 10,000[Pulse], set in the third operand of the SSP instruction, axis Y, which is the auxiliary axis, starts No. 1 step, which is the operation step set in the fourth operand of the SSP instruction.

## Remark

- When you use the main axis position synchronous instruction, if the axis set as the main axis has already been started as the main axis position synchronous auxiliary axis, error code 349 is issued and it is not executed. If the following example, axis Y becomes the auxiliary axis and axis X becomes the main axis at the rising edge of M0001 and the main axis position synchronous instruction is executed. If there is the rising edge of M0100, the position synchronous instruction is issued with axis X being the auxiliary axis and axis Y being the main axis. In this case, since axis Y used as the main axis, is already being started as the auxiliary axis of the main axis position synchronous instruction, axis X generates error code 349 and is not started.

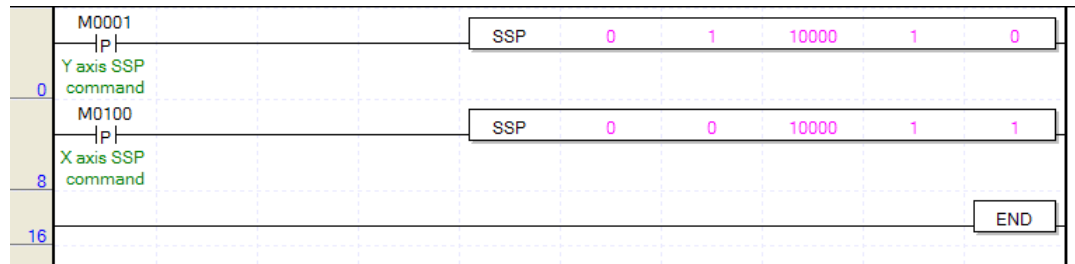



### 5.2.11 Speed Synchronous Instruction

- The speed synchronous instruction (SSS instruction) is for speed synchronization at the set synchronous speed rate and operation when the main axis is started with the axis set in the instruction being the auxiliary axis. For details, refer to 3.1.8.

#### (1) Speed Synchronous Starting Instruction (SSS)

Instruction	Areas available														Step	Flag			
	PMK	F	L	T	C	S	Z	D.x	R.x	constant	U	N	D	R		Error (F110)	Zero (F111)	Carry (F112)	
SSS	sl	-	-	-	-	-	-	-	-	-	○	-	-	-	-	4~7	○	-	-
	ax	○	-	○	-	-	-	○	-	-	○	-	-	○	-				
	n1	○	-	○	-	-	-	○	-	-	○	-	-	○	-				
	n2	○	-	○	-	-	-	○	-	-	○	-	-	○	-				
	n3	○	-	○	-	-	-	○	-	-	○	-	-	○	-				

#### [Area Setting]

Operand	Description	Setting range	Data size
sl	Slot No. of positioning module	XGB is fixed at 0	WORD
ax	Axis to give instruction	0 (axis X) or 1 (axis Y)	WORD
n1	speed synchronous ratio	1 ~ 10,000(0.01% ~ 100.00%)	WORD
n2	Delay time	1 ~ 10[ms]	WORD
n3	Speed delay main axis setting	See 0 ~ 9 '(1) Function'	WORD

#### [Flag Set]

Flag	Description	Device number
Error	If the value of ax gets out of the range	F110

#### (a) Function

- This instruction is for executing the speed synchronous starting for synchronous starting.
- The axis set in the axis designated as ax at the rising edge of the input condition auxiliary axis, n3 becomes the main axis and the speed main axis position synchronous starting instruction is executed.
- If the instruction is executed, the auxiliary axis stands by without generating actual pulse (the operation status flag of the auxiliary axis (axis X:K4200, axis Y:K4300) turns On), and n3 axis, which is the main axis, it is started according to the speed synchronous ratio set in n1.
- The synchronous ratio settable in n1 is 0.01% ~ 100.00% (set value 1 ~ 10,000). If the set speed ratio gets out of this range, error code 356 is issued.
- The delay time of n2 refers to the delay time it takes for speed of the auxiliary axis to reach the current main axis speed. In XGB built-in positioning, when controlling the speed synchronization, the speed of the current main axis is detected every 500  $\mu$ s, and thereby the speed of the auxiliary axis is adjusted. If the speed of the auxiliary axis is synchronized to the current main axis speed without a delay time and immediately changed, there might be damage or shock noise to the motor due to the sudden change of the auxiliary axis speed.  
For example, assuming the speed ratio is 100.00% and the delay time is 5[ms], if the speed of the main axis is 10,000[pps], the XGB built-in positioning adjusts the speed of the auxiliary axis according to the speed of the main axis every 500[ $\mu$ s] by adjusting the current speed for the speed of the auxiliary axis to reach 10,000[pps].

## Chapter 5 Positioning Instructions

The longer the delay time, the longer the delay time between the main axis and auxiliary axis, but the output pulse is stably output. If there is likely to be step out of the motor, lengthen the delay time.

- The delay time settable for n2 is 1 ~ 10[ms]. If it gets out of the settable range, error code 357 is issued.
- The main axis of n3 is settable between 0 and 9. If it gets out of the settable range, error code 355 is issued

Set value	Main axis setting	Remark
0	axis X	
1	axis Y	
2	High speed counter Ch0	
3	High speed countCh1	
4	High speed countCh2	
5	High speed countCh3	
6	High speed counter Ch4	Only the advanced type is settable.
7	High speed counter Ch5	
8	High speed counter Ch6	
9	High speed counter Ch7	

- If you want to cancel the speed synchronous instruction after you execute it, execute the stop instruction (STP) for the auxiliary axis.
- The speed synchronous control is executable even when the origin is not fixed.
- The speed synchronous control is synchronized to the speed of the main axis for operation of the auxiliary axis, so even if the control method of the auxiliary axis is set as position control, starting and stop are alternated by the operation of the main axis, with the rotation of the auxiliary axis being in the same direction as the main axis.
- If the M code of the auxiliary axis is On when you execute the speed synchronous instruction, error code 353 is issued.

### (b) Error

- If the value designated as ax (instruction axis) is other than 0 and 1, the error flag (F110) is set and the instruction is not executed.

### (2) Example of Use of the Instruction

- The speed synchronous starting instruction is described with the example of the following program.

#### (a) Example of the Program

- The following program example is about speed synchronous starting with the synchronization ratio 100.00[%] and the delay time being 10[ms] when the main axis is started if axis Y is the auxiliary axis and axis X is the main axis.

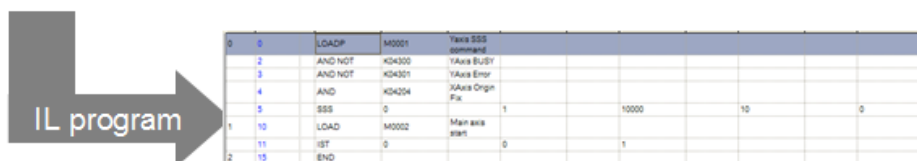
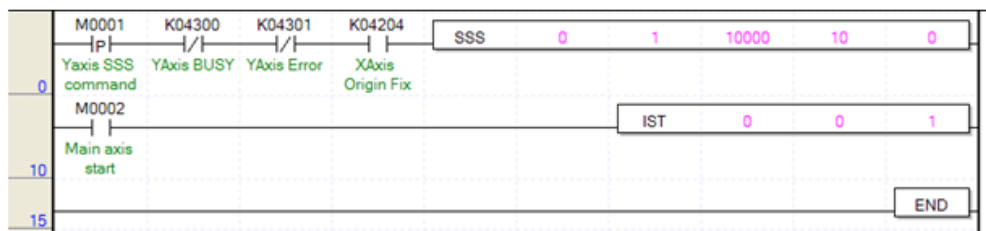

## (b) Operation of the Program

- SSS instruction is executed if there is the rising edge of M0001, which was used as the speed synchronous instruction signal. Since the second operand is 1(axis Y), axis Y becomes the auxiliary axis, and because the fifth operand is 0(axis X), the main axis is axis X.
- If there is the rising edge of M0002, which is the indirect starting instruction signal of the main axis, No. 1 step of axis X is indirectly started.
- When the main axis is started, axis Y is started at the synchronous ratio speed of 100.00[%] set in the third operand of SSS instruction, and is synchronized to the main axis with the delay time of 10[ms] set in the fourth operand for operation.

## 5.2.12 Position Override Instruction

- The position override instruction (POR) is for changing the target position of the axis being operated for the current positioning into the target position set in the instruction. For details, refer to 3.1.10.

## (1) position override instruction (POR)

Instruction	Areas available														Step	Flag			
	PMK	F	L	T	C	S	Z	D.x	R.x	constant	U	N	D	R		Error (F110)	Zero (F111)	Carry (F112)	
POR	sl	-	-	-	-	-	-	-	-	-	○	-	-	-	-	4~7	○	-	-
	ax	○	-	○	-	-	-	○	-	-	○	-	-	○	-				
	n1	○	-	○	-	-	-	○	-	-	○	-	-	○	-				

## [Area Setting]

Operand	Description	Settable range	Data size
sl	Slot No. of positioning module	XGB is fixed at 0	WORD
ax	Axis to give instruction	0 (axis X) or 1 (axis Y)	WORD
n1	Target position to change	-2,147,483,648 ~ 2,147,483,647	DINT

## [Flag Set]

Flag	Description	Device number
Error	If the value of ax gets out of the range	F110

## (a) Function

- This instruction is giving the position override instruction to the XGB built-in positioning.
- This is changing the target position to the position set in n1 during the operation of the axis designated as ax at the rising edge of the input condition.
- The position override instruction is available in the acceleration and deceleration sections and if the position override is executed during dwell, error code 362 is issued.

## (b) Error

- If the value designated as ax (instruction axis) is other than 0 and 1, the error flag (F110) is set and the instruction is not executed.

## (2) Example of Use of the Instruction

- The position override instruction is described with the example of the following program.

## (a) Example of the Program

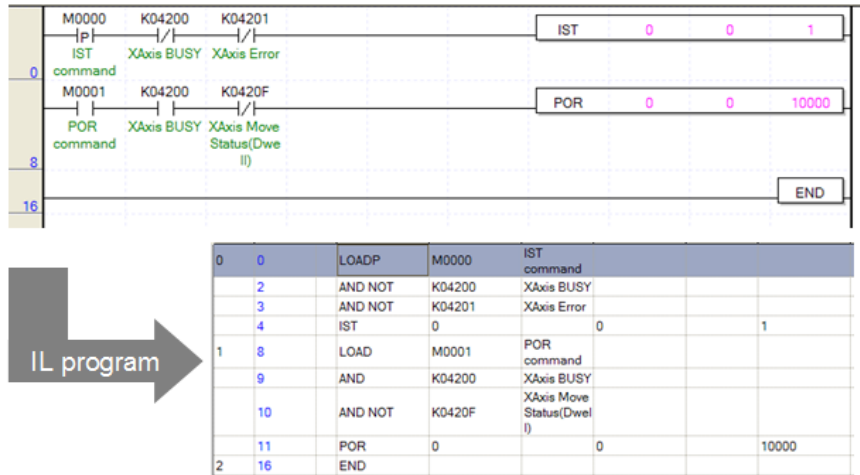

## (b) Operation of the Program

- The positioning axis X is indirectly started with operation step 1 when there is the rising edge of M0000 used as the indirect starting instruction signal.
- If there is the rising edge of M0001 used as the instruction signal of the position override instruction before the current position during operation reaches 100,000 [Pulse], operation continues by changing the target position of the currently operating step into 100,000. (Note that the value of the target position of No. 1 step set in the positioning parameter is not changed)
- If the position override instruction is executed when the current position has passed 100,000[Pulse], it is decelerated and stops.
- If the position override instruction is executed during dwell operation, error code 362 is issued. To prevent this, make the program by connecting the axis X dwell flag to the starting contact point with the normally closed contact point (contact point B).

### 5.2.13 Speed Override Instruction

- The speed override instruction (SOR) is for changing the operation speed of the axis during current positioning operation into the speed set in the instruction. For details, refer to 3.1.10.

#### (1) Speed Override Instruction (SOR)

Instruction	Areas available														Step	Flag			
	PMK	F	L	T	C	S	Z	D.x	R.x	constant	U	N	D	R		Error (F110)	Zero (F111)	Carry (F112)	
SOR	sl	-	-	-	-	-	-	-	-	-	○	-	-	-	-	4~7	○	-	-
	ax	○	-	○	-	-	-	○	-	-	○	-	-	○	-				
	n1	○	-	○	-	-	-	○	-	-	○	-	-	○	-				

#### [Area Setting]

Operand	Description	Setting range	Data size
sl	Slot No. of positioning module	XGB is fixed at 0	WORD
ax	Axis to give instruction	0 (axis X) or 1 (axis Y)	WORD
n1	Operation speed to change	0 ~ 100,000[pps]	DWORD

#### [Flag Set]

Flag	Description	Device number
Error	If the value of ax gets out of the range	F110

#### (a) Function

- This instruction is giving the speed override instruction to XGB built-in positioning.
- This is for changing the operation speed into the speed set in n1 during the operation of the axis designated as ax at the rising edge of the input condition.
- The speed override instructions available in the acceleration and constant speed sections and if the speed override is executed during deceleration or dwell, error code 377 is issued and the currently operating operation step continues.

#### (b) Error

- If the value designated as ax (instruction axis) is other than 0 and 1, the error flag (F110) is set and the instruction is not executed.

#### (2) Example of Use of the Instruction

- The speed override instruction is described with the example of the following program.

## (a) Example of the Program

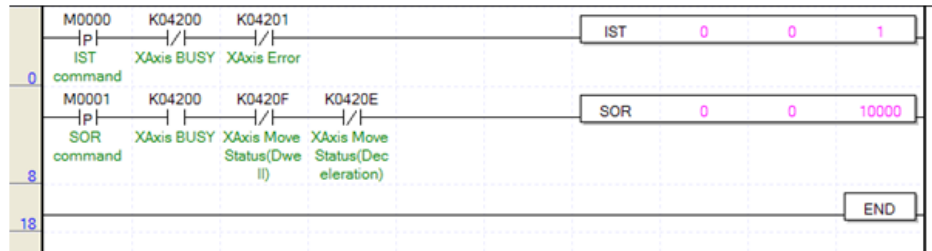

IL program

0	0	LOADP	M0000	IST			
	2	AND NOT	K04200	XAxis BUSY			
	3	AND NOT	K04201	XAxis Error			
	4	IST	0		0		1
1	8	LOADP	M0001	SOR			
	10	AND	K04200	XAxis BUSY			
	11	AND NOT	K0420F	XAxis Move Status(Dwell)			
	12	AND NOT	K0420E	XAxis Move Status(Deceleration)			
	13	SOR	0		0		10000
2	18	END					

## (b) Operation of the Program

- The positioning axis X is indirectly started with operation step 1 if there is the rising edge of M0000 used as the indirect starting instruction signal.
- If there is the rising edge of M0001 used as the instruction signal of the speed override instruction during operation, operation continues by changing the speed of the currently operating step into 10,000[pps]. (Note that the value of the operation speed of No. 1 step set in the positioning parameter is not changed)
- If the speed override instruction is executed during deceleration or dwell, error code 377 is issued. To prevent this, make the program by connecting the axis X dwell flag to the starting contact point with the normally closed contact point (contact point B).

### 5.2.14 Positioning Speed Override Instruction

- The positioning speed override instruction (PSO) is changing the operation speed of the axis during current positioning operation at the specific position set in the instruction. For details, refer to 3.1.10.

#### (1) Positioning speed override instruction (PSO)

Instruction	Areas available														Step	Flag			
	PMK	F	L	T	C	S	Z	D.x	R.x	constant	U	N	D	R		Error (F110)	Zero (F111)	Carry (F112)	
PSO	sl	-	-	-	-	-	-	-	-	-	○	-	-	-	-	4~7	○	-	-
	ax	○	-	○	-	-	-	○	-	-	○	-	-	○	-				
	n1	○	-	○	-	-	-	○	-	-	○	-	-	○	-				
	n2	○	-	○	-	-	-	○	-	-	○	-	-	○	-				

The diagram shows a rising edge of the COMMAND signal. The instruction format is shown as a sequence of bits: PSO, sl, ax, n1, n2.

#### [Area Setting]

Operand	Description	Setting range	Data size
sl	Slot No. of positioning module	XGB is fixed at 0	WORD
ax	Axis to give instruction	0 (axis X) or 1 (axis Y)	WORD
n1	Position to change the speed	-2,147,483,648 ~ 2,147,483,647	DINT
n2	Operation speed to change	0 ~ 100,000[pps]	DWORD

#### [Flag Set]

Flag	Description	Device number
Error	If the value of ax gets out of the range	F110

#### (a) Function

- This instruction is giving the positioning speed override instruction to XGB built-in positioning.
- The positioning speed override is executed at the axis designated as ax at the rising edge of the input condition, and if the current position reaches the position set in n1 during operation, the current operation speed is overridden to the speed set in n2.
- The positioning speed override instruction is available in the deceleration and acceleration sections and if the positioning speed override is executed during deceleration or dwell, no error code is issued, but the instruction is not executed either.

#### (b) Error

- If the value designated as ax (instruction axis) is other than 0 and 1, the error flag (F110) is set and the instruction is not executed.

## (2) Example of Use of the Instruction

## (a) Example of the Program

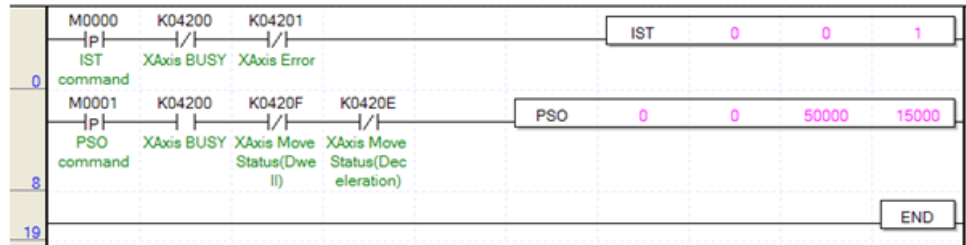

IL program

Step	Instruction	Parameter 1	Parameter 2	Parameter 3	Parameter 4
0	LOADP	M0000	IST command		
2	AND NOT	K04200	XAxis BUSY		
3	AND NOT	K04201	XAxis Error		
4	IST	0	0	1	
1	LOADP	M0001	PSO command		
10	AND	K04200	XAxis BUSY		
11	AND NOT	K0420F	XAxis Move Status(Dwell)		
12	AND NOT	K0420E	XAxis Move Status(Deceleration)		
13	PSO	0	0	50000	15000
2	END				

## (b) Operation of the Program

- If there is the rising edge of M0000 used as the indirect starting instruction signal, positioning axis X is indirectly started with operation step 1.
- If there is the rising edge of M0001 used as the instruction signal of the positioning speed override instruction during operation, operation continues by changing the operation speed to 15,000[pps] when the position of the currently operating step reaches 50,000.



### 5.2.15 Inching Starting Instruction

- The inching starting instruction (INCH) is moving to the position set in the instruction at the inching speed set in the origin/manual parameter. For details, refer to 3.1.12.

#### (1) inching starting instruction (INCH)

Instruction	Areas available														Step	Flag			
	PMK	F	L	T	C	S	Z	D.x	R.x	constant	U	N	D	R		Error (F110)	Zero (F111)	Carry (F112)	
INCH	sl	-	-	-	-	-	-	-	-	-	○	-	-	-	-	4~7	○	-	-
	ax	○	-	○	-	-	-	○	-	-	○	-	-	○	-				
	n1	○	-	○	-	-	-	○	-	-	○	-	-	○	-				

#### [Area Setting]

Operand	Description	Setting range $\cong$	Data size
sl	Slot No. of positioning module	XGB is fixed at 0	WORD
ax	Axis to give instruction	0 (axis X) or 1 (axis Y)	WORD
n1	Position to move by inching	-2,147,483,648 ~ 2,147,483,647	DINT

#### [Flag Set]

Flag	Description	Device number
Error	If the value of ax gets out of the range	F110

#### (a) Function

- This instruction is giving the inching operation instruction to XGB built-in positioning.
- It moves to the position set in n1 at the inching speed set in the positioning parameter with respect to the axis designated as ax at the rising edge of the input condition.

#### (b) Error

- If the value designated as ax (instruction axis) is other than 0 and 1, the error flag (F110) is set and the instruction is not executed.

#### (2) Example of Use of the Instruction

##### (a) Example of the Program

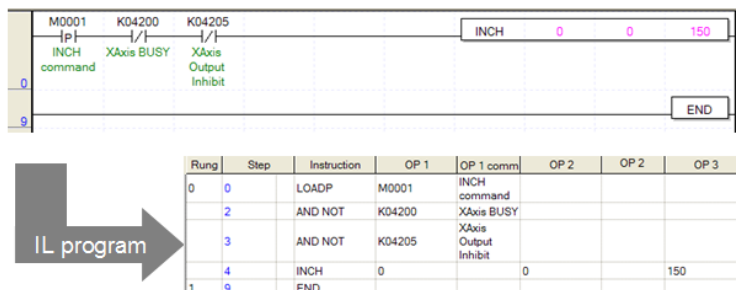

##### (b) Operation of the Program

- If there is the rising edge of M0001 used as the inching starting instruction signal, positioning axis X moves to position 150 at the inching speed set in the positioning origin/manual parameter.
- If the axis is in operation or inhibited from output during inching starting, it generates error code 401 and 402 respectively and no operation takes place.

### 5.2.16 Starting Step Number Change Instruction

- The starting step number change instruction is for changing the number of the step to be operated currently by force.

#### (1) Starting Step Number Change Instruction (SNS)

Instruction	Areas available														Step	Flag			
	PMK	F	L	T	C	S	Z	D.x	R.x	constant	U	N	D	R		Error (F110)	Zero (F111)	Carry (F112)	
SNS	sl	-	-	-	-	-	-	-	-	-	○	-	-	-	-	4~7	○	-	-
	ax	○	-	○	-	-	-	○	-	-	○	-	-	○	-				
	n1	○	-	○	-	-	-	○	-	-	○	-	-	○	-				

#### [Area Setting]

Operand	Description	Setting range	Data size
sl	Slot No. of positioning module	XGB is fixed at 0	WORD
ax	Axis to give instruction	0 (axis X) or 1 (axis Y)	WORD
n1	Step number to change	1~30(standard), 1~80(advanced)	WORD

#### [Flag Set]

Flag	Description	Device number
Error	If the value of ax gets out of the range	F110

#### (a) Function

- This instruction is giving the starting step instruction to XGB built-in positioning.
- The current step number of the axis designated as ax at the rising edge of the input condition changes into the step set in n1.
- If the corresponding axis is operating when the starting step change instruction is executed, error code 441 is issue and the instruction is not executed. If the set value of n1 gets out of the settable range, error code 442 is issued and the instruction is not executed either.

#### (b) Error

- If the value designated as ax (instruction axis) is other than 0 and 1, the error flag (F110) is set and the instruction is not executed.

#### (2) Example of Use of the Instruction

##### (a) Example of the Program

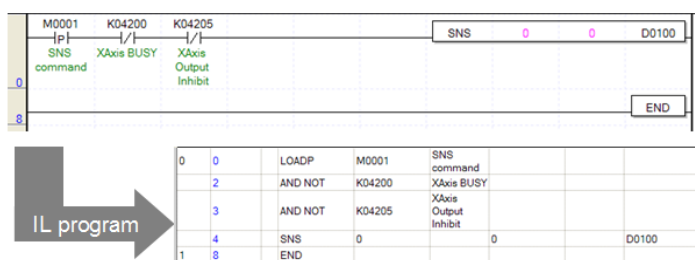

##### (b) Operation of the Program

- If there is the rising edge of M0001 used as the starting step change instruction signal, the current operation step number of positioning axis X changes into the step number set in D0100.

### 5.2.17 M Code Cancel Instruction

- M code cancel instruction (MOF) is for cancelling the M code generated during operation. For details, refer to 3.3.
- (1) M code cancel instruction (MOF)

Instruction	Areas available														Step	Flag			
	PMK	F	L	T	C	S	Z	D.x	R.x	constant	U	N	D	R		Error (F110)	Zero (F111)	Carry (F112)	
MOF	sl	-	-	-	-	-	-	-	-	-	○	-	-	-	-	4~7	○	-	-
	ax	○	-	○	-	-	-	○	-	-	○	-	-	○	-				

[Area Setting]

Operand	Description	Setting range	Data size
sl	Slot No. of positioning module	XGB is fixed at 0	WORD
ax	Axis to cancel M code	0 (axis X) or 1 (axis Y)	WORD

[Flag Set]

Flag	Description	Device number
Error	If the value of ax gets out of the range	F110

(a) Function

- This instruction is giving the instruction of cancelling the M code to XGB built-in positioning.
- The M code On signal (axis X: K4203, axis Y: K4303 bit) of the axis designated as ax at the rising edge of the input condition and M code number (axis X : K428, axis Y:K438 word) are simultaneously cancelled.

(b) Error

- If the value designated as ax (instruction axis) is other than 0 and 1, the error flag (F110) is set and the instruction is not executed.

(2) Example of Use of the Instruction

(a) Example of the Program

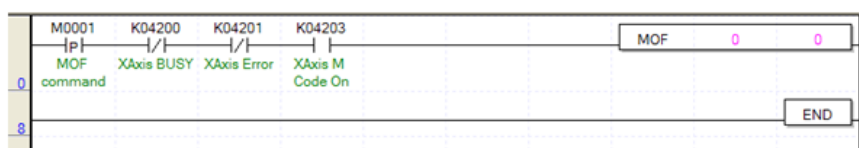

IL program →

0	0	LOADP	M0001	MOF command	
2		AND NOT	K04200	XAxis BUSY	
3		AND NOT	K04201	XAxis Error	
4		AND	K04203	XAxis M Code On	
5		MOF	0		0
1	8	END			

(b) Operation of the Program

- If there is the rising edge of M0001 used as the M code cancel instruction signal and if there is an M code in positioning axis X, the M code On signal and M code number are cancelled.

### 5.2.18 Current Position Preset Instruction

- The current position preset instruction (PRS instruction) is for changing the current position by force.

#### (1) Current Position Preset Instruction (PRS)

Instruction	Areas available														Step	Flag			
	PMK	F	L	T	C	S	Z	D.x	R.x	constant	U	N	D	R		Error (F110)	Zero (F111)	Carry (F112)	
PRS	sl	-	-	-	-	-	-	-	-	-	○	-	-	-	-	4~7	○	-	-
	ax	○	-	○	-	-	-	○	-	-	○	-	-	○	-				
	n1	○	-	○	-	-	-	○	-	-	○	-	-	○	-				

#### [Area Setting]

Operand	Description	Setting range	Data size
sl	Slot No. of positioning module	XGB is fixed at 0	WORD
ax	Axis to give instruction	0 (axis X) or 1 (axis Y)	WORD
n1	Current position value to change	-2,147,483,648 ~ 2,147,483,647	DINT

#### [Flag Set]

Flag	Description	Device number
Error	If the value of ax gets out of the range	F110

#### (a) Function

- This instruction is giving the instruction of changing the current position to XGB built-in positioning.
- The current position of the axis designated as ax at the rising edge of the input condition is changed to the position set in n1 of the instruction by force.
- If the origin is not fixed, the origin fixed status (axis X:K4202, axis Y:K4304) turns On and the origin is fixed.
- If the current position preset instruction is executed, and if the axis is currently operating, error code 451 is issued and the instruction is not executed.

#### (b) Error

- If the value designated as ax (instruction axis) is other than 0 and 1, the error flag (F110) is set and the instruction is not executed.

#### (2) Example of Use of the Instruction

##### (a) Example of the Program

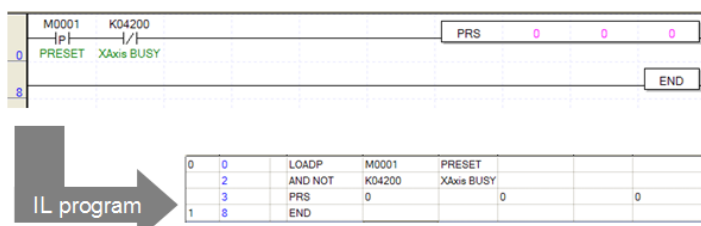

##### (b) Operation of the Program

- If there is the rising edge of M0001 used as the current position preset, the current position of the positioning axis X changes into 0, which has been set in the instruction, and the origin determining bit turns On.

### 5.2.19 Emergency Stop Instruction

- The emergency stop instruction is immediately stopping the current positioning operation and the output. For details, refer to 3.1.11.

#### (1) Emergency Stop Instruction (EMG)

Instruction	Areas available														Step	Flag			
	PMK	F	L	T	C	S	Z	D.x	R.x	constant	U	N	D	R		Error (F110)	Zero (F111)	Carry (F112)	
EMG	sl	-	-	-	-	-	-	-	-	-	○	-	-	-	-	4~7	○	-	-
	ax	○	-	○	-	-	-	○	-	-	○	-	-	○	-				

#### [Area Setting]

Operand	Description	Setting range	Data size
sl	Slot No. of positioning module	XGB is fixed at 0	WORD
ax	Axis to give instruction	0 (axis X) or 1 (axis Y)	WORD

#### [Flag Set]

Flag	Description	Device number
Error	If the value of ax gets out of the range	F110

#### (a) Function

- This is for giving the emergency stop instruction to XGB built-in positioning.
- With respect to the positioning of the axis designated as ax at the rising edge of the input condition, the output immediately stops, the output stop status flag (axis X : K4205, axis Y:K4305) turns On, and error code 481 is issued.
- If the emergency stop instruction is executed, output is inhibited and the origin gets undecided, so in order to resume operation, set the origin return or floating origin or preset the current position to decide the origin.

#### (b) Error

- If the value designated as ax (instruction axis) is other than 0 and 1, the error flag (F110) is set and the instruction is not executed.

#### (2) Example of Use of the Instruction

##### (a) Example of the Program

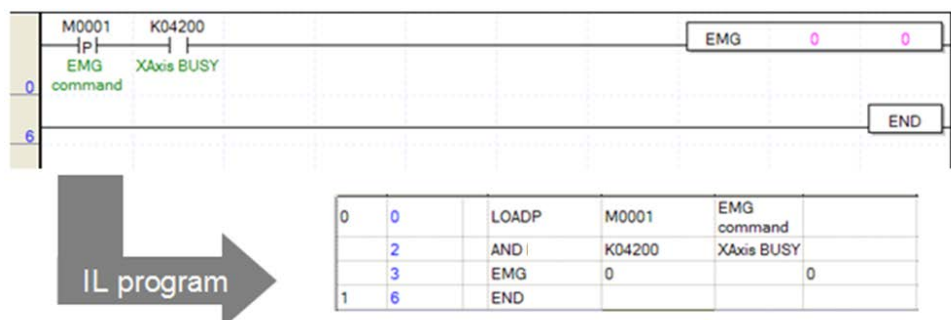

##### (b) Operation of the Program

- If there is the rising edge of M0001 used as the emergency stop instruction signal, the positioning axis X immediately stops the current operation, issues error code 481 and inhibits output.

### 5.2.20 Error Reset, Output Inhibition, Inhibition Termination

- The error reset instruction is resetting the current error and terminating the output inhibition.

#### (1) Error Reset Instruction (CLR)

Instruction	Areas available														Step	Flag					
	PMK	F	L	T	C	S	Z	D.x	R.x	Constant	U	N	D	R		Error (F110)	Zero (F111)	Carry (F112)			
CLR	sl	-	-	-	-	-	-	-	-	-	○	-	-	-	4~7	○	-	-			
	ax	○	-	○	-	-	-	○	-	-	○	-	-	○					-	-	-
	n1	○	-	○	-	-	-	○	-	-	○	-	-	○					-	-	-

#### [Area Setting]

Operand	Description	Setting range	Data size
sl	Slot No. of positioning module	XGB is fixed at 0	WORD
ax	Axis to give instruction	0 (axis X) or 1 (axis Y)	WORD
n1	Whether output inhibition is terminated	0 ~ 65,535	WORD

#### [Flag Set]

Flag	Description	Device number
Error	If the value of ax gets out of the range	F110

#### (a) Function

- This instruction is giving the error reset instruction to XGB built-in positioning.
- At the rising edge of the input condition, the error code generated in the axis designated as ax is cancelled, and if the value set in n1 is 0, only the error code is cancelled, with the output inhibition maintained. If the value set in n1 is other than 0, the output inhibition is also cancelled.

#### (b) Error

- If the value designated as ax (instruction axis) is other than 0 and 1, the error flag (F110) is set and the instruction is not executed.

#### (2) Example of Use of the Instruction

##### (a) Example of the Program

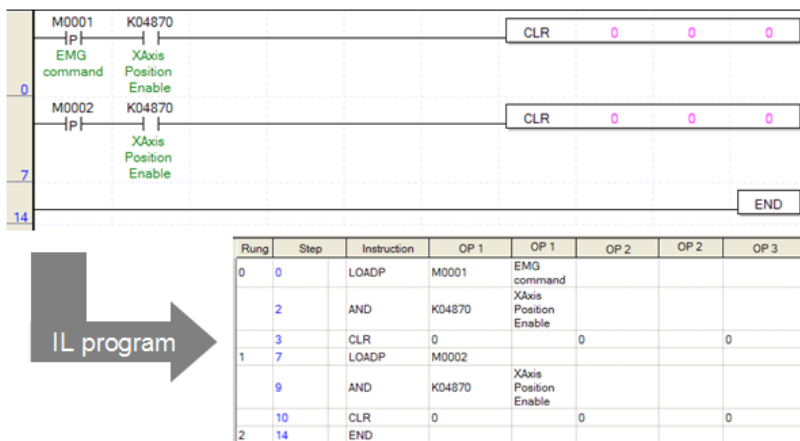

(b) Operation of the Program

- If the error and output inhibition are simultaneously generated due to the emergency stop, when there is the rising edge of M0001 used as the error cancel instruction signal, only the error code of axis X is cancelled but the output inhibition is not cancelled.
- If there is the rising edge of M0002 used as the error termination/output inhibition termination instruction signal, the error code of axis X and output inhibition are cancelled together.

### 5.2.21 Parameter/Operation Data Save

- The parameter save instruction (WRT) is permanently preserving the operation data of positioning area K changed during operation in the XGB built-in flash memory. For the relations between positioning area K and the positioning parameter, refer to 3.2.2.

#### (1) Parameter Save (WRT)

Instruction	Areas available														Step	Flag					
	PMK	F	L	T	C	S	Z	D.x	R.x	constant	U	N	D	R		Error (F110)	Zero (F111)	Carry (F112)			
WRT	sl	-	-	-	-	-	-	-	-	-	○	-	-	-	4~7	○	-	-			
	ax	○	-	○	-	-	-	○	-	-	○	-	-	○					-	-	-
	n1	○	-	○	-	-	-	○	-	-	○	-	-	○					-	-	-

#### [Area Setting]

Operand	Description	Setting range	Data size
sl	Slot No. of positioning module	XGB is fixed at 0	WORD
ax	Not used in XGB	0 ~ 1(Dummy Operand)	WORD
n1	Set the parameter to save	0 ~ 2	WORD

#### [Flag Set]

Flag	Description	Device number
Error	If the value of ax gets out of the range	F110

#### (a) Function

- The instruction is for permanently preserving the operation data of positioning area K in the XGB built-in flash memory.
- The operation data of positioning area K are permanently preserved in the XGB built-in flash memory according to the setting of n1 at the rising edge as follows.

Set value	0	1	2
Area k to be permanently preserved	Positioning data	High speed counter data	PID control function data

- If n1 has been set at 0, the current operation data of area K of axis X and axis Y for positioning are permanently preserved as the positioning parameter. If set at 1, the data of area K of all the channels of the high speed counter are permanently preserved as the positioning parameter. If set at 2, the data set in area K of 16 loop of the built-in PID are permanently preserved as the PID parameter.
- Although the value set as ax is the operand that does not affect the execution of WRT instruction, if it gets out of the setting range, instruction execution error flag (F110) turns On and the instruction is not executed.

#### (b) Error

- If the value designated as ax (instruction axis) is other than 0 and 1, the error flag (F110) is set and the instruction is not executed.



## (2) Example of Use of the Instruction

## (a) Example of the Program

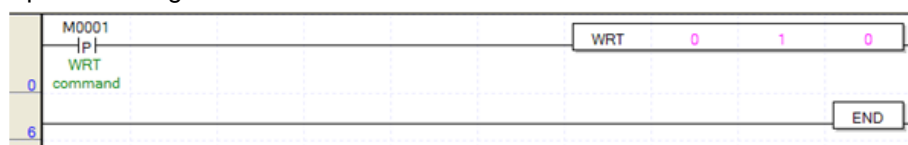

0	0	LOADP	M0001	WRT command			
	2	WRT	0		1		0
1	6	END					

## (b) Operation of the Program

- If there is the rising edge of M0001 used as the parameter save instruction signal, the operation data of area K of positioning axis X and axis Y are permanently preserved as the positioning parameter of XGB built-in flash memory.

- If WRT instruction is executed, the previously saved positioning parameter is deleted and the parameter is changed to the operation data of the current area K.
- Be careful that if WRT instruction is executed, the scan time of the scan where the instruction has been executed because the previous positioning parameter of the flash memory is deleted and the operation data of area K is written.

### 5.2.22 Pulse Width Modulation

- Pulse Width Modulation is to operate On/Off output in designated Off duty rate and Output cycle.

#### (1) Pulse width Modulation (PWM)

Instruction	Areas available														Step	Flag					
	PMK	F	L	T	C	S	Z	D.x	R.x	constant	U	N	D	R		Error (F110)	Zero (F111)	Carry (F112)			
WRT	sl	-	-	-	-	-	-	-	-	-	○	-	-	-	4~7	○	-	-			
	ax	○	-	○	-	-	-	○	-	-	○	-	-	○					-	-	-
	n1	○	-	○	-	-	-	○	-	-	○	-	-	○					-	-	-
	n2	○	-	○	-	-	-	○	-	-	○	-	-	○					-	-	-

PWM		COMMAND	
-----	---	---------	--

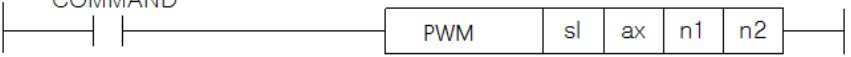
#### [Area Setting]

Operand	Description	Setting range	Data size
sl	Slot No. of positioning module	XGB is fixed at 0	WORD
ax	Axis to give instruction	0 (axis X) or 1 (axis Y)	WORD
n1	Output Cycle	1~20,000(ms)	WORD
n2	Off duty rate	0~100(%)	WORD

#### [Flag Set]

Flag	Description	Device number
Error	If the value of ax gets out of the range	F110

#### (a) Function

- This instruction is for PWM output.
- While the input condition is On state, XGB positioning outputs pulse train in designated cycle time in n1 and designated Off duty rate in n2 at designated axis in ax
- During PWM output, current address don't change. Constant speed bit(X axis: K0420D, Y axis: K0430S) and Operation bit(X axis: K04200 Y axis: K4300) set On.

#### (b) Error

- If the value designated as ax (instruction axis) is other than 0 and 1, the error flag (F110) is set and the instruction is not executed.

#### Remark

- If PWM instruction is executed, other instruction do not operate. And upper/lower limit does not work
- If PWM instruction is executed, STP, EMG instruction doesn't operate. To stop output, Off the Start-up contact
- If output cycle is changed, when operating APM\_PWM, it cannot be applied.

## (2) Example of Use of the Instruction

## (a) Example of the Program

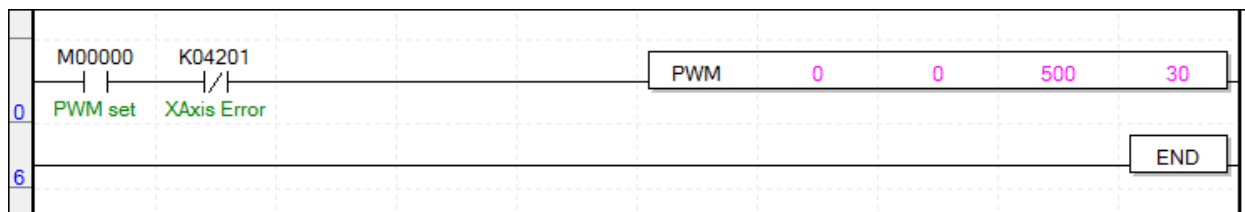

## (b) Used Device

Device	설 명
M00000	PWM output reference signal
K04201	X-axis error state

## (c) Operation of the Program

- While M00000 is On which is used as output reference signal, PWM is operated.  
(At this time, the X-axis is in operation or errorstatus, the instruction will not be executed.)
- If PWM executed, designated output cycle(500ms for this picture) and designated Off duty rate(30% for this picture)

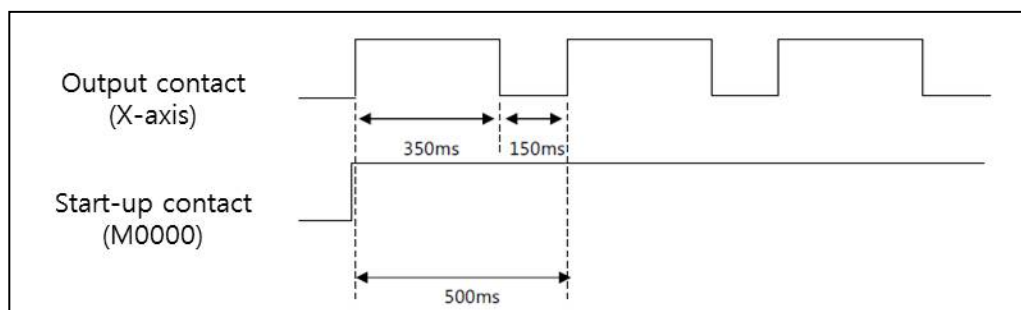

## Chapter 6 Positioning Monitoring Package

### 6.1 Introduction to Positioning Monitoring Package

You can monitor the status of XGB PLC built-in positioning and carry out test operation without the program by changing the parameters and operation data if you use the XGB monitoring package.

#### 6.1.1 Introduction of Positioning Monitoring Package

- You can easily and conveniently monitor the current positioning operation or change the parameter or operation data by using the following positioning monitoring package with XGB PLC connected to XG5000.
- If you use the positioning monitoring package, you can easily carry out test operation without the program, adjust the parameter and operation data, and permanently save it in PLC after the adjustment.
- This chapter describes how to run the XGB positioning monitoring package.

##### (1) Opening the Monitoring Package

- Select 'Monitoring' → 'Special Module Monitoring' with XGB PLC connected to XG5000, the special module monitoring display is invoked as follows.  
(If XGB is not connected to XG5000, 'Special Module Monitoring' is inactivated in the 'Monitoring' menu. Thus make sure that XGB is connected to XG5000 before using positioning monitoring.)

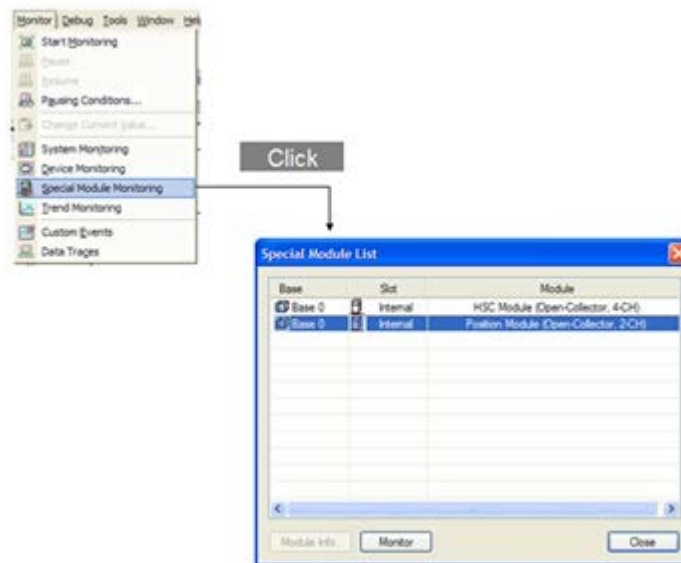

- When you want to carry out the positioning monitoring package, double click on the positioning module or select the positioning module, and then click on the 'Monitoring' button at the bottom. And the positioning monitoring package is started as follows.

## Chapter 6 Positioning Monitoring Package

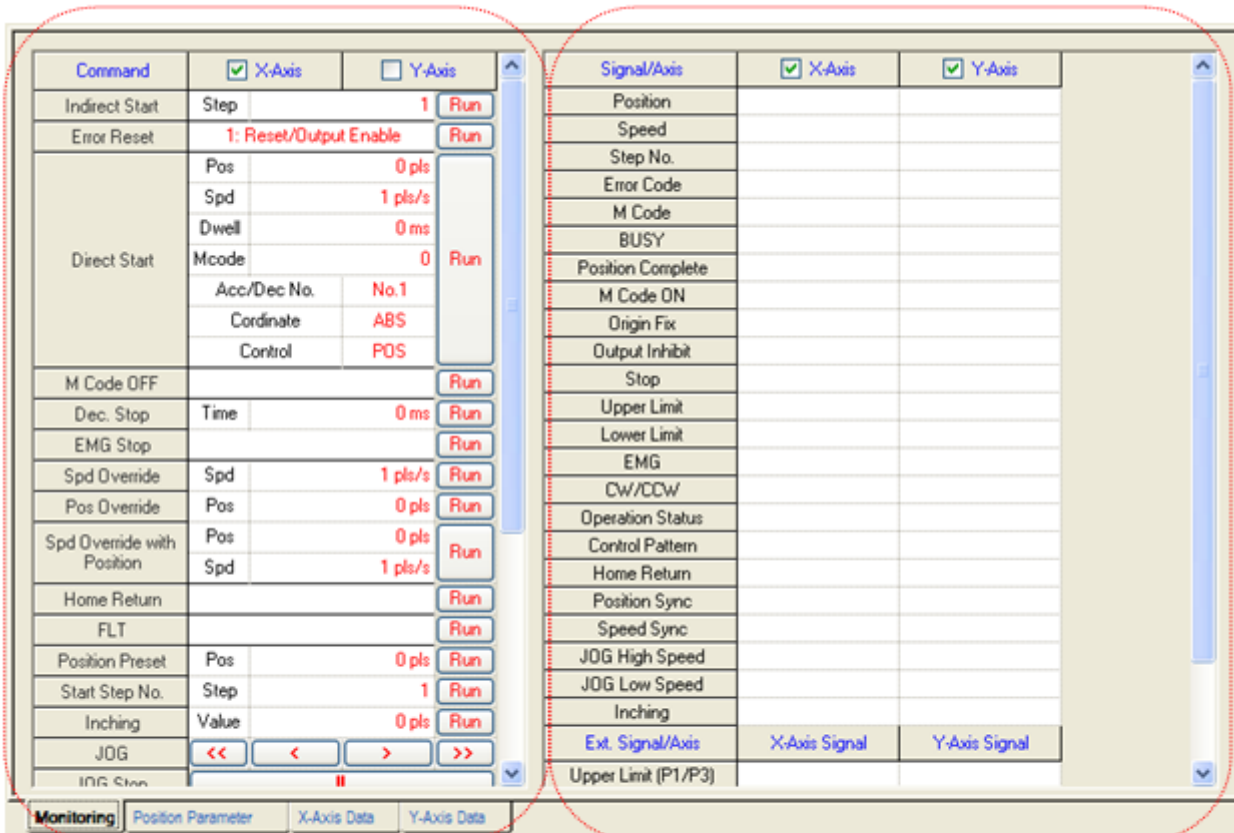

Position command window
Status monitoring window

- The menu and function of the positioning monitoring package are as follows.

Items	Functions	Remark
<b>Monitoring</b>	Monitors the positioning of the axis or gives commands.	
<b>Position Parameter</b>	Checks and modifies the positioning parameter of each axis.	
<b>X-Axis Data</b>	Checks and modifies the operation data of axis X.	
<b>Y-Axis Data</b>	Checks and modifies the operation data of axis Y.	
Start Monitor	Carried out positioning monitoring.	
Stop Monitor	Stops positioning monitoring.	
Write PLC	Permanently saves the changed parameter and operation data in PLC.	WRT function
Save Project	Saves the changed parameter and operation data in XG5000 project.	

- For details of each menu, refer to 6.2.

## 6.2 Menus and Functions of Positioning Monitoring

The following is the function and use of the menus of the XGB monitoring package.

### 6.2.1 Monitoring and Command

- The positioning monitoring package consists of the command window for positioning test operation and positioning monitoring window as shown above.
- If you click on the 'Start Monitor' button at the left bottom of the package, the monitoring and command function is activated to make various commands and current status monitoring functions available.
- If you start the command on the left, the corresponding functions are activated without the program and the status is displayed on the monitoring window on the right.

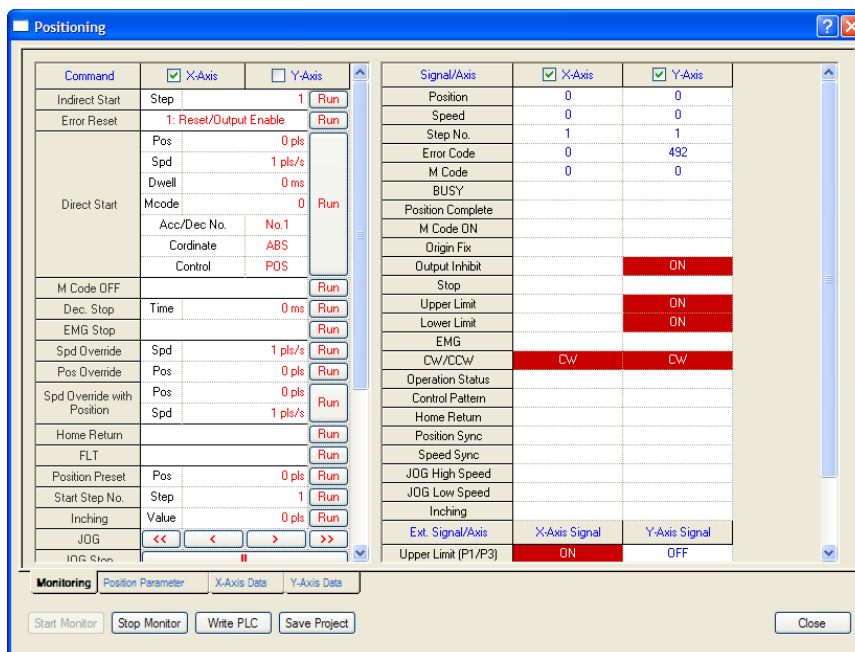

#### (1) Positioning Command

- The commands available in the positioning monitoring package are as follows.
- To execute an command, enter the setting of the command, and click on the 'Run' button (「<<」, 「<」, 「||」, 「>」, 「>>」 during jog operation).

Item	Description	Command	Remark
Indirect start	Direct start with the operation step set in the monitoring window	IST APM_IST	5.2.4 5.3.5
Error reset	Resets the error code and output inhibition in case of an error	CLR APM_RST	5.2.20 5.3.21
Direct start	Directly starts with the position, speed, dwell, M code, acc./dec. number, coordinates and control method set in the monitoring window	DST APM_DST	5.2.3 5.3.4
M code OFF	Cancels the M code On signal and M code number	MOF APM_MOF	5.2.17 5.3.18
Dec. stop	Carries out deceleration stop in the set deceleration time	STP APM_STP	5.2.9 5.3.10
EMG stop	Stops the operation of the axis and inhibits pulse output	EMG APM_EMG	5.2.19 5.3.20

## Chapter 6 Positioning Monitoring Package Positioning Monitoring Package

Item	Description	Command	Remark
Spd override	Overrides the speed at the set speed value	SOR APM_SOR	5.2.13 5.3.14
Pos override	Overrides the position at the set position value	POR APM_POR	5.2.12 5.3.13
Spd override with position	Changes the operation speed at the speed value set in the set position	PSO APM_PSO.	5.2.14 5.3.15
Home return	Conducts home return as the home return method set in the positioning parameter	ORG APM_ORG	5.2.1 5.3.2
FLT	Sets the current position as the fixed home	FLT APM_FLT	5.2.2 5.3.3
Position preset	Presets the current position with the set value	PRS APM_PRS	5.2.18 5.3.19
Start step No.	Changes the start step with the set step	SNS APM_SNS	5.2.16 5.3.17
Inching	Conducts inching operation to the set position (inching amount) at the inching speed set in the positioning parameter	INCH APM_INC	5.2.15 5.3.16
Jog	Conducts jog operation at the jog speed set in the parameter	-	
			
	Reverse high speed    Reverse low speed    Jog stop    Normal low speed    Normal high speed		
Spd position conversion	Changes from speed control to position control	VTP APM_VTP	5.2.7 5.3.8
Position spd conversion	Changes from position control to speed control	PTV APM_PTV	5.2.8 5.3.9
Spd synchronous operation	Speed synchronous operation at the set main axis, speed ration and delay time	SSS APM_SSS	5.2.11 5.3.12
Position synchronous operation	Speed synchronous operation at the set main axis, step and position	SSP APM_SSP	5.2.10 5.3.11
Simultaneous start	Simultaneous start with the operation step set for each axis	SST APM_SST	5.2.6 5.3.7
Straight interpolation operation	Straight interpolation operation for axes X and Y with the set operation step	LIN APM_LIN	5.2.5 5.3.6

**Remark**

- Note that the positioning command through the XGB positioning monitoring package is executed regardless of the operation mode of PLC.
- If the PLC operation mode is Run mode, the positioning command is executed in the positioning monitoring package, and if a different command is executed in the instruction of the program, XGB PLC executes them both. Therefore, in such a case, it might operate differently from the intent of the user or an error might occur. Note that if you use the positioning monitoring package, positioning by the instruction in the program is not executed.

## (2) Positioning Monitoring Window

- The monitoring window on the right of the monitoring package displays the current status according to the positioning command.
- The information displayed in the positioning monitoring window is as follows.

Item	Displays	Related flag		Remark
		Axis X	Axis Y	
Current position	Current position of each axis	K422	K432	DINT
Current speed	Current speed of each axis	K424	K434	DINT
Step No.	Currently operating step of each axis	K426	K436	WORD
Error code	Error code in case of an error of the axis	K427	K437	WORD
M code	M code of the currently operating step	K428	K438	WORD
Busy	Whether the axis is operating	K4200	K4300	BIT
Positioning complete	Whether the positioning has been completed for the axis	K4202	K4302	BIT
M code On	M code On/Off of the currently operating step	K4203	K4303	BIT
Origin fix	Whether the origin has been fixed	K4204	K4304	BIT
Output inhibit	Whether output is inhibited	K4205	K4305	BIT
Upper limit detection	Whether the upper limit is detected	K4208	K4308	BIT
Lower limit detection	Whether the lower limit is detected	K4209	K4309	BIT
EMG stop	Emergency stop	K420A	K430A	BIT
Normal/reverse rotation	Normal and reverse rotation	K420B	K430B	BIT
Operation status	The operation status of each axis (acc., dec., constant speed, and dwell)	K420C~ K420F	K430C~ K430F	BIT
Control pattern	Operation control pattern of each axis (position, speed, interpolation)	K4210~ K4212	K4310~ K4312	BIT
Home return	Whether home return is being conducted	K4215	K4315	BIT
Position Sync	Whether position synchronization is being conducted	K4216	K4316	BIT
Speed Sync	Whether position synchronous operation is being conducted	K4217	K4317	BIT
Jog high speed	Whether jog high speed operation is being conducted	K4219	K4319	BIT
Jog low speed	Whether jog low speed operation is being conducted	K4218	K4318	BIT
Inching	Whether inching operation is being conducted	K421A	K431A	BIT



## (3) Positioning External Input Signal Monitoring

- The external signal monitoring at the bottom of the monitoring window displays the status of the external input contact point, which is the fixed input contact point for the axes as follows.

Item	Displays	Type	Contact No.		Remark
			Axis X	Axis Y	
Upper limit signal	External upper limit signal status of the axes	XBM	P00001	P00003	
Lower limit signal	External lower limit signal status of the axes	XBM	P00000	P00002	
Approximate origin signal	Approximate origin signal status of the axes	XBM	P00004	P00006	
Origin signal	Origin signal status of the axes	XBM	P00005	P00007	

## 6.3 Parameter/Operation Data Setting Using Monitoring Package

You can change the positioning parameter and operation data of XGB PLC and do test operation by using the XGB monitoring package.

### 6.3.1 Changing the Position Parameter

#### (1) How to Change the Parameter

- You can change the position parameter by using the position monitoring package. Note that the change of the parameter is applied when the next operation is started after the currently operating step ends.
- If you select 'Position Parameter' tab in the positioning monitoring package, the window appears where you can change the positioning basic parameter and the origin/manual parameter and the parameter saved in XG5000 is displayed as well.

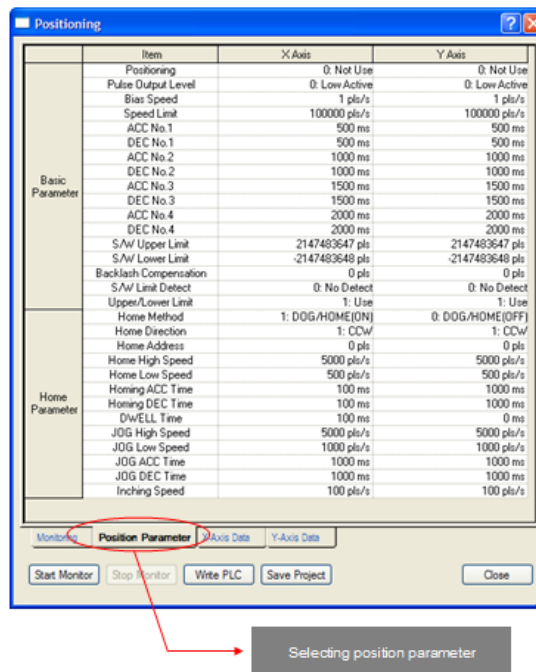

- To change the parameter, first of all, change the parameter value to change, and select 'Write PLC'. Then the changed parameter is transferred to PLC, the position parameter saved in PLC is changed, and the parameter and operation data that have been changed are applied when the next operation step is started.

#### Remark

- If you execute 'Write PLC,' the position parameter set in the positioning monitoring package and the operation data of each axis are all transferred to XGB.
- The parameter and operation data displayed when the positioning monitoring package is executed are not the data read from XGB but the parameter and operation data currently saved in XG5000. Therefore if you change the parameter or operation data in the positioning monitoring package and save them in the XGB PLC, be sure to press the 'Save Project' button to save them in the XG5000 project. Otherwise the settings of XG5000 might be different from XGB.

### 6.3.2 Change of Position Operation Data

#### (1) How to Change the Position Operation Data

- You can change the operation data of each axis during operation by using the positioning monitoring package. Note that the change of the operation data is applied when the next operation is started after the currently operating step ends.
- If you select the 'axis X data' or 'axis Y data' tabs in the positioning monitoring package, the window is invoked where you can set the operation data of each axis as follows along with the operation data saved in XG5000.

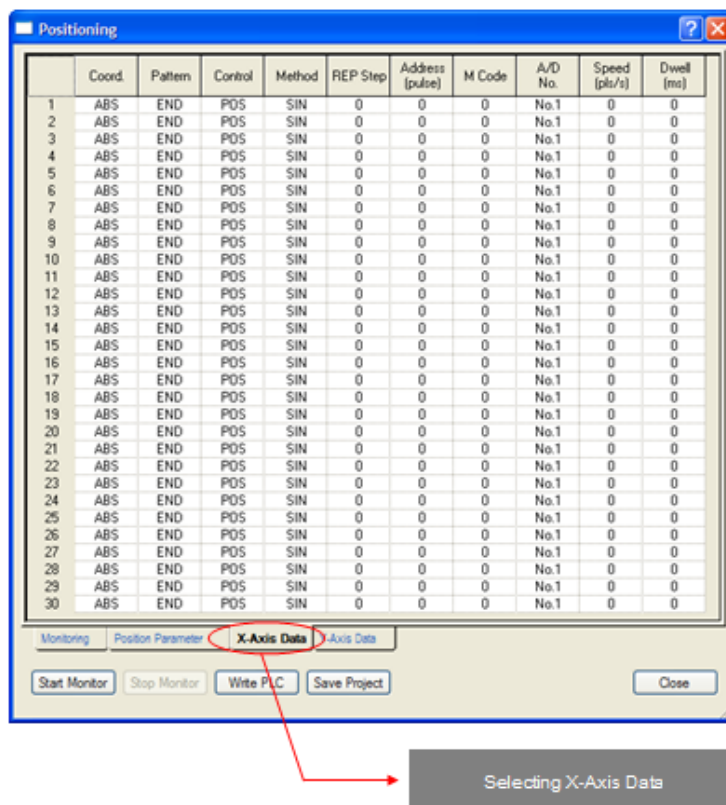

- To change the operation data, first of all, change the operation data value to change, and select 'Write PLC'. Then the changed operation data is transferred to PLC, the operation data saved in PLC is changed, and the parameter and operation data that have been changed are applied when the next operation step is started

#### Remark

- If you execute 'Write PLC,' the position parameter set in the positioning monitoring package and the operation data of each axis are all transferred to XGB.
- The parameter and operation data displayed when the positioning monitoring package is executed are not the data read from XGB but the parameter and operation data currently saved in XG5000. Therefore if you change the parameter or operation data in the positioning monitoring package and save them in the XGB PLC, be sure to press the 'Save Project' button to save them in the XG5000 project. Otherwise the settings of XG5000 might be different from XGB.
- For details, refer to 3.2. and 3.3.

## Chapter 7 Program Examples of Positioning

This chapter describes the program examples of the instructions of XGB positioning function.

### 7.1 System Composition and Setting of Input and Output

- This section describes the setting of the positioning system and the input and output signals for the program example of XGB positioning. If there is no separate description, all the example programs addressed in Chapter 7 were made according to the settings of the input and output signals described in this chapter.

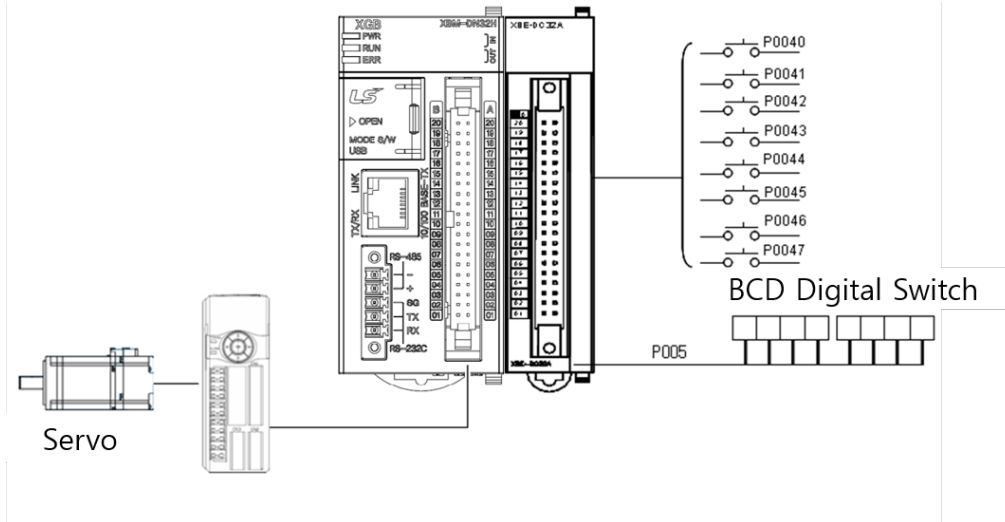

#### Remark

- Be sure to set the basic parameter positioning as '1:Use' when you use the positioning function.

Positioning		X Axis	Y Axis
Basic Parameter	Positioning	1: Use	0: Not Use
	Pulse Output Level	0: Low Active	0: Low Active
	Bias Speed	1 pls/s	1 pls/s
	Speed Limit	100000 pls/s	100000 pls/s
	ACC No.1	500 ms	500 ms
	DEC No.1	500 ms	500 ms
	ACC No.2	1000 ms	1000 ms
	DEC No.2	1000 ms	1000 ms
	ACC No.3	1500 ms	1500 ms
	DEC No.3	1500 ms	1500 ms

## 7.2 Program Examples

### 7.2.1 Floating Origin Setting/Single Operation

(1) Ladder program

- The example program of the single operation after the floating origin setting by using the XGB positioning function is as follows.

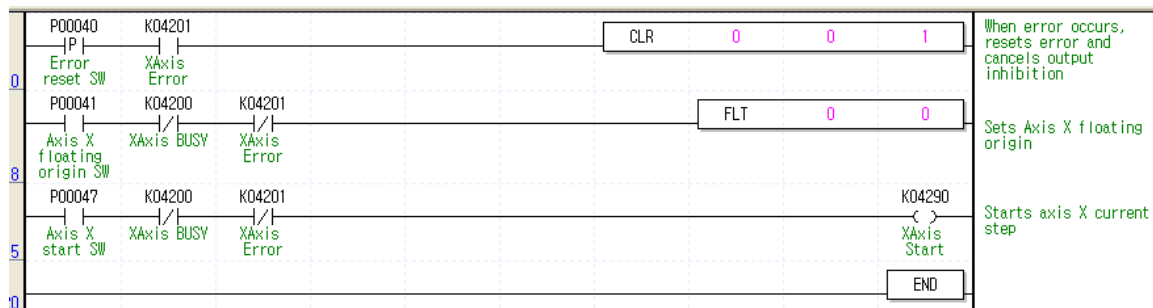

(2) Devices Used

Device	Description
P0040	Axis X error reset, output inhibition cancel switch
P0041	Axis X axis X floating origin switch
P0047	Start switch of axis X
K4200	Signal during axis X operation
K4201	Error signal of axis X
K4290	Axis X start

(3) Operation Data Setting

Step No.	coordinates	Control pattern	Operation pattern	Operation type	Repeat step	Target position [pulse]	M code	Acc./Dec. No.	Operation speed [pls/s]	Dwell time [ms]
1	Absolute	Position control	End	Single	0	10,000	0	1	1000	100
2	Absolute	Position control	End	Single	0	20,000	0	1	1500	100
3	Absolute	Position control	End	Single	0	30,000	0	1	2000	100

(4) Operation Sequence

- P0041(floating origin) switch On : set as the floating origin at the current position
- 3 times of P0047 (start) switch On : 3 times of single operation (steps 1~3). If it is operating now, the start instruction is not executed.

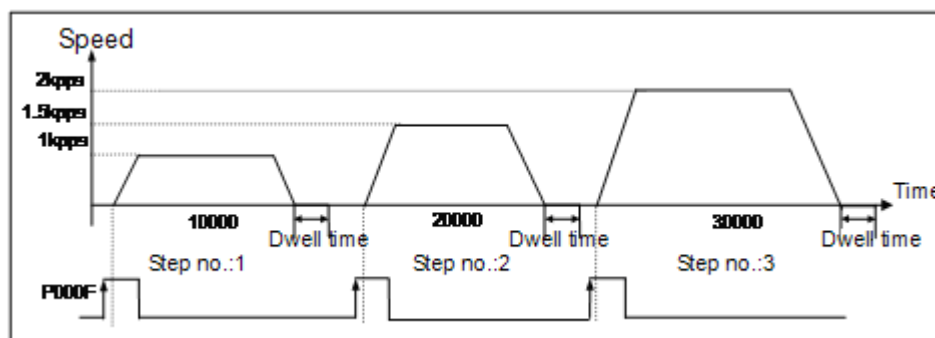

## 7.2.2 Straight Interpolation Operation

(1) Ladder program

• The example program of the straight interpolation operation after the floating origin is set is as follows

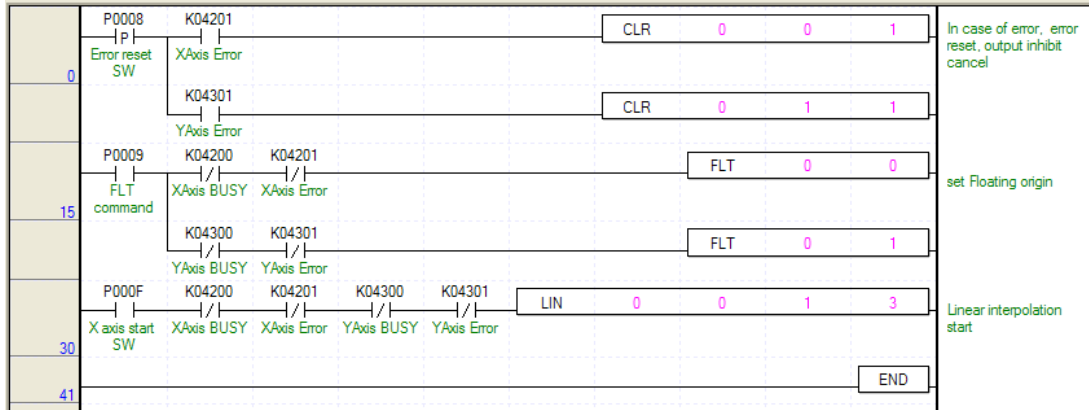

(2) Devices Used

Device	Description
P0008	Axis X error reset, output inhibition cancel switch
P0009	floating origin switch
P000F	Straight interpolation start switch
K4200	Signal during operation of axis X
K4201	Signal of axis X error
K4300	Signal during operation of axis Y
K4301	Signal of axis Y error

(3) Operation Data Setting

Axis	Step No.	coordinates	Control pattern	Operation pattern	Operation type	Repeat step	Target position [pulse]	M code	Acc./Dec. No.	Operation speed [pls/s]	Dwell time [ms]
X	1	Absolute	Position control	End	Single	0	10,000	0	1	1000	100
Y	1	Absolute	Position control	End	Single	0	5,000	0	1	1000	100

## (4) Operation Sequence

- P0009 (floating origin) switch On : set as the floating origin at the current position.
- P000E (straight interpolation start) switch On : the straight interpolation start of axes X-Y is started.

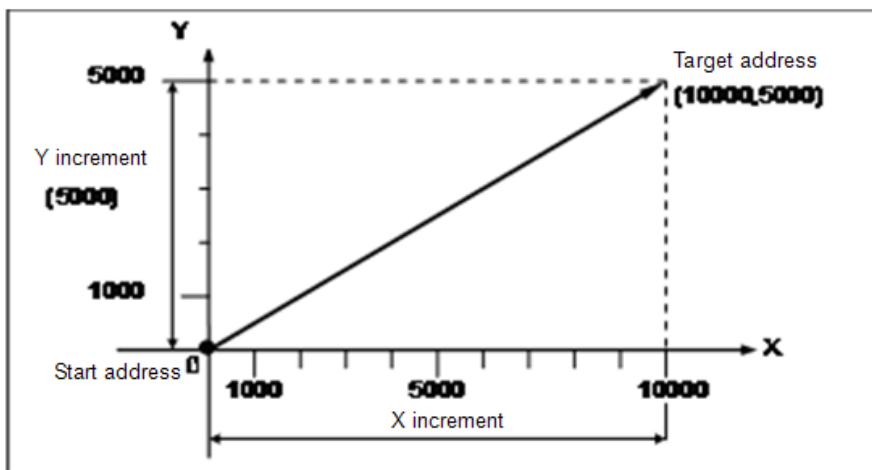

### 7.2.3 Deceleration Stop

(1) Ladder program

• The example program of deceleration stop during operation is as follows.

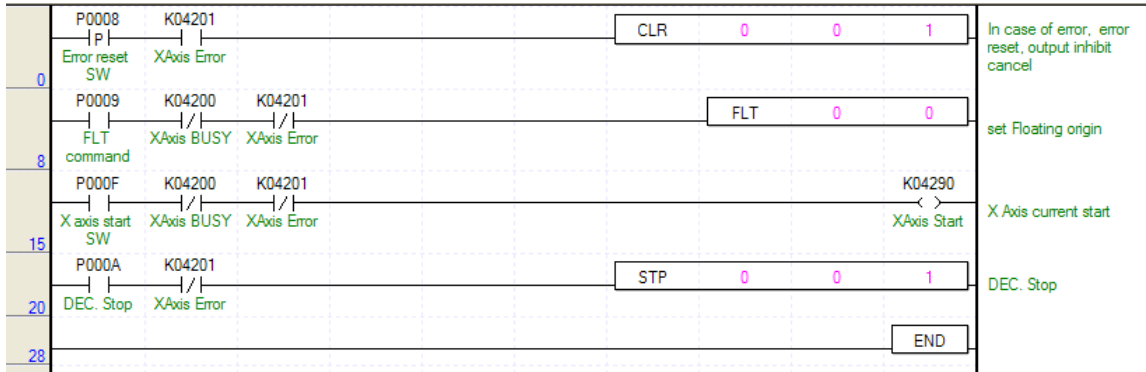

(2) Devices Used

Device	Description
P0008	Axis X error reset, output inhibition cancel switch
P0009	axis X floating origin switch
P000A	axis X deceleration stop switch
P000F	axis X start switch
K4200	Signal during axis X operation
K4201	Error signal of axis X

(3) Operation Data Setting

Step No.	coordinates	Control pattern	Operation pattern	Operation type	Repeat step	Target position [pulse]	M code	Acc./Dec. No.	Operation speed [pls/s]	Dwell time [ms]
1	Absolute	Position control	End	Single	0	10,000	0	1	1000	100

(4) Operation Sequence

- P0009 (floating origin) switch On : set as the floating origin at the current position.
- P000F (start) switch On : indirect start of axis X is started.
- P000A (deceleration stop) switch On : Since the deceleration time is not 0 when the deceleration stop instruction is given, it does deceleration stop for the deceleration time (100ms) of the currently operating step.



### 7.2.4 Setting of Operation Step/Single Operation

(1) Ladder program

• The example program of conducting the single operation by setting the operation step is as follows.

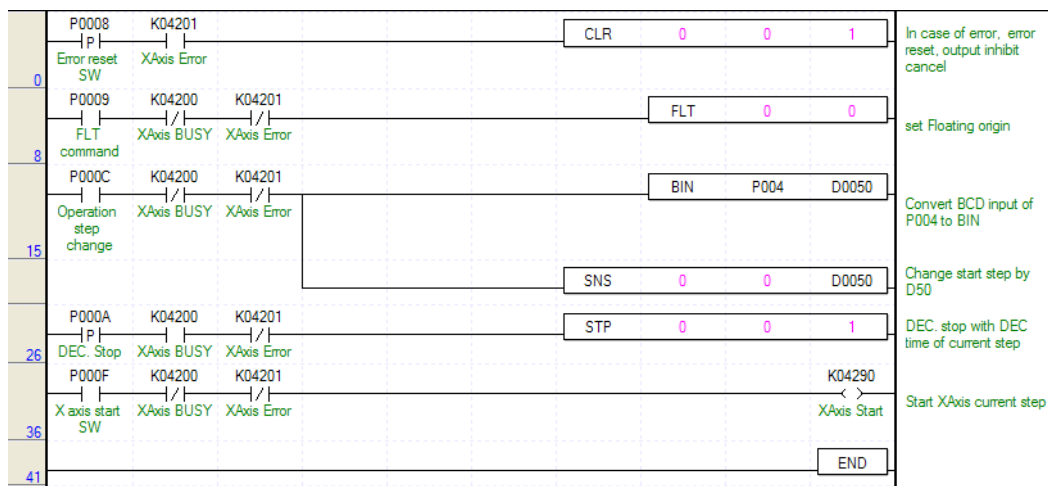

(2) Devices Used

Device	Description
P0008	Error reset, output inhibition cancel switch
P0009	Floating origin switch
P000C	Operation step change switch
P000F	axis X start switch
K4200	Signal during axis X operation
K4201	Error signal of axis X

(3) Operation Data Setting

Step No.	coordinates	Control pattern	Operation pattern	Operation type	Repeat step	Target position [pulse]	M code	Acc./Dec. No.	Operation speed [pls/s]	Dwell time [ms]
1	Absolute	Position control	End	Single	0	10,000	0	1	1,000	100
2	Absolute	Position control	End	Single	0	20,000	0	1	1,500	100
3	Absolute	Position control	End	Single	0	30,000	0	1	2,000	100
10	Absolute	Position control	End	Single	0	50,000	0	1	1,000	100
11	Absolute	Position control	End	Single	0	60,000	0	1	1,500	100
12	Absolute	Position control	End	Single	0	70,000	0	1	2,000	100

(4) Operation Sequence

- P0009(floating origin) switch On : set as the floating origin at the current position.
- BCD/SNS\_STEP switch input: enters the operation step to change in P004(enters 10 in this example).
- P000C(operation step change) switch On : the currently operating step changes into 10.
- P000F(axis X start) On : indirect start is conducted with the changed step (10).

## 7.2.5 Setting of Operation Step/Speed Control

### (1) Ladder program

- The program example of conducting speed control by setting the operation step is as follows.

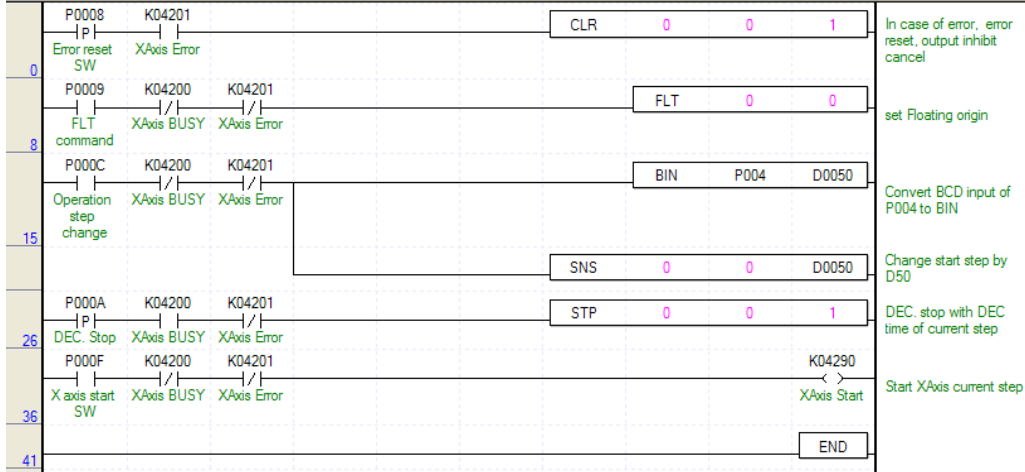

### (2) Devices Used

Device	Description
P0008	Error reset, output inhibition cancel switch
P0009	floating origin switch
P000C	Operation step changing switch
P000F	axis X start switch
P000A	Deceleration stop switch of axis X
K4200	Signal during axis X operation
K4201	Error signal of axis X

### (3) Operation Data Setting

Step No.	coordinates	Control pattern	Operation pattern	Operation type	Repeat step	Target position [pulse]	M code	Acc./Dec. No.	Operation speed [pls/s]	Dwell time [ms]
1	Absolute	Position control	End	Single	0	10,000	0	1	1,000	100
2	Absolute	Position control	End	Single	0	20,000	0	1	1,500	100
3	Absolute	Position control	End	Single	0	30,000	0	1	2,000	100
10	Absolute	Speed control	End	Single	0	50,000	0	1	1,000	100
11	Absolute	Position control	End	Single	0	60,000	0	1	1,500	100
12	Absolute	Position control	End	Single	0	70,000	0	1	2,000	100

### (4) Operation Sequence

- P0009 (floating origin) switch On : set as the floating origin at the current position.
- BCD/SNS\_STEP switch input: enters the operation stop to change in P004 (enters 10 in this example).
- P000C (operation step change) switch On : the current operating step changes into 10.
- P000F (axis X start) On : indirect start is conducted with the changed step (10).
- P000A (deceleration stop) switch On : axis X, which is being operated with speed control, is decelerated and stopped by the deceleration time of the current step.

## 7.2.6 Simultaneous Start

### (1) Ladder program

- The program example of simultaneous start of axes X, Y is as follows.

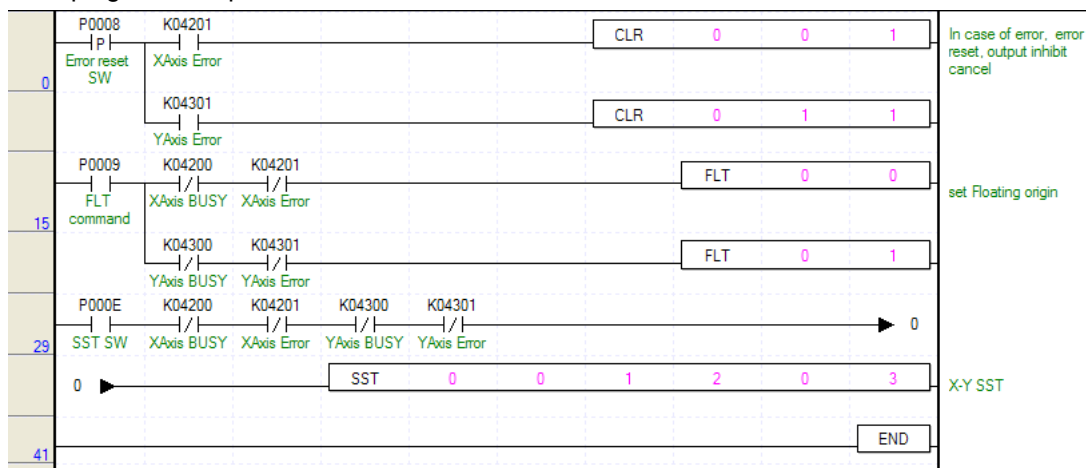

### (2) Devices Used

Device	Description
P0008	axes X and Y error reset, output inhibition cancel switch
P0009	axes X and Y floating origin switch
P000E	simultaneous start switch of axes X and Y
K4200	Signal during axis X operation
K4201	Error signal of axis X
K4300	Signal during axis Y operation
K4301	Axis Y error signal

### (3) Operation Data Setting

Axis	Step No.	coordinates	Control pattern	Operation pattern	Operation type	Repeat step	Target position [pulse]	M code	Acc./Dec. No.	Operation speed [pls/s]	Dwell time [ms]
X	1	Absolute	Position control	End	Single	0	10,000	0	1	1000	100
Y	2	Absolute	Position control	End	Single	0	20,000	0	1	2000	100

### (4) Operation Sequence

- P0009 (floating origin) switch On : set as the floating origin at the current position.
- P000F (simultaneous start) switch On : axis X simultaneously starts step 1, and axis Y does step 2.

## 7.2.7 Position Synchronous Start

### (1) Ladder program

• The program example of position synchronous start is as follows.

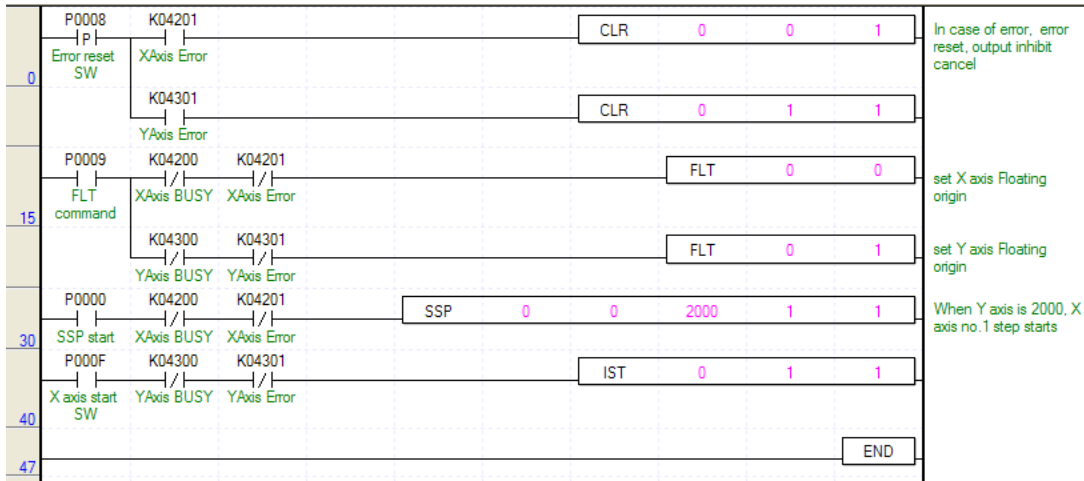

### (2) Devices Used

Device	Description
P0008	axes X and Y error reset, output inhibition cancel switch
P0009	axes X and Y floating origin switch
P000D	Axis X position synchronous switch
P000F	Indirect start switch f axis Y
K4200	Signal during axis X operation
K4201	Error signal of axis X
K4300	Signal during axis Y operation
K4301	Axis Y error signal

### (3) Operation Data Setting

Axis	Step No.	coordinate s	Control pattern	Operation pattern	Operation type	Repeat step	Target position [pulse]	M code	Acc./Dec. No.	Operation speed [pls/s]	Dwell time [ms]
X	1	Absolute	Position control	End	Single	0	10,000	0	1	1000	100
Y	1	Absolute	Position control	End	Single	0	20,000	0	1	2000	100

### (4) Operation Sequence

- P0009 (floating origin) switch On : set as the floating origin at the current position.
- P000D (synchronous start) switch On : axis X starts position synchronous start with axis Y being the main axis.
- P000F (Axis Y start) switch On : axis Y starts the step operation. If the position of axis Y reaches 2,000, axis X is synchronized to this, starting step 1.

### 7.2.8 Speed Synchronous Start

(1) Ladder program

• The program example of speed synchronous start is as follows.

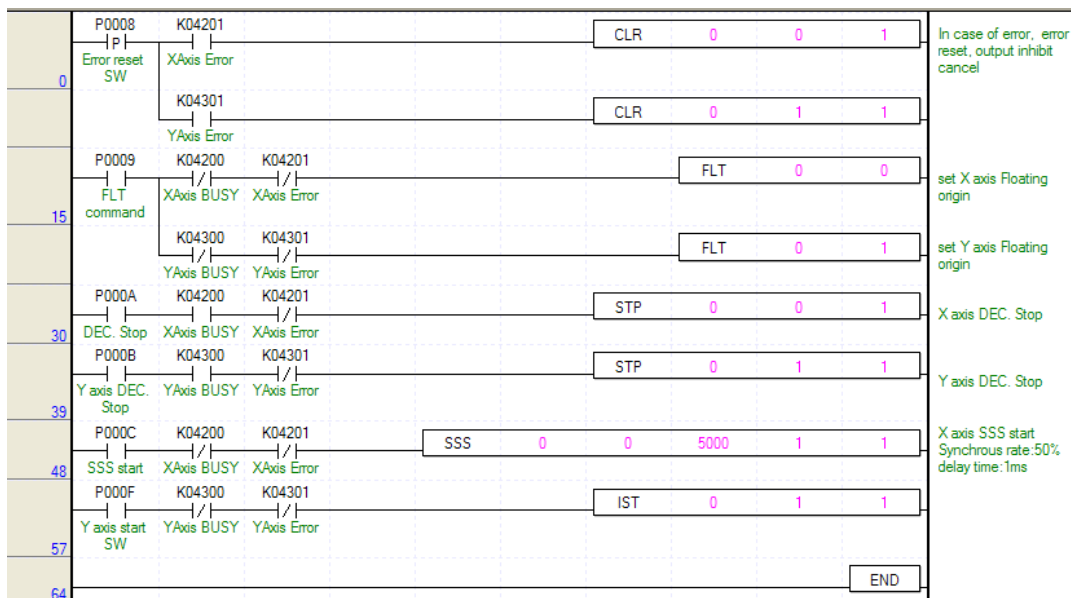

(2) Devices Used

Device	Description
P0008	axes X and Y error reset, output inhibition cancel switch
P0009	Floating origin switch of axes X and Y
P000A	axis X deceleration stop switch
P000B	deceleration stop switch of axis X
P000C	axis X speed synchronous start switch
P000F	indirect start switch of axis Y
K4200	Signal during axis X operation
K4201	Error signal of axis X
K4300	Signal during axis Y operation
K4301	Axis Y error signal

(3) Operation Data Setting

Axis	Step No.	coordinates	Control pattern	Operation pattern	Operation type	Repeat step	Target position [pulse]	M code	Acc./Dec. No.	Operation speed [pls/s]	Dwell time [ms]
X(auxiliary axis)	1	Absolute	Position control	End	Single	0	10,000	0	1	1000	100
Y(main axis)	1	Absolute	Speed control	End	Single	0	15000	0	1	1000	100

(4) Operation Sequence

- P0009 (floating origin) switch On : set as the floating origin at the current position.
- P000C (synchronous start) switch On : axis X starts speed synchronous start with axis Y being the main axis.
- P000F (Axis Y start) switch On : axis Y starts step 1 operation. Axis X is synchronized to the speed of 50,00%of axis Y and started.

## 7.2.9 Emergency Stop

### (1) Ladder program

• The program example of emergency stop during operation is as follows.

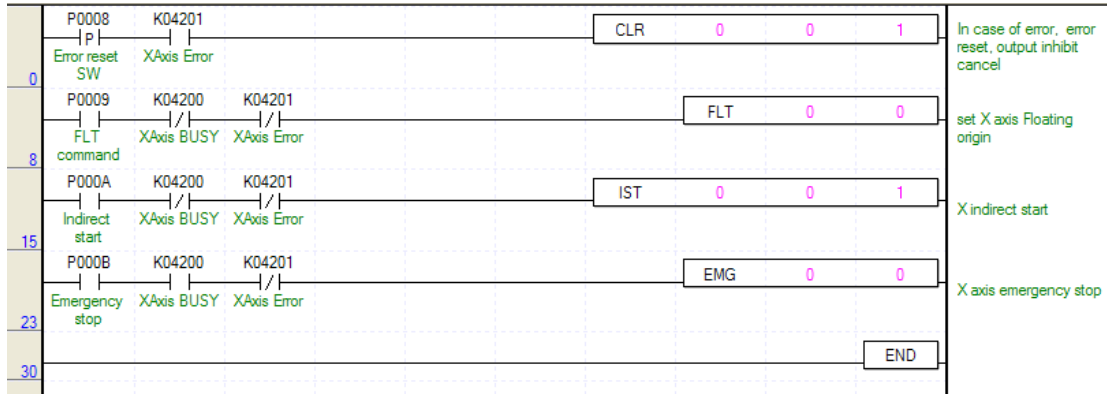

### (2) Devices Used

Device	Description
P0008	Error reset, output inhibition cancel switch in case of emergency stop
P0009	axis X home return switch
P000B	emergency stop switch during home return
K4200	Signal during axis X operation

### (3) Operation Data Setting

Step No.	coordinates	Control pattern	Operation pattern	Operation type	Repeat step	Target position [pulse]	M code	Acc./Dec. No.	Operation speed [pls/s]	Dwell time [ms]
1	Absolute	Speed control	End	Single	0	10000	0	1	1000	100

### (4) Operation Sequence

- P0009 (floating origin) switch On : set as the floating origin at the current position.
- P000A (indirect start) switch On : axis X indirectly starts step 1 and starts speed control.
- P000B (emergency stop) switch On : axis X does emergency stop without deceleration and the output is inhibited.

## 7.2.10 Jog Operation

### (1) Ladder program

• The program example of jog operation is as follows.

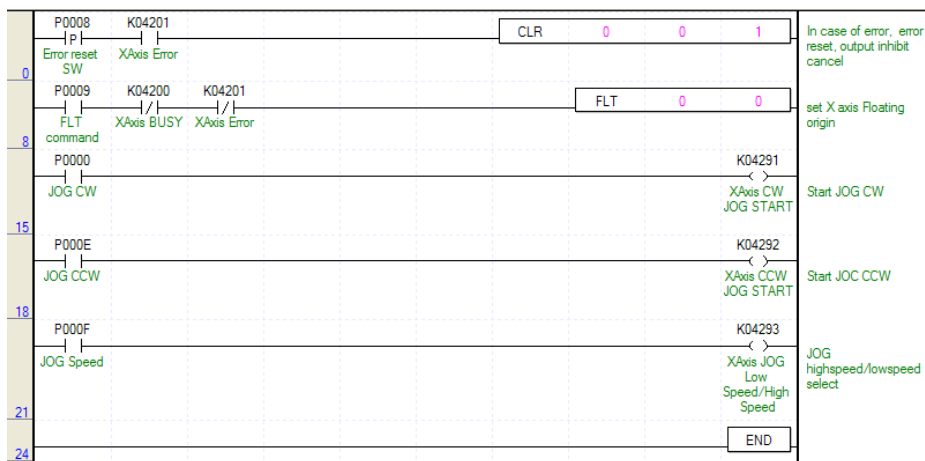

### (2) Devices Used

Device	Description
P0008	Axis X error reset, output inhibition cancel switch
P0009	axis X floating origin switch
P000D	axis X jog normal direction start switch
P000E	axis X jog reverse direction start switch
P000F	Switch for low/high speed selection of axis X jog
K4200	Signal during axis X operation
K4201	Error signal of axis X

### (3) Operation Sequence

- P0009 (floating origin) switch On : set as the floating origin at the current position.
- P000D (jog normal direction) switch On : axis X starts normal direction jog operation.
- P000F (jog speed) switch On : axis X is converted to jog high speed.
- P000D (jog normal direction) switch Off : axis X does jog stop.
- P000E (jog reverse direction) switch On : axis X starts reverse direction jog operation.
- P000E (jog reverse direction) switch Off : axis X does jog stop.

### 7.2.11 Speed Override

#### (1) Ladder program

• The program example of speed override during operation is as follows.

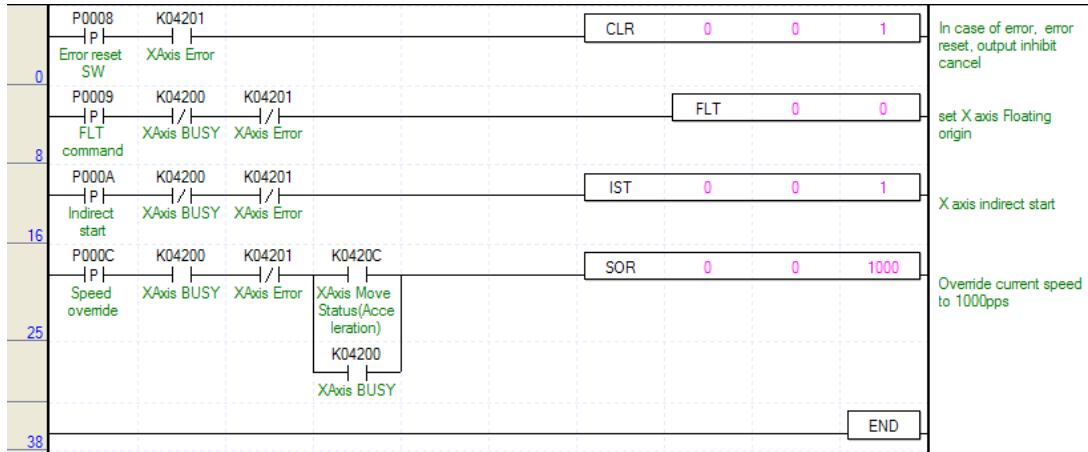

#### (2) Devices Used

Device	Description
P0008	Axis X error reset, output inhibition cancel switch
P0009	axis X floating origin switch
P000A	axis X indirect start switch
P000C	axis X speed override switch
K4200	Signal during axis X operation
K4201	Error signal of axis X
K420C	axis X acceleration signal
K420D	axis X constant speed signal

#### (3) Operation Data Setting

Step No.	coordinates	Control pattern	Operation pattern	Operation type	Repeat step	Target position [pulse]	M code	Acc./Dec. No.	Operation speed [pls/s]	Dwell time [ms]
1	Absolute	Position control	End	Single	0	100000	0	1	5000	100

#### (4) Operation Sequence

- P0009 (floating origin) switch On : set as the floating origin at the current position.
- P000A (indirect start) switch On : axis X indirectly starts step 1.
- P000C (speed override) switch On : overrides the current speed to 1000pps during acceleration or constant speed operation of axis X.



## 7.2.12 Position Override

### (1) Ladder program

• The program example of position override during operation is as follows.

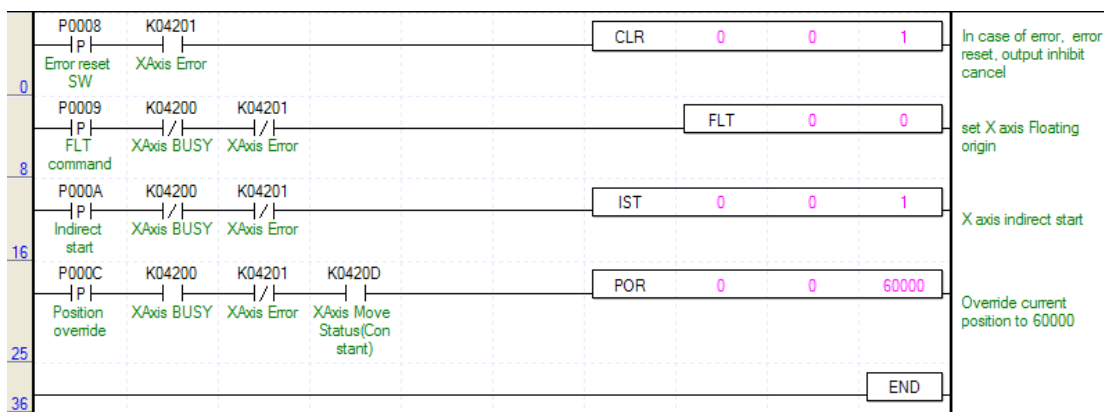

### (2) Devices Used

Device	Description
P0008	Axis X error reset, output inhibition cancel switch
P0009	axis X floating origin switch
P000A	axis X indirect start switch
P000C	axis X position override switch
K4200	Signal during axis X operation
K4201	Error signal of axis X
K420D	axis X constant speed signal

### (3) Operation Data Setting

Step No.	coordinates	Control pattern	Operation pattern	Operation type	Repeat step	Target position [pulse]	M code	Acc./Dec. No.	Operation speed [pls/s]	Dwell time [ms]
1	Absolute	Position control	End	Single	0	100000	0	1	5000	100

### (4) Operation Sequence

- P0009 (floating origin) switch On : set as the floating origin at the current position.
- P000A (indirect start) switch On : axis X indirectly starts step 1.
- P000C (position override) switch On : overrides the current position to 60,000 when the current position is below 60,000.

### 7.2.13 Speed Override with Position

#### (1) Ladder program

• The program example of positioning speed override during operation is as follows

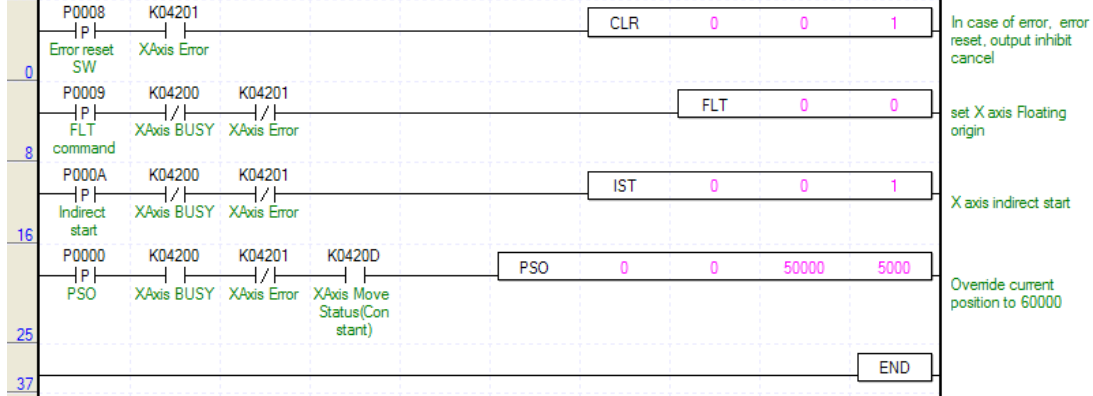

#### (2) Devices Used

Device	Description
P0008	Axis X error reset, output inhibition cancel switch
P0009	axis X floating origin switch
P000A	axis X indirect start switch
P000D	axis X positioning speed override switch
K4200	Signal during axis X operation
K4201	Error signal of axis X
K420D	axis X constant speed signal

#### (3) Operation Data Setting

Step No.	coordinates	Control pattern	Operation pattern	Operation type	Repeat step	Target position [pulse]	M code	Acc./Dec. No.	Operation speed [pls/s]	Dwell time [ms]
1	Absolute	Position control	End	Single	0	100000	0	1	10000	100

#### (4) Operation Sequence

- P0009 (floating origin) switch On : set as the floating origin at the current position.
- P000A (indirect start) switch On : axis X indirectly starts step 1.
- P000D (positioning speed override) switch On : overrides the current speed to 5000 when the current position reaches 50,000.

## 7.2.14 Speed, Position, and Parameter Teaching

### (1) Ladder program

- The program example of teaching of speed, position, and operation parameter is as follows

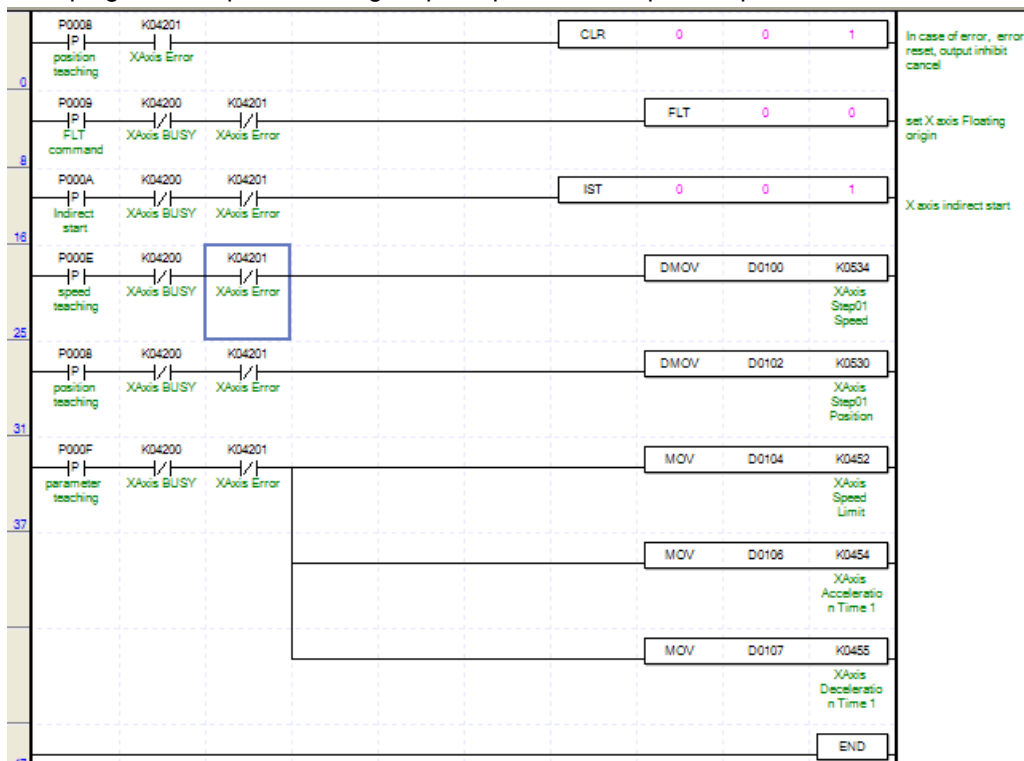

### (2) Devices Used

Device	Description
P0008	Axis X error reset, output inhibition cancel switch
P0009	axis X home return switch
P000A	axis X start switch
P000E	axis X speed teaching switch
P000B	axis X position teaching switch
P000F	axis X parameter teaching switch
K4200	Signal during axis X operation
K4201	Error signal of axis X
K534 ~ K535	axis X step 1 operation speed
D0100 ~ D0101	axis X speed change data (3000)
K530 ~ K531	axis X step 1 target position
D0100 ~ D0101	axis X speed change data (5000)
K452 ~ K453	axis X speed limit
K454	axis X deceleration time
K455	axis X acceleration time
D0100 ~ D0101	axis X speed limit setting data (10000)
D0102	axis X deceleration time 1 setting data (50)
D0103	axis X deceleration time 1 setting data (50)

## (3) Operation Data Setting

Step No.	coordinates	Control pattern	Operation pattern	Operation type	Repeat step	Target position [pulse]	M code	Acc./Dec. No.	Operation speed [pls/s]	Dwell time [ms]
1	Relative	Position control	End	Repeat	1	10,000	0	1	1000	100

## (4) Positioning Basic Parameter Setting

Parameter	Set value
Speed limit	100,000
Acceleration time 1	100
Deceleration time 1	100

## (5) Operation Sequence

- P0009 (floating origin) switch On : set as the floating origin at the current position.
- P000A (indirect start) switch On : axis X indirectly starts step 1.
  - speed : 1,000[pps]
  - target position : 10,000[Pulse]
  - acceleration/deceleration time : 100[ms]
- P000E (speed teaching) switch On after positioning is completed: speed of step 1 changes to 3,000[pps].
- P000A (indirect start) switch On : axis X indirectly starts step 1 again.
  - speed : changes to 3,000[pps] and operates.
  - target position : 10,000[Pulse]
  - acceleration/deceleration time : 100[ms]
- P000B (position teaching) switch On after positioning is completed: the target position of step 1 changes to 5,000.
- P000A (indirect start) switch On : axis X indirectly starts step 1 again.
  - speed : 3,000[pps]
  - target position : changes to 5,000[Pulse] and operates.
  - acceleration/deceleration time : 100[ms]
- P000F (parameter teaching) switch On after positioning is completed: positioning basic parameter is changed.
- P000A (indirect start) switch On : axis X indirectly starts step 1 again.
  - speed : 3,000[pps]
  - target position : 5,000[Pulse]
  - acceleration/deceleration time : changes to 50[ms] and operates.

**Remark**

## • Permanent Storage of Teaching Data

- If you have changed the operation data and parameter by using the DMOV instruction, you need to use the WRT instruction to save the changed value in the flash memory. Otherwise, it is initialized to the value saved in the previous flash memory when the power is off or the mode is changed.



## Chapter 8 Troubleshooting Procedure

This chapter describes the errors that occur during the use of XGB PLC and the built-in positioning function, the method of finding the cause of the error, and the actions to take.

### 8.1 Basic Procedure of Troubleshooting

Although it is important to use a highly reliable device for normal operation of the system, it is important as well how to deal with a trouble quickly.

In case of a trouble, if you want to restart the system, it is critical to find the cause of the trouble and take an action as soon as possible. The basic troubleshooting points you need to keep in mind are as follows.

#### (1) Check with Naked Eye

Check the following with your naked eye.

- Operation of the machine (in motion, not in motion)
- Power supply – whether the rated voltage is normally supplied to XGB PLC
- Condition of the input and output devices
- Distribution (input and output lines, communication cables, expansion)
- Check the Indicators (PWR LED, RUN LED, STOP LED, input and output LED), and access the peripheral devices to check the PLC operation and program contents.

#### (2) Trouble Check

When you manipulate the device as follows, observe how the trouble develops.

- Turn the operation mode switch to STOP and turn On / Off.

#### (3) Supposition of the Cause of Trouble

Suppose which of the following the cause of the trouble is.

- Whether the cause is in the PLC or an external device
- If the trouble is in the PLC, decide whether it is the trouble of the basic unit or other expansion modules.
- In the former is the case, decide whether there is a problem with the PLC parameter/program or hardware.

## 8.2 Check by Using the LED

If there is trouble in using the XGB built-in positioning function, you can roughly presume the cause of the trouble by checking the LED of XGB PLC. This chapter describes the LED related to the trouble of the positioning function. With respect to the trouble that occurs during use of other functions of the basic unit, refer to 'Hardware section of the XGB Manual.'

### 8.2.1 LED Check

If there is trouble during use of the positioning function, check the status of PWR LED, RUN LED and ERR LED of XGB PLC, and check the LED of the input and output contact point related to positioning.

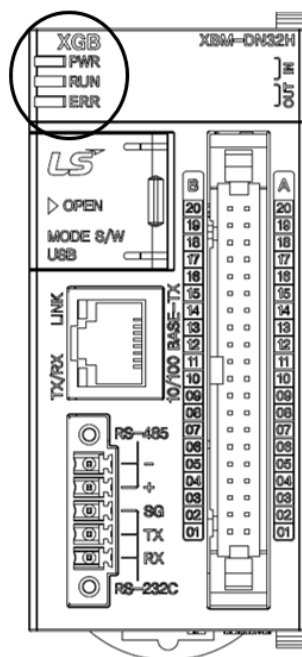

#### (1) PWR LED Check

Check the PWR LED status and take the following actions.

LED	PLC trouble	Actions to take
On	<ul style="list-style-type: none"> <li>Rated voltage is normally supplied to XGB.</li> </ul>	<ul style="list-style-type: none"> <li>The power supply is normal, so check whether there is another cause.</li> </ul>
Flashing	<ul style="list-style-type: none"> <li>One of the following might be the cause.               <ul style="list-style-type: none"> <li>- Rated voltage/current set for the XGB is not being supplied.</li> <li>- Problem with the PLC hardware</li> <li>- Problem with external lines</li> </ul> </li> </ul>	<ul style="list-style-type: none"> <li>Check the voltage and current of the power supply.</li> <li>Remove the input and output lines, re-supply power and check again.               <ul style="list-style-type: none"> <li>- If there still is the same problem, contact the A/S office or customer center.</li> </ul> </li> </ul>
Off	<ul style="list-style-type: none"> <li>Power is not being supplied.</li> <li>Supplied voltage is lower than the rated voltage.</li> <li>The cable is severed.</li> <li>There is a problem with the PLC hardware.</li> </ul>	<ul style="list-style-type: none"> <li>Check whether rated voltage is being normally supplied to the PLC.               <ul style="list-style-type: none"> <li>- If normally supplied, contact an A/S office or customer center.</li> </ul> </li> </ul>

## (2) RUN LED Check

LED	PLC trouble	Actions to take
On	<ul style="list-style-type: none"> <li>The program is being normally operated.</li> </ul>	<ul style="list-style-type: none"> <li>Check whether there is another cause.</li> </ul>
Off	<ul style="list-style-type: none"> <li>The running of the program has stopped.</li> </ul>	<ul style="list-style-type: none"> <li>The program has stopped.               <ul style="list-style-type: none"> <li>- Check the ERR LED to find whether it is because of an error or the operation mode is STOP.</li> </ul> </li> </ul>

## (3) ERR LED Check

LED	PLC trouble	Actions to take
On	<ul style="list-style-type: none"> <li>A problem with the PLC hardware</li> </ul>	<ul style="list-style-type: none"> <li>There is a problem with the PLC hardware, so contact an A/S office or customer center.</li> </ul>
Flashing	Quick flashing (0.1 sec) <ul style="list-style-type: none"> <li>Serious trouble that makes operation impossible</li> </ul>	<ul style="list-style-type: none"> <li>Access XGB with XG5000, execute 'Online' → 'PLC error/warning', check the error and warning, and remove the cause.</li> </ul>
	Slow flashing (0.5 sec) <ul style="list-style-type: none"> <li>A minor problem with operation continuing</li> </ul>	
On	<ul style="list-style-type: none"> <li>The program is being normally run.</li> </ul>	<ul style="list-style-type: none"> <li>The program is being normally run, so check whether there is another problem.</li> </ul>

## (4) Positioning Output LED Check

If no problem is found as a result of the check of the LED, check the LED of the output contact point related to the positioning function, and take the following actions.

Signal	Contact point	LED status	Error and actions to take
Pulse output	P20,P21	Fast flashing	<ul style="list-style-type: none"> <li>Pulse is being normally output by the positioning function.</li> <li>Check whether there is a problem with the lines of the XGB and motor driver.</li> </ul>
		Off	<ul style="list-style-type: none"> <li>Pulse is not being normally output.               <ul style="list-style-type: none"> <li>- Positioning operation has finished (normal).                   <ul style="list-style-type: none"> <li>→ Start the next operation instruction.</li> </ul> </li> <li>- There is an error that makes positioning operation impossible.                   <ul style="list-style-type: none"> <li>→ Check the positioning error code and remove the cause.</li> </ul> </li> </ul> </li> <li>For the method of check the error code, refer to Appendix 1.1.</li> </ul>



Signal	Contact point	LED status	Output level	Error and actions to take
Direction output	P22,P23	On	Low Active	<ul style="list-style-type: none"> <li>• Direction signals are being output in the normal direction (normal).</li> </ul>
			HIGH Active	<ul style="list-style-type: none"> <li>• Direction signals are being output in the reverse direction (normal).</li> <li>• Pulse is not being normally output                             <ul style="list-style-type: none"> <li>- Positioning operation has finished (normal)                                     <ul style="list-style-type: none"> <li>→ Start the next operation instruction.</li> </ul> </li> <li>- There is an error that makes positioning operation impossible                                     <ul style="list-style-type: none"> <li>→ Check the positioning error code and remove the cause.</li> </ul> </li> </ul> </li> </ul>
		Off	Low Active	<ul style="list-style-type: none"> <li>• Direction signals are being output in the reverse direction (normal)</li> <li>• Pulse is not being normally output                             <ul style="list-style-type: none"> <li>- Positioning operation has finished (normal)                                     <ul style="list-style-type: none"> <li>→ Start the next operation instruction.</li> </ul> </li> <li>- There is an error that makes positioning operation impossible                                     <ul style="list-style-type: none"> <li>→ Check the positioning error code and remove the cause.</li> </ul> </li> </ul> </li> </ul>
			HIGH Active	<ul style="list-style-type: none"> <li>• Direction signals are being output in the normal direction (normal).</li> </ul>

**Remark**

- If PWR, RUN, and ERR LED are all off, there is a problem with the internal operation system of XGB. In such a case, XGB PLC cannot normally operate, so inquire of the customer center.

## 8.3 Check by Error Code

If there is found to be an error as a result of the check of the LED related to positioning, access XGB with XG5000, check the positioning error code, and remove the cause.

This chapter only describes how to check the positioning error codes. With respect to the details of error codes and actions to take, refer to Appendix 1.1.

### 8.3.1 How to Check Error Codes

The built-in positioning error code can be checked by using the XGB positioning monitoring package or the positioning error code device of area K in the following procedure.

#### (1) Positioning Monitoring Package

(a) Access PLC with XG5000.

(b) Select 'Monitor' → 'Special Module Monitor' → 'Positioning Module,' the following monitoring package is executed.

Select 'Start Monitor' at the left bottom, you can check the error code.

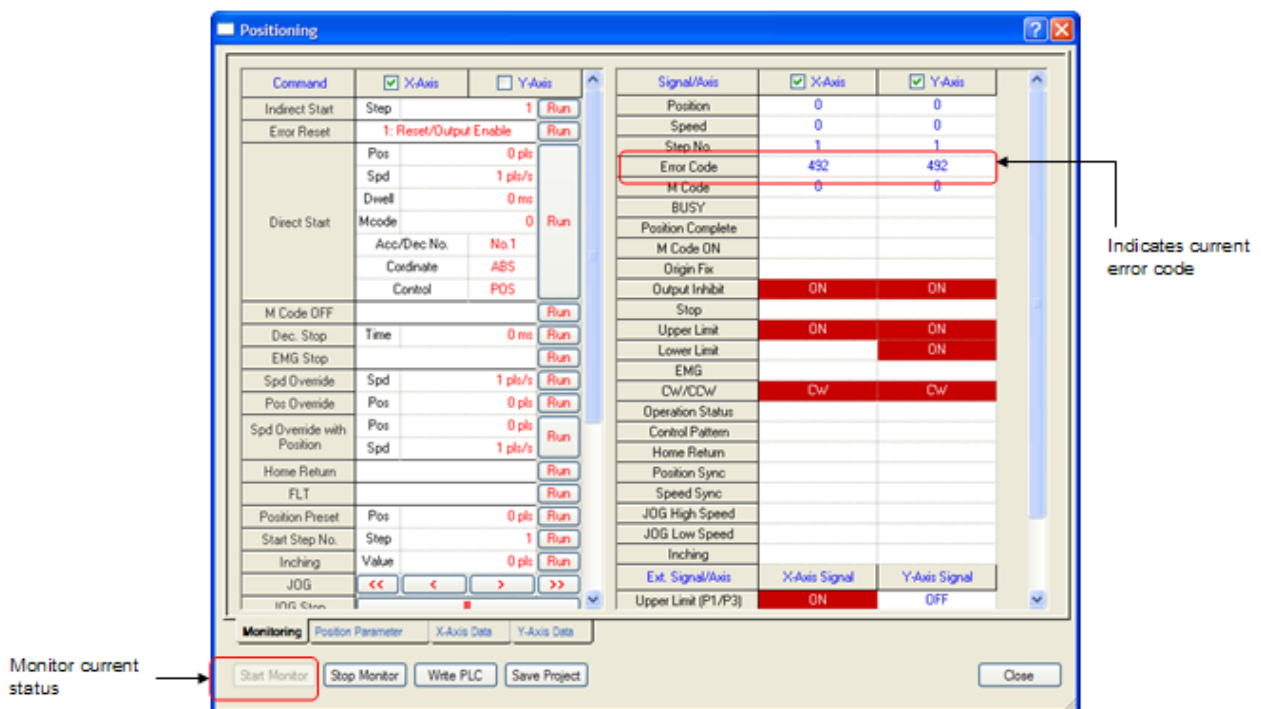

#### (2) Positioning Area K

(a) You can check the error code by using the device monitor function of XG5000.

(b) To check the error code of the XGB positioning function, monitor the following device. About how to use the device monitor, refer to the manual of XG5000.

	Area K address	Data size
Axis X	K427(%KW427)	Word
Axis Y	K437(%KW437)	Word

## (3) Lists of error code

Error code	Description	Operation	Countermeasures
101	Exceeding the max speed range of basic parameter	Stop	Change the max speed value
102	Exceeding the bias speed of basic parameter 1) bias speed $\geq$ Speed limit 2) bias speed = 0	Stop	Re-adjust it lower than the max speed of basic parameter.
103	ACC time setting error 1) ACC time > 10,000 2) Jog ACC time > 10,000	Stop	Re-adjust ACC time of basic parameter lower than 10,000
104	DEC time setting error 1) DEC time > 10,000 2) Jog DEC time > 10,000	Stop	Re-adjust DEC time of basic parameter lower than 10,000
105	Setting non use dedicated positioning at parameter	Stop	Setting dedicate positioning.
111	Expansion parameter soft upper/lower limit error • SW upper > SW lower	Stop	Re-adjust SW upper limit equal to or larger than the lower limit.
121	Manual operation parameter jog high speed range exceeding error 1) Jog high speed < bias speed 2) Jog high speed >> max speed 3) Jog high speed = 0 4) Jog high speed < Jog low speed	Stop	Re-adjust to be max speed $\geq$ jog high speed $\geq$ bias speed
122	Manual operation parameter jog low speed range exceeding error 1) Jog low speed < bias speed 2) Jog low speed > max speed 3) Jog low speed = 0 4) Jog low speed > Jog high speed	Stop	Re-adjust to be jog high speed $\geq$ jog low speed $\geq$ 1.
123	Manual operation parameter inching speed range exceeding error 1) inching speed < bias speed 2) inching speed >> max speed	Stop	Re-adjust to be max speed $\geq$ inching speed $\geq$ bias speed
131	Home return parameter home return mode value range exceeding error	Stop	Re-adjust to be $0 < \text{home return parameter} \leq 3$ . (1:Dog/origin(On) 2:upper/lower limit/origin 3:DOG)
132	Home return parameter home return address range exceeding error	Stop	Re-adjust to be SW upper limit $\geq$ home return address $\geq$ SW lower limit
133	Home return parameter home return high speed range exceeding error 1) home return high speed < bias speed 2) home return high speed > max speed	Stop	Re-adjust to be max speed $\geq$ home return high speed $\geq$ bias speed
134	Home return parameter home return low speed range exceeding error 1) home return low speed < bias speed 2) home return low speed > home return high speed	Stop	Re-adjust to be home return high speed $\geq$ home return low speed $\geq$ bias speed
135	Home return dwell time out error of home return parameter • Home return dwell time > 50,000	Stop	Re-adjust dwell time lower than 50000.

## Chapter 8 Troubleshooting Procedure

Error code	Description	Operation	Countermeasures
136	Home return ACC time setting error • Home return ACC time > 10,000	Stop	Re-adjust home return ACC time lower than 10,000
137	Home return DEC time setting error • Home return DEC time > 10,000	Stop	Re-adjust home return Dec time lower than 10,000.
151	Operation speed '0' setting error of operation data	Stop	Set operation speed over '0'.
152	Operation speed of operation data exceeding the max speed	Stop	Re-adjust to be max speed $\geq$ operation speed.
153	Operation speed of operation data set lower than bias speed.	Stop	Re-adjust to be operation speed $\geq$ bias speed.
154	Exceeding dwell time setting range of operation data	Stop	Set dwell time lower than 50000.
155	Exceeding end/continuous/sequential setting range of operation data	Stop	Re-set operation pattern of operation data as one of 0:end, 1:continuous or 2:sequential
201	Home return command is unavailable during operation	Stop	Check whether command axis was not operating at the time of home return command.
202	Home return command is unavailable in case of 'no output' status.	Stop	Check whether command axis was not in 'no output' status at the time of home return command.
211	Floating origin setting command is unavailable during operation.	Stop	Check whether command axis was not operating at the time of floating origin setting command.
221	Direct start command is unavailable during operation.	Stop	Check whether command axis was not operating at the time of direct start command
222	Direct start command is unavailable in case of 'no output' status.	Stop	Check whether command axis was not in 'no output' status at the time of direct start command.
223	Direct start command is unavailable in case of M code On	Stop	Check whether M code of command axis was not On at the time of direct start command.
224	Direct start command is unavailable without origin set in absolute coordinate.	Stop	Absolute coordinate operation is not available without origin set. Check whether operation data to operate and the current origin set.
231	Indirect start command is unavailable during operation	Operation	Check whether command axis was not operating at the time of indirect start command.
232	Indirect start command is unavailable in case of 'no output' status.	Stop	Check whether command axis was not in 'no output' status at the time of indirect command.
233	Indirect start command is unavailable in case of M code On.	Stop	Check whether M code signal of command axis was not On at the time of indirect start command.
234	Indirect start command is unavailable without origin set in absolute coordinate.	Stop	Absolute coordinate operation is not available without origin set. Check whether operation data to operate and the current origin set.
236	Continuous operation of indirect start is unavailable in speed control.	Stop	Re-set single or continuous operation if operation data control method is speed
241	Linear interpolation start is unavailable when main axis of linear interpolation is operating.	Operation	Check whether main axis was not operating at the time of linear interpolation command.
242	Linear interpolation start is unavailable when sub axis of linear interpolation is operating.	Operation	Check whether sub axis was not operating at the time of linear interpolation command.

## Chapter 8 Troubleshooting Procedure

Error code	Description	Operation	Countermeasures
244	Linear interpolation start is unavailable when main axis of linear interpolation is in 'Output disabled' status.	Stop	Check whether main axis was not in 'Output disabled' status at the time of linear interpolation command.
245	Linear interpolation start is unavailable when sub axis of linear interpolation is in 'Output disabled' status.	Stop	Check whether a sub axis was not in 'Output disabled' status at the time of linear interpolation command.
247	Linear interpolation start is unavailable when the M code signal of linear interpolation's main axis is On.	Stop	Check whether M code signal of main axis was not On at the time of linear interpolation command.
248	Linear interpolation start is unavailable when M code signal of linear interpolation's sub axis is On.	Stop	Check whether M code signal of sub axis was not On at the time of linear interpolation.
250	Absolute coordinate positioning operation is unavailable when the origin of linear interpolation sub axis is not set.	Stop	Absolute coordinate operation is not available without origin set. Check whether operation data to operate and the current origin set.
251	Absolute positioning operation is unavailable when the origin of linear interpolation's sub axis is not set.	Stop	Absolute coordinate operation is not available without origin set. Check whether operation data to operate and the current origin set.
253	Main axis and sub axis of linear interpolation are set incorrectly.	Stop	Re-set the axis data as 3 of linear interpolation command.
257	Linear interpolation is not available when the target position of main axis does not have a target position.	Stop	Check whether the target position of operation data of a step for linear interpolation was not the present status in case of absolute coordinate or set to '0' in case of Incremental coordinate.
258	Linear interpolation is unavailable when main axis is controlling speed.	Stop	Check whether the control method of main axis operation data step for linear interpolation operation was not set by speed control.
259	Linear interpolation is unavailable when sub axis is controlling speed.	Stop	Check whether the control method of sub axis operation data step for linear interpolation was not set by speed control.
291	Concurrent start command is unavailable during operation.	Operation	Check whether an axis with error was not contained in concurrent start command and whether there wasn't any operating axis at the time of the command
292	Concurrent start command is unavailable in 'no output' status.	Stop	Check whether an axis with error was not contained in concurrent start command and whether it was not in 'no output' status at the time of the command.
293	Concurrent start command is not available with M code On	Stop	Check whether an axis with error was not contained in concurrent start command and whether M code signal was not On at the time of the command.
294	Concurrent start command is unavailable without origin set	Stop	Concurrent start command with origin set
296	When concurrent start command axis is incorrectly set.	Stop	Re-set the axis data as 3 of concurrent start command
301	Speed/position switching command is unavailable while not operating.	Stop	Check whether an axis did not stop at the time of speed/position switching command.
302	Speed/position switching command is unavailable while not controlling speed.	Stop	Check whether an axis was not in speed control status at the time of speed/position switching command.
304	Speed/position switching command is unavailable without target position.	Stop	Check whether operation had a move(amount) at the time of speed/position switching command.

## Chapter 8 Troubleshooting Procedure

Error code	Description	Operation	Countermeasures
311	Position/speed switching command is unavailable while not operating.	Stop	Check whether an axis did not stop at the time of position/speed switching command.
312	Position/speed switching command is unavailable. On a sub axis of synchronic operation.	Stop	Check whether an axis was operating as a synchronic operation sub axis at the time of position/speed switching command.
314	Position/speed switching command is unavailable during linear operation.	Operation	Check whether an axis was not in linear interpolation operation at the time of position/speed switching command.
321	DEC stop command is unavailable while not operating.	Stop	Check whether it was not operating at the time of DEC stop command.
322	DEC stop command is not available during jog operation.	Operation	Check whether it was not jog-operating at the time of DEC stop command.
341	Position synchronic command is not available during operation	Operation	Check whether an axis was not in operating at the time of position synchronic command
342	Position synchronic command is unavailable in 'no output' status.	Stop	Check whether an axis was not in 'no output' status at the time of position synchronic command.
343	Position synchronic command is unavailable with M code On.	Stop	Check whether M code signal of an axis was not On at the time of position synchronic command.
344	Position synchronic command is unavailable without origin set.	Stop	Absolute coordinate operation is not available without origin set. Check whether operation data to operate and the current origin set.
346	Position synchronic command is unavailable without origin of main axis set.	Stop	Check whether main axis was without origin set at the time of position synchronic command.
347	There is an error of setting main/sub axis of position synchronic command.	Stop	Check whether main axis of position synchronic command was not set equally with command axis.
351	Speed synchronic command is unavailable during operation.	Operation	Check whether an axis was not operating at the time of speed synchronic command.
352	Speed synchronic command is unavailable in 'no output' status.	Stop	Check whether an axis was not in 'no output' status at the time of speed synchronic command.
353	Speed synchronic command is unavailable with M code On	Stop	Check whether M code signal of an axis was not On at the time of speed synchronic command.
355	There is an error of main/sub axis setting of speed synchronic command. 1) main/ sub axis were set equally 2) set of main axis >5	Stop	Check whether the main axis of speed synchronic command was not set equally with command axis.
356	There is an error of synchronization ratio setting of speed synchronic command	Stop	Check whether the synchronization ratio of speed synchronic command was not set between 0~10,000.
357	Delay time setting error	Stop	Check whether delay time was set between 1 ~ 10ms.
361	Position override command is unavailable in any other status but 'busy'	Stop	Check whether an axis did not stop at the time of position override command.
362	Position override command is unavailable during dwelling	Stop	Check whether an axis was not dwelling at the time of position override command.
363	Position override command is unavailable in any other status but positioning operation.	Operation	Check whether an axis was not operating by position control at the time of position override command.
364	Position override command is unavailable for an axis of linear interpolation operation.	Operation	Check whether an axis was not in linear-interpolation operation at the time of position override command.

## Chapter 8 Troubleshooting Procedure

Error code	Description	Operation	Countermeasures
366	Position override command is unavailable for a synchronic operation sub axis.	Operation	Check whether an axis was not operating as a sub axis of synchronic operation at the time of position override command.
371	Speed override command is unavailable in any other status but 'busy'.	Stop	Check whether an axis did not stop at the time of speed override command.
372	Out-of speed override range error	Stop	Re-set the speed of speed override command equal to or lower than the max speed set in the basic parameter.
373	Speed override command is unavailable to an sub axis of linear interpolation operation.	Operation	Check whether an axis was not operating as a sub axis of linear interpolation at the time of speed override command.
375	Speed override command is unavailable to an sub axis of synchronic operation	Operation	Check whether an axis was not operating as a sub axis of synchronic operation at the time of speed override command.
377	Speed override command is unavailable in a DEC section	Operation	Check whether an axis was not decelerating for stoppage at the time of speed override command.
381	Positioning speed override command is unavailable in any other status but 'operation'.	Stop	Check whether an axis did not stop at the time of positioning speed override command.
382	Positioning speed override command is unavailable in any other operation but 'positioning operation'	Stop	Check whether an axis was not in speed control operation at the time of positioning speed override.
383	Out of speed override range error of positioning speed override command	Stop	Check whether the speed of positioning speed override command was not equal to or lower than the max speed set in parameter.
384	Positioning speed override command is unavailable to an sub axis of linear interpolation operation.	Operation	Check whether an axis was not operating as a sub axis of linear interpolation at the time of positioning speed override command.
386	Positioning speed override command is unavailable to an sub axis of synchronic operation.	Operation	Check whether an axis was not operating as a sub axis of synchronic operation at the time of positioning speed override command.
401	Inching command is unavailable during operation.	Operation	Check whether an axis was not operating at the time of inching command.
402	Inching command is unavailable in 'no output' status.	Stop	Check whether an axis was not in 'no output' status at the time of inching command.
411	Jog start command is unavailable during operation.	Operation	Check whether an axis was not operating at the time of jog start command.
412	Jog start command is unavailable in 'no output' status.	Stop	Check whether an axis was not in 'no output' status at the time of jog start command.
441	Start step number change/repeat operation start step number designation command is unavailable during operation.	Operation	Check whether an axis was not operating at the time of start step number change command.
442	Start step number change/repeat operation start step number command is unavailable during operation. 1) Step = 0 2) Step > 30(80 for high end)	Stop	Check whether the step number of start step number change command or repeat operation start step number designation command is equal to or higher than 1 and lower than 30(80 for high end) or within the range.
451	Present position preset command is unavailable during operation.	Operation	Check whether an axis was not operating at the time of present position present command.
452	Sub position data may not be set exceeding soft upper/lower limits at the time of present position preset command.	Stop	Check whether the position of present position present command was within the soft upper/lower limits.

## Chapter 8 Troubleshooting Procedure

Error code	Description	Operation	Countermeasures
481	emergency stop error	Stop	Remove emergency stop causes and clear the error by executing CLR command.
491	External emergency stop error	Stop	Remove emergency stop causes and clear the error with CLR command.
492	Hard upper limit error	Stop	Escape from external upper signal range by using jog command and clear the error with CLR command.
493	Hard lower limit error	Stop	Escape from external upper signal range by using jog command and clear the error with CLR command.
501	Soft upper limit error	Stop	Escape from soft upper limit range by using jog command and clear the error with CLR command.\
502	Soft lower limit error	Stop	Escape from soft lower limit range by using jog command and clear the error with CLR command.
511	Direction turning error during sequential operation	Stop	Check whether the direction are turned during sequential operation.
512	Step number error during indirect start.	Stop	A step over 30 was set in a command. Re-set step number between 1 ~ 30.
513	Address error during indirect start.	Stop	Check whether it repetitively operates a step of which address is '0' during indirection start.
601	PWM command is unavailable during operation.	Operation	Check whether an axis was not operating at the time of present position present command.
602	PWM command is unavailable in 'no output' status	Stop	Check whether an axis was not in 'no output' status at the time of inching command.
603	PWM Output Cycle setting error	Stop	Check whether PWM Output Cycle was set between 1 ~ 20,000.
604	PWM Off duty rate setting error	Operation/ Stop	Check whether PWM Off duty rate was set between 1 ~ 100.
605	Speed override command is unavailable during PWM operation	Operation	Check whether an axis was not in PWM operation at the time of speed override command.
606	Position/speed switching command is unavailable during PWM operation	Operation	Check whether an axis was not in PWM operation at the time of position/speed switching command.



## 8.4 Check of Motor Failures

If the motor does not work despite there being no problem after the check according to the procedure described above, check the following.

### 8.4.1 If the Motor Doesn't Work

#### (1) Lines between the XGB and Motor Driver

- Check whether the lines between XGB and servo motor driver are connected rightly.
- For the specifications of the input and output of XGB, refer to Chapter 2.
- For examples of wiring between XGB and the motor driver, refer to Appendix 3.
- If you use a motor driver that is not addressed in this manual, refer to the manual of that motor driver.

#### (2) Setting of the Motor Driver

- If there is no problem with the wiring, check whether the input pulse of the motor driver is the same as that of the XGB.
- XGB only supports the open collector type. Check whether the motor driver you are using can accommodate the type, and check the setting of the motor driver.

#### (3) Check of the Motor Driver

- If no problem is found as a result of the procedure above, check whether pulse is actually supplied to the motor driver by using the oscilloscope. If the motor driver isn't working despite the pulse actually being supplied, refer to the manual of the motor driver and check whether there is an error of the driver.

## Chapter9 Positioning Instruction and K area List

### 9.1 Positioning Instruction

Instruction used in the XGB positioning is as follows. For detail, refer to ch.5.2 ~ ch5.3

Instructions	Description	Conditions	Remark
ORG	Home starting	Slot, command axis	5.2.1
FLT	Float origin setting	Slot, command axis	5.2.2
DST	Direct starting	Slot, command axis, position, speed, dwell time, M code, control word	5.2.3
IST	Indirect starting	Slot, command axis, step no.	5.2.4
LIN	Linear interpolation starting	Slot, command axis, step no., axis information	5.2.5
SST	Simultaneous starting	Slot, command axis, X step, Y step, Z step, axis information	5.2.6
VTP	Speed/position change	Slot, command axis	5.2.7
PTV	position/speed change	Slot, command axis	5.2.8
STP	Stop	Slot, command axis, DEC. time	5.2.9
SSP	Position synchronization	Slot, command axis, step no., main axis position, main axis setting	5.2.10
SSS	Speed synchronization	Slot, command axis, synchronization rate, delay time	5.2.11
POR	Position override	Slot, command axis, position	5.2.12
SOR	Speed override	Slot, command axis, speed	5.2.13
PSO	Speed override with position	Slot, command axis, position, speed	5.2.14
INCH	Inching starting	Slot, command axis, inching amount	5.2.15
SNS	starting step no. change	Slot, command axis, step no.	5.2.16
MOF	M code cancel	Slot, command axis	5.2.17
PRS	Current position preset	Slot, command axis, position	5.2.18
EMG	EMG stop	Slot, command axis	5.2.19
CLR	Error reset, output inhibit cancel	Slot, command axis, pulse output inhibit/allowed	5.2.20
WRT	Parameter/operation data saving	Slot, command axis, storage area selection	5.2.21
PWM	Pulse width modulation	Slot, instruction axis, output cycle, off duty rate	5.2.22

#### Remark

- XGB positioning instructions are activated at the rising edge. That is, when the execution contact point is On, it carried out the instruction only once. (PWM instruction is activated at the "On" level).

## 9.2 Positioning Dedicated K area List

### 9.2.1 Positioning Deicated K area List

Item	Setting range	Initial value	K area for positioning		Data size
			X axis	Y axis	
Positioning	0 : Not use, 1 : use	0	K4870	K5270	bit
Pulse output level	0 : Low Active, 1 : High Active	0	K4871	K5271	bit
Pulse output mode	0 : CW/CCW, 1 : PLS/DIR	0	K4873	K5273	Bit
M Code Output Mode	0 : NONE, 1 : WITH 2 : AFTER	0	K4681 K4682	K5081 K5082	2bit
Bias speed	1 ~ 100,000[pulse/s]	1	K450	K490	Double word
Speed limit	1 ~ 100,000[pulse/s]	100,000	K452	K492	Double word
ACC No.1	0 ~ 10,000[unit: ms]	500	K454	K494	Word
DEC No.1	0 ~ 10,000[unit: ms]	500	K455	K495	Word
ACC No.2	0 ~ 10,000[unit: ms]	1,000	K456	K496	Word
DEC No.2	0 ~ 10,000[unit: ms]	1,000	K457	K497	Word
ACC No.3	0 ~ 10,000[unit: ms]	1,500	K458	K498	Word
DEC No.3	0 ~ 10,000[unit: ms]	1,500	K459	K499	Word
ACC No.4	0 ~ 10,000[unit: ms]	2,000	K460	K500	Word
DEC No.5	0 ~ 10,000[unit: ms]	2,000	K461	K501	Word
S/W Upper Limit	-2,147,483,648 ~ 2,147,483,647[pulse]	2,147,483,647	K462	K502	Double word
S/W Lower Limit	-2,147,483,648 ~ 2,147,483,647 [pulse]	-2,147,483,648	K464	K504	Double word
Backlash Compensation	0 ~ 65,535[pulse]	0	K466	K506	Word
S/W Limit Detect	0 : No Detect, 1 : Detect	0	K4684	K5084	Bit
Upper/Lower limit	0 : No Detect, 1 : Detect	1	K4872	K5272	Bit

### 9.2.2 K area of positioning home parameter

Item	Setting range	Initial value	Dedicated K area		Data size
			X axis	Y axis	
Home Method	0~2	0	K4780 K4781	K5180 K5181	Bit
Home Direction	0 : CW, 1 : CCW	1	K4782	K5182	Bit
Home Address	-2,147,483,648~2,147,483,647[pulse]	0	K469	K509	Double word
Home High Speed	1 ~ 100,000[pulse/s]	5,000	K471	K511	Double word
Home Low Speed	1 ~ 100,000[pulse/s]	500	K473	K513	Double word
Homing ACC Time	0 ~ 10,000[unit: ms]	1,000	K475	K515	Word
Homing DEC Time	0 ~ 10,000[unit: ms]	1,000	K476	K516	Word
DWELL Time	0 ~ 50,000[unit: ms]	0	K477	K517	Word
JOG High Speed	1 ~ 100,000[pulse/s]	5,000	K479	K519	Double word
JOG Low Speed	1 ~ 100,000[pulse/s]	1,000	K481	K521	Double word
JOG ACC Time	0 ~ 10,000[unit: ms]	1,000	K483	K523	Word
JOG DEC Time	0 ~ 10,000[unit: ms]	1,000	K484	K524	Word
Inching Speed	1 ~ 65,535[pulse/s]	100	K485	K525	Word

## 9.2.3 Positioning operation data K area

Step	Item	Setting range	Initial Value	Dedicated K area		Data size
				X axis	Y axis	
1	Coord.	0 : ABS, 1 : INC	ABS	K5384	K8384	Bit
	Pattern	0 : END, 1 : KEEP, 2 : CONT	END	K5382~3	K8382~3	Bit
	Control	0 : POS, 1 : SPD	POS	K5381	K8381	Bit
	Method	0 : SIN, 1 : REP	SIN	K5380	K8380	Bit
	REP Step	0 ~ 30 (0 ~ 80 for high - end)	0	K539	K839	Word
	Address[pulse]	-2,147,483,648 ~ 2,147,483,647 [pulse]	0	K530	K830	Double word
	M Code	0 ~ 65,535	0	K537	K837	Word
	A/D No.	0 : No.1, 1 : No.2, 2 : No.3, 3 : No.4	0	K5386~7	K8386~7	Bit
	Speed	1 ~ 100,000[pulse/s]	0	K534	K834	Double word
	Dwell	0 ~ 50,000[unit:ms]	0	K536	K836	Word
2	Coord.	0 : ABS, 1 : INC	ABS	K5484	K8484	Bit
	Pattern	0 : END, 1 : KEEP, 2 : CONT	END	K5482~83	K8482~83	Bit
	Control	0 : POS, 1 : SPD	POS	K5481	K8481	Bit
	Method	0 : SIN, 1 : REP	SIN	K5480	K8480	Bit
	REP Step	0 ~ 30 (0 ~ 80 for high - end)	0	K549	K849	Word
	Address[pulse]	-2,147,483,648 ~ 2,147,483,647 [pulse]	0	K540	K840	Double word
	M Code	0 ~ 65,535	0	K547	K847	Word
	A/D No.	0 : No.1, 1 : No.2, 2 : No.3, 3 : No.4	0	K5486~87	K8486~87	Bit
	Speed	1 ~ 100,000[pulse/s]	0	K544	K844	Double word
	Dwell	0 ~ 50,000[unit:ms]	0	K546	K846	Word
3	Coord.	0 : ABS, 1 : INC	ABS	K5584	K8584	Bit
	Pattern	0 : END, 1 : KEEP, 2 : CONT	END	K5582~83	K8582~83	Bit
	Control	0 : POS, 1 : SPD	POS	K5581	K8581	Bit
	Method	0 : SIN, 1 : REP	SIN	K5580	K8580	Bit
	REP Step	0 ~ 30 (0 ~ 80 for high - end)	0	K559	K859	Word
	Address[pulse]	-2,147,483,648 ~ 2,147,483,647 [pulse]	0	K550	K850	Double word
	M Code	0 ~ 65,535	0	K557	K857	Word
	A/D No.	0 : No.1, 1 : No.2, 2 : No.3, 3 : No.4	0	K5586~87	K8586~87	Bit
	Speed	1 ~ 100,000[pulse/s]	0	K554	K854	Double word
	Dwell	0 ~ 50,000[unit:ms]	0	K556	K856	Word
4	Coord.	0 : ABS, 1 : INC	ABS	K5684	K8684	Bit
	Pattern	0 : END, 1 : KEEP, 2 : CONT	END	K5682~83	K8682~83	Bit
	Control	0 : POS, 1 : SPD	POS	K5681	K8681	Bit
	Method	0 : SIN, 1 : REP	SIN	K5680	K8680	Bit
	REP Step	0 ~ 30 (0 ~ 80 for high - end)	0	K569	K869	Word
	Address[pulse]	-2,147,483,648 ~ 2,147,483,647 [pulse]	0	K560	K860	Double word
	M Code	0 ~ 65,535	0	K567	K867	Word
	A/D No.	0 : No.1, 1 : No.2, 2 : No.3, 3 : No.4	0	K5686~87	K8686~87	Bit
	Speed	1 ~ 100,000[pulse/s]	0	K564	K864	Double word
	Dwell	0 ~ 50,000[unit:ms]	0	K566	K866	Word

## Chapter 9 Positioning Instruction and K area List

Step	Item	Setting range	Initial value	Dedicated K area		Data size
				X axis	Y axis	
5	Coord.	0 : ABS, 1 : INC	ABS	K5784	K8784	Bit
	Pattern	0 : END, 1 : KEEP, 2 : CONT	END	K5782~83	K8782~83	Bit
	Control	0 : POS, 1 : SPD	POS	K5781	K8781	Bit
	Method	0 : SIN, 1 : REP	SIN	K5780	K8780	Bit
	REP Step	0 ~ 30 (0 ~ 80 for high - end)	0	K579	K879	Word
	Address[pulse]	-2,147,483,648 ~ 2,147,483,647 [pulse]	0	K570	K870	Double word
	M Code	0 ~ 65,535	0	K577	K877	Word
	A/D No.	0 : No.1, 1 : No.2, 2 : No.3, 3 : No.4	0	K5786~87	K8786~87	Bit
	Speed	1 ~ 100,000[pulse/s]	0	K574	K874	Double word
	Dwell	0 ~ 50,000[unit:ms]	0	K576	K876	Word
6	Coord.	0 : ABS, 1 : INC	ABS	K5884	K8884	Bit
	Pattern	0 : END, 1 : KEEP, 2 : CONT	END	K5882~83	K8882~83	Bit
	Control	0 : POS, 1 : SPD	POS	K5881	K8881	Bit
	Method	0 : SIN, 1 : REP	SIN	K5880	K8880	Bit
	REP Step	0 ~ 30 (0 ~ 80 for high - end)	0	K589	K889	Word
	Address[pulse]	-2,147,483,648 ~ 2,147,483,647 [pulse]	0	K580	K880	Double word
	M Code	0 ~ 65,535	0	K587	K887	Word
	A/D No.	0 : No.1, 1 : No.2, 2 : No.3, 3 : No.4	0	K5886~87	K8886~87	Bit
	Speed	1 ~ 100,000[pulse/s]	0	K584	K884	Double word
	Dwell	0 ~ 50,000[unit:ms]	0	K586	K886	Word
7	Coord.	0 : ABS, 1 : INC	ABS	K5984	K8984	Bit
	Pattern	0 : END, 1 : KEEP, 2 : CONT	END	K5982~83	K8982~83	Bit
	Control	0 : POS, 1 : SPD	POS	K5981	K8981	Bit
	Method	0 : SIN, 1 : REP	SIN	K5980	K8980	Bit
	REP Step	0 ~ 30 (0 ~ 80 for high - end)	0	K599	K899	Word
	Address[pulse]	-2,147,483,648 ~ 2,147,483,647 [pulse]	0	K590	K890	Double word
	M Code	0 ~ 65,535	0	K597	K897	Word
	A/D No.	0 : No.1, 1 : No.2, 2 : No.3, 3 : No.4	0	K5986~87	K8986~87	Bit
	Speed	1 ~ 100,000[pulse/s]	0	K594	K894	Double word
	Dwell	0 ~ 50,000[unit:ms]	0	K596	K896	Word
8	Coord.	0 : ABS, 1 : INC	ABS	K6084	K9084	Bit
	Pattern	0 : END, 1 : KEEP, 2 : CONT	END	K6082~83	K9082~83	Bit
	Control	0 : POS, 1 : SPD	POS	K6081	K9081	Bit
	Method	0 : SIN, 1 : REP	SIN	K6080	K9080	Bit
	REP Step	0 ~ 30 (0 ~ 80 for high - end)	0	K609	K909	Word
	Address[pulse]	-2,147,483,648 ~ 2,147,483,647 [pulse]	0	K600	K900	Double word
	M Code	0 ~ 65,535	0	K607	K907	Word
	A/D No.	0 : No.1, 1 : No.2, 2 : No.3, 3 : No.4	0	K6086~87	K9086~87	Bit
	Speed	1 ~ 100,000[pulse/s]	0	K604	K904	Double word
	Dwell	0 ~ 50,000[unit:ms]	0	K606	K906	Word

## Chapter 9 Positioning Instruction and K area List

Step	Item	Setting range	Initial value	Dedicated K area		Data size
				X axis	Y axis	
9	Coord.	0 : ABS, 1 : INC	ABS	K6184	K9184	Bit
	Pattern	0 : END, 1 : KEEP, 2 : CONT	END	K6182~83	K9182~83	Bit
	Control	0 : POS, 1 : SPD	POS	K6181	K9181	Bit
	Method	0 : SIN, 1 : REP	SIN	K6180	K9180	Bit
	REP Step	0 ~ 30 (0 ~ 80 for high - end)	0	K619	K919	Word
	Address[pulse]	-2,147,483,648~2,147,483,647 [pulse]	0	K610	K910	Double word
	M Code	0 ~ 65,535	0	K617	K917	Word
	A/D No.	0 : No.1, 1 : No.2, 2 : No.3, 3 : No.4	0	K6186~87	K9186~87	Bit
	Speed	1 ~ 100,000[pulse/s]	0	K614	K914	Double word
	Dwell	0 ~ 50,000[unit:ms]	0	K616	K916	Word
10	Coord.	0 : ABS, 1 : INC	ABS	K6284	K9284	Bit
	Pattern	0 : END, 1 : KEEP, 2 : CONT	END	K6282~83	K9282~83	Bit
	Control	0 : POS, 1 : SPD	POS	K6281	K9281	Bit
	Method	0 : SIN, 1 : REP	SIN	K6280	K9280	Bit
	REP Step	0 ~ 30 (0 ~ 80 for high - end)	0	K629	K929	Word
	Address[pulse]	-2,147,483,648~2,147,483,647 [pulse]	0	K620	K920	Double word
	M Code	0 ~ 65,535	0	K627	K927	Word
	A/D No.	0 : No.1, 1 : No.2, 2 : No.3, 3 : No.4	0	K6286~87	K9286~87	Bit
	Speed	1 ~ 100,000[pulse/s]	0	K624	K924	Double word
	Dwell	0 ~ 50,000[unit:ms]	0	K626	K926	Word
11	Coord.	0 : ABS, 1 : INC	ABS	K6384	K9384	Bit
	Pattern	0 : END, 1 : KEEP, 2 : CONT	END	K6382~83	K9382~83	Bit
	Control	0 : POS, 1 : SPD	POS	K6381	K9381	Bit
	Method	0 : SIN, 1 : REP	SIN	K6380	K9380	Bit
	REP Step	0 ~ 30 (0 ~ 80 for high - end)	0	K639	K939	Word
	Address[pulse]	-2,147,483,648~2,147,483,647 [pulse]	0	K630	K930	Double word
	M Code	0 ~ 65,535	0	K637	K937	Word
	A/D No.	0 : No.1, 1 : No.2, 2 : No.3, 3 : No.4	0	K6386~87	K9386~87	Bit
	Speed	1 ~ 100,000[pulse/s]	0	K634	K934	Double word
	Dwell	0 ~ 50,000[unit:ms]	0	K636	K936	Word
12	Coord.	0 : ABS, 1 : INC	ABS	K6484	K9484	Bit
	Pattern	0 : END, 1 : KEEP, 2 : CONT	END	K6482~83	K9482~83	Bit
	Control	0 : POS, 1 : SPD	POS	K6481	K9481	Bit
	Method	0 : SIN, 1 : REP	SIN	K6480	K9480	Bit
	REP Step	0 ~ 30 (0 ~ 80 for high - end)	0	K649	K949	Word
	Address[pulse]	-2,147,483,648~2,147,483,647 [pulse]	0	K640	K940	Double word
	M Code	0 ~ 65,535	0	K647	K947	Word
	A/D No.	0 : No.1, 1 : No.2, 2 : No.3, 3 : No.4	0	K6486~87	K9486~87	Bit
	Speed	1 ~ 100,000[pulse/s]	0	K644	K944	Double word
	Dwell	0 ~ 50,000[unit:ms]	0	K646	K946	Word

## Chapter 9 Positioning Instruction and K area List

Step	Item	Setting range	Initial value	Dedicated K area		Data size
				X axis	Y axis	
13	Coord.	0 : ABS, 1 : INC	ABS	K6584	K9584	Bit
	Pattern	0 : END, 1 : KEEP, 2 : CONT	END	K6582~83	K9582~83	Bit
	Control	0 : POS, 1 : SPD	POS	K6581	K9581	Bit
	Method	0 : SIN, 1 : REP	SIN	K6580	K9580	Bit
	REP Step	0 ~ 30 (0 ~ 80 for high - end)	0	K659	K959	Word
	Address[pulse]	-2,147,483,648~2,147,483,647 [pulse]	0	K650	K950	Double word
	M Code	0 ~ 65,535	0	K657	K957	Word
	A/D No.	0 : No.1, 1 : No.2, 2 : No.3, 3 : No.4	0	K6586~87	K9586~87	Bit
	Speed	1 ~ 100,000[pulse/s]	0	K654	K954	Double word
	Dwell	0 ~ 50,000[unit:ms]	0	K656	K956	Word
14	Coord.	0 : ABS, 1 : INC	ABS	K6684	K9684	Bit
	Pattern	0 : END, 1 : KEEP, 2 : CONT	END	K6682~83	K9682~83	Bit
	Control	0 : POS, 1 : SPD	POS	K6681	K9681	Bit
	Method	0 : SIN, 1 : REP	SIN	K6680	K9680	Bit
	REP Step	0 ~ 30 (0 ~ 80 for high - end)	0	K669	K969	Word
	Address[pulse]	-2,147,483,648~2,147,483,647 [pulse]	0	K660	K960	Double word
	M Code	0 ~ 65,535	0	K667	K967	Word
	A/D No.	0 : No.1, 1 : No.2, 2 : No.3, 3 : No.4	0	K6686~87	K9686~87	Bit
	Speed	1 ~ 100,000[pulse/s]	0	K664	K964	Double word
	Dwell	0 ~ 50,000[unit:ms]	0	K666	K966	Word
15	Coord.	0 : ABS, 1 : INC	ABS	K6784	K9784	Bit
	Pattern	0 : END, 1 : KEEP, 2 : CONT	END	K6782~83	K9782~83	Bit
	Control	0 : POS, 1 : SPD	POS	K6781	K9781	Bit
	Method	0 : SIN, 1 : REP	SIN	K6780	K9780	Bit
	REP Step	0 ~ 30 (0 ~ 80 for high - end)	0	K679	K979	Word
	Address[pulse]	-2,147,483,648~2,147,483,647 [pulse]	0	K670	K970	Double word
	M Code	0 ~ 65,535	0	K677	K977	Word
	A/D No.	0 : No.1, 1 : No.2, 2 : No.3, 3 : No.4	0	K6786~87	K9786~87	Bit
	Speed	1 ~ 100,000[pulse/s]	0	K674	K974	Double word
	Dwell	0 ~ 50,000[unit:ms]	0	K676	K976	Word
16	Coord.	0 : ABS, 1 : INC	ABS	K6884	K9884	Bit
	Pattern	0 : END, 1 : KEEP, 2 : CONT	END	K6882~83	K9882~83	Bit
	Control	0 : POS, 1 : SPD	POS	K6881	K9881	Bit
	Method	0 : SIN, 1 : REP	SIN	K6880	K9880	Bit
	REP Step	0 ~ 30 (0 ~ 80 for high - end)	0	K689	K989	Word
	Address[pulse]	-2,147,483,648~2,147,483,647 [pulse]	0	K680	K980	Double word
	M Code	0 ~ 65,535	0	K687	K987	Word
	A/D No.	0 : No.1, 1 : No.2, 2 : No.3, 3 : No.4	0	K6886~87	K9886~87	Bit
	Speed	1 ~ 100,000[pulse/s]	0	K684	K984	Double word
	Dwell	0 ~ 50,000[unit:ms]	0	K686	K986	Word

## Chapter 9 Positioning Instruction and K area List

Step	Item	Setting range	Initial value	Dedicated K area		Data size
				X axis	Y axis	
17	Coord.	0 : ABS, 1 : INC	ABS	K6984	K9984	Bit
	Pattern	0 : END, 1 : KEEP, 2 : CONT	END	K6982~83	K9982~83	Bit
	Control	0 : POS, 1 : SPD	POS	K6981	K9981	Bit
	Method	0 : SIN, 1 : REP	SIN	K6980	K9980	Bit
	REP Step	0 ~ 30 (0 ~ 80 for high - end)	0	K699	K999	Word
	Address[pulse]	-2,147,483,648~2,147,483,647 [pulse]	0	K690	K990	Double word
	M Code	0 ~ 65,535	0	K697	K997	Word
	A/D No.	0 : No.1, 1 : No.2, 2 : No.3, 3 : No.4	0	K6986~87	K9986~87	Bit
	Speed	1 ~ 100,000[pulse/s]	0	K694	K994	Double word
	Dwell	0 ~ 50,000[unit:ms]	0	K696	K996	Word
18	Coord.	0 : ABS, 1 : INC	ABS	K7084	K10084	Bit
	Pattern	0 : END, 1 : KEEP, 2 : CONT	END	K7082~83	K10082~83	Bit
	Control	0 : POS, 1 : SPD	POS	K7081	K10081	Bit
	Method	0 : SIN, 1 : REP	SIN	K7080	K10080	Bit
	REP Step	0 ~ 30 (0 ~ 80 for high - end)	0	K709	K1009	Word
	Address[pulse]	-2,147,483,648~2,147,483,647 [pulse]	0	K700	K1000	Double word
	M Code	0 ~ 65,535	0	K707	K1007	Word
	A/D No.	0 : No.1, 1 : No.2, 2 : No.3, 3 : No.4	0	K7086~87	K10086~87	Bit
	Speed	1 ~ 100,000[pulse/s]	0	K704	K1004	Double word
	Dwell	0 ~ 50,000[unit:ms]	0	K706	K1006	Word
19	Coord.	0 : ABS, 1 : INC	ABS	K7184	K10184	Bit
	Pattern	0 : END, 1 : KEEP, 2 : CONT	END	K7182~83	K10182~83	Bit
	Control	0 : POS, 1 : SPD	POS	K7181	K10181	Bit
	Method	0 : SIN, 1 : REP	SIN	K7180	K10180	Bit
	REP Step	0 ~ 30 (0 ~ 80 for high - end)	0	K719	K1019	Word
	Address[pulse]	-2,147,483,648~2,147,483,647 [pulse]	0	K710	K1010	Double word
	M Code	0 ~ 65,535	0	K717	K1017	Word
	A/D No.	0 : No.1, 1 : No.2, 2 : No.3, 3 : No.4	0	K7186~87	K10186~87	Bit
	Speed	1 ~ 100,000[pulse/s]	0	K714	K1014	Double word
	Dwell	0 ~ 50,000[unit:ms]	0	K716	K1016	Word
20	Coord.	0 : ABS, 1 : INC	ABS	K7284	K10284	Bit
	Pattern	0 : END, 1 : KEEP, 2 : CONT	END	K7282~83	K10282~83	Bit
	Control	0 : POS, 1 : SPD	POS	K7281	K10281	Bit
	Method	0 : SIN, 1 : REP	SIN	K7280	K10280	Bit
	REP Step	0 ~ 30 (0 ~ 80 for high - end)	0	K729	K1029	Word
	Address[pulse]	-2,147,483,648~2,147,483,647 [pulse]	0	K720	K1020	Double word
	M Code	0 ~ 65,535	0	K727	K1027	Word
	A/D No.	0 : No.1, 1 : No.2, 2 : No.3, 3 : No.4	0	K7286~87	K10286~87	Bit
	Speed	1 ~ 100,000[pulse/s]	0	K724	K1024	Double word
	Dwell	0 ~ 50,000[unit:ms]	0	K726	K1026	Word



## Chapter 9 Positioning Instruction and K area List

Step	Item	Setting range	Initial value	Dedicated K area		Data size
				X axis	Y axis	
21	Coord.	0 : ABS, 1 : INC	ABS	K7384	K10384	Bit
	Pattern	0 : END, 1 : KEEP, 2 : CONT	END	K7382~83	K10382~83	Bit
	Control	0 : POS, 1 : SPD	POS	K7381	K10381	Bit
	Method	0 : SIN, 1 : REP	SIN	K7380	K10380	Bit
	REP Step	0 ~ 30 (0 ~ 80 for high - end)	0	K739	K1039	Word
	Address[pulse]	-2,147,483,648~2,147,483,647 [pulse]	0	K730	K1030	Double word
	M Code	0 ~ 65,535	0	K737	K1037	Word
	A/D No.	0 : No.1, 1 : No.2, 2 : No.3, 3 : No.4	0	K7386~87	K10386~87	Bit
	Speed	1 ~ 100,000[pulse/s]	0	K734	K1034	Double word
	Dwell	0 ~ 50,000[unit:ms]	0	K736	K1036	Word
22	Coord.	0 : ABS, 1 : INC	ABS	K7484	K10484	Bit
	Pattern	0 : END, 1 : KEEP, 2 : CONT	END	K7482~83	K10482~83	Bit
	Control	0 : POS, 1 : SPD	POS	K7481	K10481	Bit
	Method	0 : SIN, 1 : REP	SIN	K7480	K10480	Bit
	REP Step	0 ~ 30 (0 ~ 80 for high - end)	0	K749	K1049	Word
	Address[pulse]	-2,147,483,648~2,147,483,647 [pulse]	0	K740	K1040	Double word
	M Code	0 ~ 65,535	0	K747	K1047	Word
	A/D No.	0 : No.1, 1 : No.2, 2 : No.3, 3 : No.4	0	K7486~87	K10486~87	Bit
	Speed	1 ~ 100,000[pulse/s]	0	K744	K1044	Double word
	Dwell	0 ~ 50,000[unit:ms]	0	K746	K1046	Word
23	Coord.	0 : ABS, 1 : INC	ABS	K7584	K10584	Bit
	Pattern	0 : END, 1 : KEEP, 2 : CONT	END	K7582~83	K10582~83	Bit
	Control	0 : POS, 1 : SPD	POS	K7581	K10581	Bit
	Method	0 : SIN, 1 : REP	SIN	K7580	K10580	Bit
	REP Step	0 ~ 30 (0 ~ 80 for high - end)	0	K759	K1059	Word
	Address[pulse]	-2,147,483,648~2,147,483,647 [pulse]	0	K750	K1050	Double word
	M Code	0 ~ 65,535	0	K757	K1057	Word
	A/D No.	0 : No.1, 1 : No.2, 2 : No.3, 3 : No.4	0	K7586~87	K10586~87	Bit
	Speed	1 ~ 100,000[pulse/s]	0	K754	K1054	Double word
	Dwell	0 ~ 50,000[unit:ms]	0	K756	K1056	Word
24	Coord.	0 : ABS, 1 : INC	ABS	K7684	K10684	Bit
	Pattern	0 : END, 1 : KEEP, 2 : CONT	END	K7682~83	K10682~83	Bit
	Control	0 : POS, 1 : SPD	POS	K7681	K10681	Bit
	Method	0 : SIN, 1 : REP	SIN	K7680	K10680	Bit
	REP Step	0 ~ 30 (0 ~ 80 for high - end)	0	K769	K1069	Word
	Address[pulse]	-2,147,483,648~2,147,483,647 [pulse]	0	K760	K1060	Double word
	M Code	0 ~ 65,535	0	K767	K1067	Word
	A/D No.	0 : No.1, 1 : No.2, 2 : No.3, 3 : No.4	0	K7686~87	K10686~87	Bit
	Speed	1 ~ 100,000[pulse/s]	0	K764	K1064	Double word
	Dwell	0 ~ 50,000[unit:ms]	0	K766	K1066	Word

## Chapter 9 Positioning Instruction and K area List

Step	Item	Setting range	Initial value	Dedicated K area		Data size
				X axis	Y axis	
25	Coord.	0 : ABS, 1 : INC	ABS	K7784	K10784	Bit
	Pattern	0 : END, 1 : KEEP, 2 : CONT	END	K7782~83	K10782~83	Bit
	Control	0 : POS, 1 : SPD	POS	K7781	K10781	Bit
	Method	0 : SIN, 1 : REP	SIN	K7780	K10780	Bit
	REP Step	0 ~ 30 (0 ~ 80 for high - end)	0	K779	K1079	Word
	Address[pulse]	-2,147,483,648~2,147,483,647 [pulse]	0	K770	K1070	Double word
	M Code	0 ~ 65,535	0	K777	K1077	Word
	A/D No.	0 : No.1, 1 : No.2, 2 : No.3, 3 : No.4	0	K7786~87	K10786~87	Bit
	Speed	1 ~ 100,000[pulse/s]	0	K774	K1074	Double word
	Dwell	0 ~ 50,000[unit:ms]	0	K776	K1076	Word
26	Coord.	0 : ABS, 1 : INC	ABS	K7884	K10884	Bit
	Pattern	0 : END, 1 : KEEP, 2 : CONT	END	K7882~83	K10882~83	Bit
	Control	0 : POS, 1 : SPD	POS	K7881	K10881	Bit
	Method	0 : SIN, 1 : REP	SIN	K7880	K10880	Bit
	REP Step	0 ~ 30 (0 ~ 80 for high - end)	0	K789	K1089	Word
	Address[pulse]	-2,147,483,648~2,147,483,647 [pulse]	0	K780	K1080	Double word
	M Code	0 ~ 65,535	0	K787	K1087	Word
	A/D No.	0 : No.1, 1 : No.2, 2 : No.3, 3 : No.4	0	K7886~87	K10886~87	Bit
	Speed	1 ~ 100,000[pulse/s]	0	K784	K1084	Double word
	Dwell	0 ~ 50,000[unit:ms]	0	K786	K1086	Word
27	Coord.	0 : ABS, 1 : INC	ABS	K7984	K10984	Bit
	Pattern	0 : END, 1 : KEEP, 2 : CONT	END	K7982~83	K10982~83	Bit
	Control	0 : POS, 1 : SPD	POS	K7981	K10981	Bit
	Method	0 : SIN, 1 : REP	SIN	K7980	K10980	Bit
	REP Step	0 ~ 30 (0 ~ 80 for high - end)	0	K799	K1099	Word
	Address[pulse]	-2,147,483,648~2,147,483,647 [pulse]	0	K790	K1090	Double word
	M Code	0 ~ 65,535	0	K797	K1097	Word
	A/D No.	0 : No.1, 1 : No.2, 2 : No.3, 3 : No.4	0	K7986~87	K10986~87	Bit
	Speed	1 ~ 100,000[pulse/s]	0	K794	K1094	Double word
	Dwell	0 ~ 50,000[unit:ms]	0	K796	K1096	Word
28	Coord.	0 : ABS, 1 : INC	ABS	K8084	K11084	Bit
	Pattern	0 : END, 1 : KEEP, 2 : CONT	END	K8082~83	K11082~83	Bit
	Control	0 : POS, 1 : SPD	POS	K8081	K11081	Bit
	Method	0 : SIN, 1 : REP	SIN	K8080	K11080	Bit
	REP Step	0 ~ 30 (0 ~ 80 for high - end)	0	K809	K1109	Word
	Address[pulse]	-2,147,483,648~2,147,483,647 [pulse]	0	K800	K1100	Double word
	M Code	0 ~ 65,535	0	K807	K1107	Word
	A/D No.	0 : No.1, 1 : No.2, 2 : No.3, 3 : No.4	0	K8086~87	K11086~87	Bit
	Speed	1 ~ 100,000[pulse/s]	0	K804	K1104	Double word
	Dwell	0 ~ 50,000[unit:ms]	0	K806	K1106	Word

## Chapter 9 Positioning Instruction and K area List

Step	Item	Setting range	Initial value	Dedicated K area		Data size
				X axis	Y axis	
29	Coord.	0 : ABS, 1 : INC	ABS	K8184	K11184	Bit
	Pattern	0 : END, 1 : KEEP, 2 : CONT	END	K8182~83	K11182~83	Bit
	Control	0 : POS, 1 : SPD	POS	K8181	K11181	Bit
	Method	0 : SIN, 1 : REP	SIN	K8180	K11180	Bit
	REP Step	0 ~ 30 (0 ~ 80 for high - end)	0	K819	K1119	Word
	Address[pulse]	-2,147,483,648~2,147,483,647 [pulse]	0	K810	K1110	Double word
	M Code	0 ~ 65,535	0	K817	K1117	Word
	A/D No.	0 : No.1, 1 : No.2, 2 : No.3, 3 : No.4	0	K8186~87	K11186~87	Bit
	Speed	1 ~ 100,000[pulse/s]	0	K814	K1114	Double word
	Dwell	0 ~ 50,000[unit:ms]	0	K816	K1116	Word
30	Coord.	0 : ABS, 1 : INC	ABS	K8284	K11284	Bit
	Pattern	0 : END, 1 : KEEP, 2 : CONT	END	K8282~83	K11282~83	Bit
	Control	0 : POS, 1 : SPD	POS	K8281	K11281	Bit
	Method	0 : SIN, 1 : REP	SIN	K8280	K11280	Bit
	REP Step	0 ~ 30 (0 ~ 80 for high - end)	0	K829	K1129	Word
	Address[pulse]	-2,147,483,648~2,147,483,647 [pulse]	0	K820	K1120	Double word
	M Code	0 ~ 65,535	0	K827	K1127	Word
	A/D No.	0 : No.1, 1 : No.2, 2 : No.3, 3 : No.4	0	K8286~87	K11286~87	Bit
	Speed	1 ~ 100,000[pulse/s]	0	K824	K1124	Double word
	Dwell	0 ~ 50,000[unit:ms]	0	K826	K1126	Word
31	Coord.	0 : ABS, 1 : INC	ABS	K23484	K28484	Bit
	Pattern	0 : END, 1 : KEEP, 2 : CONT	END	K23482~83	K28482~83	Bit
	Control	0 : POS, 1 : SPD	POS	K23481	K28481	Bit
	Method	0 : SIN, 1 : REP	SIN	K23480	K28480	Bit
	REP Step	0 ~ 30 (0 ~ 80 for high - end)	0	K2349	K2849	Word
	Address[pulse]	-2,147,483,648~2,147,483,647 [pulse]	0	K2340	K2840	Double word
	M Code	0 ~ 65,535	0	K2347	K2847	Word
	A/D No.	0 : No.1, 1 : No.2, 2 : No.3, 3 : No.4	0	K23486~87	K28486~87	Bit
	Speed	1 ~ 100,000[pulse/s]	0	K2344	K2844	Double word
	Dwell	0 ~ 50,000[unit:ms]	0	K2346	K2846	Word
32	Coord.	0 : ABS, 1 : INC	ABS	K23584	K28584	Bit
	Pattern	0 : END, 1 : KEEP, 2 : CONT	END	K23582~83	K28582~83	Bit
	Control	0 : POS, 1 : SPD	POS	K23581	K28581	Bit
	Method	0 : SIN, 1 : REP	SIN	K23580	K28580	Bit
	REP Step	0 ~ 30 (0 ~ 80 for high - end)	0	K2359	K2859	Word
	Address[pulse]	-2,147,483,648~2,147,483,647 [pulse]	0	K2350	K2850	Double word
	M Code	0 ~ 65,535	0	K2357	K2857	Word
	A/D No.	0 : No.1, 1 : No.2, 2 : No.3, 3 : No.4	0	K23586~87	K28586~87	Bit
	Speed	1 ~ 100,000[pulse/s]	0	K2354	K2854	Double word
	Dwell	0 ~ 50,000[unit:ms]	0	K2356	K2856	Word

## Chapter 9 Positioning Instruction and K area List

Step	Item	Setting range	Initial value	Dedicated K area		Data size
				X axis	Y axis	
33	Coord.	0 : ABS, 1 : INC	ABS	K23684	K28684	Bit
	Pattern	0 : END, 1 : KEEP, 2 : CONT	END	K23682~83	K28682~83	Bit
	Control	0 : POS, 1 : SPD	POS	K23681	K28681	Bit
	Method	0 : SIN, 1 : REP	SIN	K23680	K28680	Bit
	REP Step	0 ~ 30 (0 ~ 80 for high - end)	0	K2369	K2869	Word
	Address[pulse]	-2,147,483,648~2,147,483,647 [pulse]	0	K2360	K2860	Double word
	M Code	0 ~ 65,535	0	K2367	K2867	Word
	A/D No.	0 : No.1, 1 : No.2, 2 : No.3, 3 : No.4	0	K23686~87	K28686~87	Bit
	Speed	1 ~ 100,000[pulse/s]	0	K2364	K2864	Double word
	Dwell	0 ~ 50,000[unit:ms]	0	K2366	K2866	Word
34	Coord.	0 : ABS, 1 : INC	ABS	K23784	K28784	Bit
	Pattern	0 : END, 1 : KEEP, 2 : CONT	END	K23782~83	K28782~83	Bit
	Control	0 : POS, 1 : SPD	POS	K23781	K28781	Bit
	Method	0 : SIN, 1 : REP	SIN	K23780	K28780	Bit
	REP Step	0 ~ 30 (0 ~ 80 for high - end)	0	K2379	K2879	Word
	Address[pulse]	-2,147,483,648~2,147,483,647 [pulse]	0	K2370	K2870	Double word
	M Code	0 ~ 65,535	0	K2377	K2877	Word
	A/D No.	0 : No.1, 1 : No.2, 2 : No.3, 3 : No.4	0	K23786~87	K28786~87	Bit
	Speed	1 ~ 100,000[pulse/s]	0	K2374	K2874	Double word
	Dwell	0 ~ 50,000[unit:ms]	0	K2376	K2876	Word
35	Coord.	0 : ABS, 1 : INC	ABS	K23884	K28884	Bit
	Pattern	0 : END, 1 : KEEP, 2 : CONT	END	K23882~83	K28882~83	Bit
	Control	0 : POS, 1 : SPD	POS	K23881	K28881	Bit
	Method	0 : SIN, 1 : REP	SIN	K23880	K28880	Bit
	REP Step	0 ~ 30 (0 ~ 80 for high - end)	0	K2389	K2889	Word
	Address[pulse]	-2,147,483,648~2,147,483,647 [pulse]	0	K2380	K2880	Double word
	M Code	0 ~ 65,535	0	K2387	K2887	Word
	A/D No.	0 : No.1, 1 : No.2, 2 : No.3, 3 : No.4	0	K23886~87	K28886~87	Bit
	Speed	1 ~ 100,000[pulse/s]	0	K2384	K2884	Double word
	Dwell	0 ~ 50,000[unit:ms]	0	K2386	K2886	Word
36	Coord.	0 : ABS, 1 : INC	ABS	K23984	K28984	Bit
	Pattern	0 : END, 1 : KEEP, 2 : CONT	END	K23982~83	K28982~83	Bit
	Control	0 : POS, 1 : SPD	POS	K23981	K28981	Bit
	Method	0 : SIN, 1 : REP	SIN	K23980	K28980	Bit
	REP Step	0 ~ 30 (0 ~ 80 for high - end)	0	K2399	K2899	Word
	Address[pulse]	-2,147,483,648~2,147,483,647 [pulse]	0	K2390	K2890	Double word
	M Code	0 ~ 65,535	0	K2397	K2897	Word
	A/D No.	0 : No.1, 1 : No.2, 2 : No.3, 3 : No.4	0	K23986~87	K28986~87	Bit
	Speed	1 ~ 100,000[pulse/s]	0	K2394	K2894	Double word
	Dwell	0 ~ 50,000[unit:ms]	0	K2396	K2896	Word

## Chapter 9 Positioning Instruction and K area List

Step	Item	Setting range	Initial value	Dedicated K area		Data size
				X axis	Y axis	
37	Coord.	0 : ABS, 1 : INC	ABS	K24084	K29084	Bit
	Pattern	0 : END, 1 : KEEP, 2 : CONT	END	K24082~83	K29082~83	Bit
	Control	0 : POS, 1 : SPD	POS	K24081	K29081	Bit
	Method	0 : SIN, 1 : REP	SIN	K24080	K29080	Bit
	REP Step	0 ~ 30 (0 ~ 80 for high - end)	0	K2409	K2909	Word
	Address[pulse]	-2,147,483,648~2,147,483,647 [pulse]	0	K2400	K2900	Double word
	M Code	0 ~ 65,535	0	K2407	K2907	Word
	A/D No.	0 : No.1, 1 : No.2, 2 : No.3, 3 : No.4	0	K24086~87	K29086~87	Bit
	Speed	1 ~ 100,000[pulse/s]	0	K2404	K2904	Double word
	Dwell	0 ~ 50,000[unit:ms]	0	K2406	K2906	Word
38	Coord.	0 : ABS, 1 : INC	ABS	K24184	K29184	Bit
	Pattern	0 : END, 1 : KEEP, 2 : CONT	END	K24182~83	K29182~83	Bit
	Control	0 : POS, 1 : SPD	POS	K24181	K29181	Bit
	Method	0 : SIN, 1 : REP	SIN	K24180	K29180	Bit
	REP Step	0 ~ 30 (0 ~ 80 for high - end)	0	K2419	K2919	Word
	Address[pulse]	-2,147,483,648~2,147,483,647 [pulse]	0	K2410	K2910	Double word
	M Code	0 ~ 65,535	0	K2417	K2917	Word
	A/D No.	0 : No.1, 1 : No.2, 2 : No.3, 3 : No.4	0	K24186~87	K29186~87	Bit
	Speed	1 ~ 100,000[pulse/s]	0	K2414	K2914	Double word
	Dwell	0 ~ 50,000[unit:ms]	0	K2416	K2916	Word
39	Coord.	0 : ABS, 1 : INC	ABS	K24284	K29284	Bit
	Pattern	0 : END, 1 : KEEP, 2 : CONT	END	K24282~83	K29282~83	Bit
	Control	0 : POS, 1 : SPD	POS	K24281	K29281	Bit
	Method	0 : SIN, 1 : REP	SIN	K24280	K29280	Bit
	REP Step	0 ~ 30 (0 ~ 80 for high - end)	0	K2429	K2929	Word
	Address[pulse]	-2,147,483,648~2,147,483,647 [pulse]	0	K2420	K2920	Double word
	M Code	0 ~ 65,535	0	K2427	K2927	Word
	A/D No.	0 : No.1, 1 : No.2, 2 : No.3, 3 : No.4	0	K24286~87	K29286~87	Bit
	Speed	1 ~ 100,000[pulse/s]	0	K2424	K2924	Double word
	Dwell	0 ~ 50,000[unit:ms]	0	K2426	K2926	Word
40	Coord.	0 : ABS, 1 : INC	ABS	K24384	K29384	Bit
	Pattern	0 : END, 1 : KEEP, 2 : CONT	END	K24382~83	K29382~83	Bit
	Control	0 : POS, 1 : SPD	POS	K24381	K29381	Bit
	Method	0 : SIN, 1 : REP	SIN	K24380	K29380	Bit
	REP Step	0 ~ 30 (0 ~ 80 for high - end)	0	K2439	K2939	Word
	Address[pulse]	-2,147,483,648~2,147,483,647 [pulse]	0	K2430	K2930	Double word
	M Code	0 ~ 65,535	0	K2437	K2937	Word
	A/D No.	0 : No.1, 1 : No.2, 2 : No.3, 3 : No.4	0	K24386~87	K29386~87	Bit
	Speed	1 ~ 100,000[pulse/s]	0	K2434	K2934	Double word
	Dwell	0 ~ 50,000[unit:ms]	0	K2436	K2936	Word

## Chapter 10 Motor Wiring Example

### 10.1 Stepping Motor Wiring Example

Here describes wiring example between XGB and stepping motor.

In case of using stepping motor not described here, refer to relevant driver's user manual.

#### (1) Connection to a stepping motor driver (DC5V Power)

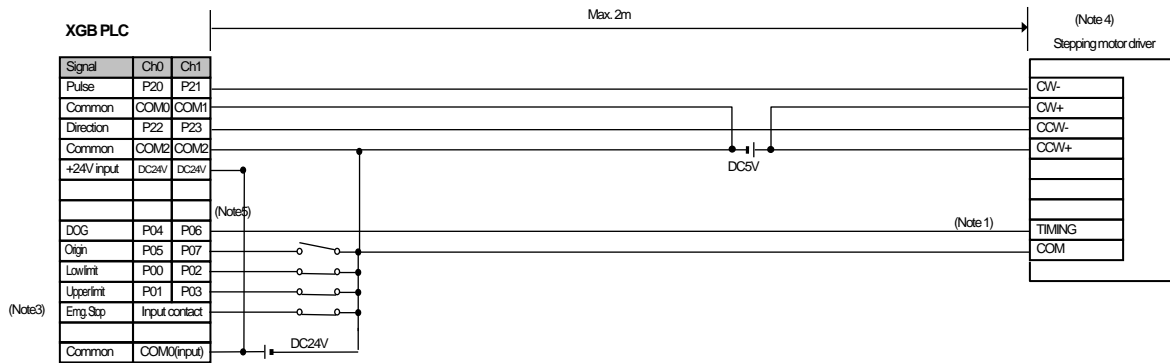

#### (2) Connection to a stepping motor driver (DC24V Power)

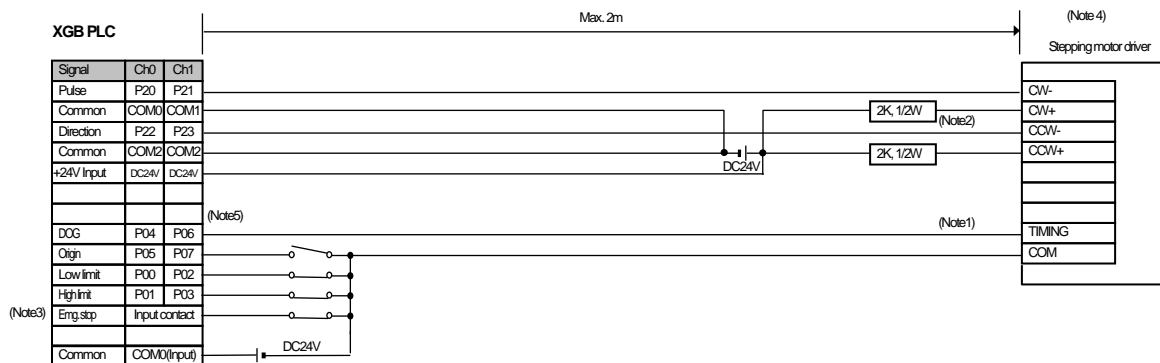

(Note1) In case of VEXTA PKD, timing output is on every time a motor rotates 7.2 degrees. For precise home return, timing output and origin sensor should be structured by AND circuit. Depending on a system's features, it is recommended to use **home return only by DOG signal or origin sensor by origin signal** (XGB origin input rating is DC 24V).

(Note2) Connect resistors suitable for the driver in series if DC24V is used.

(Note3) Although origin, DOC, upper/lower limit signals are with fixed contact, it may be used for general input if they are not used. Emergency stop is available by the command (EMG).

(Note4) In case of XGB standard type, since only pulse + direction mode is available, change input mode of stepping motor driver to 1 phase input mode.

(Note 5) The above figure is example of XGB standard type. For high-end type, Origin, DOG, upper/lower limit input contact point is different with standard type.

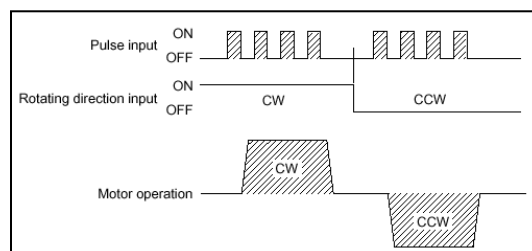

## 10.2 Servo Motor Wiring Example

Here describes wiring example between XGB and servo motor.

In case of using servo motor not described here, refer to relevant driver's user manual.

### (1) Connection to a servo motor driver (MR-J2/J2S-□A)

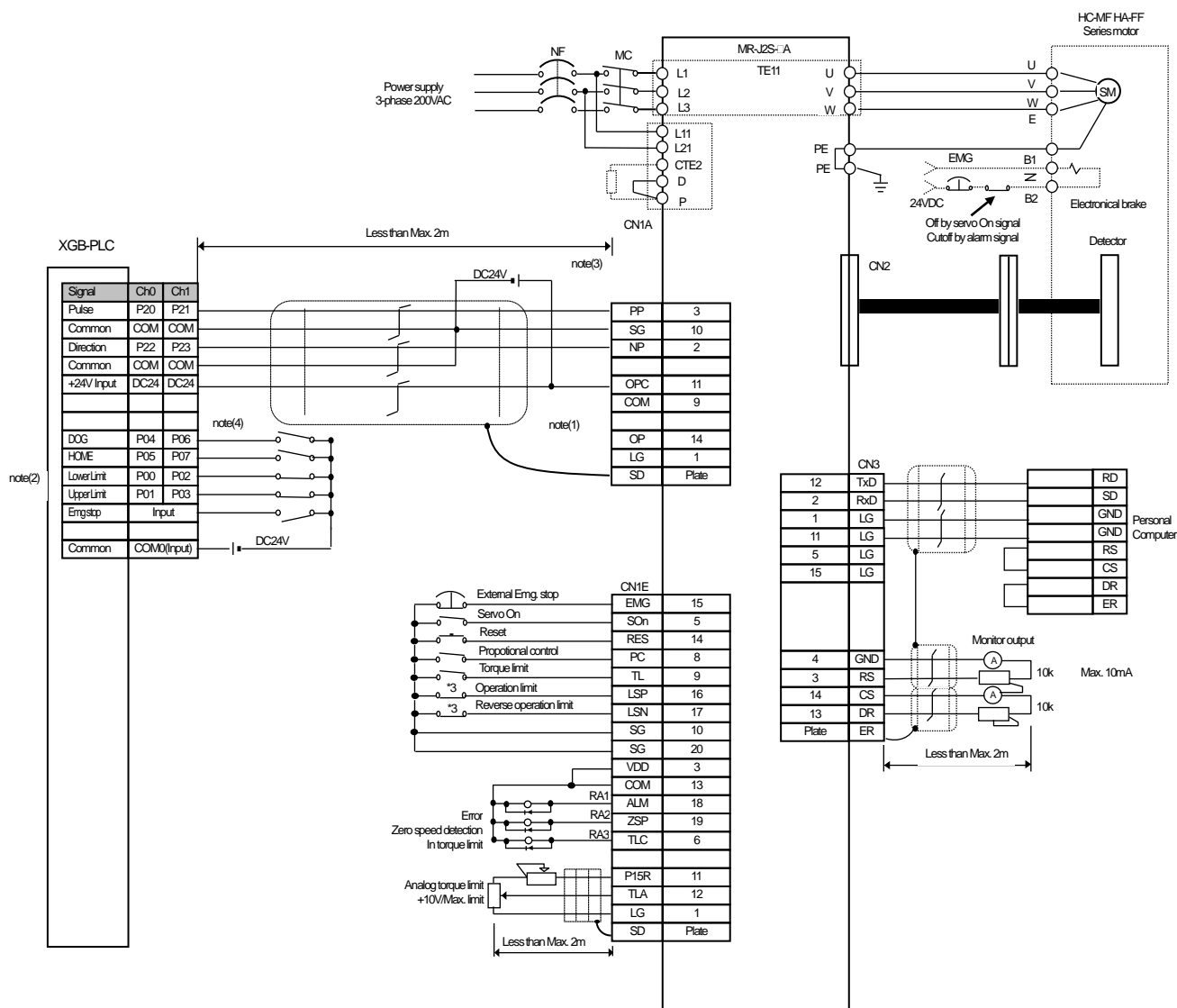

(Note1) The rating of XGB origin input is DC24V. Make sure to connect the open collector output of a driver.

(Note2) Although origin, DOG, upper/lower limit signals are with fixed contact, it may be used for general input if they are not used. Emergency stop is available by the command (EMG).

(Note3) In case of XGB standard type, since only pulse + direction mode is available, change input mode of servo motor driver to 1 phase input mode.

(Note4) The above figure is example of XGB standard type. For high-end type, Origin, DOG, upper/lower limit input contact point is different with standard type.

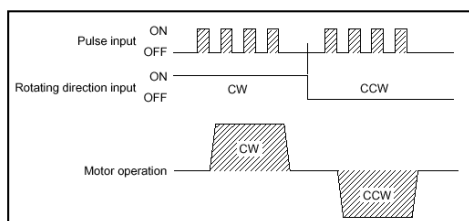

## Chapter 10 Motor Wiring Example

## (2) Connection to a servo motor driver (FDA-5000 AC Servo Driver)

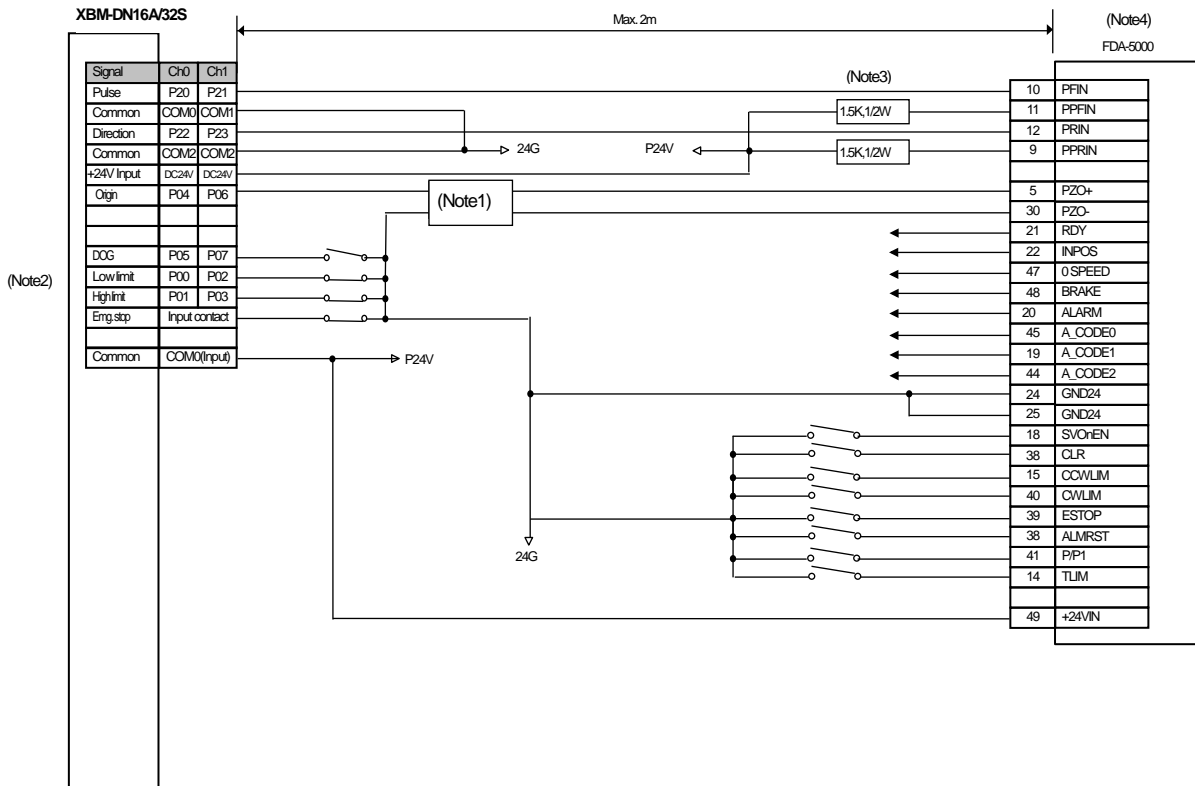

(Note1) The rating of XGB is 24VDC. If it is line driver output, contact is not connected. In the case, use a convert from line driver output to open collector output or use home return only by DOG signal/origin sensor of origin signal.

(Note2) Although origin, DOG, upper/lower limit signals are with fixed contact, it may be used for general input if they are not used. Emergency stop is available by the command (EMG).

(Note3) If using DC24V, make sure to connect resistor suitable for a driver (1.5K, 1/2W) in series.

(Note4) Since the positioning pulse of XGB forward/reverse-rotates by the rotation direction as in the below figure, make sure to change the input mode of a servo motor driver into 1 phase input mode prior to use.

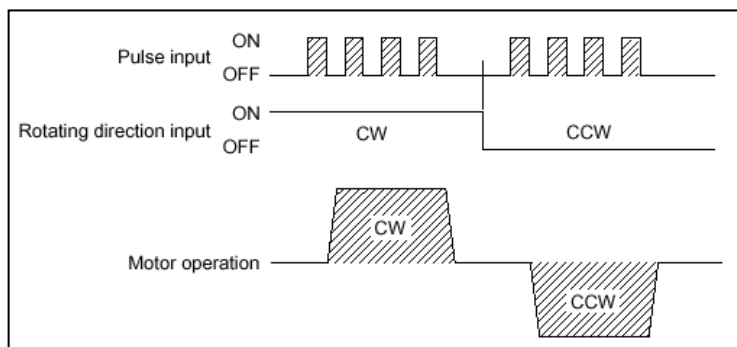



## (3) Connection to a servo motor driver (XGT Servo XDA-S)

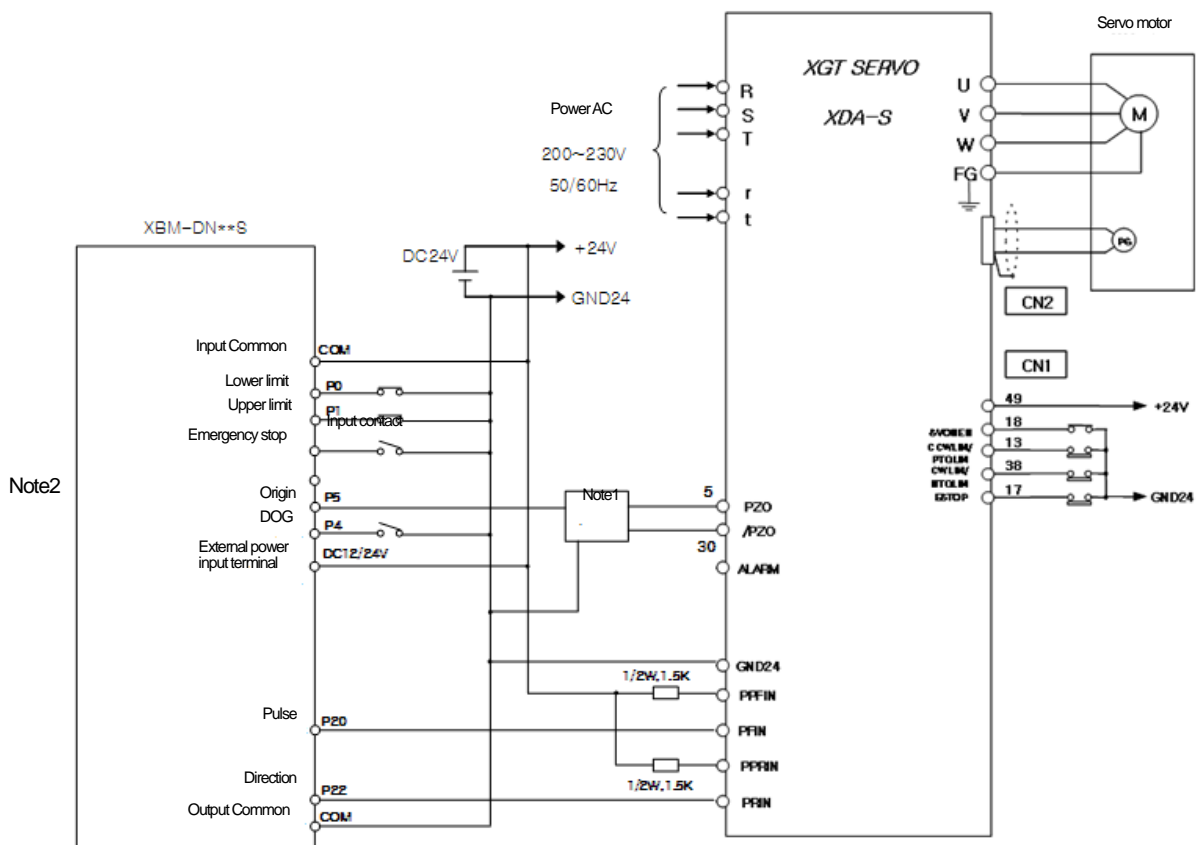

(Note1) The rating of Origin input for XGB stand type is 24VDC. If it is line driver output, contact can't be connected. In the case, use a convert from line driver output to open collector output or use home return only by DOG signal/origin sensor of origin signal.

(Note2) Although origin, DOG, upper/lower limit signals are with fixed contact, it may be used for general input if they are not used. Emergency stop is available by the command (EMG).

(Note3) The above wiring is applied when P07-01=27(positioning mode)

(Note4) Since only pulse + direction mode is available for XGB standard type, make sure to change the input mode of a servo motor driver into pulse + direction mode prior to use

(Note5) In the above wiring, Axis X of XGB standard built-in positioning is used.

(4) Connection to a servo motor driver (XGT Servo XDL-S)

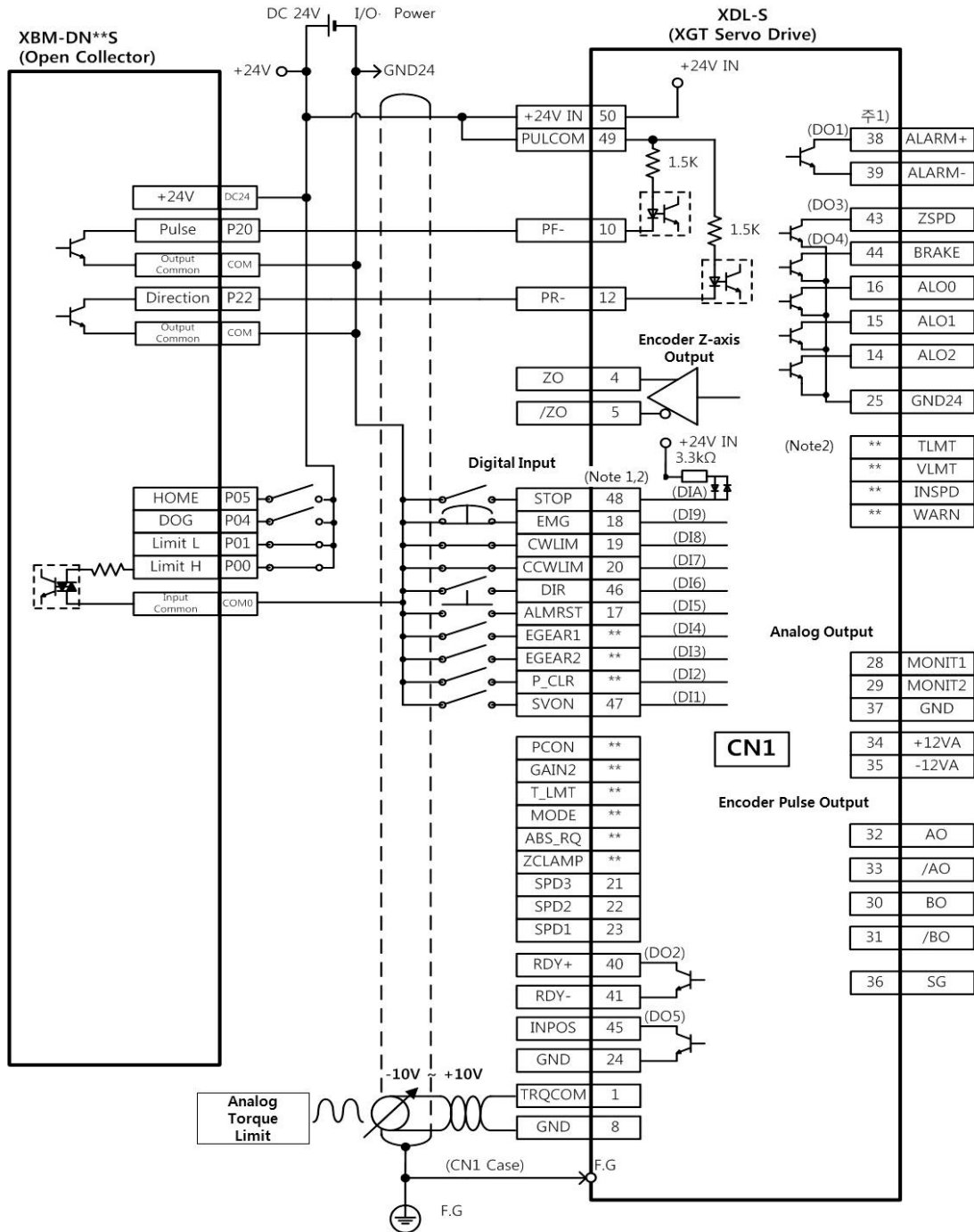

※ This picture is based on 1-axis. For more information about 2-axis wiring, refer to pin information.

(Note1) Input Signal DI1~DIA, Output Signal DO1~DO5 is assigned initial signal from factory shipment

(Note2) \*\* Not assigned Signal. Allocation can be changed by setting servo parameter



---

## Part 4 Communication

---

Part 5. Built-in communication functions describes the specifications, performance and operation methods of 2port FEnet and RS-232C, RS-485 communication, Web server function embedded in XGB high performance small-sized PLC basic unit.

### Chapter 1 Built-in FEnet communication

#### 1.1 Outline

Ethernet is the international standard registered to IEEE (Institute of Electrical and Electronics Engineers), which controls data transfer through CSMA/CD (Carrier Sense Multiple Access/Collision Detection).

Ethernet can transmit data at the speed of 10 Mbps and 100 Mbps and it is stated as 'Fast Ethernet' in the standard. The speed of Fast Ethernet can be expressed as 10 BASE-T, 100 BASE-T. 'T' means the twisted pair wire. In the case of 100 BASE-T, for stable communication with high speed, the specification of the cable to be used is defined and standardized cables are recommended.

The built-in FEnet of XGB high performance small-sized PLC basic unit has various applications based on the standard so it provides excellent functions and performance for a user.

#### Notice

This chapter describes the functions of 2 ports FEnet embedded in XGB high performance small-sized PLC basic unit. For expansion communication modules, refer to the manual of each module.

#### 1.1.1 Characteristics

XGB high performance basic unit's built-in FEnet provides 2 ports with a switch so a user can easily configure various topologies without other devices. In addition, it supports the FTP (File Transfer Protocol) function and you can access to the SD card through FTP to download the file.

The built-in FEnet's main characteristics are as below.

- 1) Supporting IEEE 802.3u standard
- 2) Supporting high speed link for high-speed data communication between LS ELECTRIC modules
  - Providing the parameter setting program (XG5000)
  - Transmission of the maximum 32 blocks X 200 words, reception of the maximum 32 blocks X 200 words, transmission/reception of maximum 64 blocks X 200 words)
- 3) 16 modules and communications are maximally available apart from the high speed link.
- 4) Supporting the loader service (XG5000) through Ethernet
  - Dedicated TCP/IP PORT: 2002 allocations

- 5) Easy connection with other companies' systems through P2P communication and XG5000
  - Variable READ/WRITE service is available: Using the Dynamic Connection functions
- 6) Auto Negotiation
  - Supporting 10/100BASE-TX media auto setting
- 7) Auto-MDIX (Using HP Auto-MDIX)
  - Function to assort the cross cable and straight cable automatically
- 8) Supporting the SD card access through FTP
  - You can download the data log file through FTP client in a remote site.
- 9) 2 ports interface with a built-in switch
  - Line topology configuration is available.
  - Supporting the Auto-Forwarding function
- 10) Supporting various communication functions
  - System access through public network
  - Supporting LS ELECTRIC protocol (XGT) and other companies' protocols (Modbus TCP/IP) (dedicated service)
  - Supporting the simple and convenient client function for communication between LS ELECTRIC communication modules and communication with other companies' modules
  - XGT, Modbus TCP, user-defined P2P client function
  - Providing the host Enable table for upper PC (MMI) and communication security
  - Supporting Dynamic Connection/Disconnection through P2P service

## 1.2 Specifications

### 1.2.1 Performance Specifications

#### 1) Transmission Specifications

Items		Specifications	Remarks
Transmission specifications	Transfer rate	Auto/10Mbps/100Mbps	
	Transfer mode	Base band	
	Flow control	HALF/FULL	
	Modulation method	NRZI	4B/5B coding
	Transformer CT	1:1	node- hub
	Maximum distance between nodes	100 m	
	Maximum segment length	-	
	Maximum number of nodes	Hub access	
	Node distance	-	
	Maximum protocol size	Data 512 bytes	
	Communication zone access method	CSMA/CD	
	Frame error check	CRC 32	
	Communication channel	1 Channel, 2 Port	
Ethernet switch	Unmanaged Switch built-in		

#### 2) Maximum number of channels

Items	Specifications	Remarks
Maximum server access channel	7 channels	XGT dedicated or Modbus: 4 channels Remote 1/2-stage: 1channel(independently) FTP: 1 channel

#### 3) Performance specifications by communication service

Items		Specifications			Remarks
		Driver	Communication method	Port No.	
FUNCTION	Dedicated	XGT server	TCP/IP	2004	<ul style="list-style-type: none"> <li>▪ Up to 4 channels</li> <li>▪ Up to 512 bytes</li> </ul>
			UDP/IP	2005	
		Modbus TCP server	TCP/IP	502	
	High speed link	-	UDP/IP	2006	<ul style="list-style-type: none"> <li>▪ Up to 64 blocks</li> <li>▪ 200 words per block</li> </ul>
	P2P	XGT client	TCP/IP	2004	<ul style="list-style-type: none"> <li>▪ Up to 3 channels</li> <li>▪ Up to 512 bytes</li> </ul>
			UDP/IP	2005	
		Modbus TCP client	TCP/IP	502	
		User-defined frame	TCP/IP	Customized	
	Remote	Server	TCP/IP	2002	<ul style="list-style-type: none"> <li>▪ Up to 1channel</li> </ul>
		Client	TCP/IP	2002	<ul style="list-style-type: none"> <li>▪ Up to 1channel</li> </ul>
Auto Scan	-	UDP/IP	2007,2008	<ul style="list-style-type: none"> <li>▪ Up to 2channel</li> </ul>	
SNTP	Client	UDP/IP	Customized	<ul style="list-style-type: none"> <li>▪Up to 1channel</li> </ul>	
SMTP	Client	TCP/IP	25(relay) Customized	<ul style="list-style-type: none"> <li>▪Up to 2channel</li> </ul>	

4) Performance specifications of diagnosis function

Items		Specifications
Diagnosis function	Information of built-in communication functions	
	Status by service	Dedicated service
		High speed link
		P2Pservice
	Media information	Total number of received packets
		Packet rate per second
	Ping Test	
	Auto-Scan	

5) Available PLC Area

(1) XBC Series(MK type)

AREA	Device Type	Size(Word)	Remark
P	P0 – P2047	2048	Read, Write Enable
M	M0 – M2047	2048	Read, Write Enable
K	K0 – K8191	8192	Read, Write Enable
F	F0 – F219	200	Read Enable
	F200 – F2047	1848	Read, Write Enable
T	T0 – T2047	2048	Read, Write Enable
C	C0 – C2047	2048	Read, Write Enable
L	L0 – L4095	4096	Read, Write Enable
N	N0 – N10239	10240	Read Enable
D	D0 – D19999	20000	Read, Write Enable
U	U00.00 – U0B.31	384	Read, Write Enable
Z	Z0 – Z127	128	Read, Write Enable
R	R0 – R16383	16384	Read, Write Enable

### 1.2.2 Names and roles of built-in FENet parts

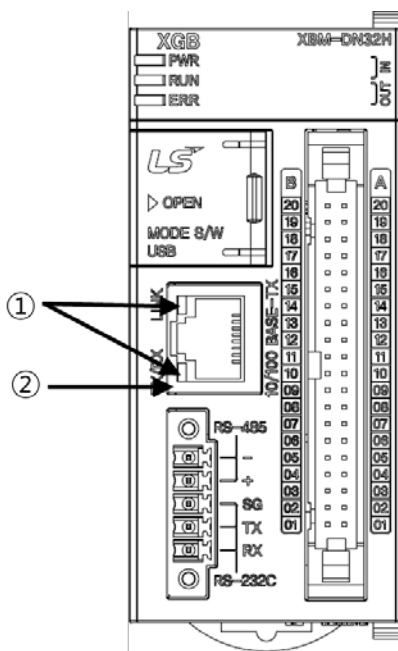

No.	Name	Details																								
①	LED display part	Displays the status of modules and communication.																								
		<table border="1"> <thead> <tr> <th>Item</th> <th>Color</th> <th colspan="3">Operation details of each status</th> </tr> </thead> <tbody> <tr> <td rowspan="3">LINK/ACT</td> <td rowspan="3">Yellow</td> <td>ON</td> <td>Normal connection</td> <td>Linked with the connected device normally</td> </tr> <tr> <td>OFF</td> <td>Connection error</td> <td>No connected device</td> </tr> <tr> <td>Flickering</td> <td>During communication</td> <td>Flickering in case RX, TX occur</td> </tr> <tr> <td rowspan="2">SPEED</td> <td rowspan="2">Green</td> <td>ON</td> <td>100BASE-T</td> <td>In progress at 100Mbps</td> </tr> <tr> <td>OFF</td> <td>10BASE-T</td> <td>In progress at 10Mbps</td> </tr> </tbody> </table>	Item	Color	Operation details of each status			LINK/ACT	Yellow	ON	Normal connection	Linked with the connected device normally	OFF	Connection error	No connected device	Flickering	During communication	Flickering in case RX, TX occur	SPEED	Green	ON	100BASE-T	In progress at 100Mbps	OFF	10BASE-T	In progress at 10Mbps
		Item	Color	Operation details of each status																						
		LINK/ACT	Yellow	ON	Normal connection	Linked with the connected device normally																				
OFF	Connection error			No connected device																						
Flickering	During communication			Flickering in case RX, TX occur																						
SPEED	Green	ON	100BASE-T	In progress at 100Mbps																						
		OFF	10BASE-T	In progress at 10Mbps																						
②	FENet communication connector	FENet communication connector (RJ 45)																								



### 1.2.3 Cable Specifications

#### 1) Classification of cables

For 100 BASE-TX, 'T' indicates 'a twisted wire is applied' and 'X' indicates the kinds of twisted wires for classification. 'TX' uses an unshielded twisted pair wire 5 (UTP 5) or shielded twisted pair wire ; 'T2' uses an unshielded twisted pair wire 3 (UTP 3); 'T4' uses the unshielded twisted pair wire 3, 4, 5 (UTP 3, 4, 5). The built-in FEnet specifies 100 BASE-TX and adopts the UTP cables of more than Category 5. The cables can be classified as below.

Items	Names	Remarks
UTP (or U.UTP)	Cable for unshielded high speed signal	Up to 200MHz Sound + information (Data)+low-grade video signal
FTP (or S.UTP)	Cable with shielded core only	Up to 100MHz Considering electromagnetic interference (EMI) and electronic stability Sound + information (Data)+low-grade video signal
STP (or S.STP)	Dual Shielded, pair individual twisted and cable with shield core only	Up to 500MHz Sound + information (Data)+Video signal Substitute for the coaxial cable of 75Ω

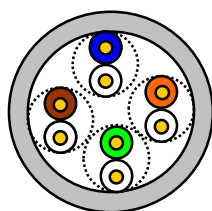

-UTP-

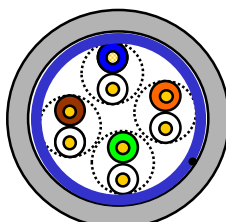

-FTP-

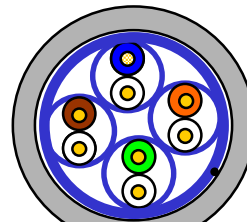

-STP-

#### Notice

XGB FEnet does not support AUI (10BASE-5).

- (1) In the case of twisted pair cable unit (more than Category 5) adopts the hub of 100Mbps and it can be used with the zone of 10Mbps (less than Category3) but at this time, the network speed is limited to 10Mbps so be careful for system installation.
- (2) Both twisted cables and straight cables can be applied.
- (3) UTP : Unshielded Twisted Paired Copper Cable
  - FTP : (Overall) Foiled Twisted Paired Copper Cable
  - STP : (Overall) Shielded (and Shielded Individually Pair)Twisted Paired Copper Cable
- (4) Patch Cable (or Patch Cord)

In order to enhance the UTP 4-paired cable's flexibility, the conductor with twisted wire can be used instead of a solid conductor; used standard specification and material is Un-coated AWG 24 (7/0203A). Namely, the diameter of an element wire is 0.203mm and the element wire is standardized with the structure of 1+6 and it is made of annealed copper wire.

## Chapter 1 Built-in FNet communication

### 2) Classification by using frequency

Classification	Using frequency (MHz)	Transfer rate (Mbps)	Use
Category 1	Sound frequency	1	▪Telephone network (2Pair)
Category 2	4	4	▪Multi-Pair communication cable
Category 3	16	16	▪Telephone network + computer network
Category 4	20	20	▪Computer network transfer rate Up ▪Low-loss communication cable
Category 5 and expanded category 5	100	100	▪Digital telephone network +computer network ▪Low-loss, broadband cable
Category 6	250 ~ 500	10G	▪10G BASE-T Cable
Category 7	600~	10G	▪appropriate foe STP

#### Notice

Now, Category 3, 5, En-Category 5 and Category 6 are widely used domestically and internationally. Category 4 disappeared due to emergence of Category 5 and Category 7 that is the STP structure is still at a development stage worldwide.

### 3) Example of Category 5 twisted pair cable (UTP) (CTP-LAN5)

Items	Unit		Value
Conductor resistance (Max.)	Ω/km		93.5
Insulation resistance (Min.)	MΩ·km		2,500
Withstand voltage	V/minute		AC 500
Characteristic impedance	Ω (1~100MHz)		100 ± 15
Attenuation	Less than dB/100m	10MHz	6.5
		16MHz	8.2
		20MHz	9.3
Near-end crosstalk attenuation	Less than dB/100m	10MHz	47
		16MHz	44
		20MHz	42

<UTP cable specifications>

## 1.3 Specifications of installation and a trial run

### 1.3.1 Example of FNet installation

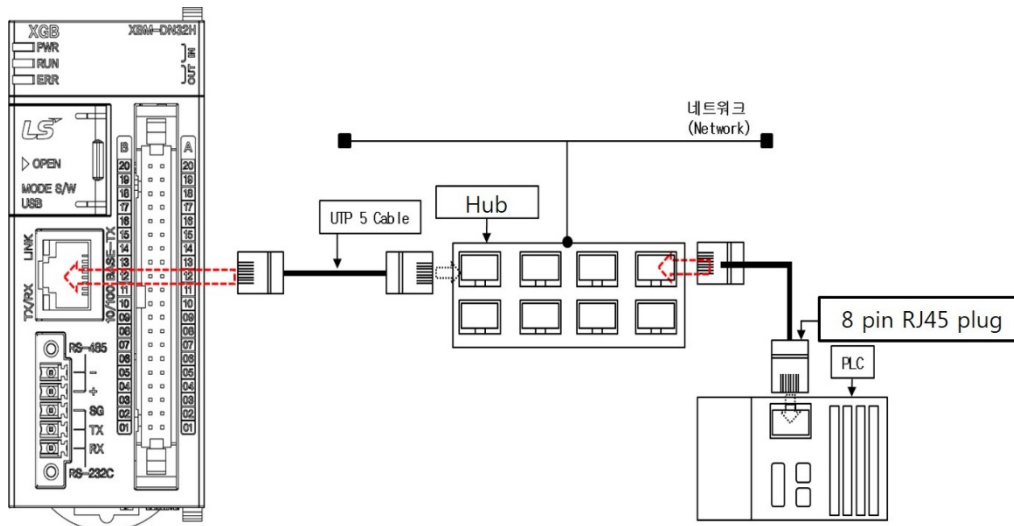

### 1.3.2 Instructions to install cables

In the case of 10/100 BASE-TX, the maximum length between nodes is 100m (distance between this module and the hub). Generally, a hub uses the straight cable made of twisted transmission (TD) and reception (RD) internally. If you connect these 2 basic units, they can be used regardless of cable types since the built-in FNet interface supports Auto-MDIX.

You can connect the signal lines of straight cables and cross cables as below.

#### (1) Straight cable

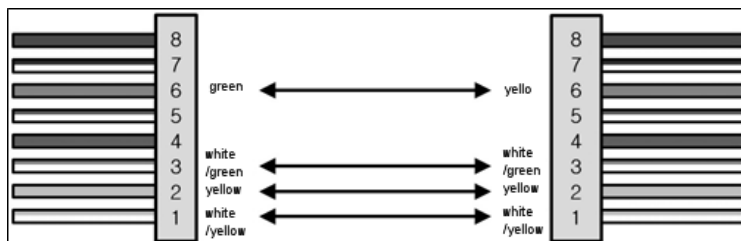

#### (2) Cross cable

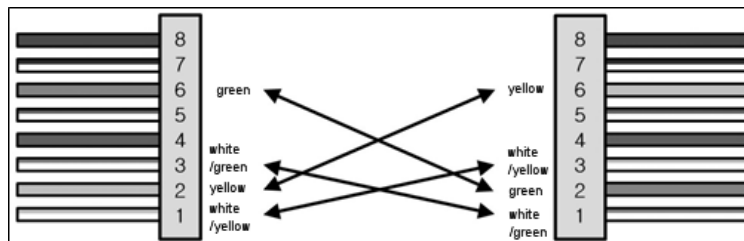

#### Notice

- (1) Separate the hub's power supply from the PLC's power supply.
- (2) For termination and manufacture, installation of cables, contact the professional manufacturers.

### 1.3.3 Instructions to install the UTP

Use the UTP cable that meets the characteristics of Category-5. Be careful not to exceed the cable's tensile force by constraint during wiring. When stripping the cable's sheath, strip it by the length to be connected and be careful not to damage the insulator.

When installing the UTP cable, keep the proper distance between the EMI source and the UTP cable.

Conditions	Minimum separation distance		
	Less than 2.0 kVA	2.5 kVA	More than 5.0 kVA
In case the unshielded power line or electric equipments are open or close to the non-metallic pipes.	127 mm	305 mm	610 mm
In case the unshielded power line or electric equipments are open or close to the buried metallic pipes.	64 mm	152 mm	305 mm
In case the power line of the buried metallic pipes (or equivalent shielded ones) is close to the buried metallic pipes.	-	76 mm	152 mm
Transformer /electric motor fluorescent light	1,016 mm / 305 mm		

< Separation distance by conditions when installing the UTP cable >

Items	Color	Operation details of each status		
		LINK/ACT	Yellow	ON
OFF	Connection error			No connected device
Flickering	During communication			Flickering in case RX, TX occur
SPEED	Green	ON	100BASE-T	In progress at 100Mbps
		OFF	10BASE-T	In progress at 10Mbps

### 1.3.4 How to make a trial run

1) Setting procedures of the product before operation

It describes the installation of the product and procedures before operation. If the installation of the product is completed, install and set up the system based on the below procedures.

Refer to the following items to be checked before operating the system with the built-in FEnet.

2) Communication interface

Items to be checked
Installation and execution, operation of XG5000
Access Status of communication cables (Only when the cable is accessed)

3) Trial run sequence

Startup
<p>Apply the power:</p> <ul style="list-style-type: none"> <li>(1) Check input power.</li> <li>(2) Check the communication cable access.</li> <li>(3) Apply the power.</li> <li>(4) Check whether the power LED is turned on.</li> <li>(5) Check the LED status of the basic unit</li> </ul> <p>→ In case of abnormal status, refer to 'Troubleshooting' of the basic unit manual.</p> <ul style="list-style-type: none"> <li>(6) Check whether the status of the LINK LED is normal.</li> </ul> <p>→ In case the LED is turned off despite connecting the line to the cable, refer to 'Troubleshooting' of the basic unit manual.</p> <ul style="list-style-type: none"> <li>(7) After setting the system parameters correctly, download them.</li> </ul>

4) Instructions for system configuration

When you configure the system with XGB's built-in FEnet, refer to the below for installation.

(1) Check the basic factors required for system configuration and select the proper communication interface.

(2) Choose the dedicated cable for communication modules.

(3) When installing communication cables, check whether the connector pins are damaged or not.

(4) For expansion communication modules besides built-in communication, the maximum of 4 stages can be equipped within the number of stages as below.

(2EA of existing communication expansion modules, 2 EA of high speed communication interfaces for XGB high performance basic unit can be equipped)

The following table shows the number of expansion stages for each basic unit type.

Type	XBC			XEC			XBM
	Super premium	Premium	Standard	Super premium	Premium	Standard	Moduler
Maximum number of expansion stages	10-stage	10-stage	7-stage	10-stage	10-stage	7-stage	7-stage

(5) When installing modules, lock the modules after equipping the relevant slot without accessing the communication cable. In case the device is not locked up, interface error with the basic unit may occur.

## 5) Instructions for network configuration

- (1) The IP addresses of devices should be different. If the IP addresses are overlapped, communication will not work normally.
- (2) Set up the different exchange numbers for each station to use the high speed link service.
- (3) Use the specified communication cables. Otherwise, communication problems may occur.
- (4) Check whether the cables are disconnected or shorted before installing the communication cables.
- (5) Fix them tightly until the communication cable connector clicks
- (6) In case the cable access is unstable, it may cause serious communicable problems.
- (7) For wiring, separate the communication cables from the power line or inductive noise.

## 1.4 Configuration of FNet communication system

XBM's built-in FNet supports open Ethernet so you can configure the network by connecting with LS ELECTRIC and other companies' PLCs, PCs. Some examples of network system configurations are represented as below.

### 1.4.1 Mixed network configuration

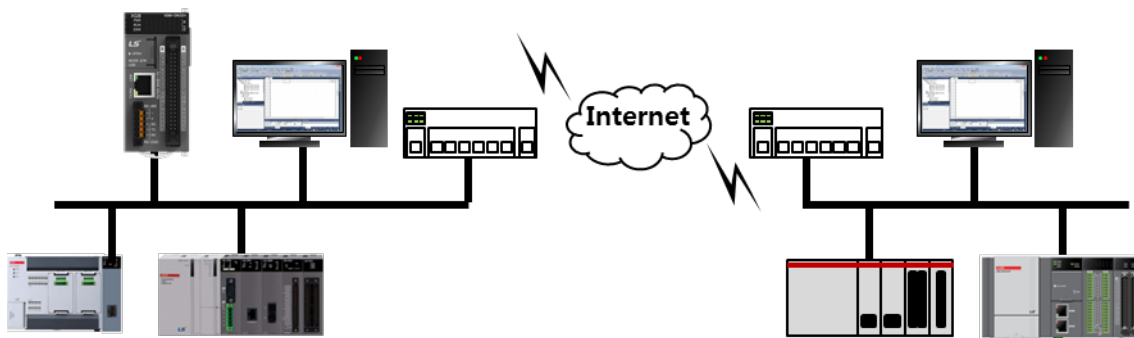

[Fig.1.4.1] System configuration diagram

XGB's built-in FNet accesses LS ELECTRIC PLC, other companies' PLCs, PCs, etc. through the network. You can configure the system by using dedicated communication, Modbus TCP/IP, user-defined frame, high speed link communication.

### 1.4.2 Network configuration through XGB PLC

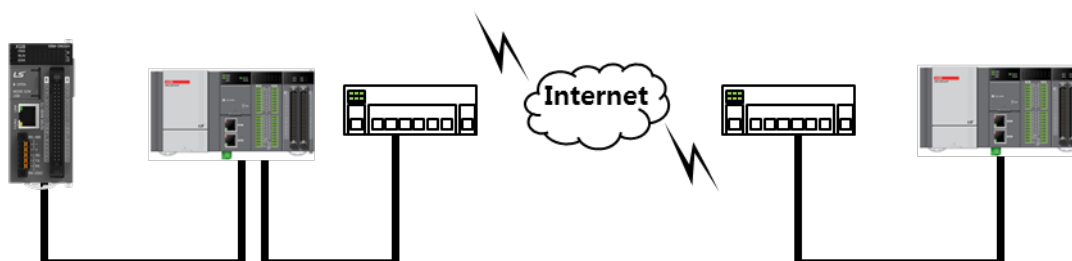

[Fig. 1.4.2] System configuration diagram

XGB's built-in FNet can access to 1:1 communication or network and perform 1:N communication by using cross cables or straight cables. You can transmit and receive the data through the dedicated services, Modbus TCP/IP, user-defined frame and high speed link communication.

### 1.4.3 Network configuration through XGB PLC and MMI

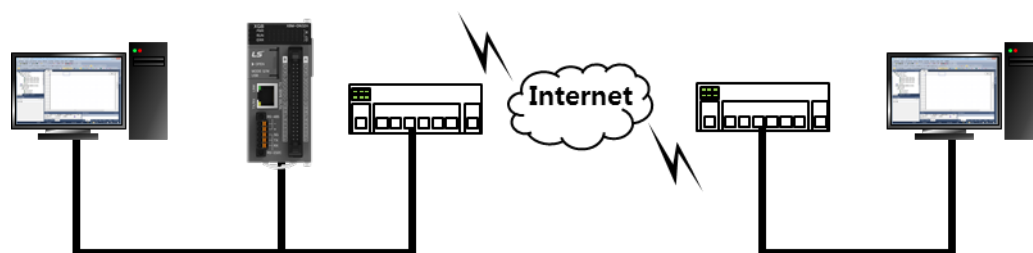

[Fig.1.4.3] System configuration diagram

For communication between XGB's built-in FENet and the PC, 1:N communication is available by accessing to 1:1 communication or the network using cross cables or straight cables. You can transmit and receive data in the PC by using XG5000 or MMI. In addition, through XG5000, you can make, download, upload the program and parameters and transmit/receive data through dedicated services, Modbus TCP/IP, user-defined frame.

### 1.4.4 Network configuration between LS ELECTRIC modules

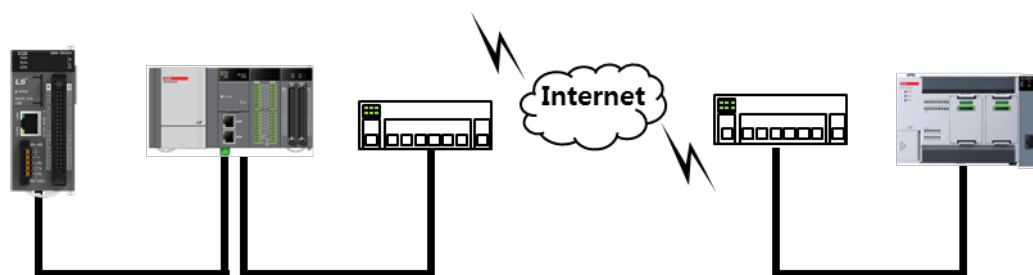

[Fig.1.4.4] System configuration diagram

You can configure the system by using XGB's built-in FENet and XGK PLC's FENet I/F expansion modules. 1:N communication is available through 1:1 communication using cross cables or accessing to network. You can transmit and receive the data through the dedicated services, Modbus TCP/IP, user-defined frame and high speed link communication.

### 1.4.5 Network configuration using XGB PLC and other companies' PLCs

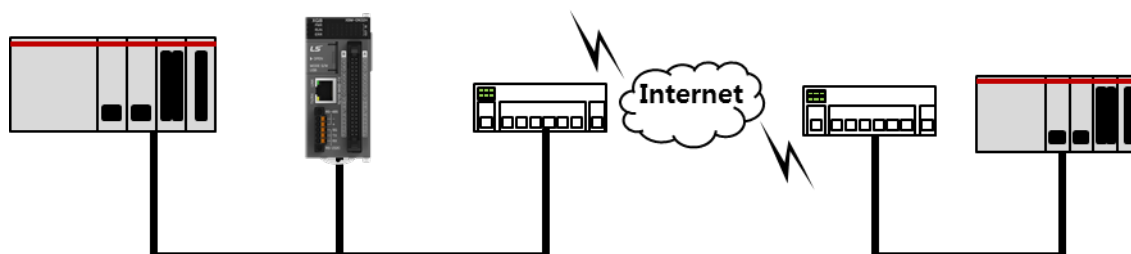

[Fig.1.4.5] System configuration diagram

XGB's built-in FENet can communicate with other companies' PLCs, HMIs, MMIs. 1:N communication is available through 1:1 communication using cross cables or accessing to network. For communication, the PLCs should have the same protocol.



## 1.5 Protocols for each service

XBM high performance basic unit's built-in FEnet interface supports Ethernet(open Ethernet), so you can configure the network by connecting with LS ELECTRIC and other companies' PLCs, PCs.

For communication after network configuration, make sure to set up IP, parameters of each PLC, protocols. The protocols supported by the built-in FEnet are XGT dedicated, Modbus TCP/IP, user-defined frame, File Transfer Protocol (FTP).

Each protocol is operated by the server or client and dedicated server, P2P functions communicate based on designated protocols.

Items		Specifications			
		Driver	Communication method	Port No.	Remarks
Communication function	Dedicated	XGT server	TCP/IP	2004	Up to 4channels Up to 512 bytes
			UDP/IP	2005	
		Modbus TCP server	TCP/IP	502	
	P2P	XGT client	TCP/IP	2004	Up to 3channels Up to 32 blocks
			UDP/IP	2005	
		Modbus TCP client	TCP/IP	502	
		User-defined frame	TCP/IP	Customized	
	UDP/IP		Customized		
	Auto Scan	-	UDP/IP	2007(list) 2008(Information)	Up to 2channels
	SNTP	Client	UDP/IP	Customized	Up to 1channels
SMTP	Client	TCP/IP	25(Relay) Customized	Up to 2channels	

[Table 1.5.1] Protocols by communication functions

### 1.5.1 XGT dedicated protocol

1) Protocol outline

Dedicated protocols for XGT are the communication protocols for LS ELECTRIC PLC only for communication between LS ELECTRIC modules. You can Read/Write data with commands and communication is available in PC, HMI by using dedicated protocols for XGT. Two communication methods of TCP and UDP can be applied to the dedicated protocols for XGT.

Protocol	Communication Method	Port No.
For XGT only	TCP/IP	2004
	UDP/IP	2005

[Table 1.5.2] Classification of dedicated protocols for XGT

2) Frame structure

(1) XGT dedicated packet's structure through Ethernet

When communicating with dedicated protocols for XGT, MAC, IP header (IP Header), TCP Header and LS frames containing data are included for Ethernet communication. [Fig. 1.5.1] shows the frame structure for Ethernet communication.

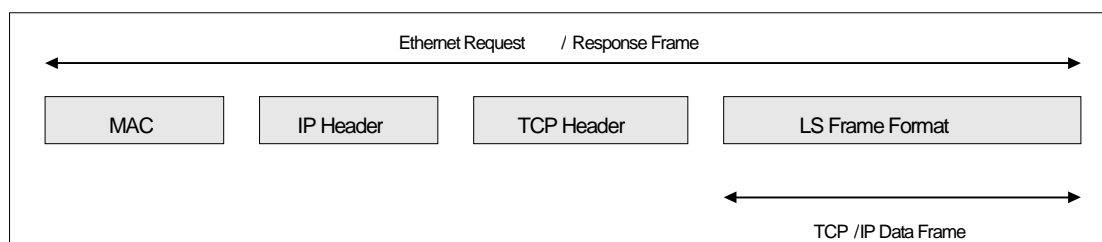

[Fig. 1.5.1] XGT dedicated packet structure through Ethernet

3) Structure of XGT dedicated frame

The LS frames for data communication include LS ELECTRIC's own data (Company ID), command (Command), data type (Data Type), data (Data). [Fig. 1.5.2] shows the frame form.

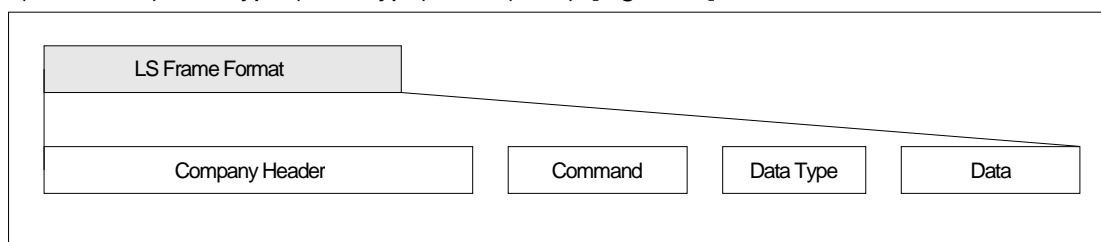

[Fig. 1.5.2] Structure of dedicated frames for XGT

## 4) Data type of XGT dedicated protocols

## (1) Device type

The data types of [Table 1.5.3] are available in the dedicated protocols for XGT. When you designate the devices, '%' (25H) should be attached to the front of string.

('%' is the character indicating the startup of devices)

Data type	Type code value	Flag	Example of application
Bit	h0000	X (58h)	%PX000, %MX000, %LX000, %KX000, %CX000, %TX000, %FX000, %IX0.0.0, %QX0.0.0, %UX00.00.0, etc.
Byte	h0100	B (42h)	PB000, %MB000, %LB000, %KB000, %CB000, %TB000, %FB000, %IB0.0.0, %QB0.0.0, etc.
Word	h0200	W (57h)	%PW000, %MW000, %LW000, %KW000, %CW000, %TW000, %FW000, %DW000, %IW0.0.0, %QW0.0.0, %MW0, %RW0, %WW0, %UW00.00, etc.
D word	h0300	D (44h)	%PD000, %MD000, %LD000, %KD000, %CD000, %TD000, %FD000, %DD000, %ID0.0.0, %QD0.0.0, %MD0, %RD0, %WD0, etc.
L word	h0400	L (4Ch)	%PL000, %ML000, %LL000, %KL000, %CL000, %TL000, %FL000, %DL000, %IL0.0.0, %QL0.0.0, %ML0, %RL0, %WL0, etc.

[Table 1.5.3] Data types of dedicated protocols for XGT

**Notice**

- (1) In the timer/counter, designating bit means the contact values; designating byte, word values means the current values.
- (2) The data register (D) can be designated as Byte, Word only.
- (3) In the case of byte type command, the address value is doubled compared to the value at the time of designating word. Namely, in the case of D1234, %DW1234 should be applied for word designation but %DB2468 should be applied for byte designation.

## Chapter 1 Built-in FENet communication

### 5) Commands of XGT dedicated protocols

4 commands are used for XGT dedicated protocols and each command processes Read/Write, Request/Response.

For available data types for each command, individual one can apply bit, byte, word, double word, long word; continuous one can adopt byte only.

Command	Command code	Data format		Processing details
Read	Request: h0000	Individual	h0000	Request on reading data depending on each data type
			h0100	
			h0200	
			h0300	
			h0400	
	Continuous	h1400	Request on reading byte type of variables by block	
Response: h5500	Individual		h0000	Response to the request on reading data
			h0100	
			h0200	
			h0300	
			h0400	
	Continuous	h1400	Response to the request on reading by block	
Write	Request: h5800	Individual	h0000	Request on writing data depending on each data type
			h0100	
			h0200	
			h0300	
			h0400	
	Continuous	h1400	Request on writing byte type of variables by block	
Response: h5900	Individual		h0000	Response to the request on writing data
			h0100	
			h0200	
			h0300	
			h0400	
	Continuous	h1400	Response to the request on writing by block	

[Table 1.5.4] Command types of XGT dedicated protocols

6) Headers and data structures of XGT dedicated protocols

Items	Client (request frame)			Server (response frame)				
	Classification	Details	Size	Classification	Details	Size		
Company header	LS'S OWN	Company ID 1	10	LS'S OWN	Company ID 1 Company ID 2	10		
	PLC information	h00~hFF	2	PLC information	h00 ~ hFF	2		
	CPU information	hA0	1	CPU information	hA0	1		
	Frame direction	h33	1	Frame direction	h11	1		
	Frame sequence number	h0000~hFFFF	2	Frame sequence number	h0000~hFFFF	2		
	Length	h0000~h0100	2	Length	h0000~h0100	2		
	Position information	h00~hFF	1	Position information	h00~hFF	1		
	Check Sum	h00~hFF	1	Check Sum	h00~hFF	1		
Command	Command	h5400	Read	2	Command	h5500	Read	2
		h5800	Write	2		h5900	Write	2
Data Type	Data type	h0000	bit	2	Data type	h0000	bit	2
		h0100	byte			h0100	byte	
		h0200	word			h0200	word	
		h0300	Double word			h0300	Double word	
		h0400	long word			h0400	Long word	
		h1400	Continuous			h1400	Continuous	
Data	Reserved area	-		2	Reserved area	-		2
	Number of blocks	h0100~h1000		2	Error status	h0000~hFFFF		2
	Variable length (N)	h0400~h1000		2	Data			2
	Data address	-		N				
	Number of data	h0 (M)00		M				

[Table 1.5.5] Headers and data structures of XGT dedicated protocols

(1) Company ID (LS ELECTRIC'S own number)

The LS's own number has two types; XGK and XGB PLC use Company ID 1 when they are operated as the client; the Company ID requested by the client is used when they are operated as server. For client, Company ID 1 or Company ID 2 should be used.

Type	Mode	Frame										Remarks
Company ID 1	ASCII	L	S	I	S	-	X	G	T	/n	/n	XGT
	HEX	h4C	h53	h49	h53	h2D	h58	h47	h54	h00	h00	
Company ID 2	ASCII	L	G	I	S	-	G	L	O	F	A	GM,MK
	HEX	h4C	h47	h49	h53	h2D	h47	h4C	h4F	h46	h41	

[Table 1.5.6] LS's Own Number

## Chapter 1 Built-in FNet communication

### 7) Example of transmission/reception frames

#### (1) Request frame for reading variables individually

Items	Type	Frame										Size
Company ID	ASCII	L	S	I	S	-	X	G	T	/n	/n	10
	HEX	0x4C	0x53	0x49	0x53	0x2D	0x58	0x47	0x54	0x00	0x00	
	ASCII	L	G	I	S	-	G	L	O	F	A	
	HEX	0x4C	0x47	0x49	0x53	0x2D	0x47	0x4C	0x4F	0x46	0x41	
PLC Info	HEX	0x00	0x00									2
CPU Info		0xA0										1
Source of Frame		0x33										1
Invoked ID		0x00	0x01									2
Length		0x10	0x00									2
Position		0x00										1
Check Sum		0x09										1
Command		0x54	0x00									2
Data Type		0x14	0x00									2
Reserved		0x00	0x00									2
Block No.		0x01	0x00									2
Variable Length		0x04	0x00									2
Data Address	ASCII	%	M	B	0							4
	HEX	0x25	0x4D	0x42	0x30							
Data Count	HEX	0x02	0x00									2

[Table 1.5.7] Request frame for reading variables individually

#### (2) Response frame for reading variables individually

Items	Type	Frame										Size
Company ID	ASCII	L	S	I	S	-	X	G	T	/n	/n	10
	HEX	0x4C	0x53	0x49	0x53	0x2D	0x58	0x47	0x54	0x00	0x00	
	ASCII	L	G	I	S	-	G	L	O	F	A	
	HEX	0x4C	0x47	0x49	0x53	0x2D	0x47	0x4C	0x4F	0x46	0x41	
PLC Info	HEX	0x02	0x08									2
CPU Info		0xA0										1
Source of Frame		0x11										1
Invoked ID		0x00	0x01									2
Length		0x0E	0x00									2
Position		0x01										1
Check Sum		0x25										1
Command		0x55	0x00									2
Data Type		0x14	0x00									2
Reserved		0x00	0x00									2
Error State		0x00	0x00									2
Block No.		0x10	0x00									2
Data Count		0x02	0x00									2
Data		0x00	0x00									2

[Table 1.5.8] Response frame for reading variables individually

(3) Request frame for reading variables sequentially

Items	Type	Frame										Size
Company ID	ASCII	L	S	I	S	-	X	G	T	/n	/n	10
	HEX	0x4C	0x53	0x49	0x53	0x2D	0x58	0x47	0x54	0x00	0x00	
	ASCII	L	G	I	S	-	G	L	O	F	A	
	HEX	0x4C	0x47	0x49	0x53	0x2D	0x47	0x4C	0x4F	0x46	0x41	
PLC Info	HEX	0x00	0x00									2
CPU Info		0xA0										1
Source of Frame		0x33										1
Invoked ID		0x00	0x01									2
Length		0x10	0x00									2
Position		0x00										1
Check Sum		0x09										1
Command		0x54	0x00									2
Data Type		0x14	0x00									2
Reserved		0x00	0x00									2
Block No.		0x01	0x00									2
Variable Length		0x04	0x00									2
Data Address	ASCII	%	M	B	0							4
	HEX	0x25	0x4D	0x42	0x30							
Data Count	HEX	0x02	0x00									2

[Table 1.5.9] Frame for reading variables sequentially

(4) Response frame for reading variables sequentially

Items	Type	Frame										Size
Company ID	ASCII	L	S	I	S	-	X	G	T	/n	/n	10
	HEX	0x4C	0x53	0x49	0x53	0x2D	0x58	0x47	0x54	0x00	0x00	
	ASCII	L	G	I	S	-	G	L	O	F	A	
	HEX	0x4C	0x47	0x49	0x53	0x2D	0x47	0x4C	0x4F	0x46	0x41	
PLC Info	HEX	0x02	0x08									2
CPU Info		0xA0										1
Source of Frame		0x11										1
Invoked ID		0x00	0x01									2
Length		0x0E	0x00									2
Position		0x01										1
Check Sum		0x25										1
Command		0x55	0x00									2
Data Type		0x14	0x00									2
Reserved		0x00	0x00									2
Error State		0x00	0x00									2
Block No.		0x10	0x00									2
Data Count		0x02	0x00									2
Data		0x00	0x00									2

[Table 1.5.10] Response frame for reading variables sequentially

## 1.5.2 Modbus TCP/IP protocol

The Modbus TCP/IP protocol is the function to Read/Write data by using the function codes. The Modbus TCP/IP frame is composed of MAC for Ethernet communication, IP header, TCP header, Modbus ADU.

- 1) ADU: Application Data Unit
- 2) MBAP: Modbus Application Protocol
- 3) PDU: Protocol Data Unit

### 1) Frame structure of Modbus TCP/IP

#### (1) Modbus TCP/IP's frame structure through Ethernet

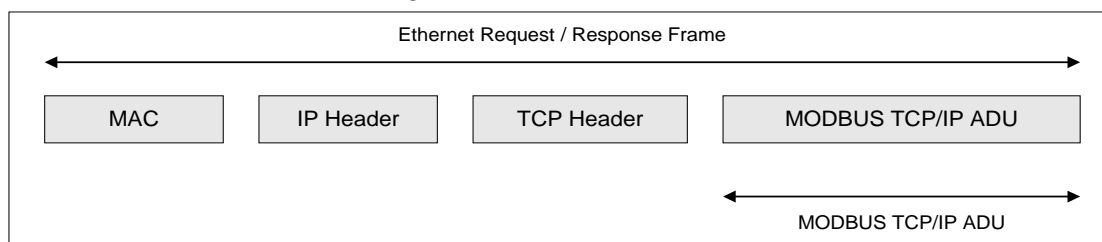

[Table 1.5.1] Modbus TCP/IP's frame structure through Ethernet

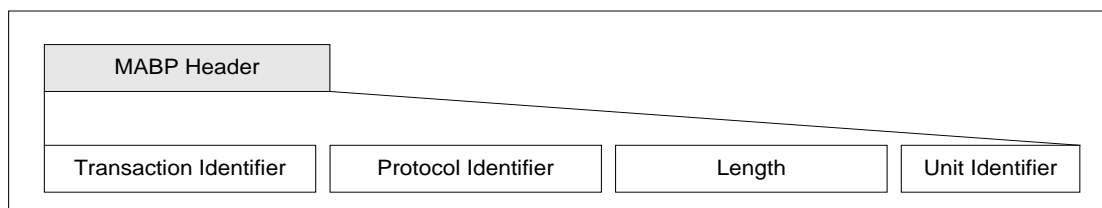

[Table 1.5.2] Modbus MABP structure

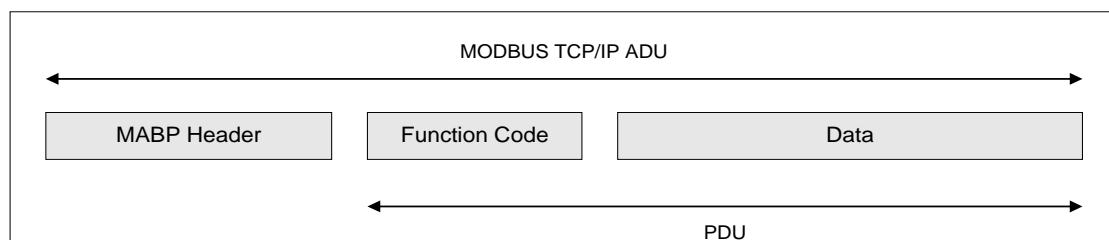

[Table 1.5.3] Modbus ADU structure



(2) MBAP Header structure

Type	Size	Description	Client	Server
Transaction Identifier	2byte	Separation of MODBUS request/response processing	Initialized by the client	When the server responds, it is copied and responded.
Protocol Identifier	2byte	0 = MODBUS protocol	Initialized by the client	When the server responds, it is copied from the request frame.
	2byte	Frame size except MBAP	Created by the client (On request)	Created by the server (In case of response)
Unit Identifier	1byte	Separation of units connected to the serial line	Initialized by the client	When the server responds, it is copied from the request frame

(3) Available function codes

Function codes	Function	Modbus transcription
Function Code 01 (h01)	Reading output bit	Read Coils
Function Code 02 (h02)	Reading input bit	Read Discrete Inputs
Function Code 03 (h03)	Reading output word	Read Holding Registers
Function Code 04 (h04)	Reading input word	Write Input Register
Function Code 05 (h05)	Writing output bit	Write single Coil
Function Code 06 (h06)	Writing output word	Write single Register
Function Code 15 (h0F)	Writing output bit sequentially	Write Multiple Coils
Function Code 16 (h10)	Writing output word sequentially	Write Multiple Registers

2) Frame structures by function codes

(1) Function code h01 : Reading output bit (Read Coils)

• Request

Items	Size	Range
Function code	1 byte	h01
Initial address	2 bytes	h0000 ~ hFFFF
Number of coils	2 bytes	h0001 ~ h07D0 (2000 bit)

• Response

Items	Size	Range
Function code	1 byte	h01
Number of bytes	2 bytes	N
Coil status	n byte	n = N or N + 1

• Error

Items	Size	Range
Function code	1 byte	h81 (function code+ h80)
Exceptional code	1 byte	h01,h02,h03,h04

•Example of Application

Request frame		Response frame	
Items	HEX	Items	HEX
Function code	h01	Function code	h01
Initial address (upper byte)	h00	Number of bytes	h03
Initial address (lower byte)	h13	Coil status (27-20)	hCD
Number of coils (upper byte)	h00	Coil status (36-28)	h6B
Number of coils (lower byte)	h13	Coil status (38-36)	h05

(2) Function code h02 : Reading input bit (Read Discrete Inputs)

• Request

Items	Size	Range
Function code	1 byte	h02
Initial address	2 bytes	h0000 ~ hFFFF
Number of inputs	2 bytes	h0001 ~ h07D0 (2000 bit)

• Response

Items	Size	Range
Function code	1 byte	h01
Number of bytes	2 bytes	N
Input status	N x 1 byte	-

• Error

Items	Size	Range
Function code	1 byte	h82 (Function code + h80)
Exceptional code	1 byte	h01,h02,h03,h04

• Example of application

Request frame		Response frame	
Items	HEX	Items	HEX
Function code	h02	Function code	h02
Initial address (upper byte)	h00	Initial address (upper byte)	h00
Initial address (lower byte)	hC4	Initial address (lower byte)	hC4
Input status (upper byte)	h00	Input status (upper byte)	h00
Number of coils (lower byte)	h16	Number of coils (lower byte)	h16

(3) Function code h03 : Reading output word (Read Holding Registers)

• Request

Items	Size	Range
Function code	1 byte	h03
Initial address	2 bytes	h0000 ~ hFFFF
Number of inputs	2 bytes	h0001 ~ h007D (125word)

• Response

Items	Size	Range
Function code	1 byte	h01
Number of bytes	2 bytes	2 x N
Input status	N x 2 bytes	-

• Error

Items	Size	Range
Function code	1 byte	h83 (Function code + h80)
Exceptional code	1 byte	h01,h02,h03,h04

• Example of application

Request frame		Response frame	
Items	HEX	Items	HEX
Function code	h03	Function code	h03
Initial address (upper byte)	h00	Number of bytes	h06
Initial address (lower byte)	h6B	Word status (108)	h02
Number of words (upper byte)	h00	Word status (108)	h2B
Number of words (lower byte)	h03	Word status (109)	h00
		Word status (109)	h00
		Word status (110)	h00
		Word status (110)	h64

(4) Function code h04 : Writing input word (Read Input Registers)

• Request

Items	Size	Range
Function code	1 byte	h04
Initial address	2 bytes	h0000 ~ hFFFF
Number of inputs	2 bytes	h0001 ~ h007D (125word)

• Response

Items	Size	Range
Function code	1 byte	h04
Number of bytes	2 bytes	2 x N
Input status	N x 2 bytes	-

• Error

Items	Size	Range
Function code	1 byte	h84 (Function code + h80)
Exceptional code	1 byte	h01,h02,h03,h04

• Example of application

Request frame		Response frame	
Items	HEX	Items	HEX
Function code	h04	Function code	h04
Initial address (upper byte)	h00	Number of bytes	h02
Initial address (lower byte)	h08	Word status (108)	h00
Number of words (upper byte)	h00	Word status (108)	h0A
Number of words (lower byte)	h01		

(5) Function code h05 : Writing output bit (Write Single Coil)

• Request

Items	Size	Range
Function code	1 byte	h05
Initial address	2 bytes	h0000 ~ hFFFF
Input value	2 bytes	h0000 or hFF0D

• Response

Items	Size	Range
Function code	1 byte	h05
Number of bytes	2 bytes	h0000 ~ hFFFF
Input status	2 bytes	h0000 or hFF00

• Error

Items	Size	Range
Function code	1 byte	h85 (function code+h80)
Exceptional code	1 byte	h01,h02,h03,h04

• Example of application

Request frame		Response frame	
Items	HEX	Items	HEX
Function code	h02	Function code	h01
Initial address (upper byte)	h00	Number of bytes	h03
Initial address (lower byte)	hC4	Coil status (27-20)	hCD
Input status (upper byte)	h00	Coil status (36-28)	h6B
Number of coils (lower byte)	h16	Coil status (38-36)	h05

(6) Function code h 0F : Writing output word sequentially (Write Multiple Registers)

• Request

Items	Size	Range
Function code	1 byte	h0F
Initial address	2 bytes	h0000 ~ hFFFF
Number of outputs	2 bytes	h0001 ~ h07BD
Number of bytes	1 byte	N
Output value	N x 1 byte	

• Response

Items	Size	Range
Function code	1 byte	h0F
Number of bytes	2 bytes	h0000 ~ hFFFF
Input status	2 bytes	h0001 ~ h07B0

• Error

Items	Size	Range
Function code	1 byte	h8F (function code+ h80)
Exceptional code	1 byte	h01,h02,h03,h04

• Example of application

Request frame		Response frame	
Items	HEX	Items	HEX
Function code	h0F	Function code	h0F
Initial address(upper byte)	h00	Initial address (upper byte)	h00
Initial address(lower byte)	h13	Initial address (lower byte)	h13
Number of outputs (upper byte)	h00	Number of outputs (upper byte)	h00
Number of outputs (lower byte)	h0A	Number of outputs (lower byte)	h0A
Number of bytes	h02		
Output value (upper byte)	hCD		
Output value (lower byte)	h01		

(7) function codeh06 : output word (Write Single Register)

• Request

Items	Size	Range
Function code	1 byte	h06
Initial address	2 bytes	h0000 ~ hFFFF
Output value	2 bytes	h0000 or hFFFF

• Response

Items	Size	Range
Function code	1 byte	h06
Initial address	2 bytes	h0000 ~ hFFFF
Output value	2 bytes	h0000 or hFFFF

• Error

Items	Size	Range
Function code	1 byte	h86 (function code+ h80)
Exceptional code	1 byte	h01,h02,h03,h04

• Example of application

Request frame		Response frame	
Items	HEX	Items	HEX
Function code	h06	Function code	h06
Initial address (upper byte)	h00	Number of bytes	h00
Initial address (lower byte)	h01	Coil status (27-20)	h01
Input status (upper byte)	h00	Coil status (36-28)	h00
Number of coils (lower byte)	h03	Coil status (38-36)	h03

(8) Function code h10 : Writing output sequentially (Write Multiple Registers)

• Request

Items	Size	Range
Function code	1 byte	h10
Initial address	2 bytes	h0000 ~ hFFFF
Number of outputs	2 bytes	h0001 or h07D8
Number of bytes	1 byte	2 x N
Output value	N x 2 bytes	value

• Response

Items	Size	Range
Function code	1 byte	h10
Number of bytes	2 bytes	h0000 ~ hFFFF
Number of outputs	2 bytes	h0001 ~ h007B

• Error

Items	Size	Range
Function code	1 byte	h90 (function code+ h80)
Exceptional code	1 byte	h01,h02,h03,h04

• Example of application

Request frame		Response frame	
Items	HEX	Items	HEX
Function code	h10	Function code	h01
Initial address (upper byte)	h00	Initial address (upper byte)	h00
Initial address (lower byte)	h01	Initial address (lower byte)	h01
Number of outputs (upper byte)	h00	Number of outputs (upper byte)	h00
Number of outputs (lower byte)	h02	Number of outputs (lower byte)	h02
Number of bytes	h04		
Output value(upper byte)	h00		
Output value(lower byte)	h0A		
Output value(upper byte)	h01		
Output value(lower byte)	h02		

## 1.6 Dedicated services

### 1.6.1 Outline

#### 1) Server model

The dedicated services mean the server functions in the below client/server model of [Fig. 1.6.1]. It Reads/Writes data based on the protocols assessed and set by the client.

#### (1) Client/server model

The server performs the functions; ② detection of reception ③ transmission of response.

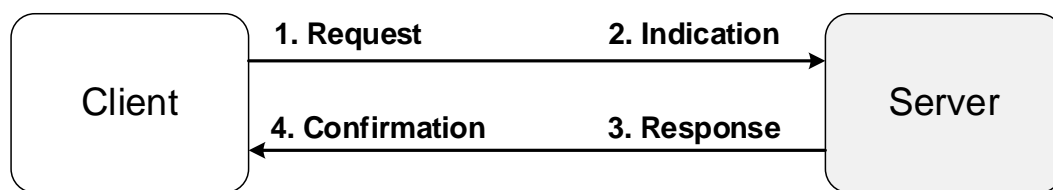

[Fig.1.6.1] Server/client model

#### (2) System configuration

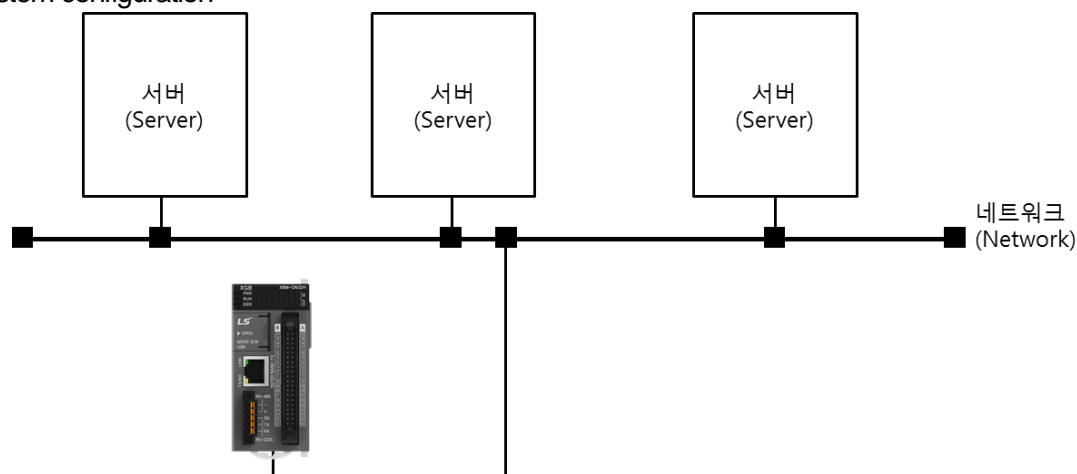

#### (3) Classification of dedicated services

Dedicated services		Port No.	Protocol	Max./Min. number of accesses
XGT server	TCP XGT server	2004	TCP	1/16
	UDP XGT server	2005	UDP	1/16
Modbus TCP/IP server		502	TCP	1/16



## 1.6.2 Setting the basic parameters

- 1) Confirming registration of built-in communication
- (1) Setting the basic parameters for XG5000 communication

If you create a project after executing XG5000, only the basic network will be displayed in the network configuration. After accessing to the PLC, if you execute I/O synchronization in [Online] → [Diagnosis] → [I/O information], the built-in communication modules will be updated. Then, if you choose the built-in FEnet, the window for setting communication modules will be executed. The built-in FEnet is automatically set so you cannot change the type, base, slot.

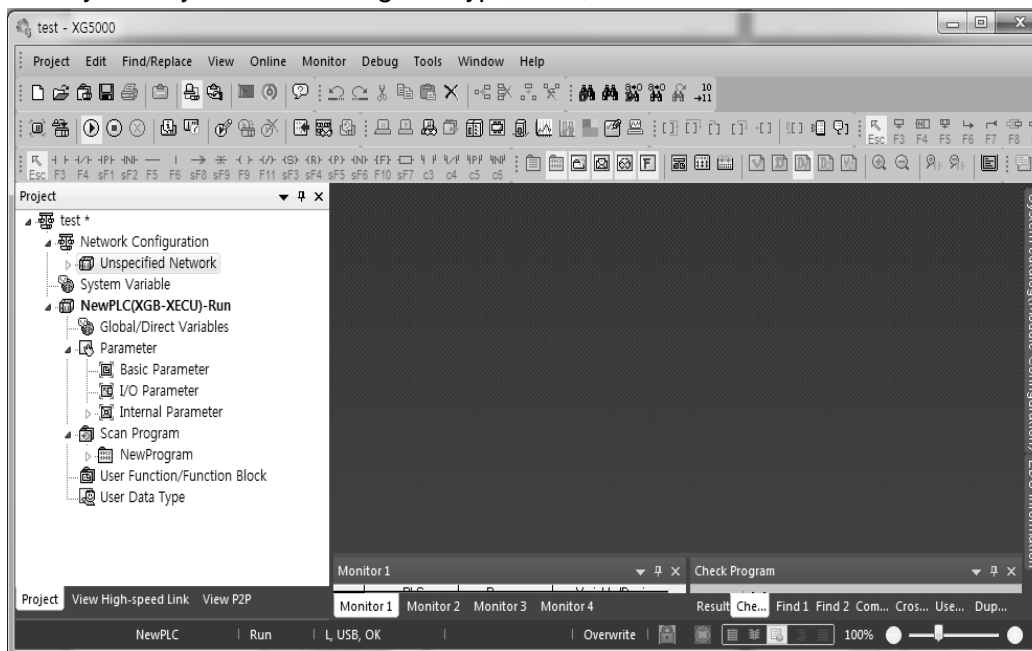

[Fig. 1.6.2] Creation of new project in XG5000

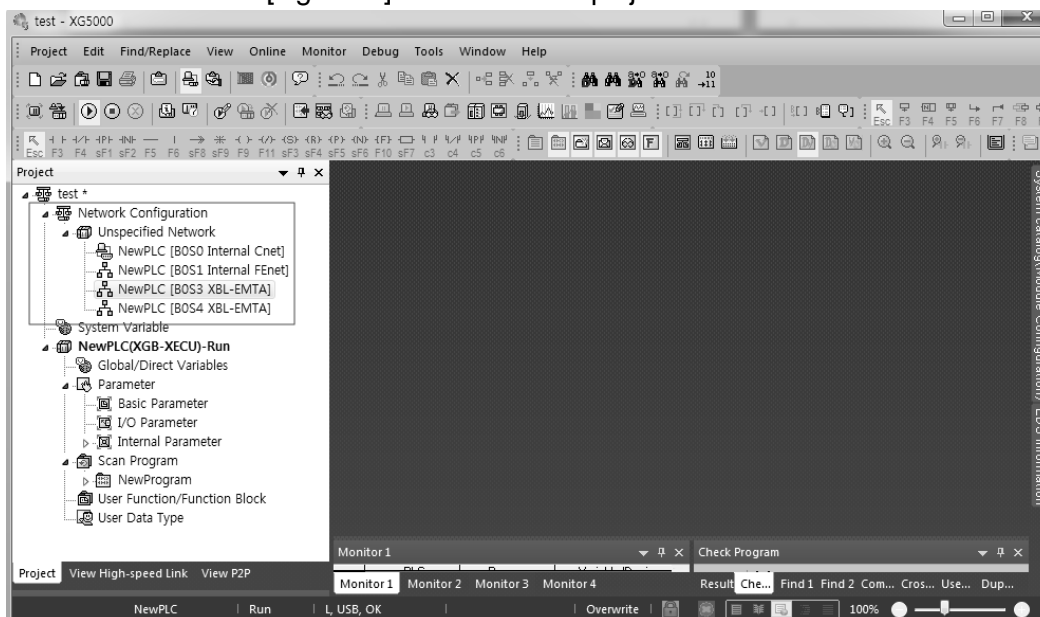

[Fig. 1.6.3] Changes of the network configuration after I/O synchronization

(2) Basic setting

If you double-click the FEnet, the window for the basic setting will be created as below [Fig. 1.6.4].

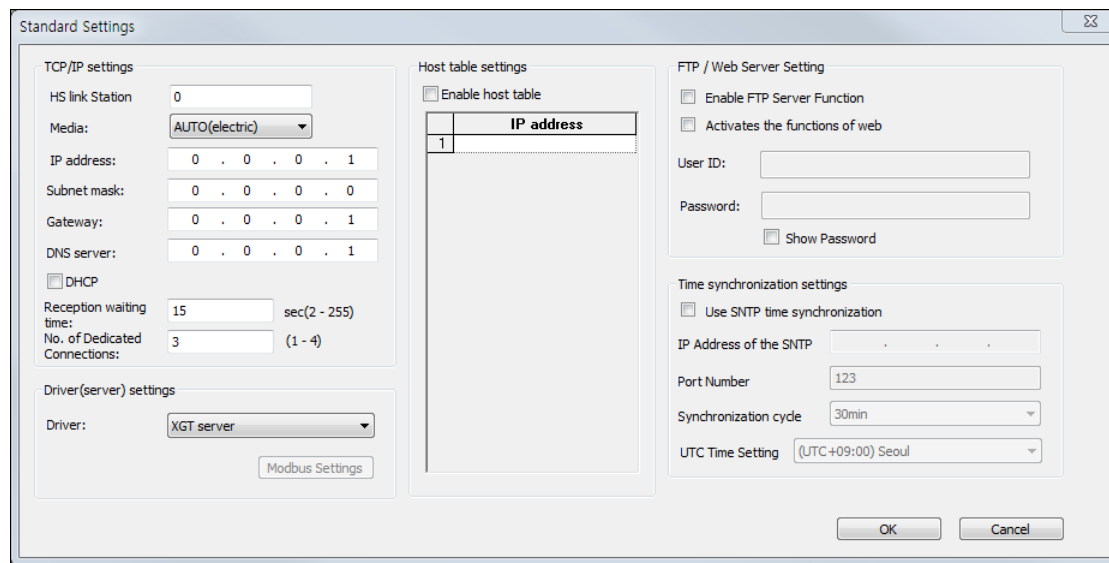

[Fig.1.6.4] Window for the basic settings of communication

The descriptions on each item are as below.

a) TCP/IP setting

Item	Description
High speed link exchange number	For high speed link communication between XGT PLC's FEnet I/F modules, the FEnet I/F module to set exchange number should not overlapped with the exchange numbers of other FEnet I/F modules that are accessible in the network.
Media	Select the media to be used. ▷ AUTO (electricity): It sets the media of the currently equipped module automatically. ▷ 10M/HALF: Half Duplex electricity of 10Mbps ▷ 10M/FULL: Full Duplex electricity of 10Mbps ▷ 100M/HALF: Half Duplex electricity of 100Mbps ▷ 100M/FULL: Full Duplex electricity of 10Mbps
IP address	You can set the IP address of the FEnet I/F module.
Subnet Mask	Value to determine whether the opposing station exists in the same network as its own.
Gateway	Gateway module address (router address) to transmit and receive data through the station using different network from its own or public network.
DNS server	You can designate domain name server.
DHCP	For using the flexible IP instead of the static IP.
Reception standby time (second)	During dedicated communication, if there is not any RUN request for the set time from the upper system on condition that it is assessed to the upper PC or MMI, the connection with the dedicated service will end regardless of normal termination on the assumption that there are some problems with the upper system. The standby time is used for dedicated services to reset the channels when there are some errors in the opposing station or cables are disconnected.
Number of dedicated accesses	It means the maximum number of TCP dedicated services that are assessable at the same time. Setting of 1~4 is available.

	(In the case of P2P channel, the number of 4-dedicated accesses)
--	--

## b) Driver (server) setting

Item	Description
XGT server	For operation with the dedicated communication server
Modbus TCP/IP server	For operation with the Modbus server driver

## c) Host table setting

Item	Description
Enable host table	In case of Enable host table, it allows access for the client who has the IP address registered to the host table.

## d) Setting the time synchronization function

Item	Description
SNTP time synchronization function	Setting SNTP time synchronization operations
IP Address of the SNTP	SNTP server's IP address
Port Number	SNTP server's port No.
Synchronization cycle	Time synchronization cycle between the SNTP server and the PLC
UTC Time setting	Setting SNTP time according to UTC(Universal Time Coordinated)

### 1.6.3 XGT server

The TCP XGT server works in sequence as shown in the operating sequence of the below [Fig. 1.6.5].

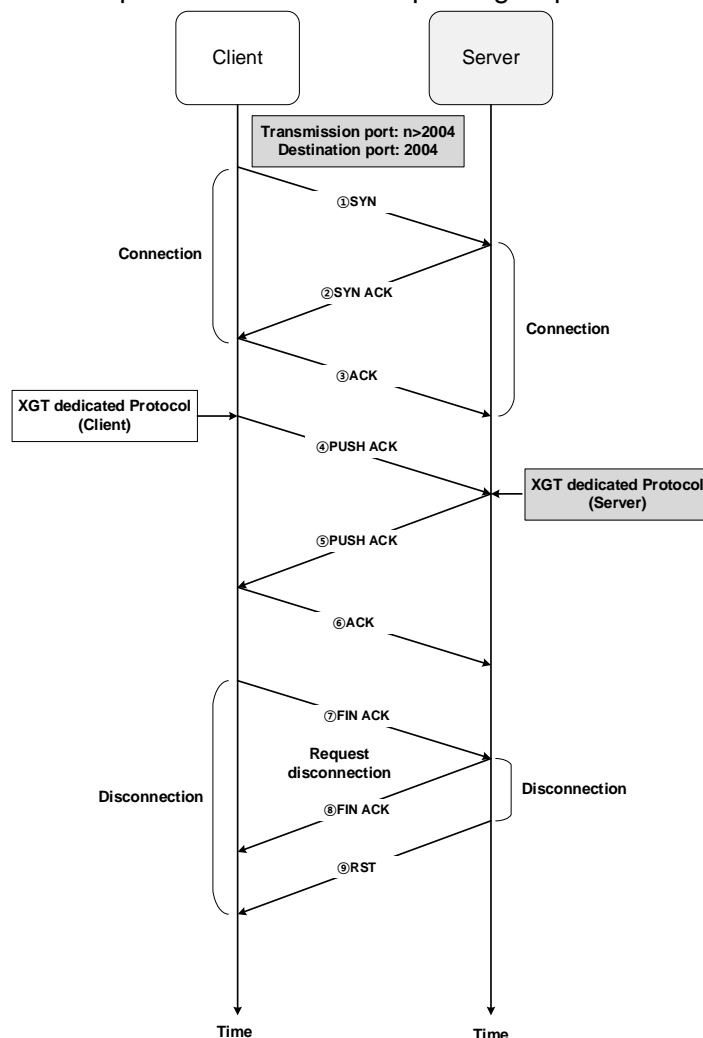

[Fig.1.6.5] Operating sequence of the TCP XGT server

#### 1) Connection

The client sends the ① connection request to the server and then, the server transmits the ② response to connection request. The connection port number is Port No. 2004 of the XGT dedicated protocols. Then, the client sends the ③ response to confirmation of connection. After the stages of ①~ ③ are completed, connection between client/server is made.

#### 2) TCP XGT server

After connection, the client transmits the ④ request frame based on the XGT dedicated protocols. Then, the server transmits the ⑤ response to the request frame and the client transmits the ⑥ confirmation of response.

#### 3) Disconnection

The client transmits ⑦ disconnection request and the server transmits ⑧ confirmation of disconnection and ⑨ terminates the connection.

### 1.6.4 Modbus TCP/IP server

The Modbus TCP/IP server works in sequence as shown in the operating sequence of the below [Fig. 1.6.6].

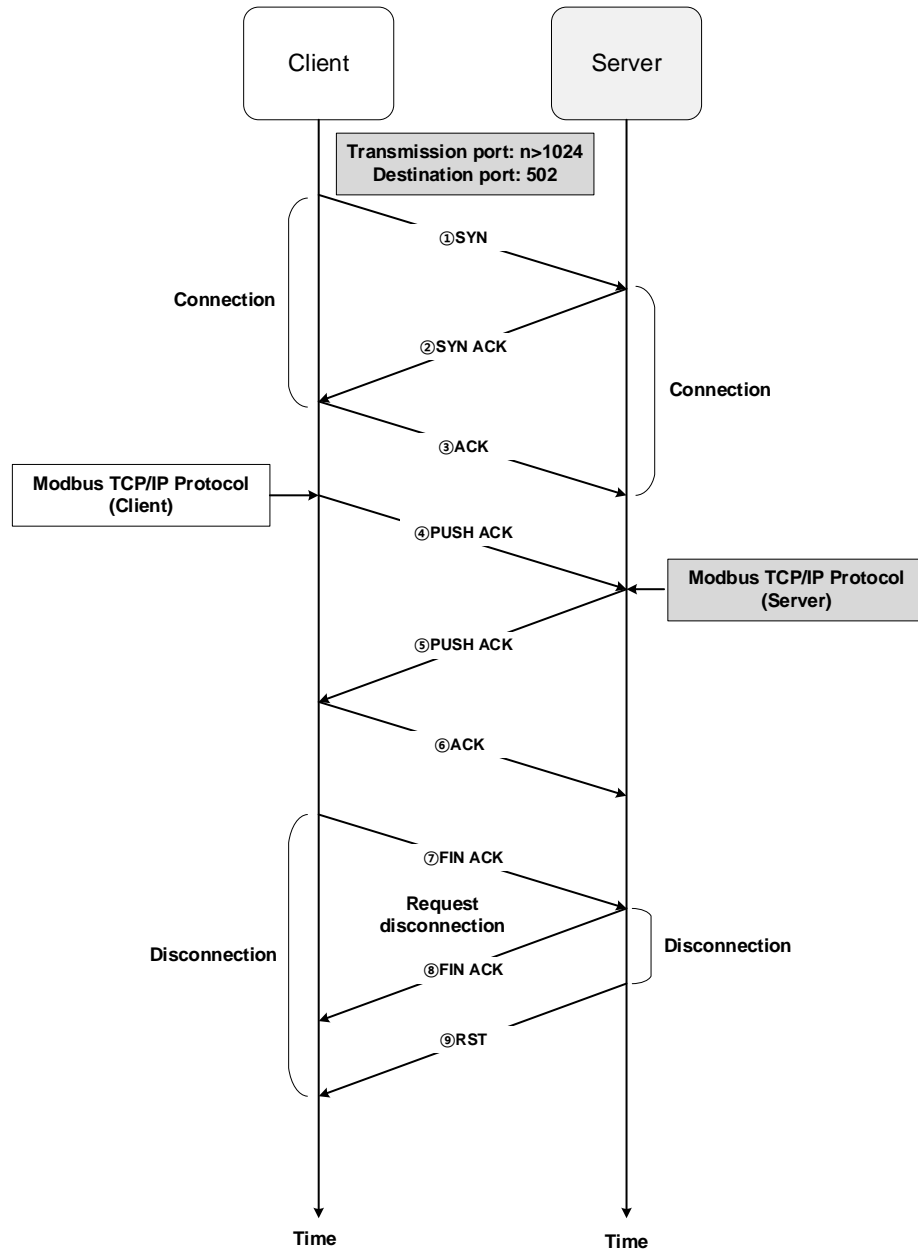

[Fig.1.6.6] Operating sequence of the Modbus TCP/IP server

## 1.7 P2P service

### 1.7.1 Outline

The P2P service means the client function in the below client/server model of [Fig. 1.7.1].

It is the function to request Read/Write Data to the server. If the startup conditions of each block are On, it creates the request frames and receives responses for processing with the protocols that are designated as the relevant channel.

XGB's built-in FEnet can realize the function through up to 7 channels and you can use other protocols for each channel.

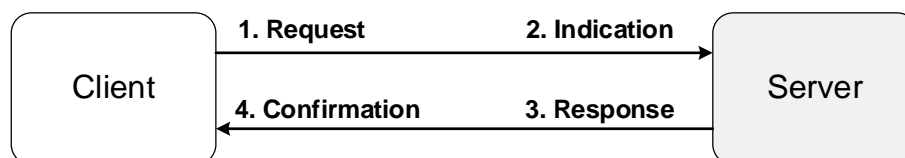

[Fig. 1.7.1] Server/client model

The Client performs the functions of ① transmission of request ④ confirmation.

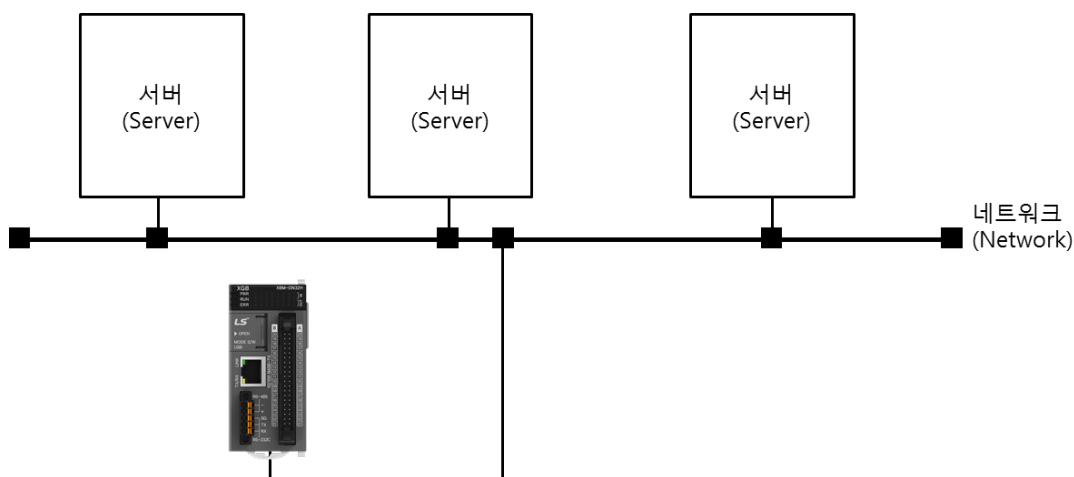

[Fig. 1.7.2] Server/client configuration

## 1.7.2 Setting P2P parameters

[Fig. 1.7.3] shows the example of setting P2P parameters of XG5000.

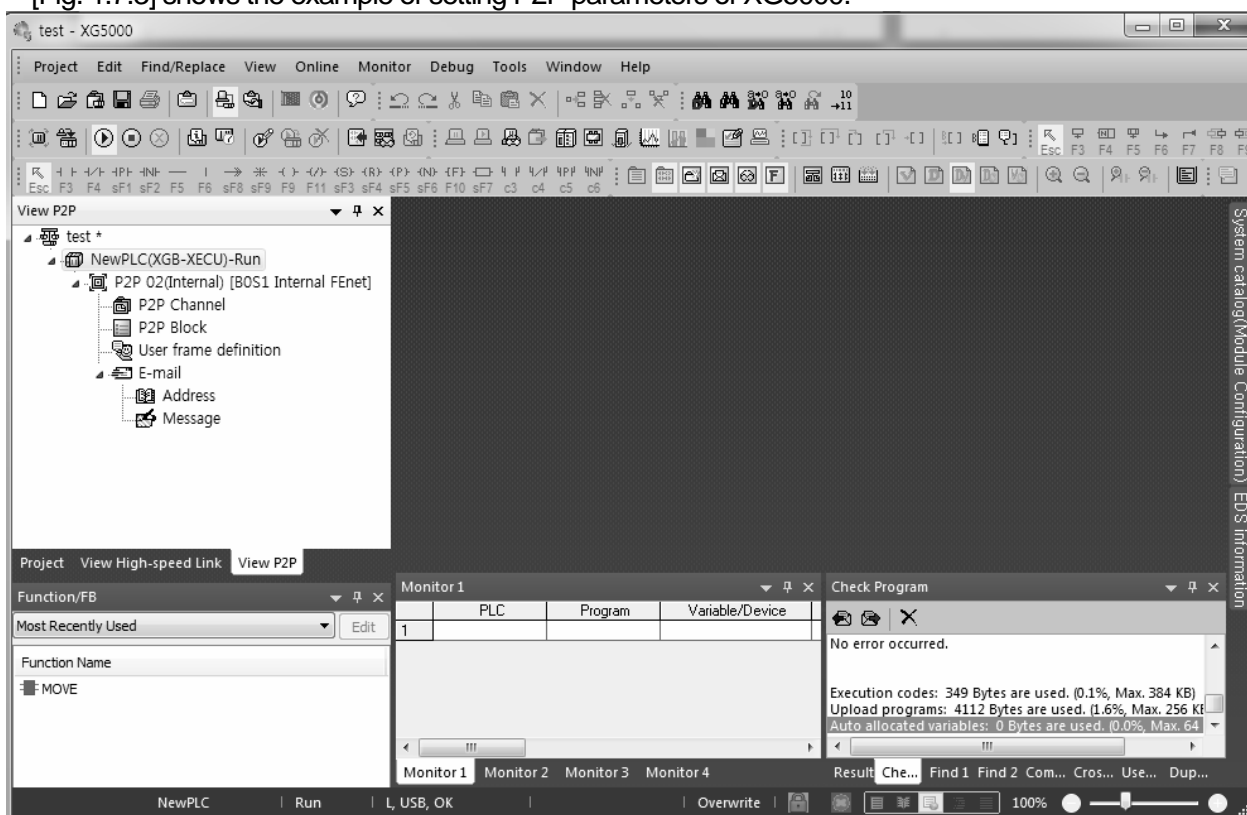

[Fig. 1.7.3] Window for P2P setting of XG5000

- Window for registering P2P parameters
  - You can set the P2P parameters up to 6.
  - Each P2P is composed of P2P channel, P2P block, user-defined frame, E-mail.
- Window for editing P2P
  - You can register and edit P2P block up to 32.
  - You can separately register frames by driver.

## Chapter 1 Built-in FEnet communication

### 1) Setting FEnet communication

You need to set P2P parameters to use P2P services.

- (1) Click the PLC module with the right mouse button on the P2P tab and choose P2P communication.

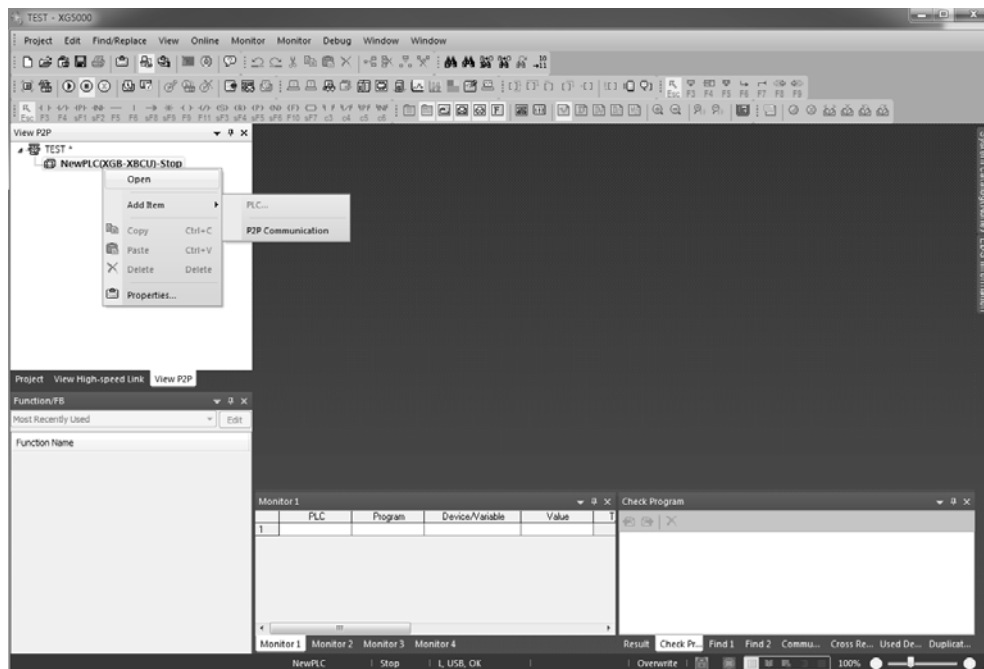

- (2) Choose the P2P number to create the P2P module to be used.

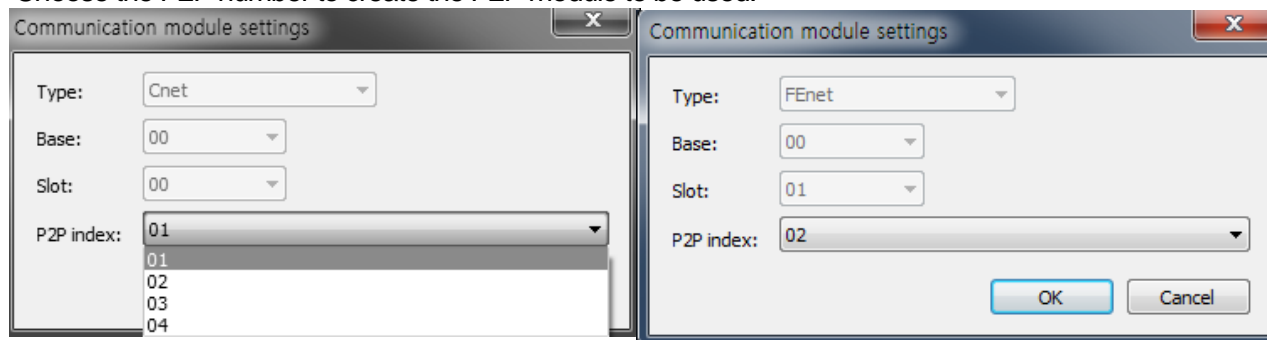

- (3) P2P 01 that XGB basic unit's built-in communication setting is fixed as Cnet.
- (4) P2P 02 that XGB basic unit's built-in communication setting is fixed as FEnet.
- (5) Double-click to confirm the communication settings.
- (6) The base is fixed as 0.
- (7) The slot is automatically designated as slot 2 that has the built-in FEnet.
- (8) If communication settings are completed, click the 'OK' button.
- (9) If you click the 'OK' button, the detailed items of P2P will be created in the project window as the figure of the



2) Configuration of P2P parameters

If you set the communication modules in the P2p screen, the window for setting P2P parameters will be displayed as the below figure. P2P is composed of 4 data.

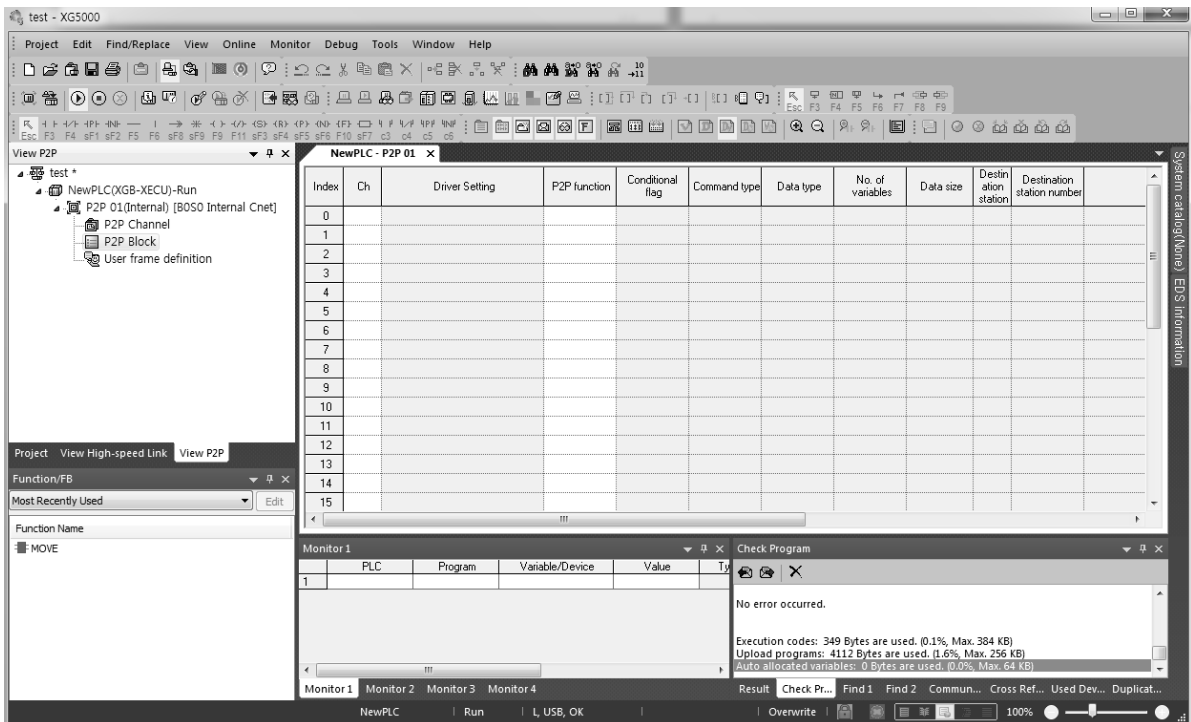
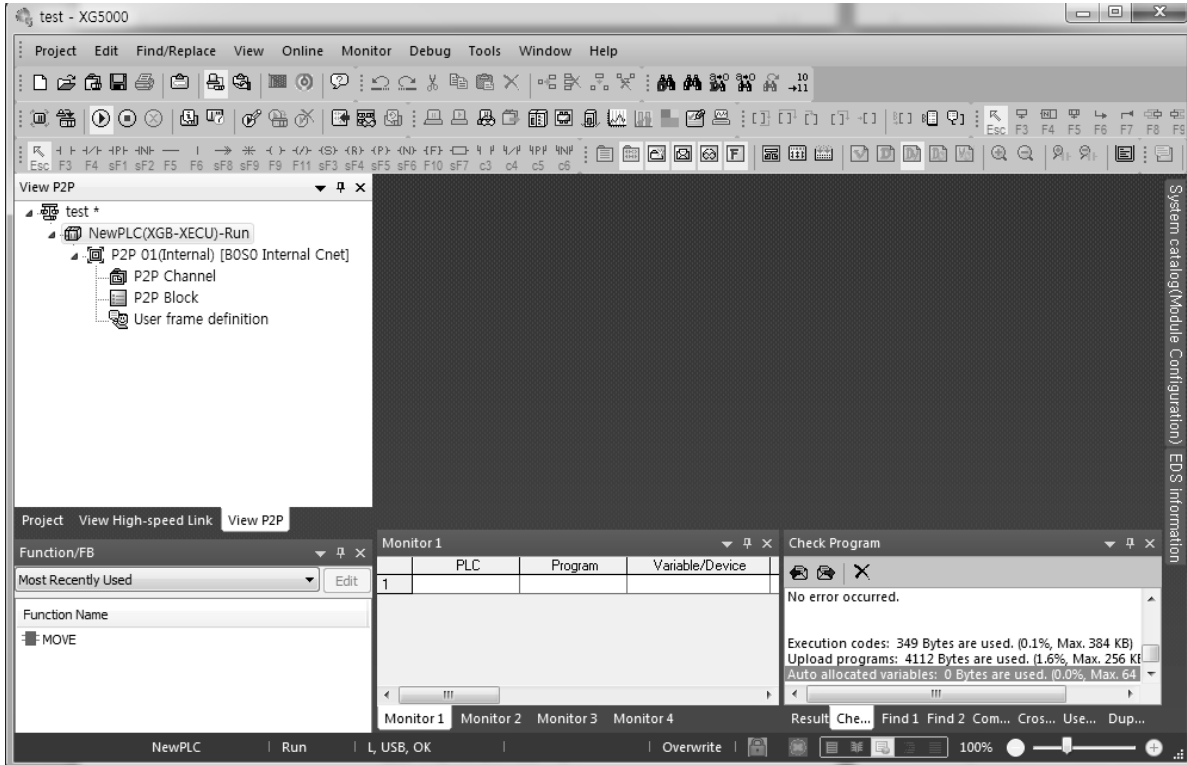

- (1) P2P channel
  - Setting logical channels (IP, PORT, dedicated driver) of P2P services.
  - Setting user-defined frame, XGT client, MODBUS TCP client
  - Setting communication equipments using the protocols other than XGT/MODBUS TCP.
- (2) P2P block
  - Setting 32 P2P blocks that are operated independently.
- (3) User-defined frames
  - Registration of user-defined frames
- (4) E-mail
  - Registration of frames to transmit and receive E-mail frames

### 1.7.3 Kinds of P2P services

#### 1) Kinds of P2P commands

The P2P that a user applies for programming can be divided into 6 commands.

The commands should be different depending on the service types so refer to the below table for proper application.

Items	Commands	Purposes
XGT client	Read	Reads the designated area of the opposing station.
	Write	Transmits its own station's area data to the opposing station.
User-defined frame	Send	Sends its own station's area data to the opposing station.
	Receive	Receives the transferred data from the opposing station and saves it.
Modbus TCP	Read	Reads the designated area of the opposing station.
	Write	Transmits its own station's area data to the opposing station.
E-mail	ESend	Transmits the message in case of occurrence of events.

#### 2) Kinds of P2P services

##### (1) XGT client

The XGT client service is used to define transmission and reception of data of XGB's built-in FEnet. For simple communication, a user only needs to designate the basic settings such as channels and data type (BIT,BYTE,WORD, etc.) and memory areas, etc. No. 2004 port is used for TCP and No. 2005 port is used for UDP.

##### (2) User-defined frame

It is the service that makes a user define other companies' protocols in XGB FEnet for communication between XGB's built-in FEnet and other XGT's FEnet I/F modules or communication with other models. The communication protocols may be different depending on the manufacturers. Through the function of user-defined frame, a user can apply and edit the frames according to the characteristics of the relevant communication modules. The basic structure of user-defined frame is composed of HEAD, BODY, TAIL.

##### (3) Modbus TCP

XGB FEnet supports the Modbus protocol that is the industrial standards. The Port No. is fixed as 502.

### 1.7.4 How to set up P2P services

#### 1) Ethernet Driver

##### (1) Driver setting

The Ethernet Driver means the protocols that will work when the built-in FEnet is operated by the server. There are the XGT server and Modbus TCP/IP server for the built-in protocols. You can set the Ethernet Driver based on the protocols to be used when the opposing station reads the basic unit's data through the built-in FEnet or writes the data to the basic unit. In the majority of cases, the communication opposing station is usually MMI (or HMI). In this case, a user can communicate with the opposing devices by setting parameters without separate communication programming. The below figure shows the typical example of using the Ethernet Driver; communication with MMI PC. When the MMI PC requests the data, FEnet will respond.

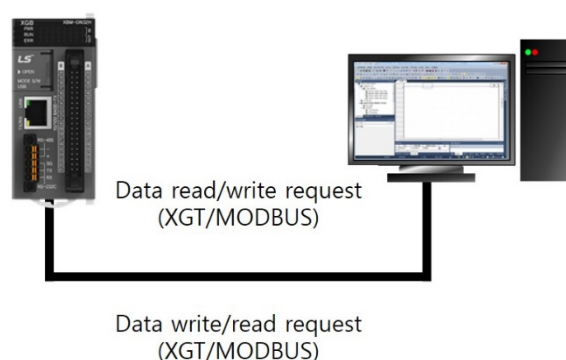

#### • Types of Ethernet (server) Drivers

The available driver types are as below.

Types	Descriptions
XGT server	LS ELECTRIC's XGT FEnet dedicated protocol
Modbus TCP/IP server	Modicon's open protocol

#### Notice

- (1) The number of drivers varies depending on the set Ethernet channels and if you set the Ethernet channels, the number of available drivers will be as small as the number of set channels. Accordingly, be careful of this.
- (2) The Ethernet (server) Driver can realize 1:N communication so several client devices can connect the one set port to obtain data.

2) P2P channel

The Ethernet P2P channel is used When the PLC is operated as Master by using XGT FEnet's built-in protocols or when the PLC should communicate through user-defined protocols

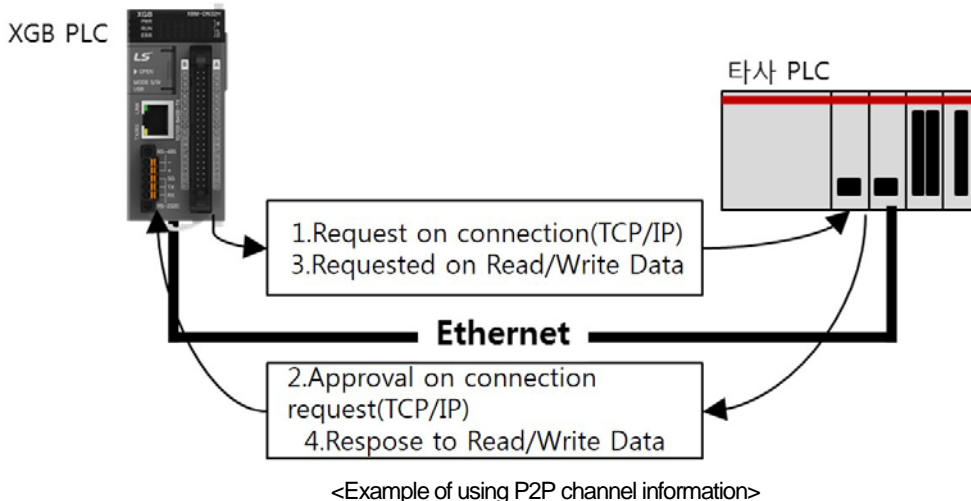

(1) P2P channel setting

The built-in FEnet can transmit and receive the data by using the maximum of 4 channels and the channel is composed of the IP address and port number of the communication device.

The number of available channels in P2P is the number that subtracts the number of dedicated accesses in the basic parameter from the total number of channels (4). (Number of P2P channels=4–number of dedicated accesses)

For user convenience, P2P allows the communication with the devices using XGT, Modbus TCP protocols by setting simple parameters. For communication with other devices, it provides the function of user-defined frames. In addition, a user can register the message and mail address to transmit and receive the E-mail frame. (It supports ASCII)

However, you do not need to set the channels for E-mail communication. If you choose the P2P channel in the window for P2P setting, the below window will pop up.

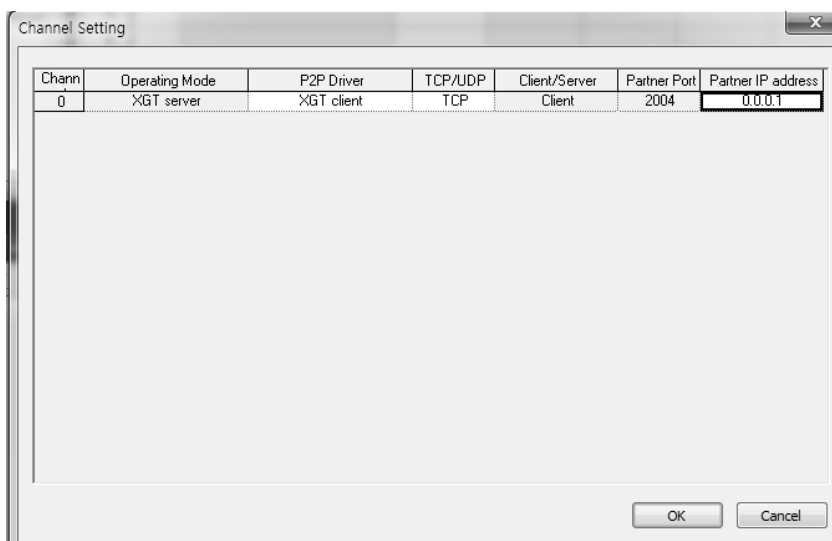

## Chapter 1 Built-in FNet communication

You can define the P2P driver type by selecting the 'P2P Driver' of the desired channel.

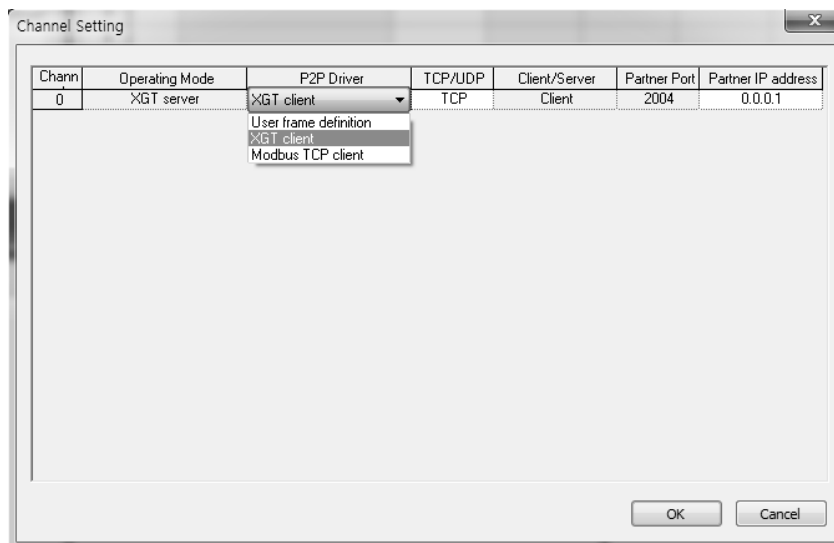

<Selection of P2P Driver client >

The below table shows the available driver types for the built-in FNet interface and the descriptions

Items		Descriptions
P2P Driver	User defined frame	It is the protocol defined by a user for communication with the opposing device.
	XGT client	XGT dedicated protocol. (No user-defined frame)
	Modbus TCP client	Defines the operations with MODICON's Modbus TCP protocols.
TCP/UDP		You can select between the TCP/UDP. If you select the Modbus TCP, it will be fixed as TCP.
Client/Server		You can select between the Client/Server. If you select the XGT dedicated protocol OR Modbus TCP, it will be fixed as Client.
Partner Port		You can input the opposing device's port number. It is the user-defined frame so when defining the protocols, the random port is designated and you can set the ports at the range of 1~65535. However, the XGT dedicated protocol is fixed as 2004 and the TCP is fixed as 502.
Partner IP Address		You can input the opposing device's IP address.

If you choose the XGT client or Modbus TCP client for the P2P Driver, you cannot apply the user-defined frame

### Notice

#### (1) Opposing station's IP address

In case XGT is client, make sure to set the server device's IP address. If the server is dynamically allocated the IP through DHCP, the IP address may be changed so you need to check the IP address before use.

3) How to use the Modbus Driver

The below table shows the commands and addresses of the Modbus devices.

Code	Names of function codes	Modicon PLC's data address	Remarks
01	Read output contact status (Read Coil Status)	0XXXX (bit-output)	Bit Read
02	Read input contact status(Read Input Status)	1XXXX (bit-input)	Bit Read
03	Read output register (Read Holding Registers)	4XXXX (word-output)	Word Read
04	Read input register (Read Input Registers)	3XXXX (word-input)	Word Read
05	Write output contact 1 bit (Force Single Coil)	0XXXX (bit-output)	Bit Write
06	Write output register 1 word (Preset Single Register)	4XXXX (word-output)	Word Write
15	Sequential Write output contact(Force Multiple Coils)	0XXXX (bit-output)	Bit Write
16	Sequential Write output register (Preset Multiple Register)	4XXXX (word-output)	Word Write

4) P2P block

If you choose the P2P block of the relevant parameter, the window for setting P2P parameters will be displayed.

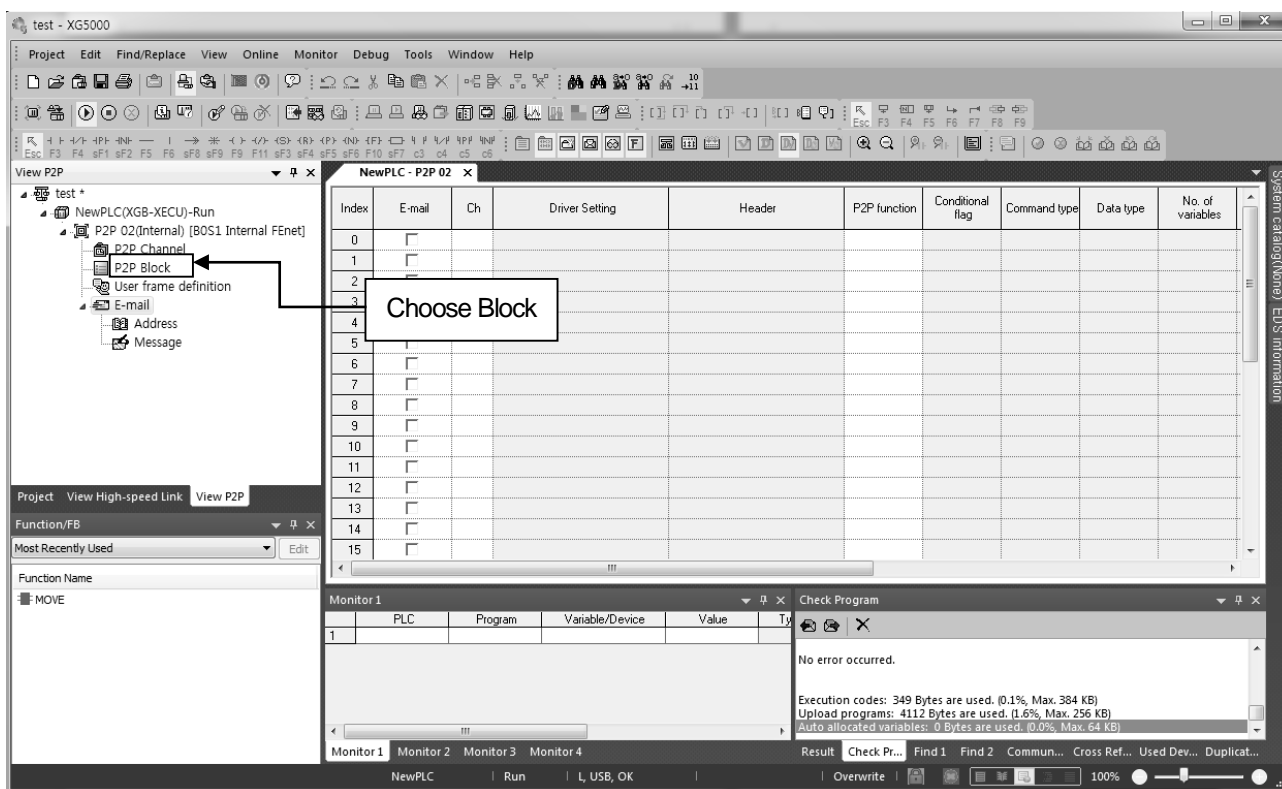

You can set up the independent blocks up to 32. If you choose the random block in XG5000, you can designate the operations of the relevant block by selecting functions as below.

Index	E-mail	Ch	Driver Setting	Header	P2P function	Conditional flag	Command type	Data type
0	<input type="checkbox"/>	0	XGT client	LSIS-XGT				
1	<input type="checkbox"/>							

The setting items by functions and the descriptions are as below.

(1) E-mail

It is used to set up the E-mail service.

## (2) Channel

You can select the communication port to be used for the relevant block. The communication port of each block is determined at the time of setting parameter and it cannot be changed during RUN. The maximum number of configurable channels is the number that subtracts the number of set dedicated accesses from total 16 communication modules 'basic settings' of XG5000.

## (3) Driver Setting

It means the communication driver designated by P2P setting. When designating channels, the driver for the relevant channel is automatically loaded. In case of arbitrary deletion of P2P channel setting, the set driver will be deleted. For more details, refer to 1.7.2 P2P channel.

## (4) P2P functions

You can choose the P2P functions depending on the set channel drivers. Read/Write data can be performed from the opposing station with the set drivers.

- For the XGT client, choose READ/WRITE.
- For the Modbus TCP client, choose READ/WRITE.
- For the user-defined frame, choose SEND/RECEIVE

## a) READ

It is the function to read and save the random area of the opposing station. It can be used for both the XGT client and the Modbus TCP client driver.

## b) WRITE

It is the function to write data in the desired area of the opposing station. It can be used for both the XGT client and the Modbus TCP client driver. It supports Sequential Write and Individual Write and it is possible to write data for the maximum of 4 individual areas.

## c) Send

It is the function to transmit the random frame to the external device to be accessed through unspecified communication not XGT client/Modbus TCP client protocol. It is applied to the user-defined frame.

You can select and use just one frame per one Frame Send. Through this function, you need to designate the fixed /variable sized variables of the relevant frames. Before using this function, you need to define the frame to be transmitted.

## d) Receive

It is the function to receive some frames among the frames that are sent to the opposing station. You cannot choose the same frame for each P2P Frame Receive function block. You can choose just one reception function block for the reception frame.

## (5) Conditional flag

It defines when the P2P block works and you can choose fixed cycle and memory set trigger conditions. Startup conditions are the internal contacts of XGB basic unit.

## (6) Command Type

You can determine the detailed operations of Read; you can choose between Individual Read and Sequential Read. Individual Read covers the maximum of 4 memory areas (XGT protocol) and Sequential Read covers the defined size at the designated position.



## (7) Data type

It defines the data type that will be processed by the blocks. In the case of XGT, it is possible to process data of bit, byte, 2 bytes (1 word), 4 bytes (double word), 8 bytes (long word).

## (8) Number of variables

It can be defined only when you choose Individual Read. It determines the number of areas to be read individually and in the case of XGT, you can choose them up to 4. In the case of Modbus, it is fixed as 1.

## (9) Data size

It defines the size of the data to be read when you choose Sequential Read and the data size is different depending on the data type.

## (10) Frame

You can select the relevant frame (group) setting that will perform communication when defining the user frame.

## (11) Setting

You can designate the memory area to be transmitted/received when setting XGT client or user definition. For transmission, as shown in the below figure, designate the area that will save the area (M0000) to be transmitted and the received data from the opposing station.

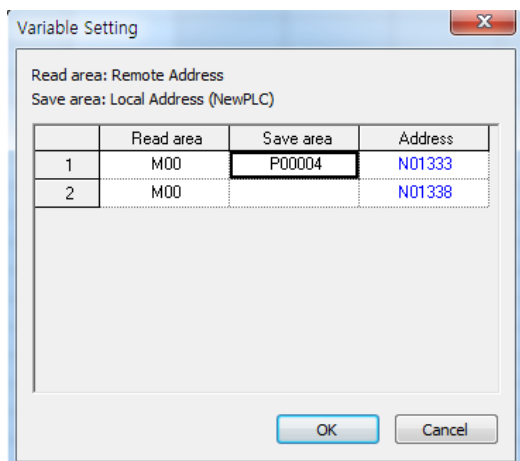

### 1.7.5 XGT client

XGT client is the function to Read/Write Data, which transmits the request frame to the server through XGT dedicated protocols. It transmits the frame when the startup conditions of each block set in parameters are On. In the case of XBL-EMTA, you can use the XGT client function in two ways; TCP and UDP.

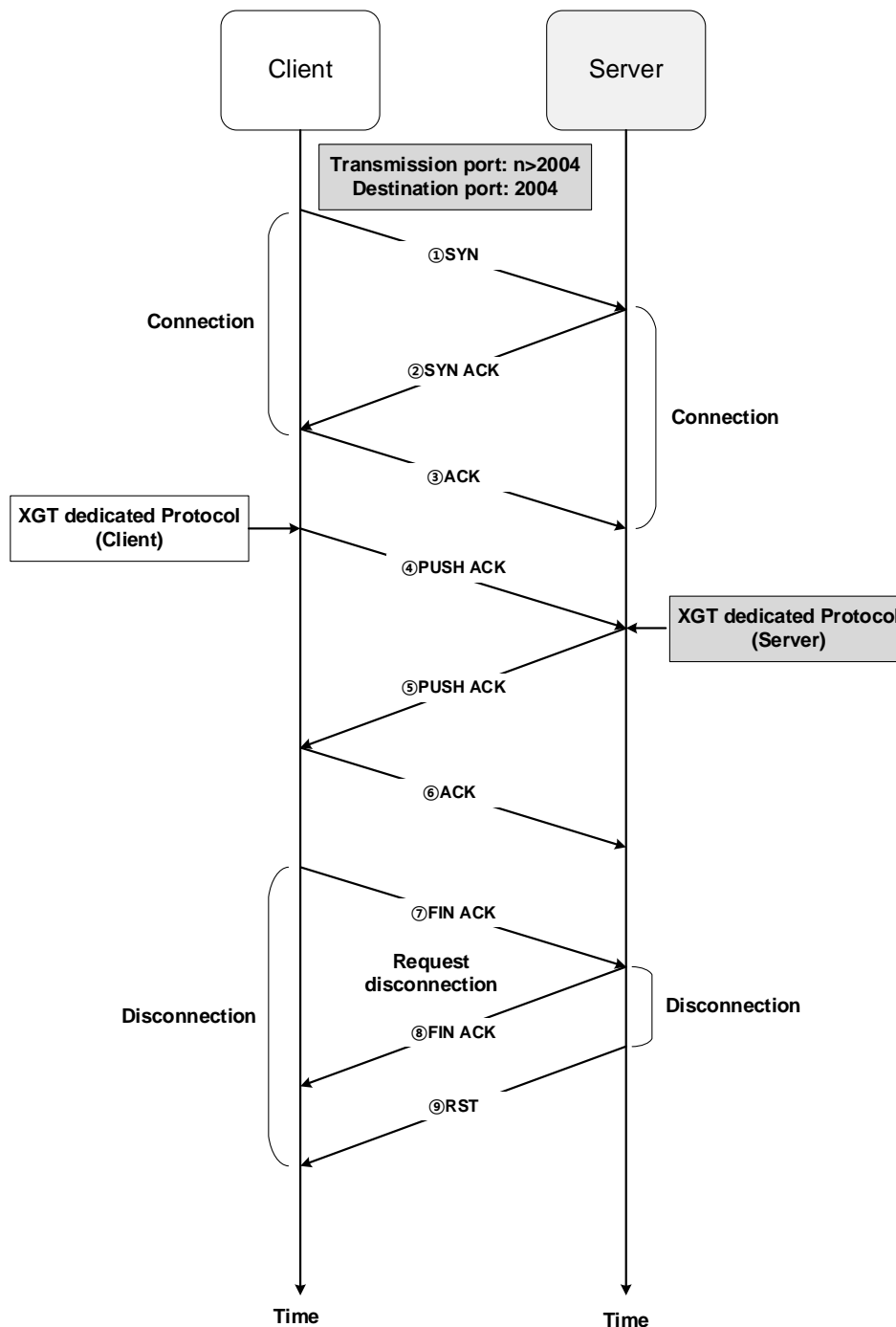

<Setting TCP XGT client channel>

### 1.7.6 Modbus TCP client

It is the function to Read/Write Data, which transmits the request frame to the server by using function code based on Modbus TCP/IP protocol. It transmits the frame when the startup conditions of each block set in parameters are On.

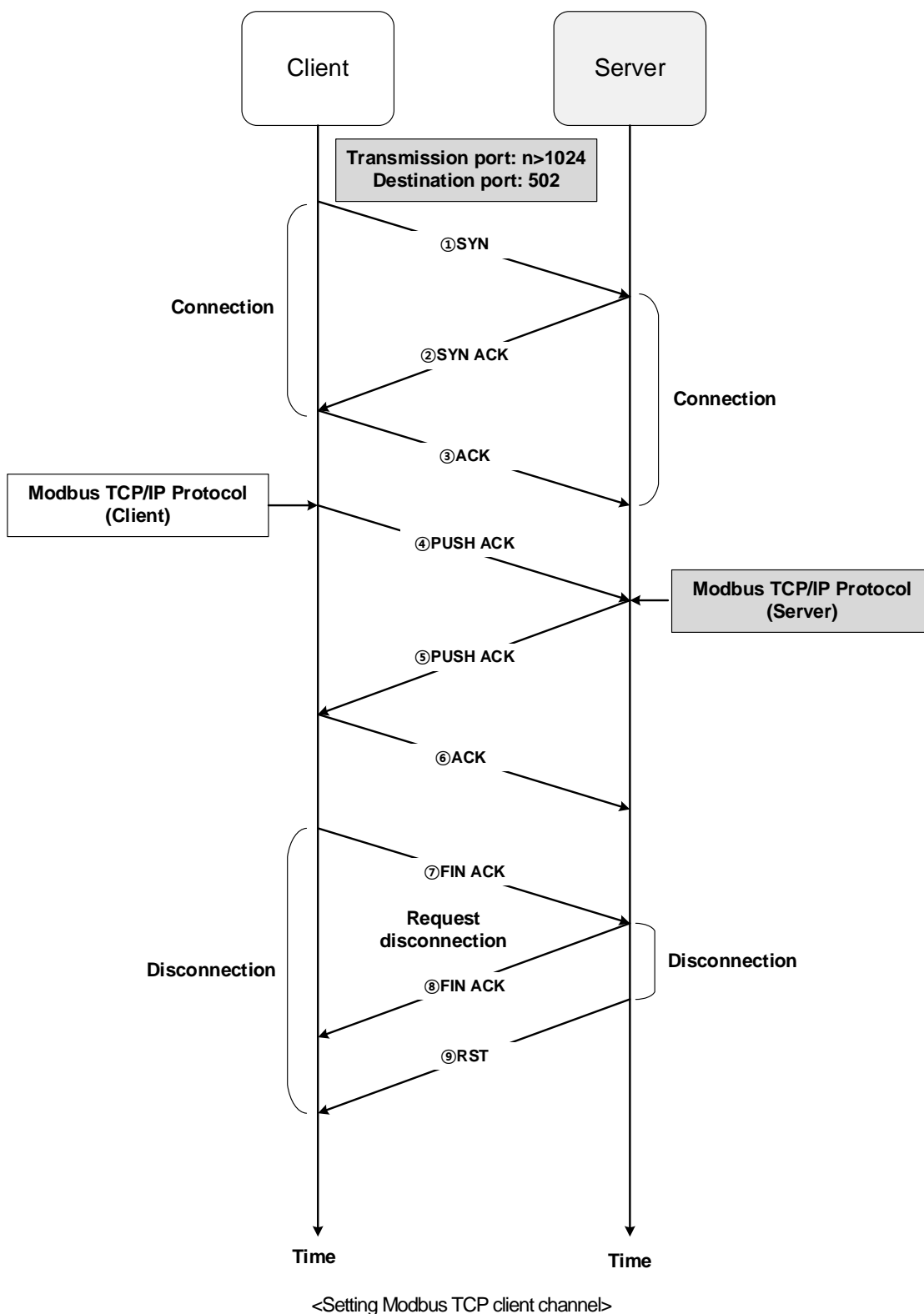

### 1.7.7 User-defined frame

If you want to transmit the user's desirable frame or receive one among the frames of the network, you need to define the relevant transmission/reception frame. The function is available in the P2P service only. All frames are composed of Header, Data, Tail and each element can be omitted.

The user-defined frame is expressed as the group name and frame name. Each meaning is as below.

#### 1) Group

It is the set of frames having the same Headers and Tails. To register frames, you need to register groups.

#### (1) Adding groups of user-defined frame

After choosing the user-defined frame as below, click the right mouse button. Select "Add a Group" in the popup menu for adding items.

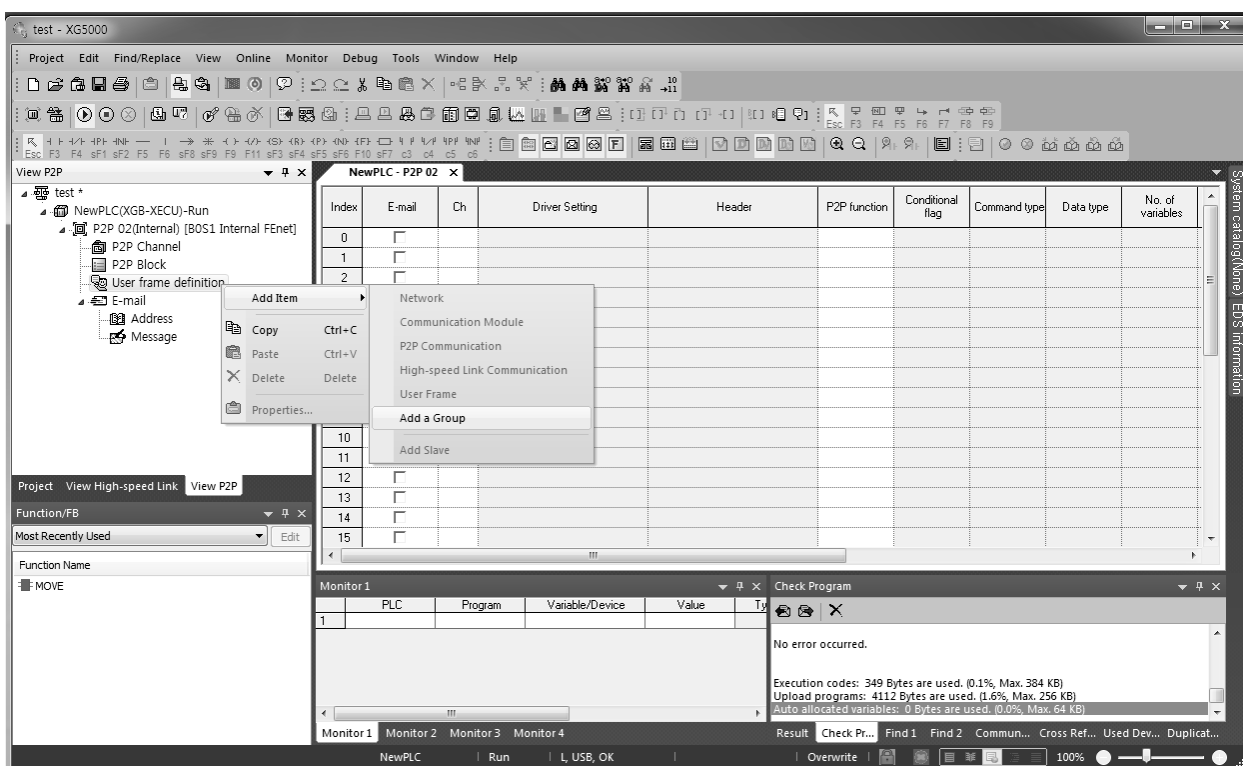

(2) Selecting group names and frame types of the user-defined frame

Enter the group name in the group edition menu and select the frame type. You can input the group name discretionally.



< Selecting group names and frame types of the user-defined frame >

The below figure shows the results of the project window when selecting “SEND” of the group name, transmission frame.

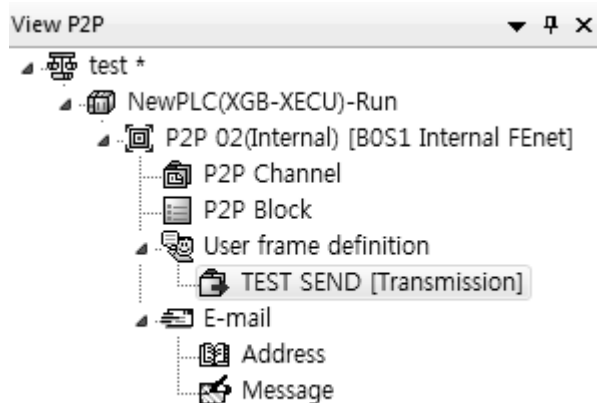

< Completion of adding groups of the user-defined frame >

2) Frame

- It is composed of the Head, Body, Tail.
- It defines the transmission · reception frames.
- You can add the fixed-variable sized variables to the Body.
- The frame is composed of multiple segments and you can register the maximum of 4 variable segments to one Body.

(1) Adding frames to the groups

If you click the right mouse button on the added group as below, the popup menu will come on. Choose 'Add Frames' and choose the frame types. The below figure represents the added frames to the group when you select HEAD, TAIL, BODY respectively.

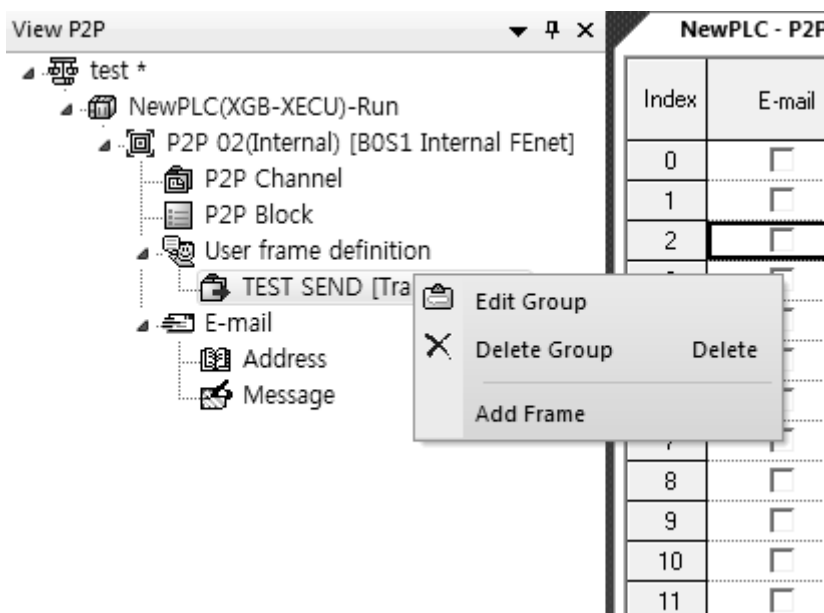

< Adding the transmission frame of the user-defined frame >

a) Adding the user-defined frame's HEAD

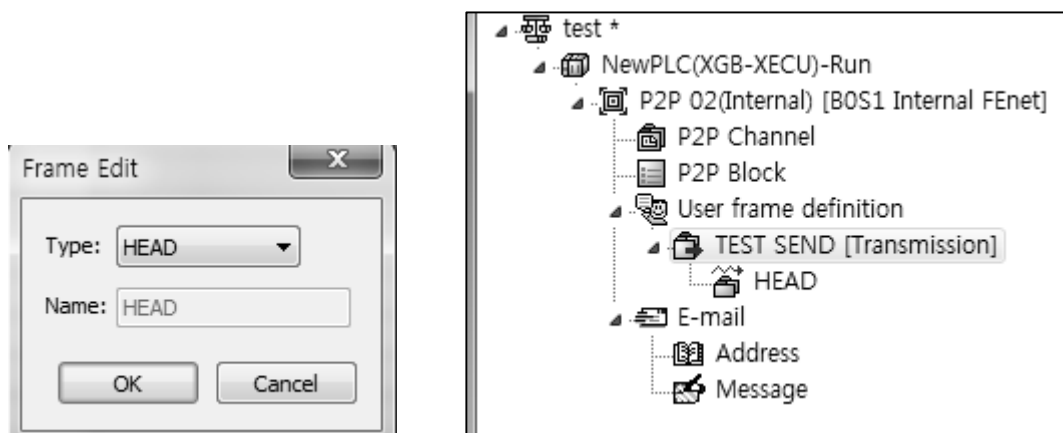

<Adding the use defined frame's HEAD>

(2) Adding the user-defined frame's TAIL

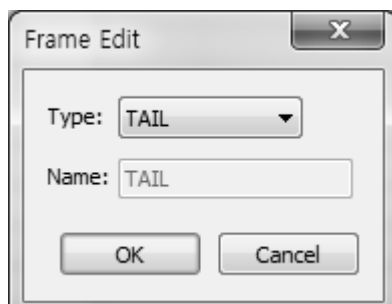

(3) Adding the user-defined frame's BODY

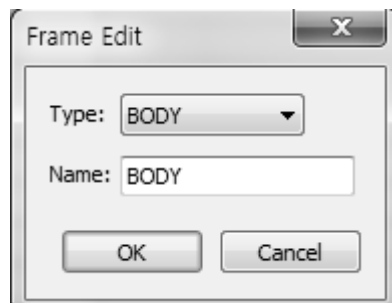

3) Segments

(1) Kind of segments

The frame's Headers, Bodies, Tails are composed of multiple segments. You can add segments by clicking the right mouse button.

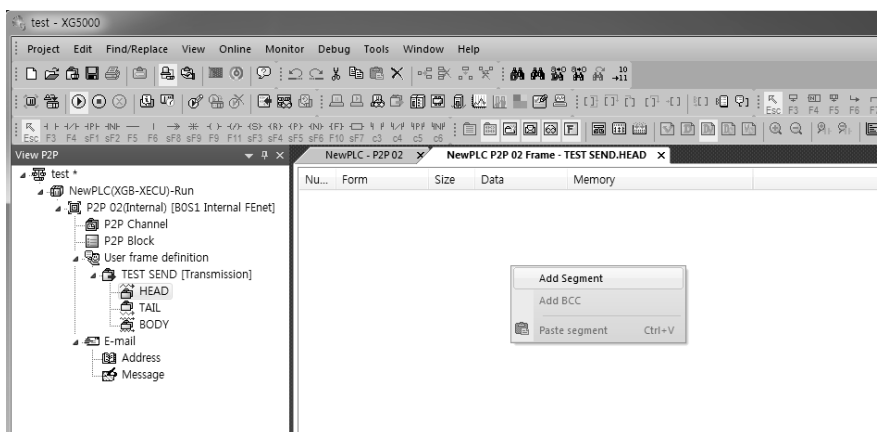

Number	Form	Size	Data	Memory
00	String Constant	4	1324	

< Example of the window where the segment is registered >

There are the numerical constant, string constant, fixed · variable sized variables for the segments forming the frames.

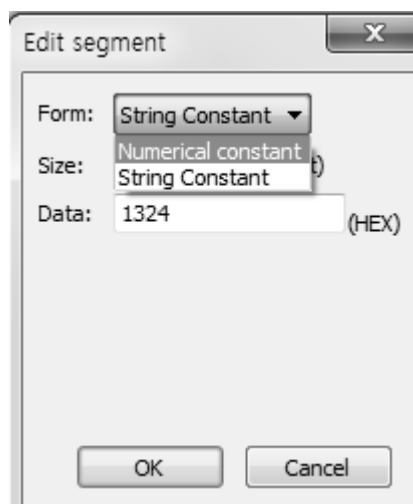

<Adding segment>

a) Numerical constant

It defines the part that is fixed as the constant among frames and the value of data term should be designated as Hex.

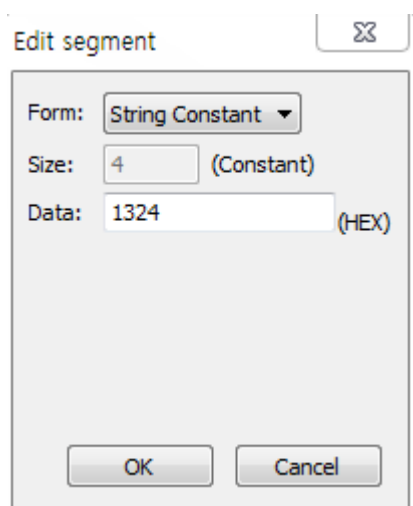



## b) String constant

Register the string constant among frames and designate the value of data term as ASCII.

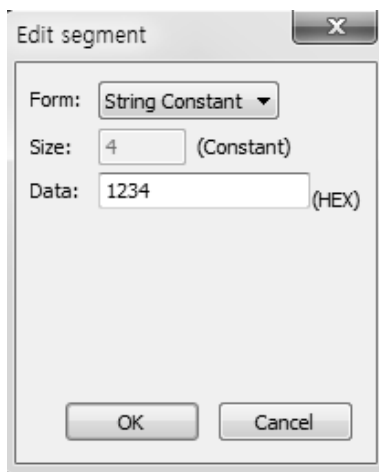

The 'Edit segment' dialog box shows the following configuration:

- Form: String Constant
- Size: 4 (Constant)
- Data: 1234 (HEX)

## c) Fixed size variables

The fixed size variables can be used for the frame's Body area only. It is used when you process the data as much as the defined size among the received frames. If you check memory specification, it can be saved to the PLC memory. At this time, data values can be changed, swapped.

## d) Variable size variables

- They can be used for the frame's Body area.
- Transmission frame: It is used to change the frame length. If you check memory specification, the transmission frame will be composed of the data read from the PLC memory.
- Reception frame

It is used to process variable sized data among received frames.

It can be registered to the last segment among the Body areas. If you check memory specification, the data for the corresponding segment will be saved among received frames (it also can be swapped and changed)

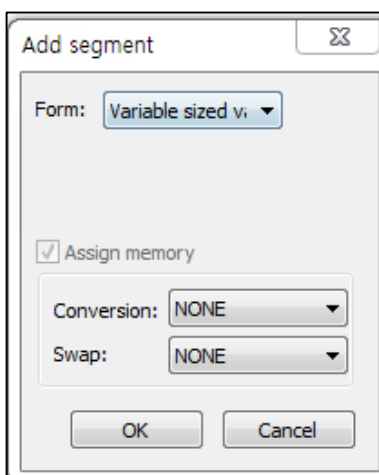

The 'Add segment' dialog box shows the following configuration:

- Form: Variable sized v...
- Assign memory
- Conversion: NONE
- Swap: NONE

## (2) Data conversion processing

In case you need to convert the data into ASCII from Hex during transmission-reception of frames or execute Byte Swap, it can be defined in the frame editing frame.

## a) Conversion

## (a) Hex To ASCII

- Transmission: Converts the data read from the PLC memory into ASCII and composes the transmission frame
- Reception: Converts the received data into ASCII and saves it.

## (b) ASCII To Hex

- Transmission: Converts the data read from the PLC memory into Hex and composes the transmission frame.
- Reception: Converts the received data into Hex and saves it.

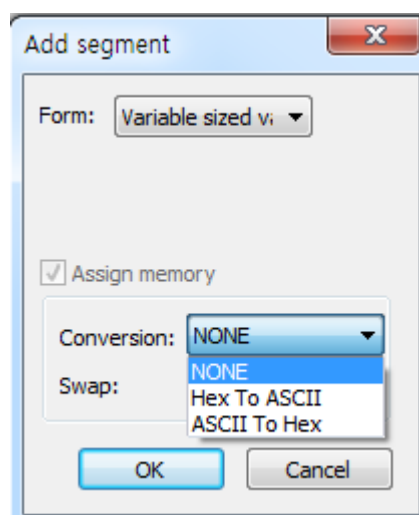

For configuring the transmission frame, in CASE you use the PLC memory MW100's 2word and convert it into Hex to ASCII or in case h34353637 is saved in MW100, the corresponding segment of the transmission frame will be made of "4567".

In addition, when you convert the part of the received frames into Hex and save it, if the value of the corresponding area is "4567", h34353637 will be saved to the PLC memory.

## b) Swap

## (a) 2byte

- Swapping the corresponding part of transmission · reception frames by 2 bytes

## (b) 4byte

- Swapping the corresponding part of transmission · reception frames by 4 bytes

## (c) 8byte

- Swapping the corresponding part of transmission · reception frames by 8 bytes

\* h1234567811223344 can be converted by each method as below.

- 2byte Swap: h3412785622114433
- 4byte Swap: h7856341244332211
- 8byte Swap: h4433221178563412

4) TCP/UDP user-defined frame server

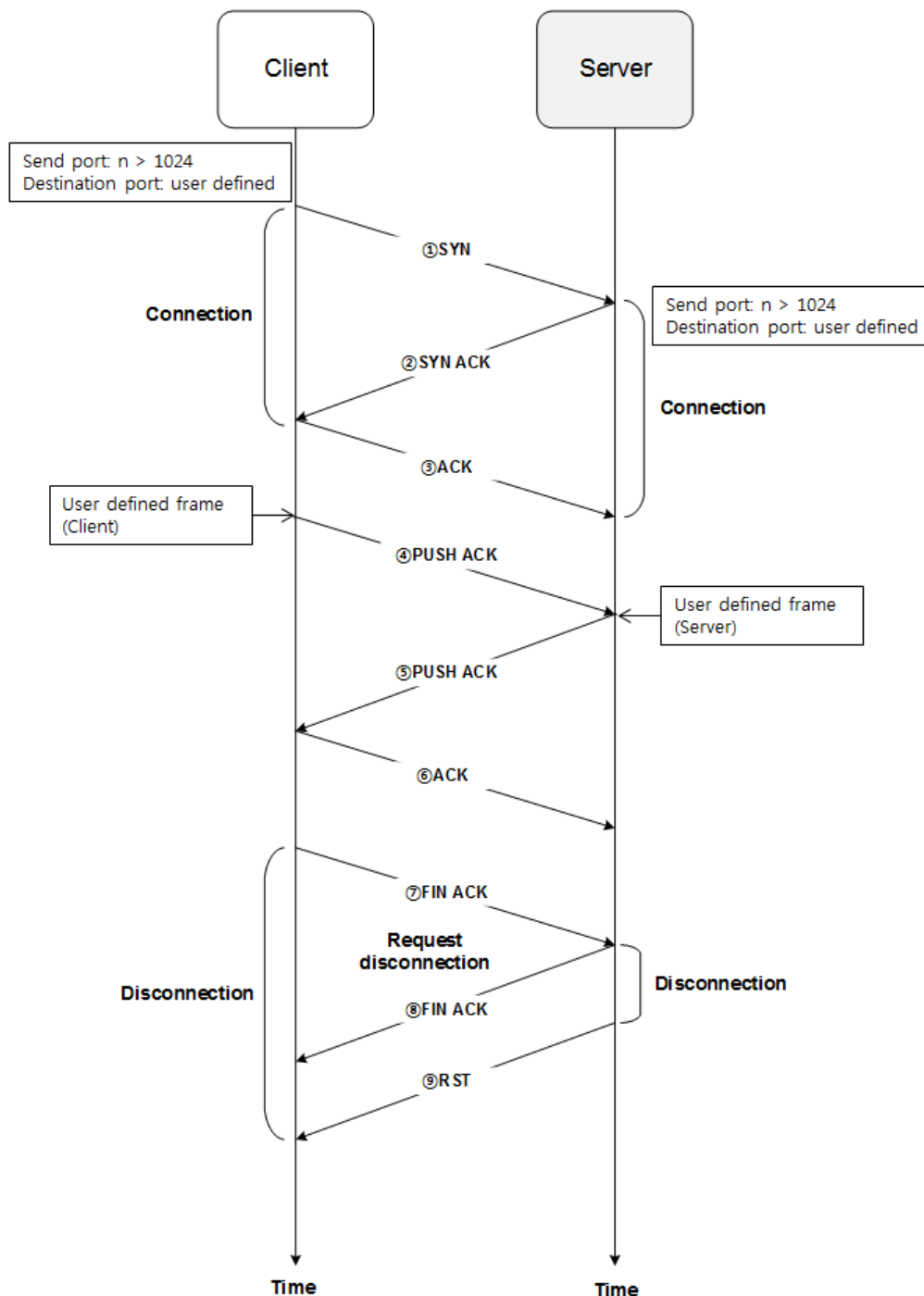

▪<TCP user-defined frame server>

- (1) It is the function to receive the frame registered in the transmission block to the port designated by a user.
- (2) After the access request is received from the client and connection is completed, when the frame registered in the reception block is received from the client, the corresponding block will be processed.
- (3) In case the ports or frame forms are different, reception process is not available.
- (4) In the case of UDP user frame server, when the frame registered in the reception block is received to the port, it will be processed.

5) TCP/UDP user-defined frame client

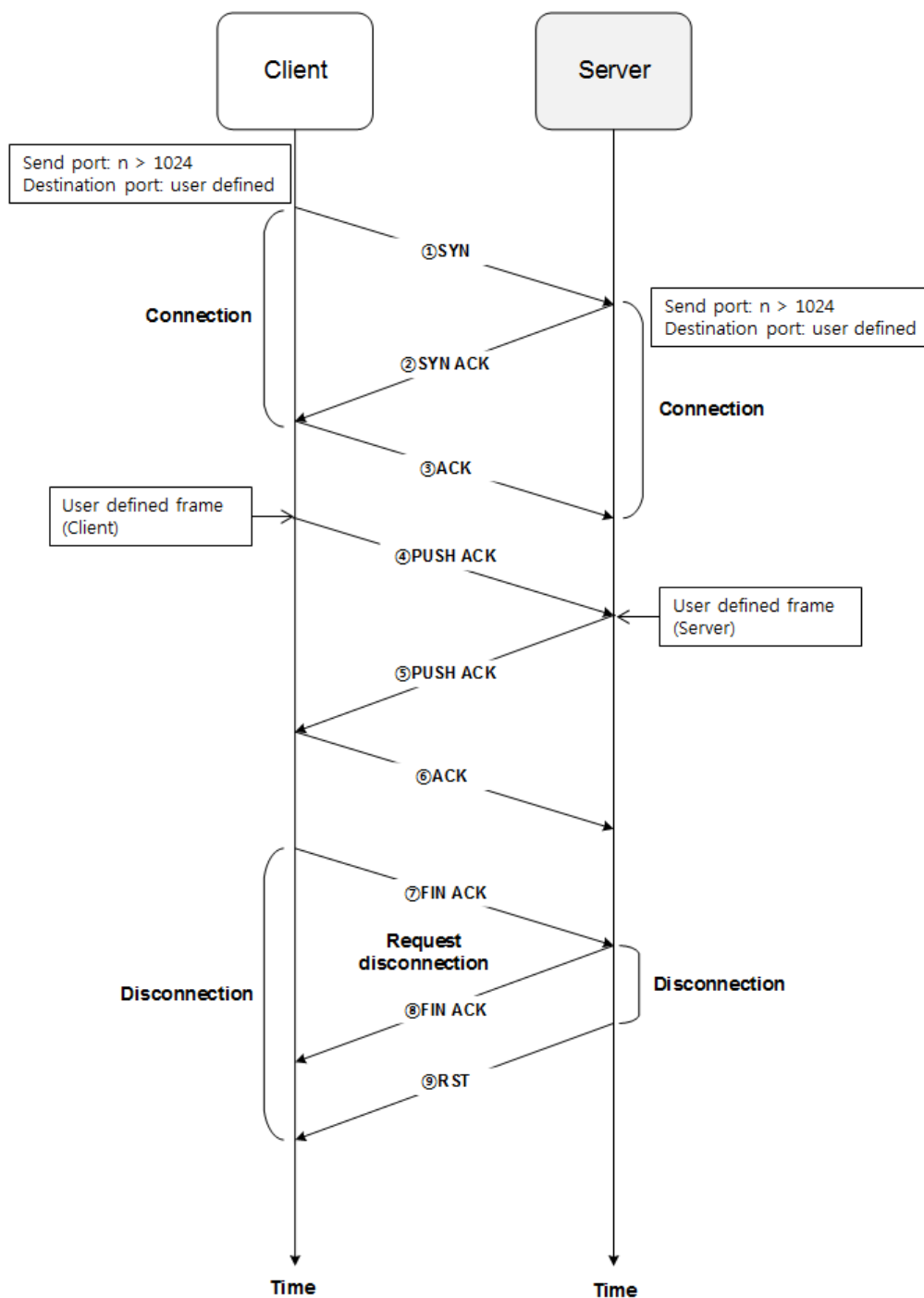

<TCP user-defined frame client>

- 1) It is the function to transmit the frame that is registered in the transmission block to the port designated by a user.
- 2) If the startup conditions of the block are On, the connection request will be sent to the server and the frame registered in the transmission block will be sent to the corresponding port.
- 3) In the case of UDP, when the startup conditions are On to the corresponding port without connection request, the frame will be transmitted.

### 1.7.8 Operation of P2P service

After setting P2P parameters, you need to download the parameters to the PLC's CPU and start up the P2P service. Assume that the P2P parameters to be downloaded are already made and accesses to the PLC's CPU.

#### 1) P2P parameter download

If you choose [Online] -> [Write] in the XG5000 menu to download the completed P2P parameters, the window for parameters download will pop up. If you click the 'OK' button, the communication parameters will be downloaded to the CPU. if you check 'Set up with Link Enable', Link Enable can be applied with writing P2P/HS parameters at the same time.

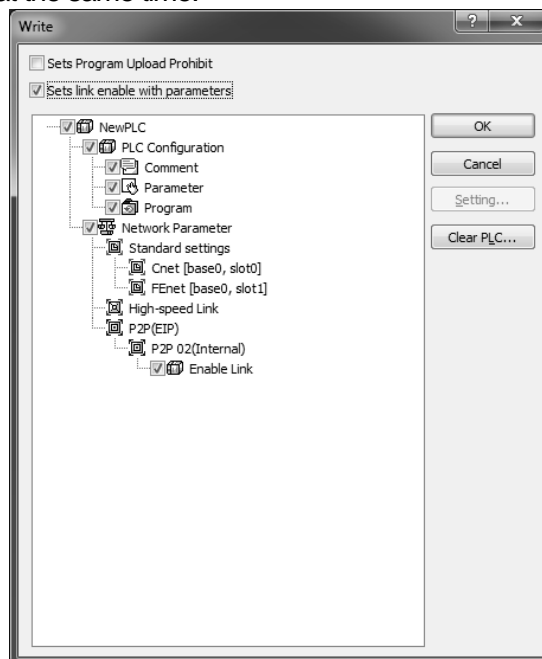

## (1) Startup of P2Pservice

After downloading P2P parameters, you need to start up P2P for P2P service. To achieve this, choose [Online] → [Communication Module Setting] → [Link Enable (high speed link, P2P)] in the menu.

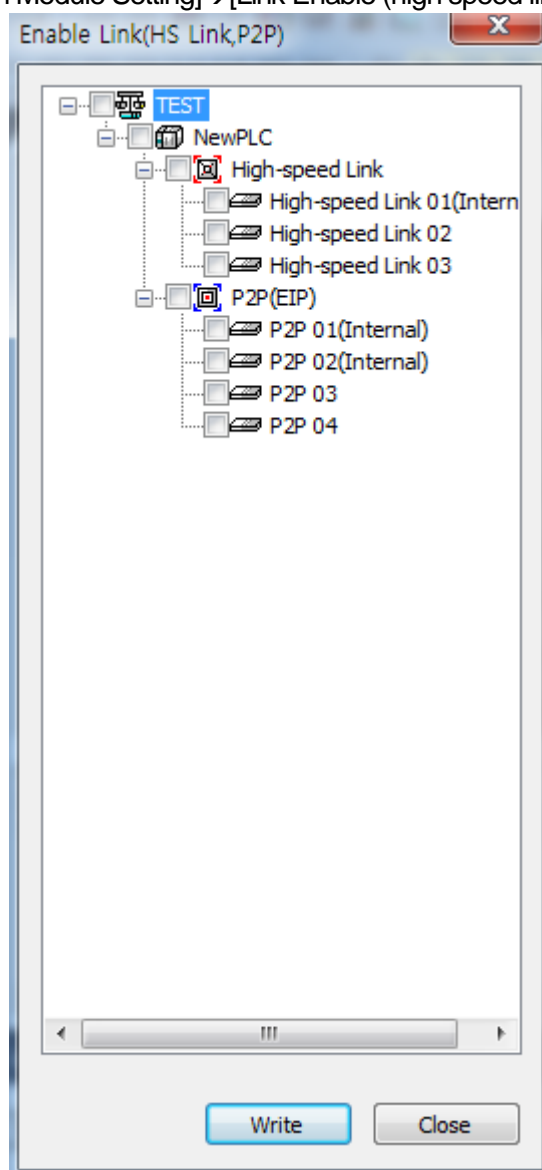

Choose the P2P parameters to be started in the [link Enable (high speed link, P2P)] window. If you cancel the already checked P2P parameter, the relevant P2P service will stop.

### 1.7.9 P2P diagnosis function

- 1) Click the System Diagnosis as shown in the left figure after access through XG5000.
- 2) Then, the current system is displayed as shown in the right figure.

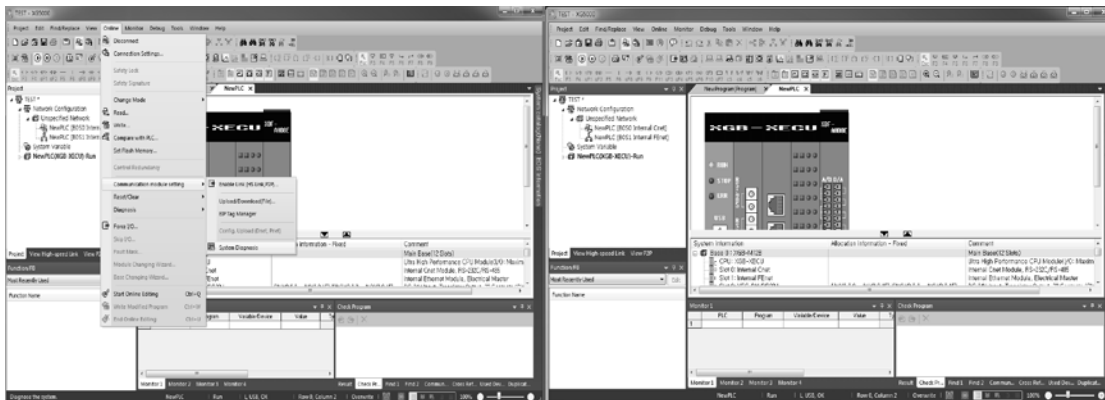

- 3) Put the mouse on the figure of the module and click the right mouse button as shown in the left side of the below figure.
- 4) Choose the status by services and click them.

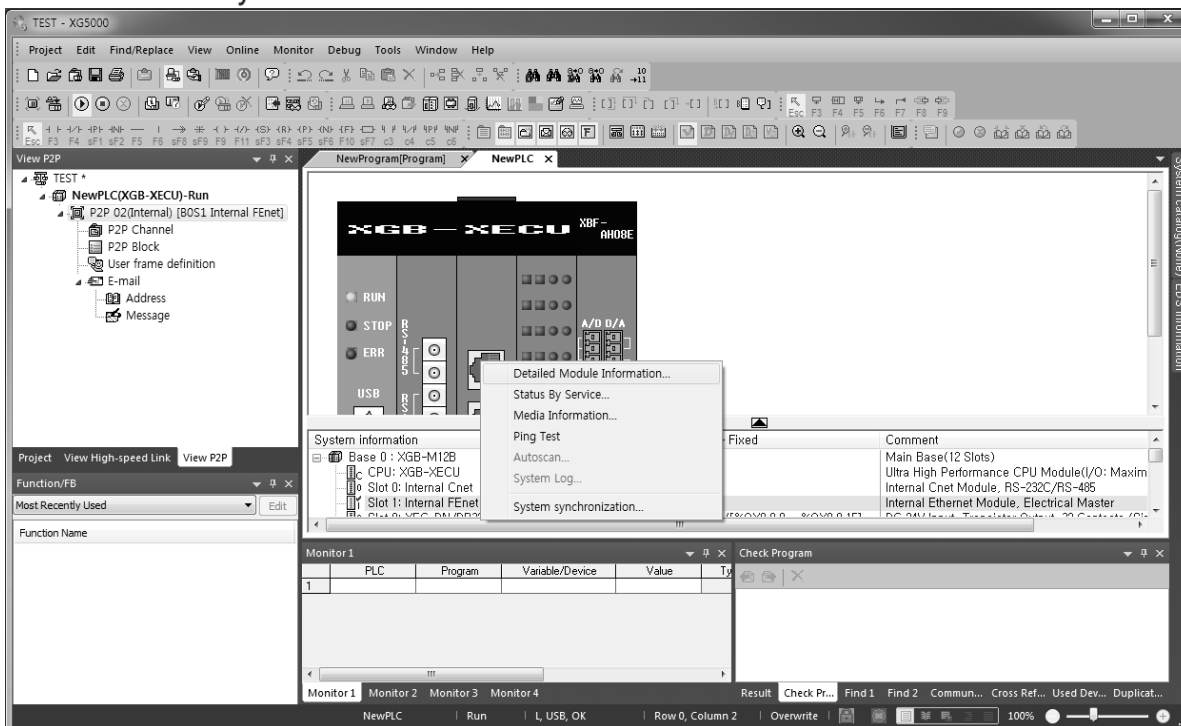

## Chapter 1 Built-in FNet communication

5) Then, the status window by service is displayed.

6) If you select the P2P service tab, you can check the status of P2P service as below.

The screenshot shows a window titled "Status by service" with three tabs: "Dedicated Service", "P2P Service", and "HS Link Service". The "P2P Service" tab is selected. The window is divided into several sections:

- Standard Information:** Base No.: 0, Slot No.: 1
- Service Information:** Parameter existence: exist, Parameter task status: IDLE, No. of blocks in service: 4
- Communication Diagnostics:** A table with 7 columns: Block number, Channel number, Block status, Connection status, Service status, Service count, and Error count. The table contains 4 rows of data, all showing "IDLE" connection and service status.

At the bottom right of the window, there are buttons for "Multiple Reading", "Refresh", and "Close".

Block number	Channel number	Block status	Connection status	Service status	Service count	Error count
0	0	0	IDLE	0	0	0
1	0	0	IDLE	0	0	0
2	0	0	IDLE	0	0	0
3	0	0	IDLE	0	0	0

### Remarks

We support Dedicated Service in case of Only TCP client which Connected to XGT server  
 Dedicated Service not available in XGT Server(UDP)



## 1.8 High speed link

### 1.8.1 Outline

The high speed link that is the communicate method between XGB PLC and XGK PLC's communication module is the function to transmit and receive data regularly by setting high speed link parameters. The high speed link service transmits the frame to Subnet Broadcast by using UDP protocols.

The device that is in the same subnet receives the Broadcast frame and if the relevant frame is registered in the reception list, the data will be processed. The functions of the high speed link are as below.

- 1) Function for setting the high speed link block  
If there are several transmission · reception areas, you can set the blocks up to 64. It is possible to set 200 words per one block.
- 2) Function for setting the transmission cycle  
A user can set the transmission cycle by parameters. It is possible for a user to set the transmission · reception cycle from 20ms to 10 seconds.
- 3) Function for setting transmission · reception areas  
You can set the transmission · reception areas by data blocks. It is possible to use the maximum of 64 blocks without distinction of transmission · reception.
- 4) Function for providing the high speed link information  
You can check the operating status of the high speed link through flags.  
You also can use the convenient diagnosis function through XG5000.

### 1.8.2 Parameters setting

#### 1) Basic parameters

- (1) When creating the XG5000 project, any RUN communication modules are not registered in the basic network.

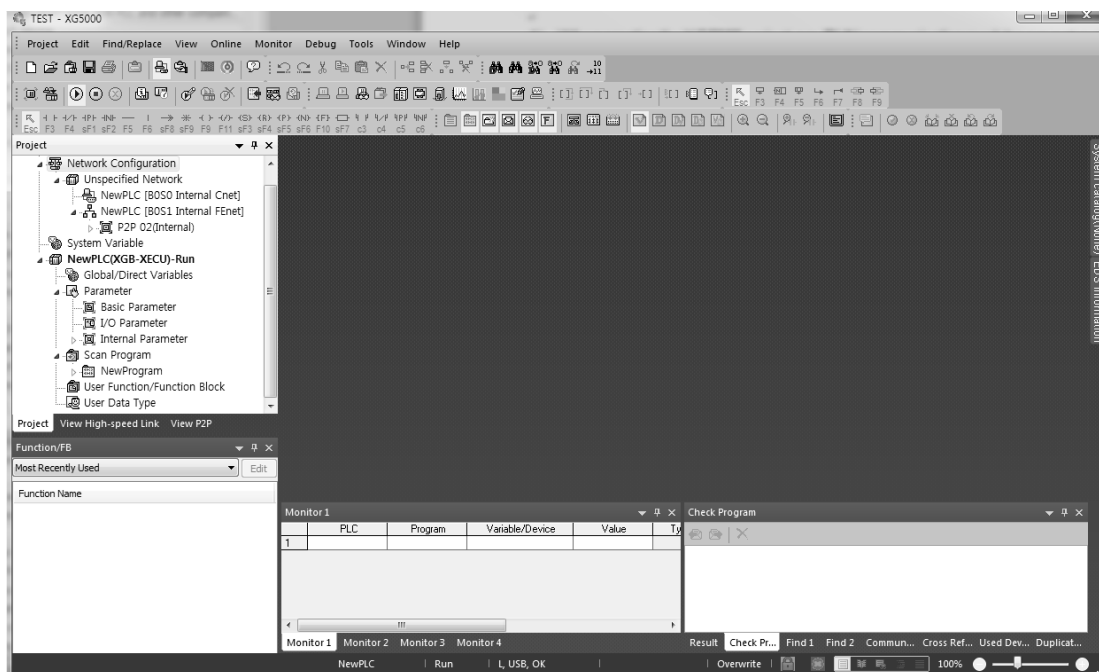

[Fig. 1.8.1] Creation of XG5000 project

## Chapter 1 Built-in FNet communication

- (2) If you execute I/O synchronization in [online]→[diagnosis]→[I/O information] after accessing to the PLC, even the currently installed expansion communication module including built-in communication will be registered.

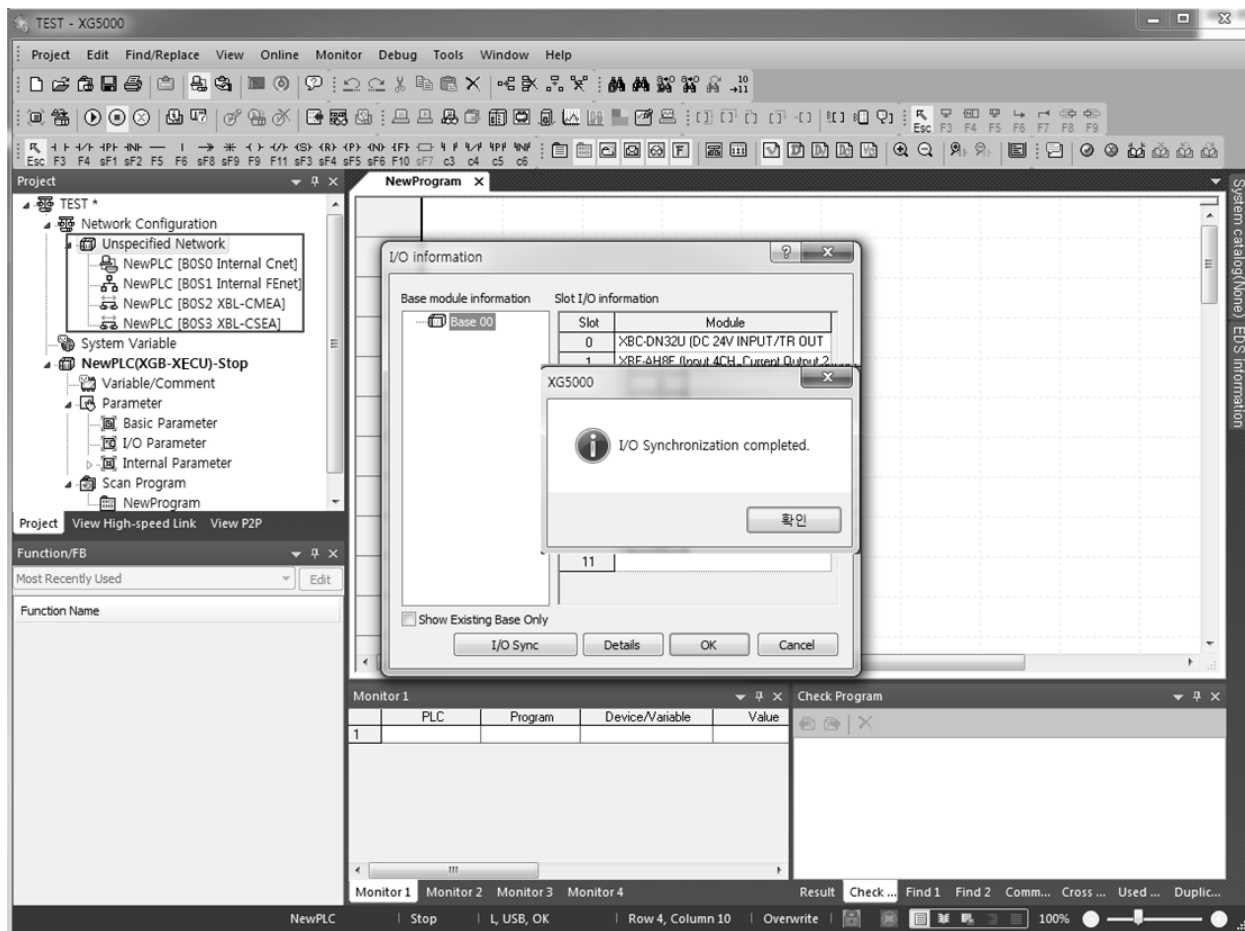

[Fig. 1.8.2] Registration of XG5000 project communication module

- (3) Double-click the built-in Fenet and input high speed link's exchange number and network parameter information.

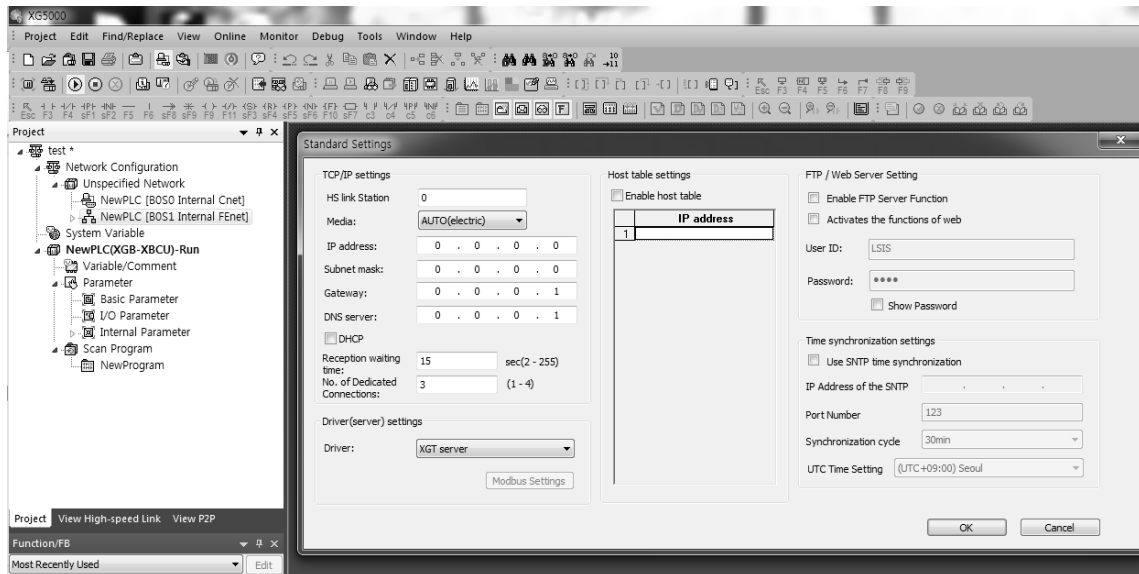

[Fig. 1.8.3] Setting the basic communication module

2) High speed link parameter  
(1) Communication setting

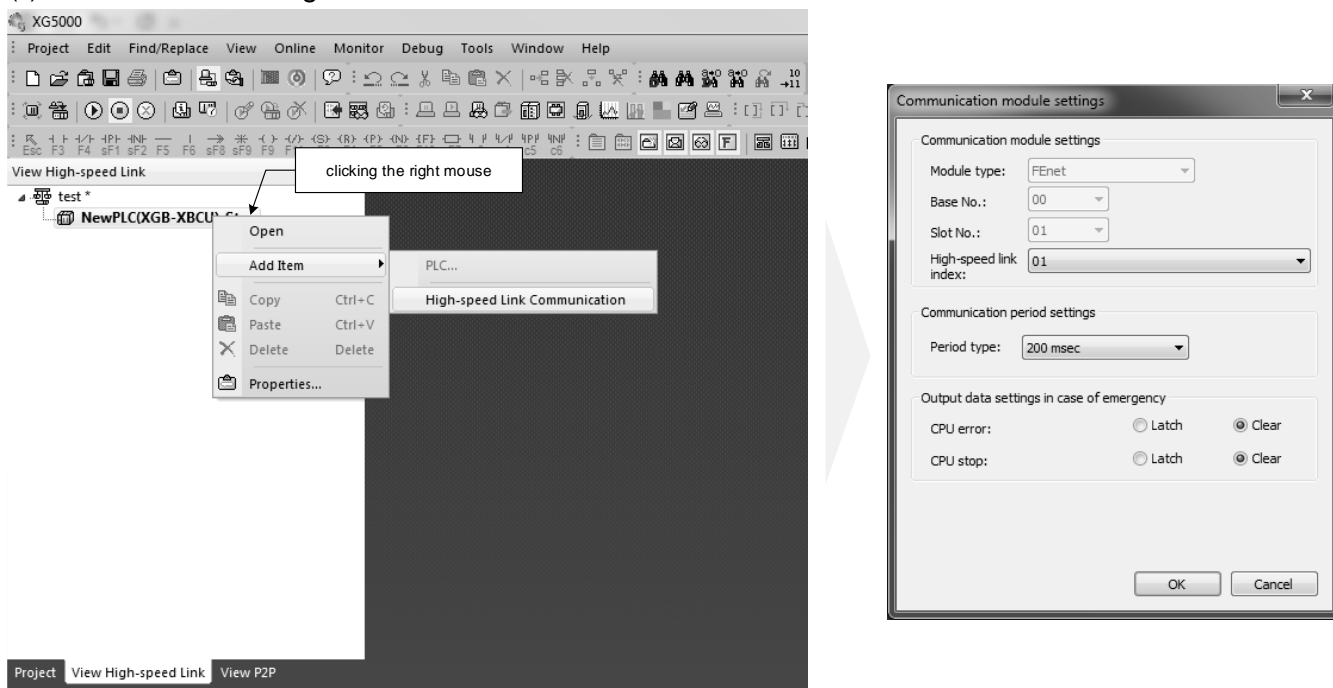

[Fig. 1.8..4] Basic setting of high speed link

- a) After clicking the right mouse on the high speed link tab, add high speed link communication items as shown in the left side of the figure[1.8.4].
- b) Then, the window for setting communication modules is activated as shown in the right side of the figure[1.8.4] and you can set the basic high speed link. No.01 high speed link is the built-in FEnet and No. 02 and 03
- c) high speed links can be used for expansion communication modules as before.

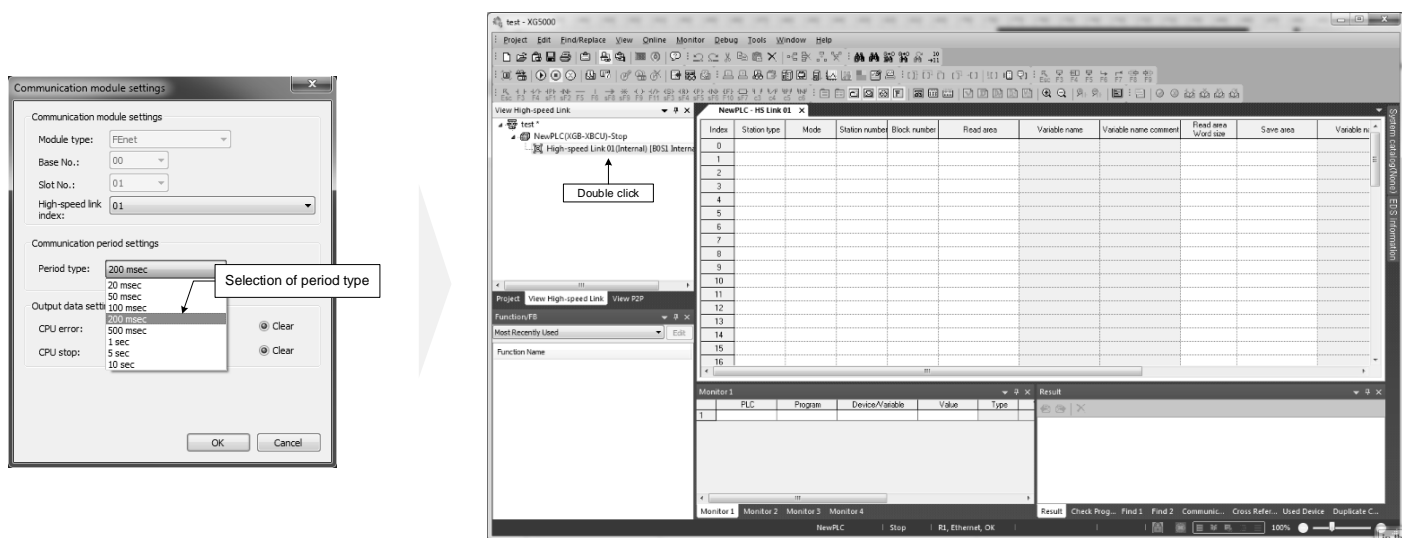

[Fig. 1.8.5] Completion of setting high speed link communication module

- d) Select the cycle to be communicated in communication cycle setting as shown in the left side of [Fig. 1.8.5].
- e) Choose the cycle and click 'OK' button. Then, if you double-click the No.1 module of high speed link, the window for setting block will be displayed as shown in the right side of [Fig. 1.8.5].

## (2) Setting the high speed link transmission block

Index	Station type	Mode	Station number	Block number	Read area	Variable name	Variable name comment	Read area Word size	Save area	Variable name	Variable name comment	Save area Word size
0	MASTER	Send	1	0	M0000			10				
1												
2												
3												
4												
5												
6												
7												
8												
9												
10												
11												

[Fig. 1.8.6]Setting high speed link transmission block

- a) Set the station type as MASTER
- b) Choose the transmission mode
- c) If you choose transmission, it will be automatically set as the exchange number set in the basic parameters.
- d) Input the block number(range: 0~31).
- e) Input the area to be read.The area to be read is the each area of XGB's CPU modules.
- f) If you input the word size of the area to be read, setting transmission blocks is completed.

(3) Setting high speed link reception block

Index	Station type	Mode	Station number	Block number	Read area	Variable name	Variable name comment	Read area Word size	Save area	Variable name	Variable name comment	Save area Word size
0	MASTER	Receive	10	1					M0020			10
1												
2												
3												
4												
5												
6												
7												
8												
9												
10												

[Fig. 1.8.7] Setting high speed link reception block

- a) Set the station type as MASTER as show in [Fig. 1.8.7].
- b) Choose the mode as reception.
- c) Input the exchange number. This one is the exchange number of the opposing device transmitting the relevant block.
- d) Input the block number. When the received frame is the same as the relevant block number, reception is processed.
- e) Input the storage area. The storage area is the area saving data when the frames of the relevant block
- f) Numbers are received to each area of XGB CPU modules.
- g) If you input the word size of the data to be read, setting reception block is completed.

## (4) HS parameter download

If you choose [Online] -> [Write] in the XG5000 menu to download the completed HS parameters, the window for parameters download will pop up. If you click the 'OK' button, the communication parameters will be downloaded to the CPU. If you check 'Set up with Link Enable', Link Enable can be applied with writing P2P/HS parameters at the same time.

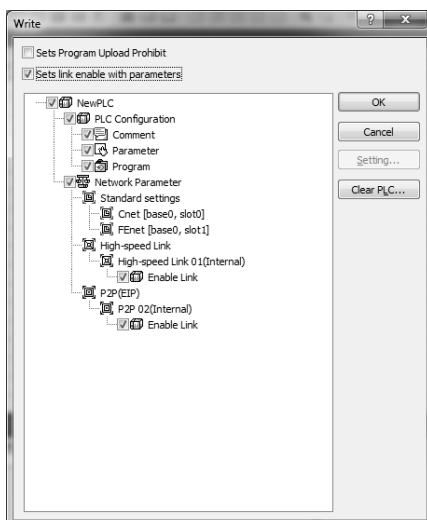

## (5) High speed link Enable

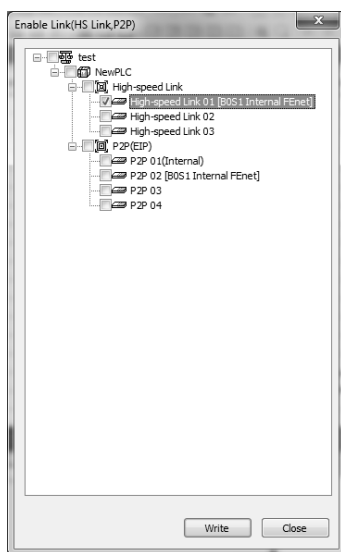

a) Choose [Online] -> [Communication module setting] -> [Link Enable] after accessing to the PLC through XG5000.

b) Choose high speed link 01 that built-in FNet is designated as the base.

c) After clicking the checkbox, click 'Write' button.

d) If you click the 'OK' button after the message is output, high speed link communication will start.

### 3) High speed link flag

The high speed link service is the function for data exchange between communication modules of more than two stations. For a user's information, it provides the way how to check the status of the high speed link service aiming to verify the reliability of the data read from the opposing station through the high speed link.

For the high speed link information, the communication module inform a user whether the high speed link is operated based on the parameters set by the user by synthesizing received data every a certain time.

The high speed link information can be divided into RUN-link (`_HSxRLINK`) showing the information of the whole communication network; Link-Trouble (`_HSxLTRBL`)'s whole information; `_HSxSTATUS`, `_HSxTRX`, `_HSxMOD`, `_HSxERR`'s individual information showing the communication status by 64 registered items of the parameters.

A user can use the above information during programming in the format of keywords and monitor the status of the high speed link by using the monitoring function. When operating several PLCs with the high speed link, you need to verify the reliability of the transmitted/received data by using the high speed link information such as RUN-link, link-Trouble, etc.

[Table 1.8.1] shows the functions and definitions of the high speed link information.

Items	RUN-Link	Link-Trouble	Transmission · reception status	Operation mode	Error	Status of high speed link
Information type	General information	General information	Individual information	Individual information	Individual information	Individual information
Keyword name (x=high speed link No.)	<code>_HSxRLINK</code>	<code>_HSxLTRBL</code>	<code>_HSxTRX[n]</code> (n=0..64)	<code>_HSxMOD[n]</code> (n=0..64)	<code>_HSxERR[n]</code> (n=0..64)	<code>_HSxSTATUS[n]</code> (n=0..64)
Data type	Bit	Bit	Bit-Array	Bit-Array	Bit-Array	Bit-Array
Monitoring	Available	Available	Available	Available	Available	Available
Use of programs	Available	Available	Available	Available	Available	Available

[Table 1.8.1] High speed link flag

#### (1) RUN link flag

It is the whole information showing whether the high speed link works normally based on the parameters set by the user. It is the contact that maintains the status of 'On' until Link Enable is 'Off' once it is 'On'. It is 'On' under the following conditions.

- In case Link Enable is 'On'.
- In case all parameter registering lists are set normally
- In case all relevant data is transmitted and received to the parameter registering list based on the set cycle.
- In case the status of all opposing stations set in the parameters is RUN with no error.

#### (2) Trouble link flag

It is the information showing whether the high speed link works normally based on the parameters set by the user. Under the situation of RUN-link On, when the conditions of RUN-link On are violated, it will be 'On'; when the conditions are recovered, it will be 'off'.



(3) Flag displaying the general status of the blocks

It is the individual information showing the operating status of the resisted lists of the high speed link parameters. It displays the status of high speed link by registered lists up to 64 like the maximum number of registrations. It displays the general information for the registered lists by synthesizing individual information of each item. When the transmission · reception status of the relevant list is normal and the operation mode is RUN with no error, it will be 'On'; when the above items are violated, it will be 'Off'.

(4) RUN operating mode flag of the block station

It is the individual information showing the operating status of the resisted lists of the high speed link parameters. It displays the operating mode information by registered lists up to 64 like the maximum number of registrations. When the station of the registered items is under Run mode, the relevant bit will be 'On'; when the station is under Stop/Pause/Debug mode, it will be 'Off'.

(5) Flag displaying the block station and normal communication

It is the individual information showing the operating status of the resisted lists of the high speed link parameters. It displays the transmission · reception information of the registered list up to 64. When the transmission · reception operation works based on the cycle, the relevant bit will be 'On'; when the operation does not work normally, it will be 'Off'.

(6) Operation error mode flag of the block station

It is the individual information showing the operating status of the resisted lists of the high speed link parameters. It displays the error information of the registered list up to 64 the maximum number of registrations. The error synthetically indicates the situation that the PLC cannot execute the user programs normally. When it is Off, it means the opposing station's PLC works normally; when it is On, it means the opposing station is abnormal.

## Chapter 1 Built-in FNet communication

### 4) Limitation of the high speed link's transfer rate

The below table indicates the limitation guaranteeing the high speed link's transmission speed. When you set the high speed link, refer to the below table to determine the communication load. In case of going out of the limitation, the data may be transferred, exceeding the transmission cycle.

(Communication speed: 100Mbps)

Based on 200 words per block			Based on 100 words per block			Based on 50 words per block		
Cycle	Scan time	Blocks No.	Cycle	Scan time	Blocks No.	Cycle	Scan time	Blocks No.
20 ms	Less than 1 ms	12 blocks	20 ms	Less than 1 ms	24 blocks	20 ms	Less than 1 ms	32 blocks
	Less than 2 ms	8 blocks		Less than 2 ms	16 blocks		Less than 2 ms	32 blocks
	Less than 5 ms	4 blocks		Less than 5 ms	8 blocks		Less than 5 ms	16 blocks
	Less than 10 ms	1 block		Less than 10 ms	4 blocks		Less than 10 ms	8 blocks
50 ms	Less than 1 ms	32 blocks	50 ms	Less than 1 ms	32 blocks	50 ms	Less than 1 ms	32 blocks
	Less than 2 ms	24 blocks		Less than 2 ms	32 blocks		Less than 2 ms	32 blocks
	Less than 5 ms	12 blocks		Less than 5 ms	24 blocks		Less than 5 ms	32 blocks
	Less than 10 ms	8 blocks		Less than 10 ms	12 blocks		Less than 10 ms	24 blocks
100 ms	Less than 1 ms	32 blocks	100 ms	Less than 1 ms	32 blocks	100 ms	Less than 1 ms	32 blocks
	Less than 2 ms	32 blocks		Less than 2 ms	32 blocks		Less than 2 ms	32 blocks
	Less than 5 ms	24 blocks		Less than 5 ms	32 blocks		Less than 5 ms	32 blocks
	Less than 10 ms	12 blocks		Less than 10 ms	32 blocks		Less than 10 ms	32 blocks

## Chapter 1 Built-in FNet communication

Based on 200 words per block			Based on 100 words per block			Based on 50 words per block		
Cycle	Scan time	Blocks No.	Cycle	Scan time	Blocks No.	Cycle	Scan time	Blocks No.
200 ms	Less than 1 ms	32 blocks	200 ms	Less than 1 ms	32 blocks	200 ms	Less than 1 ms	32 blocks
	Less than 2 ms	32 blocks		Less than 2 ms	32 blocks		Less than 2 ms	32 blocks
	Less than 5 ms	32 blocks		Less than 5 ms	32 blocks		Less than 5 ms	32 blocks
	Less than 10 ms	32 blocks		Less than 10 ms	32 blocks		Less than 10 ms	32 blocks
500 ms	Less than 1 ms	32 blocks	500 ms	Less than 1 ms	32 blocks	500 ms	Less than 1 ms	32 blocks
	Less than 2 ms	32 blocks		Less than 2 ms	32 blocks		Less than 2 ms	32 blocks
	Less than 5 ms	32 blocks		Less than 5 ms	32 blocks		Less than 5 ms	32 blocks
	Less than 10 ms	32 blocks		Less than 10 ms	32 blocks		Less than 10 ms	32 blocks
1s	Less than 1 ms	32 blocks	1s	Less than 1 ms	32 blocks	1s	Less than 1 ms	32 blocks
	Less than 2 ms	32 blocks		Less than 2 ms	32 blocks		Less than 2 ms	32 blocks
	Less than 5 ms	32 blocks		Less than 5 ms	32 blocks		Less than 5 ms	32 blocks
	Less than 10 ms	32 blocks		Less than 10 ms	32 blocks		Less than 10 ms	32 blocks
5s	Less than 1 ms	32 blocks	5s	Less than 1 ms	32 blocks	5s	Less than 1 ms	32 blocks
	Less than 2 ms	32 blocks		Less than 2 ms	32 blocks		Less than 2 ms	32 blocks
	Less than 5 ms	32 blocks		Less than 5 ms	32 blocks		Less than 5 ms	32 blocks
	Less than 10 ms	32 blocks		Less than 10 ms	32 blocks		Less than 10 ms	32 blocks
10s	Less than 1 ms	32 blocks	10s	Less than 1 ms	32 blocks	10s	Less than 1 ms	32 blocks
	Less than 2 ms	32 blocks		Less than 2 ms	32 blocks		Less than 2 ms	32 blocks
	Less than 5 ms	32 blocks		Less than 5 ms	32 blocks		Less than 5 ms	32 blocks
	Less than 10 ms	32 blocks		Less than 10 ms	32 blocks		Less than 10 ms	32 blocks

※ The above values are based on using high speed link only

## 1.9 Remote communication

### 1.9.1 Outline

It is the function to realize remotely programming, user program download, program debugging, monitor, etc. in the network system where the PLCs are connected with each other through Ethernet without moving physical connection of XG5000.

For the devices that are far from the network, it is the convenient function to access to each device in one place without translocation. You can execute XG5000's remote communication service by creating the logical path as below.

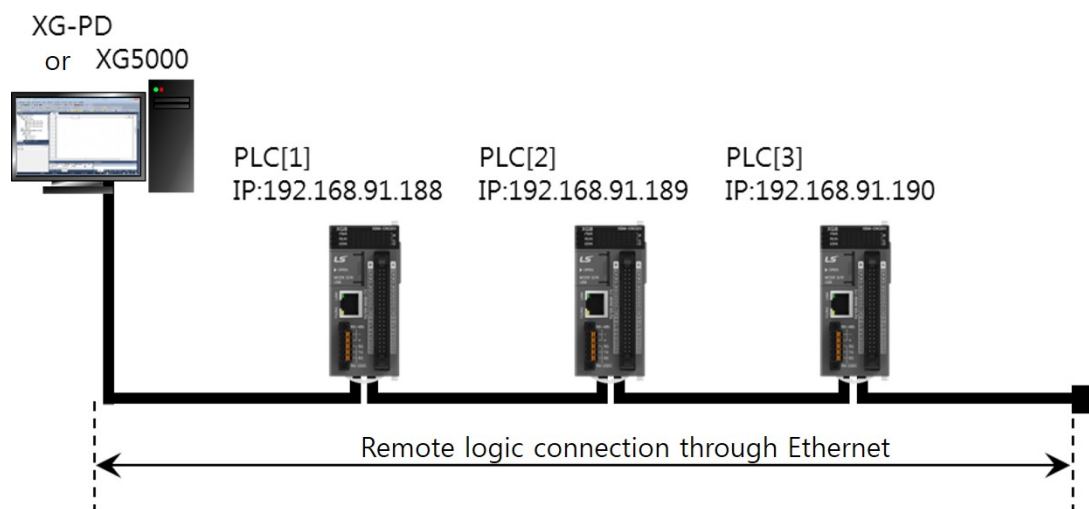

If the Ethernet module is installed in the PC where XG5000 is running and it is connected to the same network with the PLC in the above figure, you can perform the remote 1-stage access through Ethernet. Assume that the Ethernet cables are connected to the PLC #1 station in XG5000 and PLC #1, PLC #2, PLC #N are connected with each other through Ethernet.

To access the details of the PLC #N station in the above figure, set the access method as Ethernet in access setting of XG5000's online menu and input the relevant PLC #N station's IP and remote stage. In this status, you can realize all functions in the PLC #1 such as programming, download, debugging and monitor, etc.

If you use XG5000's remote communication service, you can access easily without moving to the distant PLC. In addition, although the PLC is located in the inaccessible position, it is possible to access from the other PLC so easy access can be realized after installation.

## 1.9.2 Setup and Access of XG5000

You can access all PLCs that access to the XGT network through XG5000 communication service. The XG5000 remote access is composed of 1-stage access and 2-stage access.

The below figure describes the remote 1-stage and 2-stage access methods.

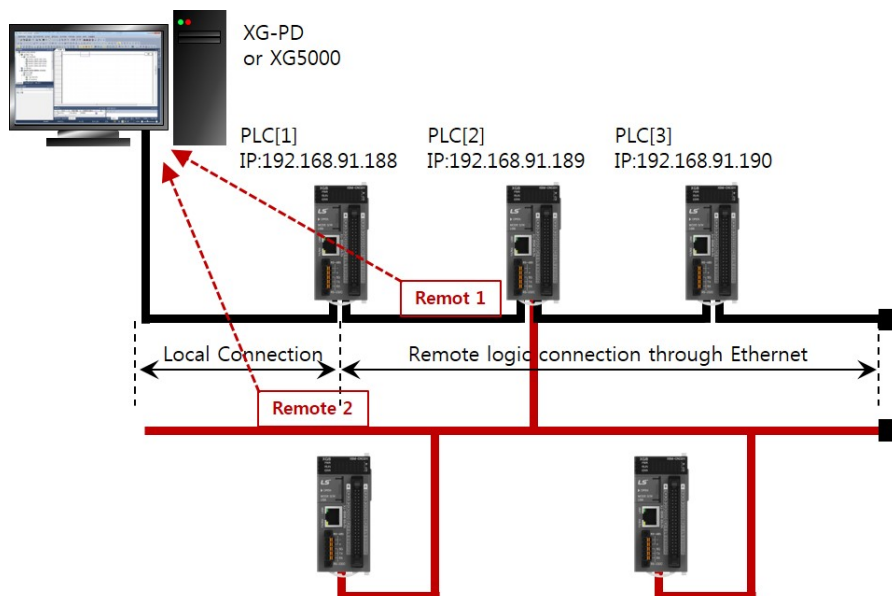

The above figure shows the example of 1-stage (PLC B) and 2-stage (PLC E) access in the system composed of two networks.

### 1) Direct and remote 1-stage access in the PC connected to Ethernet

If the PC where XG5000 is running is connected to the PLC through network, you can perform the remote 1-stage access through Ethernet without connecting RS-232C to the PLC's CPU.

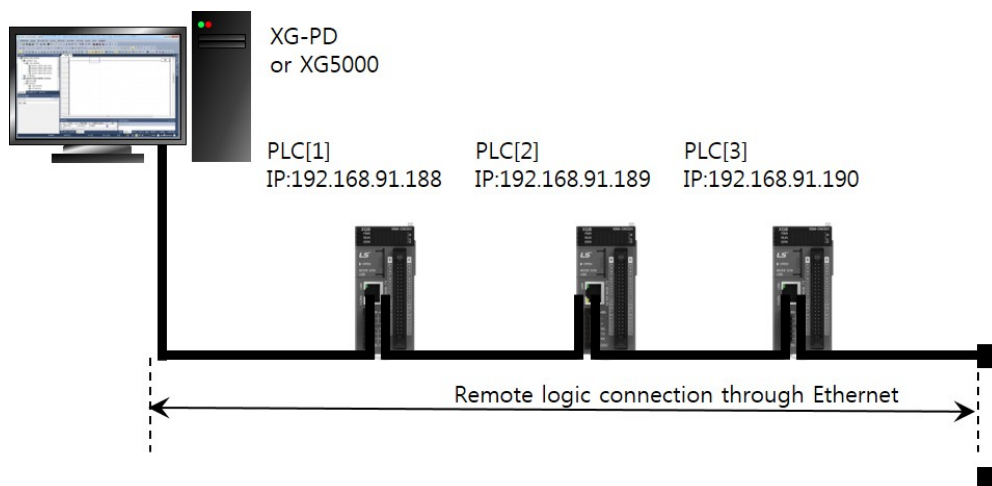

[Fig. 1.9.1] Remote 1-stage access system through the PC

[Fig. 1.9.1] shows the case that the PC and the PLC are connected through Ethernet. In this case, you can access to all PLCs in the network. The local access is omitted and the remote 1-stage access is performed for all PLCs. You need to choose the connection options and change settings as shown in the below dialog box in order to the direct and remote 1-stage access through Ethernet.

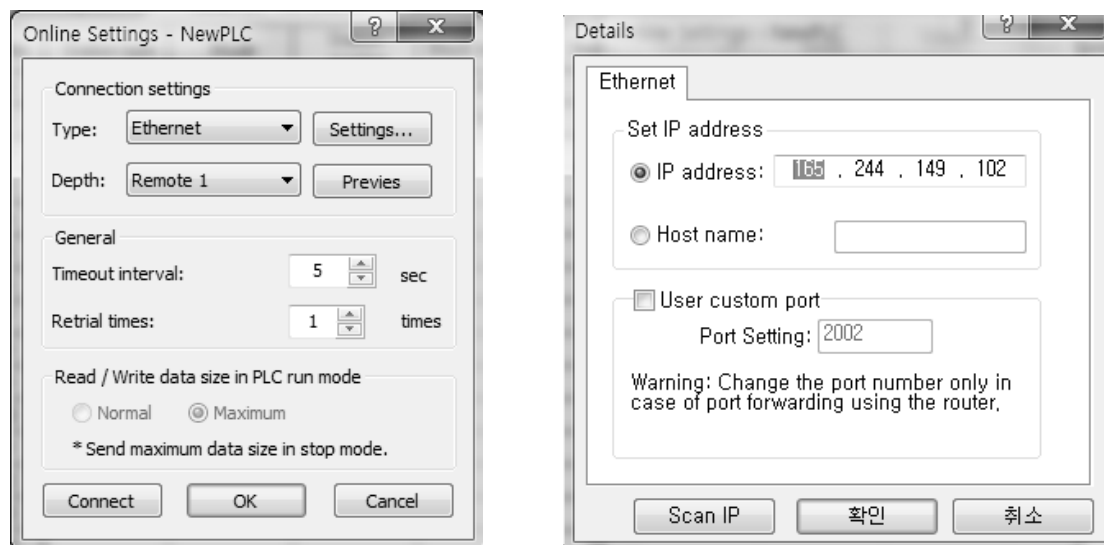

[Fig. 1.9.2] Direct and remote 1-stage access in the PC

(1) Access Method

You can select the access methods. In [Fig. 9.2.6], Ethernet is used for access instead of RS-232C so choose Ethernet.

(2) Access stage

You can determine to connect with the PLC through remote 1-stage or 2-stage. In this case, you need to choose 1-stage.

(3) IP address

Record the IP address of the FEnet I/F module to be accessed.

(4) All further processes are the same as the case using RS-232C.

Click the OK button and choose 'Access' in the online menu.

## 2) Direct and remote 2-stage access in the PC connected Ethernet

It is possible to realize the remote 2-stage access through Ethernet. The method is the same as the remote 1-stage and the example of setting access options is as below.

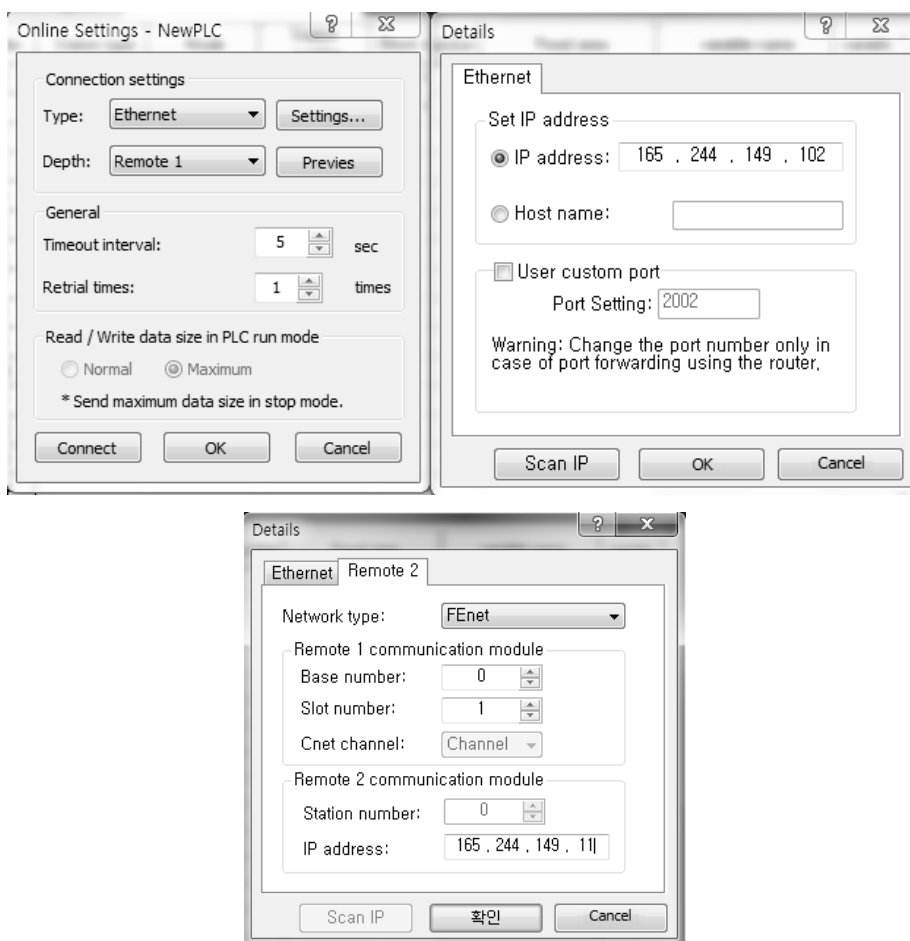

[Fig. 1.9.3] Direct and remote 2-stage access in the PC

### Notice

Instructions for remote 1-stage/2-stage access

- (1) In case the currently open project in XG5000 is not matched with the accessed 1-stage and 2-stage CPU types, the following menu items are not available.
  - a) Write program and each parameter
  - b) Read program and each parameter
  - c) Monitor
  - d) Link Enable setting
  - e) I/O information
  - f) Forced I/O information
- (2) Open the project to be accessed and execute remote access when programming XG5000 through remote 1-stage and 2-stage access.
- (3) The remote access is supported up to 2-stage only and further remote access is not allowable.
- (4) In case of writing parameters after modifying communication parameters through remote access, the modified parameters will be applied only after disconnecting remote access.

## 1.10 E-mail Transfer(SMTP)

### 1.10.1 Outline of the Simple Mail Transfer Protocol(SMTP)

XGB high-performance module PLC supports the Simple Mail Transfer Protocol (SMTP). The SMTP is the protocol to send the E-mail on the Internet. The using TCP Port is No.25. In the SMTP that is the text-based protocol, not only request/response messages but also all characters should be 7 bit ACSII.

#### 1) E-mail service

If the system has some problems, E-mail service is required to inform the administrator of the state remotely through the mail. When the CPU's state changes during operation or events occur, you can inform the administrator of the state through the mail server. The E-mail service is also available in common mails and you need to configure the separate relay server to send a common mail.

#### 2) Configuration of the E-mail system

To use the common E-mail service, the configuration for using E-mail is needed. To transfer a common mail, you need to encrypt the mail for security but it is not easy for the PLC to treat this process so that is why you have to use the SMTP relay server. The SMTP relay server accesses to the common E-mail server by using the mail information transferred by the PLC and send the mail in place of the PLC. Therefore, as shown in [Fig. 11.1.1.1] E-mail transfer process, you can send the mail through the SMTP relay server.

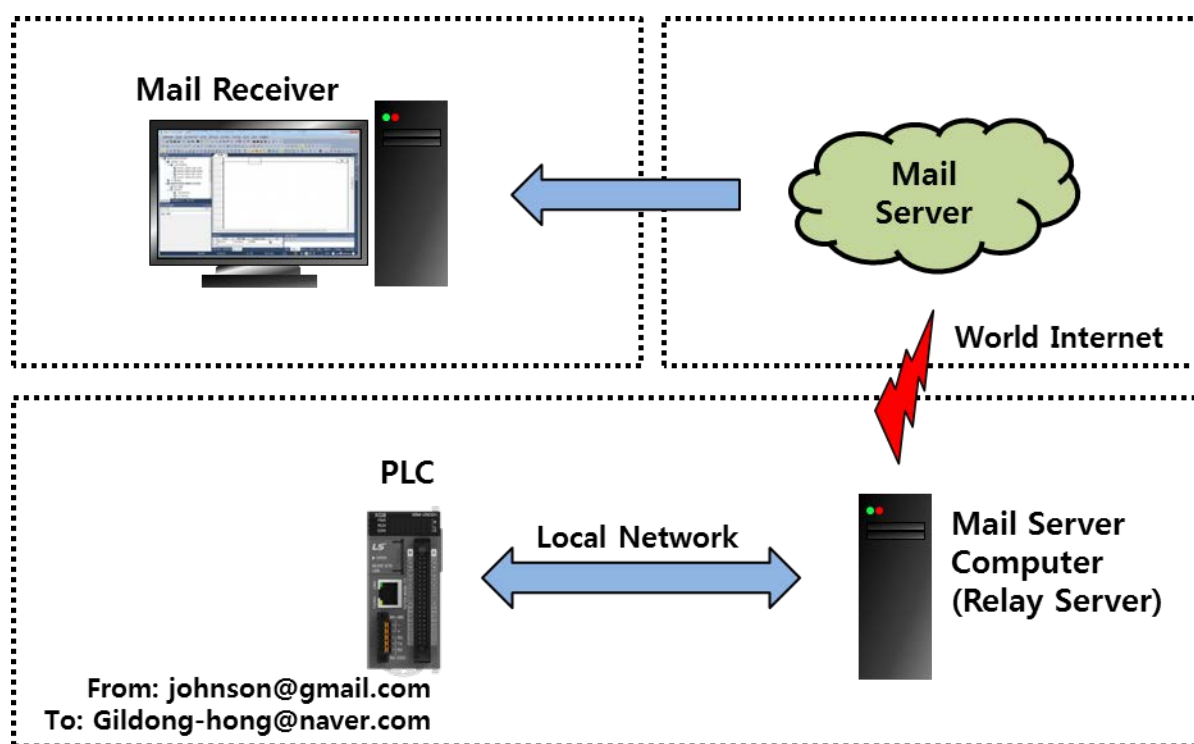

[Fig. 11.1.1.1] E-mail transfer process

#### 3) Specifications of SMTP Realy server

Items	Specifications	Remarks
Maximum concurrent connection number	8	For some email account, because it limits the mail sent through the multi-connection, some mail(occurred simultaneously by the PLC using the same account server) may not be transmitted.



#### 4) Flow Chart of E-mail transfer

The following is the flow chart of E-mail transfer. As shown in [Fig. 11.1.1.2] Flow chart of E-mail transfer, in order to transfer a mail, you need to install the SMTP relay server and set up E-mail parameters through XG5000 and meet the start-up conditions to send the mail. If the start-up conditions are met, the mail information is sent to the SMTP relay server and then, the SMTP relay server substitutingly goes through authentication process and sends the final mail to a recipient. The mail recipient can see the ID and title, details of the E-mail set in XG5000.

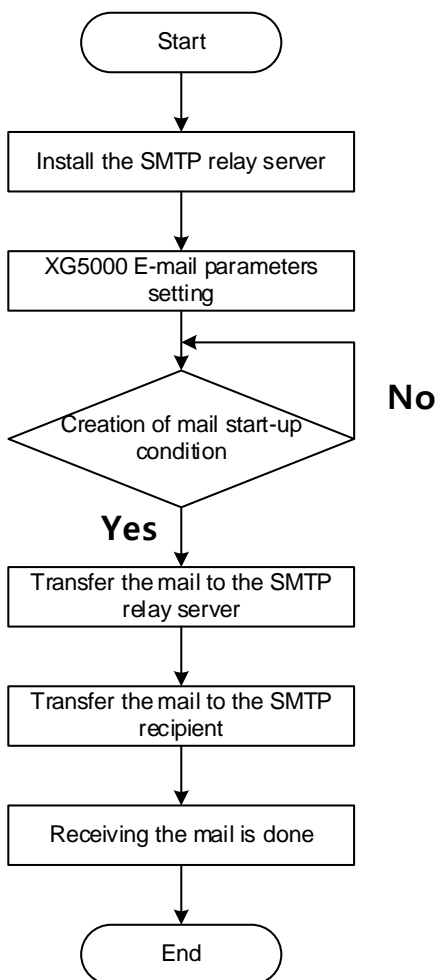

[Fig. 11.1.1.2] Flow Chart of E-mail transfer

#### Notice

- (1) The SMTP relay server and PLC should be connected to the Ethernet network. The SMTP relay server sends the mail to a recipient in place of the PLC.
- (2) For more details on setting, refer to 1.11.2 E-mail Setting.

### 1.10.2 E-mail Setting

In order to use the common E-mail function, you need to set up the E-mail parameters and relay server.

#### 1) Relay server setting



You need to set up the SMTP relay server to use the common E-mail as shown below.

#### 2) Relay server program download

In order to set up the relay server, first of all, you need to download the relay server program. You can download the relay server program from LS ELECTRIC's website – Customer Support – Download Materials (SMTP relay server).

- Korean website: <https://www.ls-electric.com/ko/download>
- English website: <https://www.ls-electric.com/support/download-center>

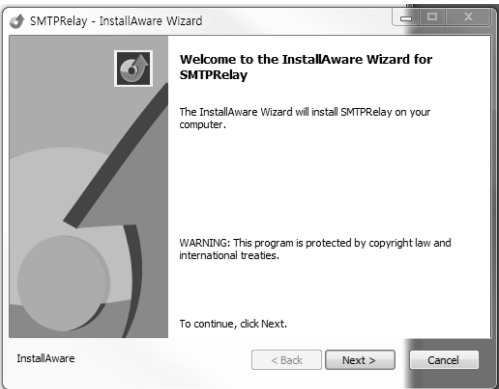
#### (1) Installaiton of the relay server

Procedures	Description	
1	Program execution	 <ol style="list-style-type: none"> <li>1) After downloading the program to set up the SMTP relay to the PC where you want to configure the relay server, double-click SMTPRelay.msi.</li> <li>2) After clicking the Next button in the SMTP Relay window, if you select the remaining processes properly and click the Finish button, installation will be done.</li> </ol>
2	SMTP relay server operations	 <ol style="list-style-type: none"> <li>1) If you double-click the 'SMTPRelayServer' icon on the desktop, the program will run as shown in the SMTP Relay server window.</li> </ol>

(2) Setting to use the relay server

After installing the relay server, you need to register the relay server program in Windows as show below.

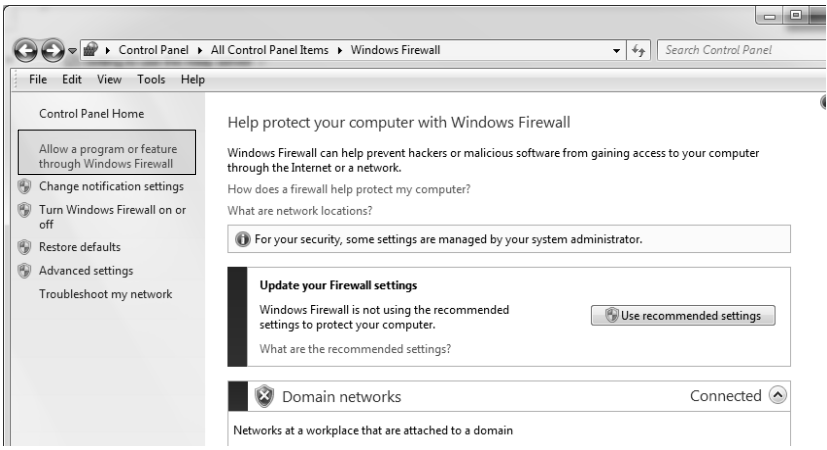
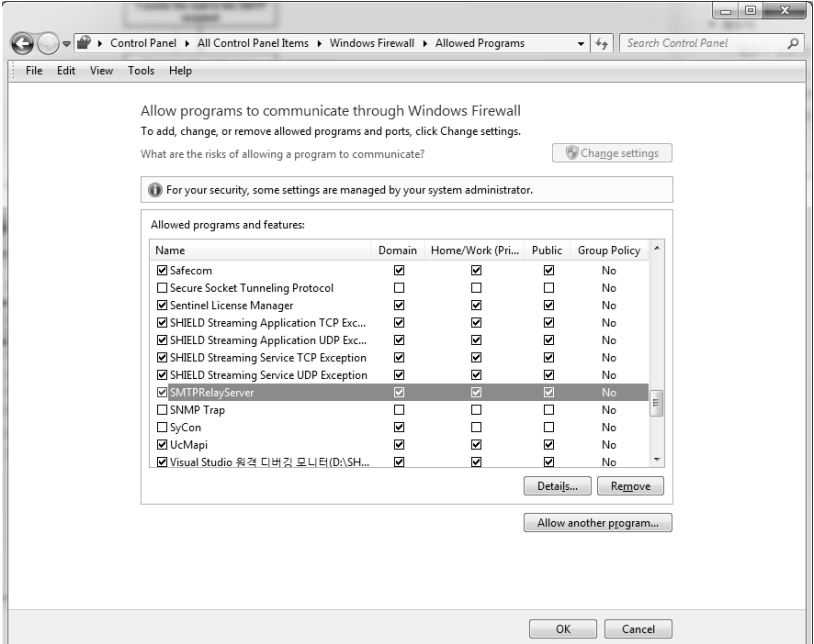
Procedures	Description	
1	Firewall setting	
<p>1) Click Windows – Control Panel – Windows firewall.                  2) Through 'Windows Firewall' in the upper-left of the Windows firewall setting screen, click the Program or Firewall Enable.</p>		
2	Firewall Enable	
<p>Find the program called 'SMTPRelayServer' and check all items of domain, home/company(individual), common areas and then, click the 'OK' button.</p>		

**Notice**

(1) After the SMTP relay server setting is completed, in the E-mail setting window of 1.11.2 E-mail Setting, you need to input the IP address of the current PC for the IP address of the SMTP relay server information.

3) E-mail setting of the P2P service

You can use the E-mail function of the P2P service as shown below.

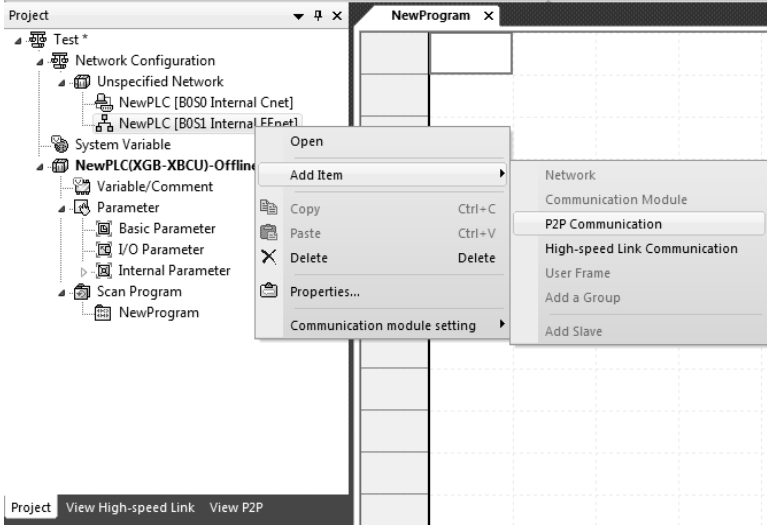
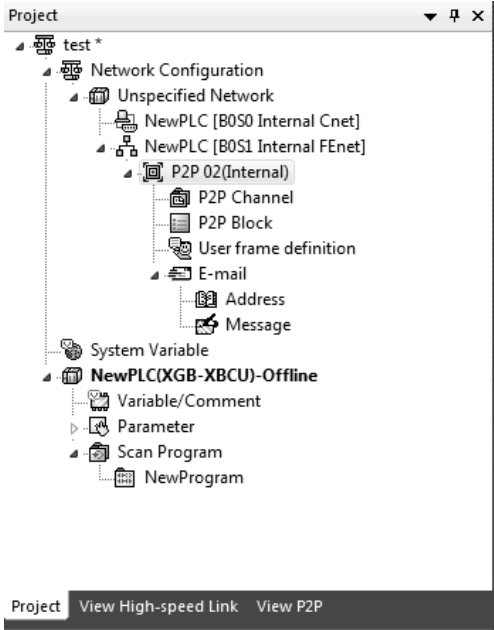
Procedures	Description	
<p>1</p> <p>Add P2P</p>		
<p>After selecting [Embedded FEnet] in XG5000's project window, click on the right mouse button and then, select [Add Items] → [P2P communication].</p>		
<p>2</p> <p>Creation of P2P</p>		
<p>When the P2P selection window is created, after selecting No.2 slot, click the 'OK' button.</p>		

**Notice**

(1) In the P2P view tab, E-mail can be set up in the same way.

Procedures	Description	
3	E-mail setting	
		<ol style="list-style-type: none"> <li>1) Double-click 'E-mail' in the P2P setting project window.</li> <li>2) Set up the values referring to each E-mail's set value.</li> <li>3) After setting parameters in the E-mail setting window, click the 'OK' button.</li> </ol>

E-mail setting values

Item	Description
Using E-mail	It determines whether using the E-mail service or now. To start the E-mail service, you need to check this item.
Using SMTP relay server	To send the mail to the common mail server, you need to check the SMTP relay server item.
User information	User name It sets up the user name displayed when the other part received the mail. If you set up the user name with the PLC, the sender name will be displayed as the PLC.
	Mail address It is the recipient's mail address when pressing 'Reply'. It indicates the transmitting mail server composed of the user name and mail server. You can also set up that the PLC sends data and a normal PC receives the reply.
SMTP relay server information	IP address When checking the SMTP relay server item, you can fill in this. Enter the IP address to relay.
	Port Number You can input the port No. of the relay server. The port is No.25.
SMTP server information	SMTP server address It means the SMTP server's address. For example, Gmail's SMTP server address is 'smtp.gmail.com'.
	Port number It means the SMTP server's port No. Gmail uses No.465.
	Account name You can input the registered account name to the SMTP server.
	Password You can input the password of the registered account to the SMTP server.

## Chapter 1 Built-in FENet communication

The below table provides the address and port No of the common SMTP server. Input the address and port No. of the desired server to the SMTP server information.

SMTP server	SMTP server address	Port No.
Google	smtp.gmail.com	465
yahoo	smtp.mail.yahoo.com	25

The event information monitors the CPU's state periodically and keeps track of the state information. In case the PLC stops or errors occur, communication parameter does not work so in preparation for such a situation, the optional service is provided.

Item		Description
Event information	Message monitoring cycle	It should be set as 10 seconds or more. It is the time to check whether the PLC's mode has been changed.
	RUN => STOP	It is the option that the embedded Ethernet sends the E-mail by itself when the PLC's mode changes from RUN into STOP.
	STOP => RUN	It is the option that the embedded Ethernet sends the E-mail by itself when the PLC's mode changes from STOP into RUN.
	ERROR	It is the option that the embedded Ethernet sends the E-mail by itself when some errors occur in the PLC.

### Notice

(1) When sending the mail through the SMTP relay server, there may be the common E-mail server that can send the mail only when the SMTP server information's 'SMTP server address' and 'account name' are matched with the user information's 'mail address'. Accordingly, check the mail server's policy and input the user information's 'mail address' based on the policy.

(2) The account name and password of the SMTP server information should be registered in the SMTP server. If you do not have any account, please register the account in the mail server for use.

(3) For more details on the address and message No. of the event information, refer to (1) Writing an address book and (3) Writing message.

(1) Writing an address book

You can write the recipient's mail address used for the E-mail service as shown below.

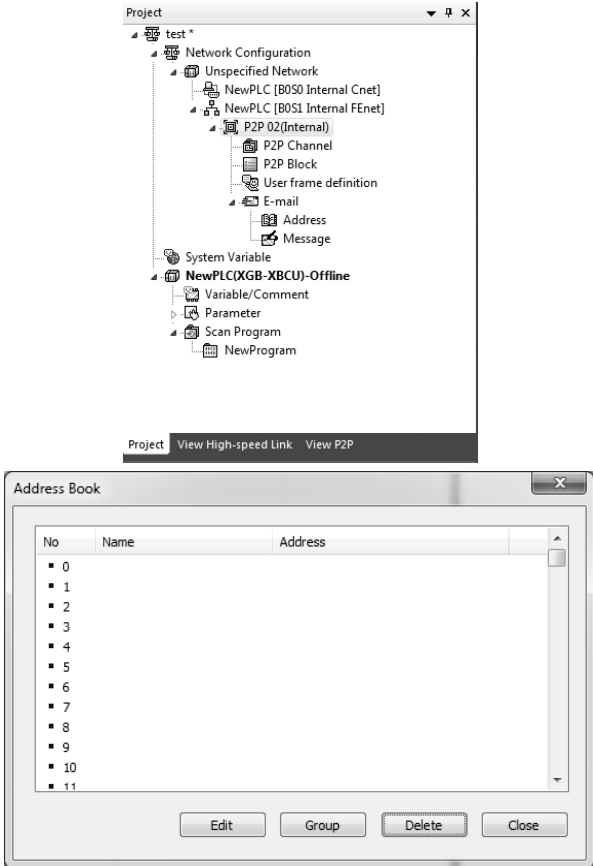
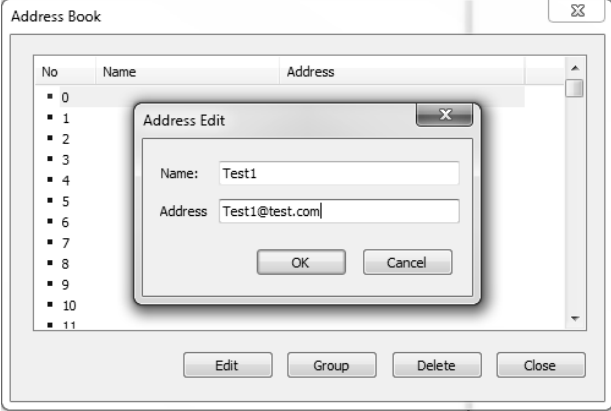
Procedures	Description	
1	Create the address book	 <p>The screenshot shows a project window with a tree view. Under 'E-mail', 'Address' is selected. Below it, the 'Address Book' dialog box is open, displaying a table with columns 'No', 'Name', and 'Address'. The table has 12 rows (0-11) and is currently empty. Buttons for 'Edit', 'Group', 'Delete', and 'Close' are at the bottom.</p>
<p>After selecting [Embedded FNet] in XG5000's project window, double-click the address of [P2P 02(embedded)] or double-click the address of P2P No.2 in [P2P View].</p>		
2	Register the address	 <p>The screenshot shows the 'Address Edit' dialog box overlaid on the 'Address Book' dialog. The 'Address Edit' dialog has two input fields: 'Name' with the value 'Test1' and 'Address' with the value 'Test1@test.com'. 'OK' and 'Cancel' buttons are at the bottom.</p>
<p>In the window for setting E-mail address book, register the address to which you want to send the mail. If you select 'Edit'. The address edition window will pop up. If you enter the name and mail address in this screen and select the OK button, registration of the address will be done.</p>		

## Chapter 1 Built-in FNet communication

### (2) Registration of group address

If you want to send the mail not to individual but to the group, you can set up the group address as shown below.

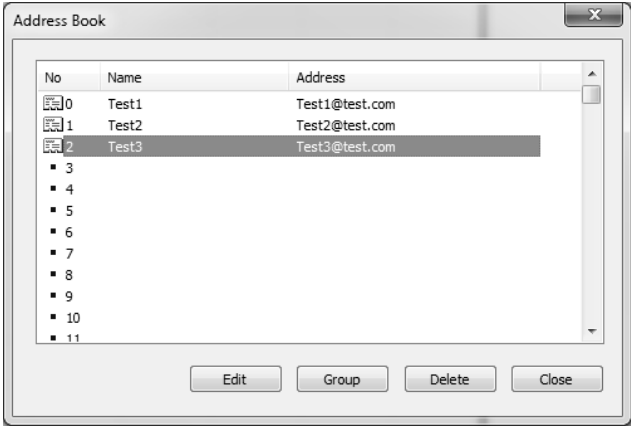
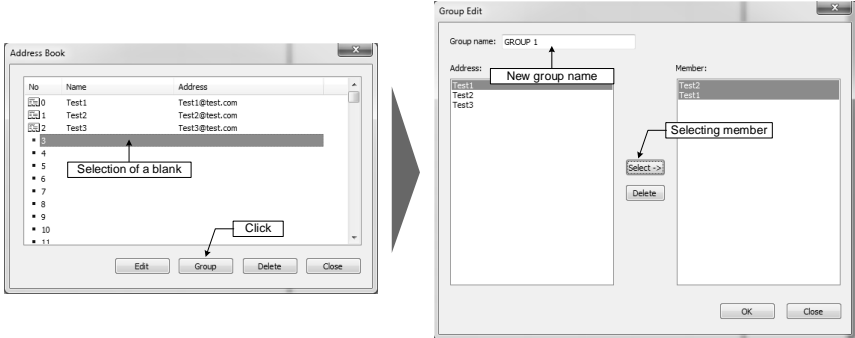
Procedures	Description	
1	Create group	 <p style="text-align: center;">&lt;Address book&gt;</p>
1) Double-click the address of P2P No.2.		
2	Register group	
<p>After selecting to a blank of [Address book], select [Address book]- [group], the edition window for E-mail address book's group will be created. The details of the group edition window are as shown below.</p> <ol style="list-style-type: none"> <li>1) Group name: Name of the group to create newly</li> <li>2) Contact information: Currently registered addresses</li> <li>3) Members: Addresses to be included to the group</li> <li>4) Select: It adds the addresses selected from the Contact Information to the Members.</li> <li>5) Delete: It deletes the addresses selected in the Members from the Group.</li> </ol> <p>After selecting the addresses to add to the group in the Contact Information, if you click [Select], you can see the addresses are added to the Members.</p>		

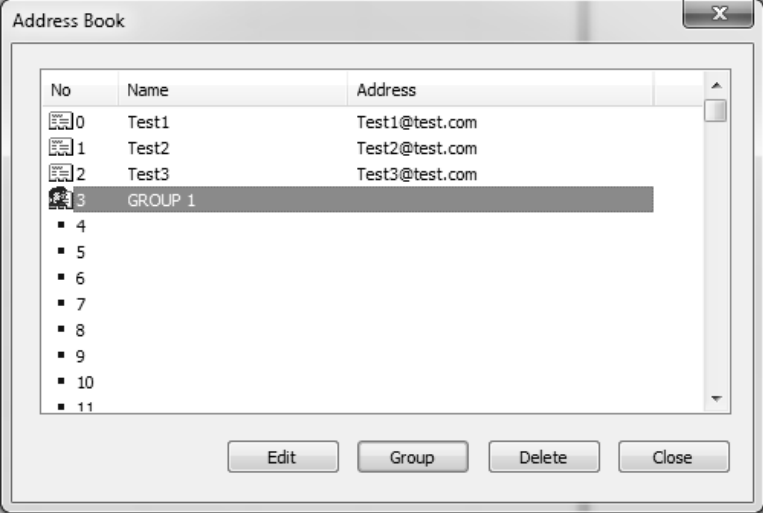

Procedures	Description	
3	Confirm creation of the group	
If you click the OK button in [Group Edition], the group list added newly to the address book will be displayed with the individual addresses.		

(3) Writing the message

You can write the mail message used for the E-mail service as shown below.

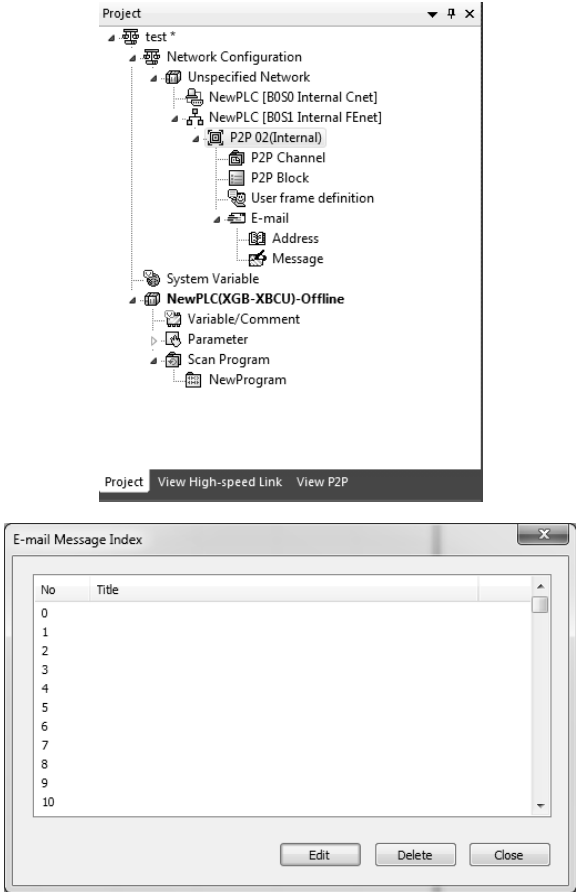
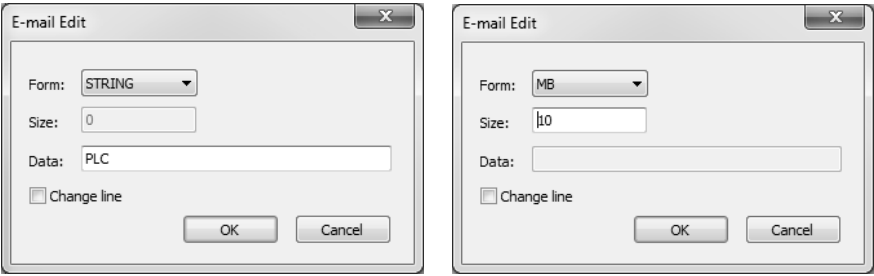
Procedures	Description	
1	Create the message list	 <p>1) After selecting [Embedded FNet] in XG5000's project window, double-click the message of [P2P 02(embedded)] or double-click the message of P2P No.2 in [P2P View].</p>
2	Write messages	 <p>Click the 'Add' button in the E-mail message editing window and input the details to send. The configuration and details of E-mail edition are as shown below.</p> <ol style="list-style-type: none"> <li>1) Format: Selection of the message type             <ul style="list-style-type: none"> <li>- STRING: Selected when the transferred message is a string type</li> <li>- MB: Selected when the transferred message is a device type</li> </ul> </li> <li>2) Size: It is activated only when the format is [MB]. It means the size of Byte.</li> <li>3) Data: It is activated only when the format is [STRING]. You can input the test to send.</li> <li>4) Line break: Means the break of a message line.</li> </ol>

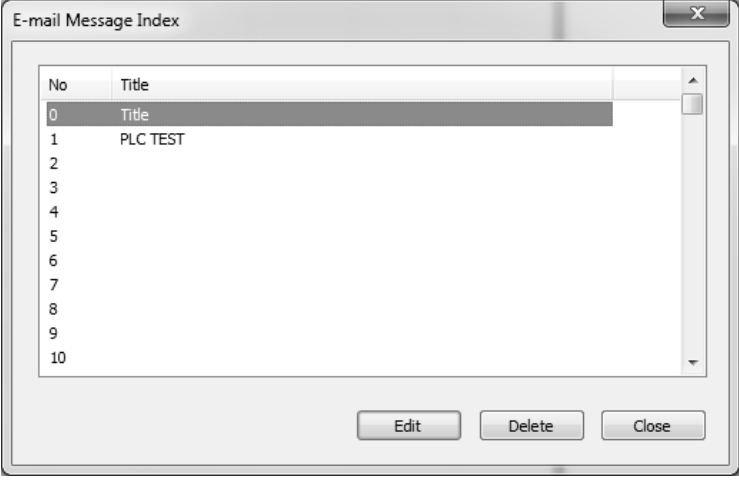
Procedures	Description	
3	Confirm creation of messages	
	When the creation of the message is complete, the title will be added to the list of e-mail messages index.	

**Notice**

- (1) The format of an E-mail message can be divided into String and Byte data received from the CPU. The MB type is used to send the P2P ESend parameter's message data as many as the number of bytes set in the Size.
- (2) The line break includes the command to write on the next line when outputting the message in the received screen.

## Chapter 1 Built-in FENet communication

### (4) P2P block setting

For the actual E-mail service, you can create the mail address book and message written above in the P2P block as shown below.

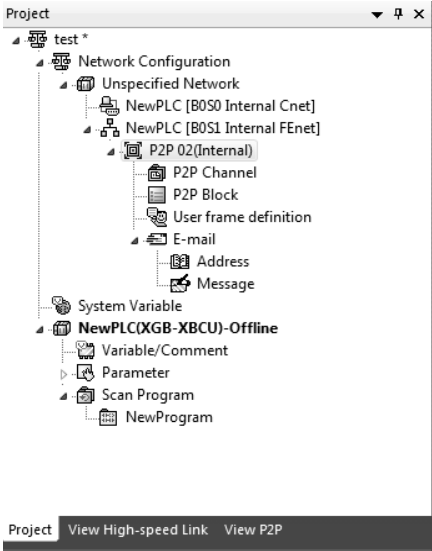
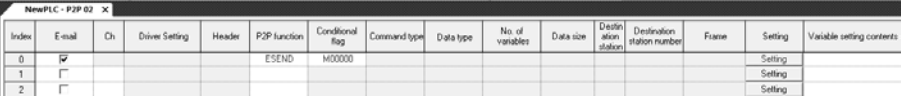
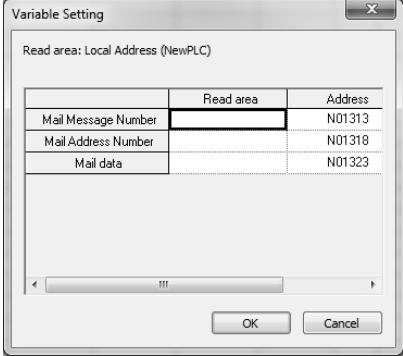
Procedures	Description	
1	P2P block	
<p>After selecting [Embedded FENet] in XG5000's project window, double-click [P2P block] of [P2P 02(embedded)] or double-click [P2P block] of P2P No.2 in [P2P View].</p>		
2	Make P2P block	
<ol style="list-style-type: none"> <li>1) In the P2P parameter setting window, tick the [E-mail] checkbox.</li> <li>2) Select [ESEND] in P2P functions.</li> <li>3) Set up the start-up conditions to transfer E-mail.</li> </ol>		
3	Setting	
<p>Click the setting button to set up each variable. For more details, refer to 'E-mail variables'</p>		
4	<p>If you click the [OK] button, the parameter settings to transfer E-mail will be done.</p>	

The details of E-mail variables are as shown below.

Item		Description	
E-mail		It enables you to use the E-mail service.	
P2P function	ESEND	It sends the E-mail.	
	ERECEIVE	It receives the E-mail.	
Setting	Transmission	Mail message No.	Enter the index No. of the message list among E-mail settings of P2P and determine the mail tile and data.
		Mail address No.	Establish the registration No. set in the address book and decide to whom. * If you want to send the mail to several people, you can set up grouping. In this case, the <b>recipient's</b> mail address should be input in advance before grouping. The maximum number of groupings is limited to 10EA or less.
		Mail data	It means the start address of the data to send. In terms of the size of the transmitted data, starting with the first part, the mail is transmitted as many as the number of arrays corresponding to MB[10] among E-mail message settings.
	Reception	Mail information	It is the area where the mail information is saved.
		Mail message	It saves the received mail message to the PLC memory.

**Notice**

(1) The receiving pare is not supported in settings.

(5) Writing parameters

After parameter setting for the E-mail service is completed, you can apply the parameters to the PLC as show below.

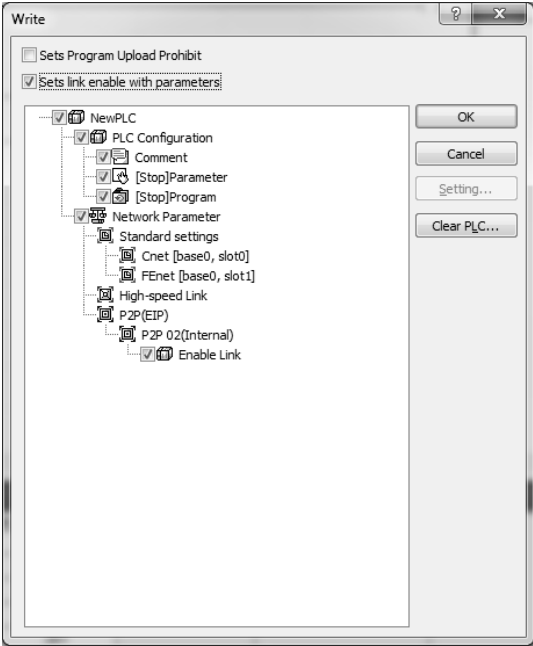
Procedures	Description	
1	Write parameters and Link Enable	
	Select [Online] → [Write] in XG5000's project window. After checking [Set together with Link Enable] in the [Write] window, check 'Link Enable' in P2P 02(embedded).	
2	If you click the [OK] button, 'Write Parameters' and 'Link Enable' will be done.	

**Notice**

- (1) If you set up the parameters for the SMTP relay server to use common E-mails (Gmail, yahoo, etc.), you need to set up for SMTP relay server.
  - Refer to (2) Setting to use the relay server of 1.11.2 E-mail Setting



## 1.11 Time synchronization(SNTP)

### 1.11.1 Outline of the time synchronization protocol

The XGB high-performance PLC supports the NTP(Network Time Protocol) that obtains the time information by accessing to the SNTP(Simple Network Time Protocol)server and synchronizes time. The NTP is the protocol to synchronize the time of the PLC connected to the network.

### 1.11.2 SNTP server parameter setting

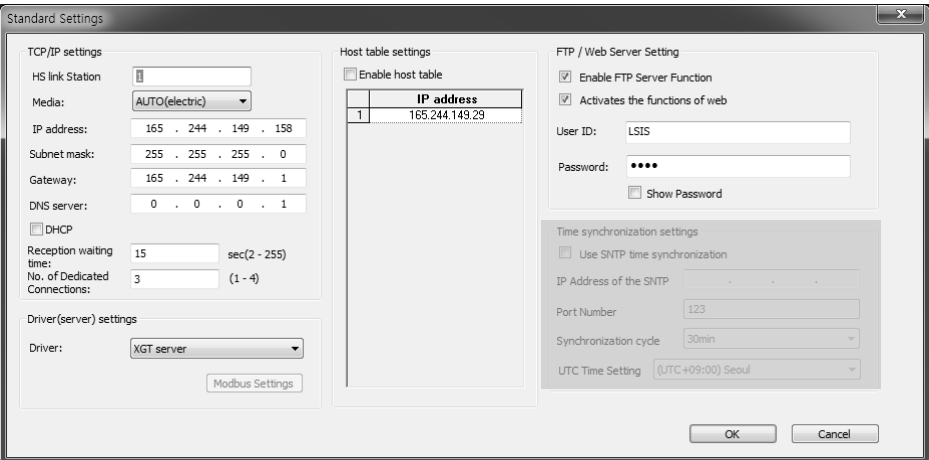
You can set up the parameters to use the SNTP server function as shown below.

Procedures	Description	
1	Setting for SNTP	
2	Write parameters and Link Enable	
	<p>1) Input the [TCP/IP setting] parameters in the FEnet basic setting window.                  - Enter the IP address, subnet mask, gateway, DNS server address.                  - This address is commonly used for P2P service, high speed link service, remote service, FTP, SNTP service, etc.</p> <p>2) Check [SNTP Time Synchronization Enable].</p> <p>3) Then, set up the SNTP server's IP address and Port No., synchronization cycle, UTC time setting.</p>	
3	<p>If you click the [OK] button, 'Write Parameters' will be done.</p>	

**Notice**

- (1) When parameter setting is done, the PLC reads periodically the time value from the SNTP server.
- (2) In the SNTP server's IP address, the initial '203.248.240.140' port is set as '123'.  
This is the open SNTP server called 'Time.bora.net'.
- (3) If you want to use other SMTP servers, change the IP address and port No. of the SNTP server before input. Below is an example of public NTP server and port..

Server address	IP	Port	Support
time.apple.com	17.253.6.243	123	Apple
time.asia.apple.com	17.83.253.7	123	Apple
time.euro.apple.com	17.72.148.52	123	Apple
ntp.komet.net	168.126.3.6	123	KT(Korea)
time.kriss.re.kr	210.98.16.100	123	KRISS(Korea)
time.nuri.net	211.115.194.21	123	inethosting(Korea)
time.nist.gov	132.163.4.102	123	NIST(Korea)
time.windows.com	191.233.81.105	123	MS
1.kr.pool.ntp.org	211.233.40.78	123	Navyism(Korea)
1.asia.pool.ntp.org	125.62.193.121	123	Navyism(Korea)
2.asia.pool.ntp.org	82.200.209.236	123	Navyism(Korea)
3.asia.pool.ntp.org	218.189.210.4	123	Navyism(Korea)

- (4) If you cannot use a public NTP server, Please setup a local NTP server refer to '**1.12.3 How to setup a local NTP server**'.



### 1.11.3 How to setup a local NTP server

If you cannot use a public NTP server, Please setup a local NTP server as follows:

- 1) Select the [Start] button of Windows for execution.(Shortcut key /Windows key + R)
- 2) Input 'regedit' to the execution window and run the process.

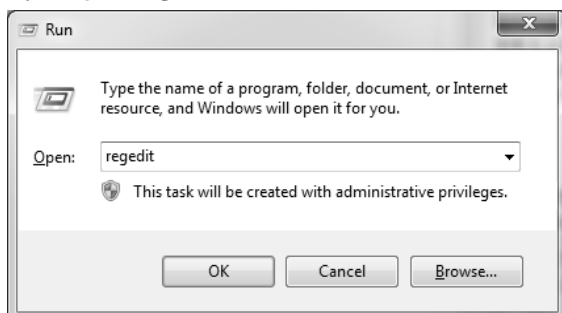

- 3) Check the below path.  
**HKEY\_LOCAL\_MACHINE\SYSTEM\CurrentControlSet\Services\W32Time\TimeProviders\NtpServer**
- 4) Change the value of 'Enabled' to '1' in the folder.

 Enabled	REG_DWORD	0x00000001 (1)
--	-----------	----------------

- 5) Check the below path.  
**HKEY\_LOCAL\_MACHINE\SYSTEM\CurrentControlSet\Services\W32Time\Config**
- 6) Change the value of 'AnnounceFlags' to '5' in the folder.

 AnnounceFlags	REG_DWORD	0x00000005 (5)
---	-----------	----------------

## Chapter 1 Built-in FNet communication

- 7) Reboot the computer.
- 8) Setup inbound firewall rules.
  - (1) Run the Control Panel.
  - (2) Run the Window Firewall
  - (3) When you run the Advanced Settings screen will pop up as shown below.

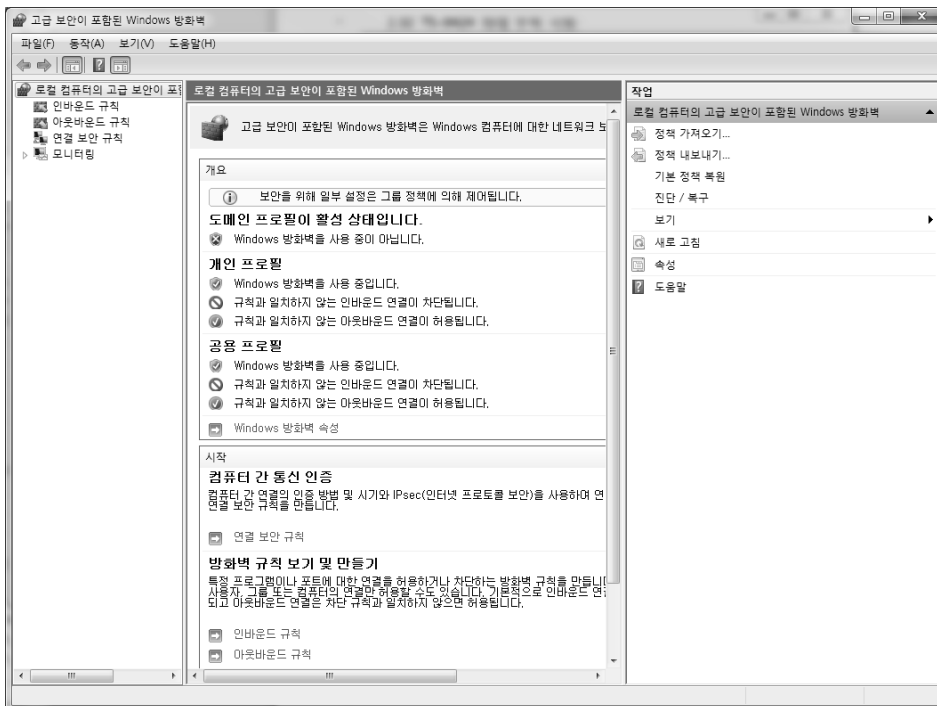

- (4) Select inbound rules.

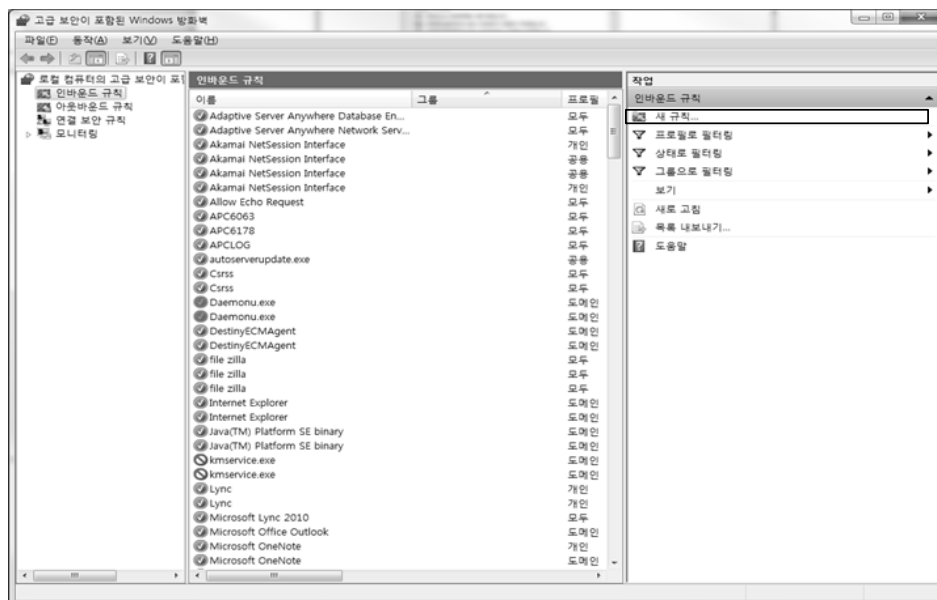

(5) Select the new rule in the top right.



(6) Select the port and click Next button.

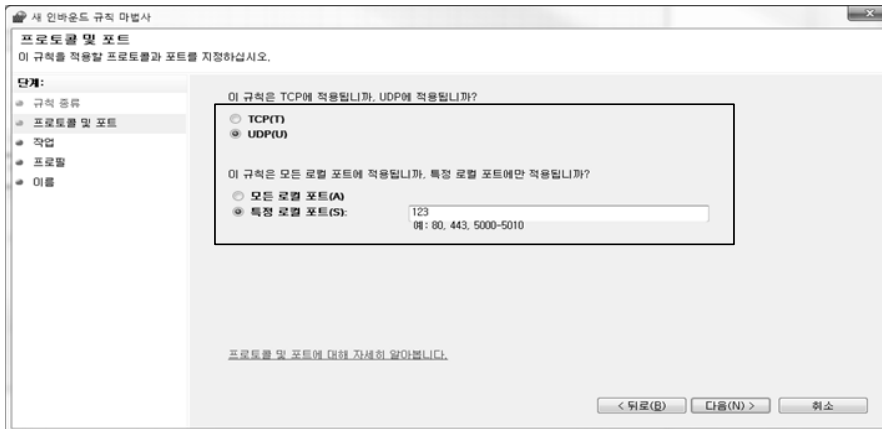

(7) Select **UDP(U)** and **Special local port(S)**. Input '123' and click Next button.

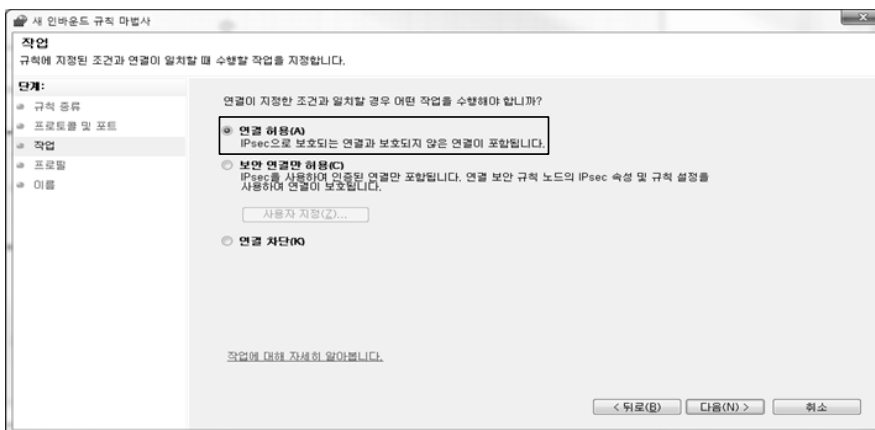

(8) Select **Allow connections(A)** and click Next button.



(9) Please select the checkbox to meet your security policy, and click Next button.



(10) Input the server name(anything) and description and click Finish button.

- 9) Select the [Start] button of Windows for execution(Shortcut Key /Windowskey + R)
- 10) Enter '**CMD**' and click Confirm.(Administrator)
- 11) In the command window, Input '**net stop w32time**'and press Enter key. And then, also input '**net start w32time**'and press Enter key.
- 12) Input '**ipconfig**' and press Enter key in the command window to find out the IP address of NTP server.
- 13) Setting the parameters using IP address of NTP server.(refer to '**1.12.2 SNTP server parameter setting**')

## 1.12 Trouble Shooting

It describes errors that may occur during system operation and provides the causes of errors, corrective measures. You can check whether there are some problems with the XGB embedded Fenet and the details through the below procedures. Please note that we do not provide after-sales service for discretionary repair or disassembly based on the Quality Policy.

Problem	Corrective Measures
In case LINK/ACT LED flickers or is not turned on after connecting to network.	<ol style="list-style-type: none"> <li>1. Check whether the cables clicked inserted.</li> <li>2. Check whether the XG-PD parameters are already downloaded.                             <ul style="list-style-type: none"> <li>☞ In case XG-PD's communication basic parameters are not downloaded, you cannot set up Full Duplex /Half Duplex communication.</li> </ul> </li> </ol>
In case the LINK/ACT, SPEED LED are still turned Off, although you download parameters after supplying power and connecting network	Module defect is suspected so follow-up service may be required.
In case Read/Write Data do not work during dedicated services	<ol style="list-style-type: none"> <li>1. Check the communication speed(Auto/10/100M-TX) . It should have the same communication speed with the opposing device to be communicated.                             <ul style="list-style-type: none"> <li>☞ In case the device with Auto Negotiation and the device with manual speed are mixed in the network, the former recognizes the latter as Half Duplex(standard specification of IEC 802.3u)</li> </ul> </li> <li>2. Check the IP address settings. The IP should be valid in the network.                             <ul style="list-style-type: none"> <li>☞ In case the set IP addresses are overlapped in the network or invalid IP exists, communication is impossible.</li> </ul> </li> <li>3. Check the driver(dedicated, Modbus TCP/IP) settings.                             <ul style="list-style-type: none"> <li>☞ You should apply the same protocols with the opposing device.</li> </ul> </li> <li>4. Check whether the opposing device's IP is registered in the host table.                             <ul style="list-style-type: none"> <li>☞ When the opposing device's IP address is not registered under host table Enable, communication does not work.</li> </ul> </li> <li>5. Check the MAC Address                             <ul style="list-style-type: none"> <li>☞ In case the MAC Address is abnormal, communication does not work.</li> </ul> </li> </ol>

Problem	Corrective Measures
In case transmission -reception is impossible during high speed link service	1. Check the communication speed(Auto/10/100M-TX). It should have the same communication speed with the opposing device to be communicated. <ul style="list-style-type: none"><li>☞ The communication speed in the network should be same or set as Auto for communication.</li></ul>
	2. Check the IP address settings. The IP should be valid in the network. <ul style="list-style-type: none"><li>☞ In case the set IP addresses are overlapped in the network or invalid IP exists, communication is impossible.</li></ul>
	3. Check whether the high speed link's parameters are set. <ul style="list-style-type: none"><li>☞ In case the parameters are not set; or the set exchange numbers are overlapped in the network; or you have wrong block setting or block number, communication is impossible.</li></ul>
	4. Check the Link Enable <ul style="list-style-type: none"><li>☞ The frame can be transmitted only when the Link Enable is set.</li></ul>



## Chapter 2 Built-in Cnet Communication

### 2.1 General

Ultimate performance XBM Main Unit has built-in RS-232C 1 channel and RS-485 1 channel.

#### 2.1.1 Characteristic

Main characteristic of built-in Cnet is as shown below.

- (1) By using XG5000 operated in window environment, since the user can write communication speed, communication mode (protocol), connection with external device is easy.
- (2) RS-232C 1 port, RS-485 1 port as main unit built-in Cnet is supported.
- (3) It operates independently according to channel. Since protocol data written by user is managed by main unit, in case communication module is changed, additional setting/download is not necessary.
- (4) Device read/write by using XGT dedicated/modbus/user defined protocol is available.
- (5) It provides communication function in which multidrop, up to 32 connection is available in case of using RS-485.
- (6) Setting of diverse communication speed is available. (1200,2400,4800,9600,19200,38400,57600,115200bps)
- (7) 1:1 and 1:N communication are available.
- (8) With abundant self-diagnosis, trouble diagnosis is simple.
- (9) It supports dedicated server/client, modbus server/client, user defined communication function.



## 2.2 Specification

### 2.2.1 Performance Specification

Item		Specification	
		Channel 1	Channel 2
Serial communication method		RS-232C	RS-485
Modem connection function		-	-
Operation mode (Operation define by channel)	P2P	Act as communication client - XGT dedicated protocol client - Modbus ASCII/RTU client - User defined communication - LS Bus Client <sup>Notes 1)</sup>	
	Server	- XGT dedicated protocol server - Modbus ASCII/RTU server	
Data type	Data bit	7 or 8	
	Stop bit	1 or 2	
	Parity	Even/Odd/None	
Synchronization type		Asynchronous type	
Transmission speed (bps)		1200/2400/4800/9600/19200/38400/57600/115200 bps available	
Station No. setting		Setting range: 0~255 Max. station No. available: 32 stations	
Transmission distance		Max. 15m	Max. 500m
Diagnosis function		Check available by XG-PD diagnosis service	

#### Notes

When consisting Client and server, max. 32 stations is possible. Station No. can be set up 0 to 255.

2.2.2 Name and Function of Built-in Cnet Part

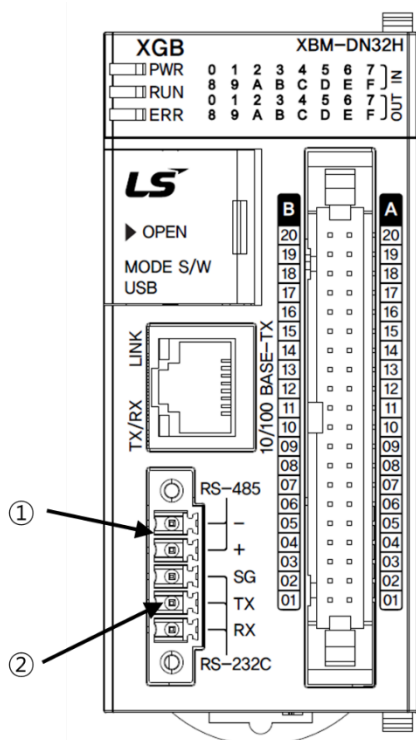

No.	Item	Description
①	RS-485 connection terminal	Built-in RS-485 connection connector
②	RS-232C connection terminal	Built-in RS-232C connection connector

Pin No.	Name	Description	Signal direction (XGBU ↔ External Device)	Function Description
1	485-	485 – Signal	←→	Built-in RS-485- Signal
2	485+	485 + Signal	←→	Built-in RS-485+ Signal
3	SG	Signal Ground	—	Signal ground
4	TX	Transmitted Data	→	Built-in RS-232C transmitted data signal
5	RX	Received Data	←	Built-in RS-232C received data signal

## 1) Wiring method when using built-in RS-232C

When connecting in null modem mode, connect 3-wire system as follow.

Cnet(9-PIN)		Connection number and signal direction	Computer/ communication device
Pin No.	Name		Name
3	SG	→	SG
4	TX	←	TXD
5	RX	→	RXD

## 2) Wiring method when using built-in RS-485

Pin No.	Name	Signal direction	External communication device
1	485-	←→	485-
2	485+	←→	485+

### 2.2.3 Cable Specifications

When using communication channel, RS-485, twisted pair cable for RS-422 shall be used in consideration of communication distance and speed. RS-485.

[Table 2.2.1] describes recommended specifications of cable. Also when using other cable than recommended, the cable conforming to characteristics in [Table 2.2.1] shall be used.

- Product : Low Capacitance LAN Interface Cable
- Type : LIREV-AMESB
- Size : 2P X 22AWG(D/0.254 TA)
- Manufacturer: LS Cable

#### 1) Cable specification

##### (1) Electrical characteristic

Item	Standard	Test conditions
Withstanding voltage	No destruction	500V/1min
Insulation resistance	1,000 MΩ.km or above	20 °C
Static electricity capacity	45 pF/M or less	1 kHz
Characteristics impedance	120 ± 5 Ω	10 MHz

##### (2) External characteristic

Item	Unit	Standard
Conductor	Cores	Pair
	Size	AWG
	Composition	No./mm
	Outer dia.	mm
Insulator	Thickness	mm
	Outer dia.	mm

[Table 2.2.1] Cnet twisted pair cable specification

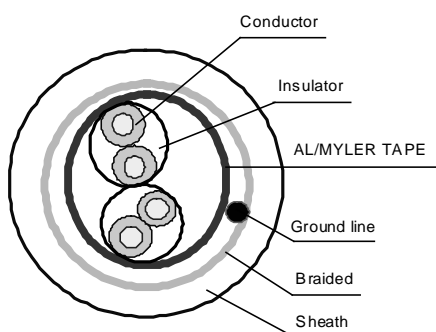

[Figure 2.2.1] Structure

## 2.2.4 Channel Operation of Built-in Communication

In case of built-in Cnet of XBCU, each communication port operates independently to allow simultaneous Tx/Rx in separate transmission specifications. Transmission specifications can be set per RS-232C and RS-485 channel, and the operation is started and stopped according to channels. Data flow of each channel is as below.

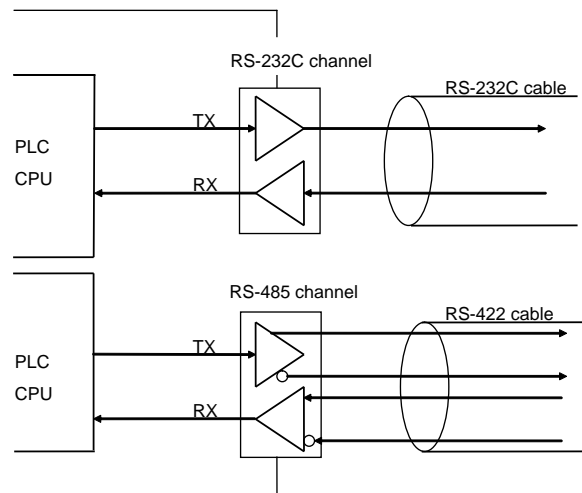

### Note

- (1) For mode change during RUN, download parameter by using XG5000.
- (2) Though you don't reset the PLC, if download is complete, changed mode is applied.

## 2.2.5 Termination Resistor

For communication via XBCU PLC built-in RS-485 channel, termination resistor from external must be connected.

Termination resistor has the function to prevent distortion of signal by reflected wave of cable for long-distance communication, and the same resistance ( $1/2W$ ) as characteristic impedance of cable must be connected to terminal of network.

When using the recommended cable in 2.2.3 connect termination resistor of  $120\Omega$  to both ends of cable. Also when using other cable than recommended, the same resistance ( $1/2W$ ) as characteristic impedance of cable must be connected to both ends of cable

- Recommended termination resistor:  $1/2W$ ,  $120\Omega$ , 5% tolerance

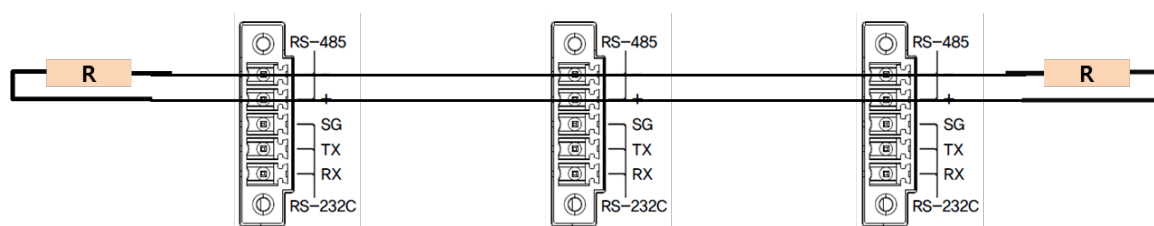

[Termination resistor connection diagram for RS-485 ]

## 2.3 Cnet Communication System Configuration

Communication system by using XGB built-in communication function is diverse. In this chapter, it describes system configuration example.

### 2.3.1 1:1 Connection to PC (HMI) (No Modem)

PC (HMI) and XBCU main unit are connected by RS-232C or RS-485 channel, PC (HMI) and PLC is connected by 1:1 without modem. In most case, PC (HMI) acts as client and Cnet I/F module acts as server which respond request of PC (HMI). Since there is no modem, in case of using RS-232C channel, communication distance is max 15m, in case of using RS-422 channel, communication distance is max 500m. Operation mode of Cnet I/F is set according to PC (HMI)'s communication method.

1) In case of using 1:1 connection with normal PC

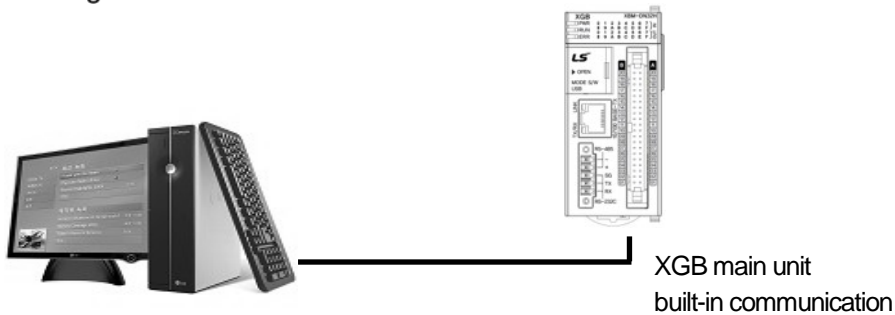

• Wiring method

External form of PC	PC	Connection number and signal direction	XGB main unit		XGB external form
	Pin no.		Pin no.	Signal name	
<p>Female Type</p>	1		1	485-	
	2 (RXD)		2	485+	
	3(TXD)		3	SG	
	4		4	TX	
	5(GND)		5	RX	
	6				
	7				
	8				
	9				

In case of using channel 2, connect 485+ and 485- of RS485 terminal.

2) In case of using 1:1 connection with monitoring device such as XGT Panel



• Wiring method (RS-232C)

XP external form	XP	Connection number and signal direction	XGB main unit		XGB external form
	Pin No.		Pin No.	Signal Name	
<p>Female Type</p>	1		1	485-	
	2(RXD)		2	485+	
	3(TXD)		3	SG	
	4		4	TX	
	5(GND)		5	RX	
	6				
	7				
	8				
	9				

Note) In case of PMU, short no.4 and no.6, short no.7 and no.8.

• Wiring method (RS-485)

PMU	Connection no. and signal direction	XGB main unit
485+	←→	485+
485-	←→	485-



3) In case of using 1:1 connection with XGB main unit

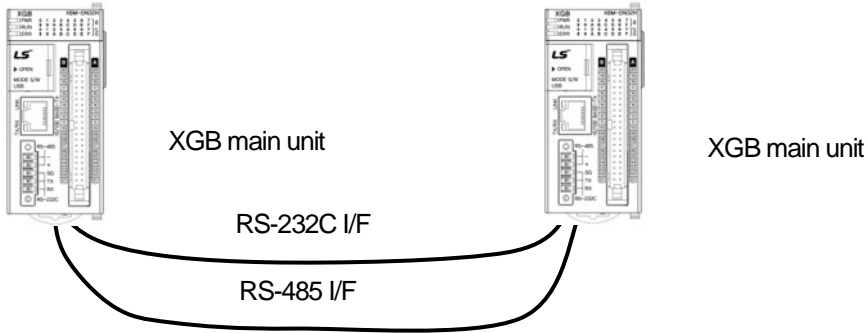

• Wiring method

XGB external form	XGB main unit	Connection no. and signal direction	XGB main unit	
	Pin No.		Pin No.	Signal name
<p>RS-485 SG TX RX RS-232C</p>	1	↔	1	485-
	2	↔	2	485+
	3	—	3	SG
	4	↔	4	TX
	5	↔	5	RX

### 2.3.2 Dedicated Modem Connection with PC(HMI)

It is 1:1 communication system connected through dedicated modem through RS-232C channel with PC (HMI). Normally, PC (HMI) acts as client station, Cnet I/F module acts as server station which respond request of PC (HMI). Since it uses modem, RS-232C channel should be set as dedicated modem and long distance communication is available. Operation mode of this module should be set according to communication method of PC (HMI).

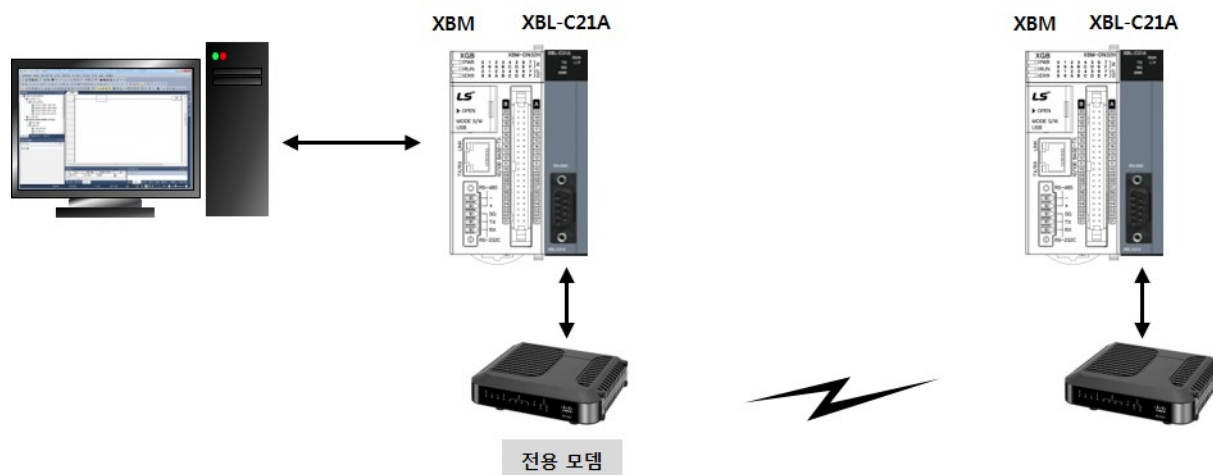

### 2.3.3 Modem Connection with PC and Communication between Cnet I/F Modules

- PC and Cnet #1 station is connected by modem through RS-232C channel
- Cnet #1 station ~ N station is communication between Cnet I/F module through RS-422 channel
- Cnet #1 station ~ N station is Communication between Cnet I/F modules through RS-422 channel
- PC acts as client station of Cnet #1 station
- Up to max 32 station connection is available in case of Cnet I/F module (RS-422/485 communication)
- It sets station 1 among Cnet I/F module as server station
- Dedicate modem or dial-up modem available

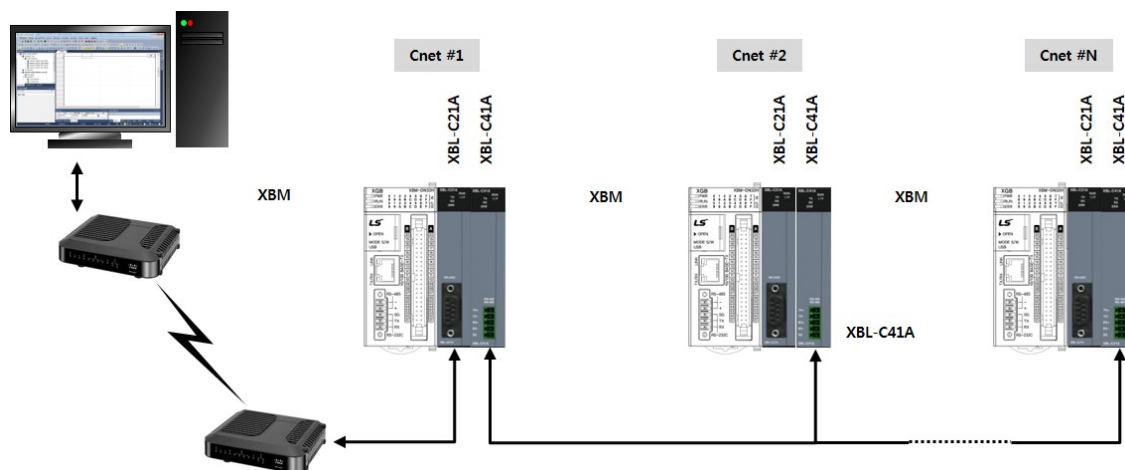

Type	Module setting	
	XBL-C41A	Station no.
PLC Cnet #1	P2P	1
	XGT client	
Cnet #2 ~ #N	XGT server	2~N

### 2.3.4 Dedicated Communication with PC(HMI) and Different type RS-422 Communication

- Null-modem communication by using PC (HMI) and RS-232C channel
- PC (HMI) acts as client station, Cnet I/F module acts as server, at this time, module setting acts as RS-232C XGT server
- Cnet I/F module RS-422 channel acts as P2P mode.
- It transmits indication data to display module of mosaic panel through RS-422 channel
- Reading display transmission data from PC

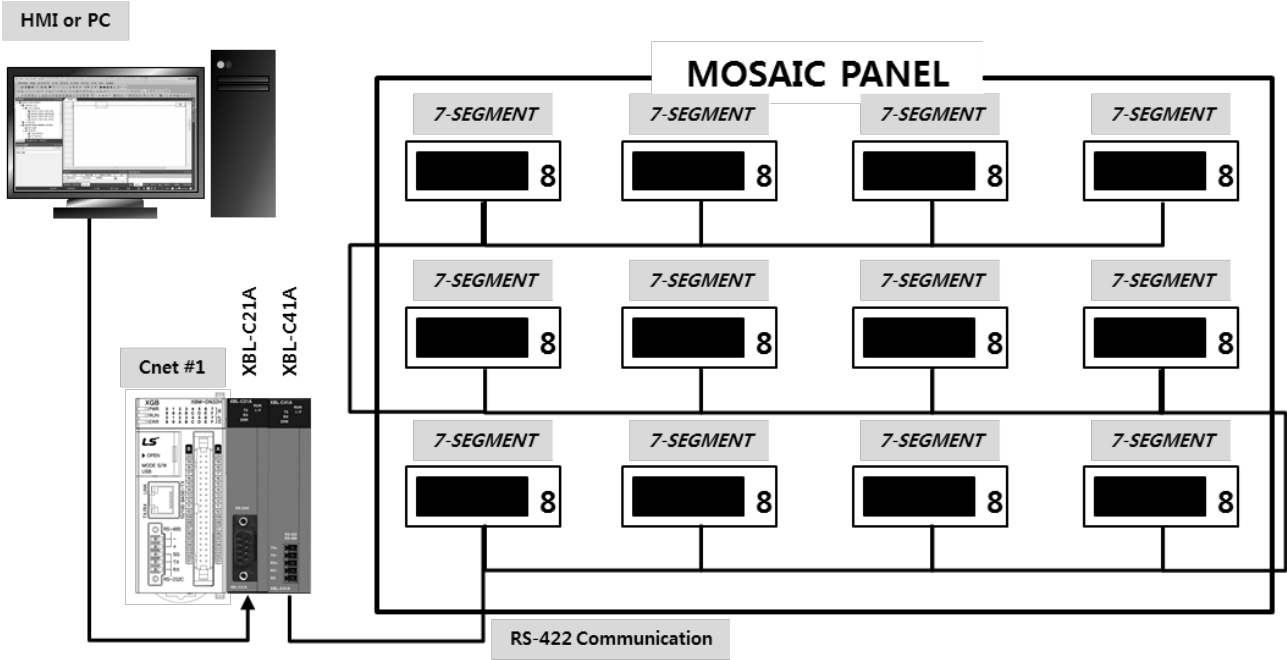

Type	Module setting		
	XBL-C21A	XBL-C41A	Station no.
PLC Cnet #1	XGT server	P2P	1

### 2.3.5 Optical Modem Communication for Moving Material Communication

- Optical modem communication system for Cnet communication on material above moving linearly
- P2P communication or dedicated mode communication with monitoring device
- RS-232C/RS-422 communication with optical modem
- Communication between Cnet I/F module is dedicated server/client communication
- Optical modem connected with Cnet I/F module on mobile body can communicate with the other optical modem only when positioned in communication available
- Main application: Parking tower

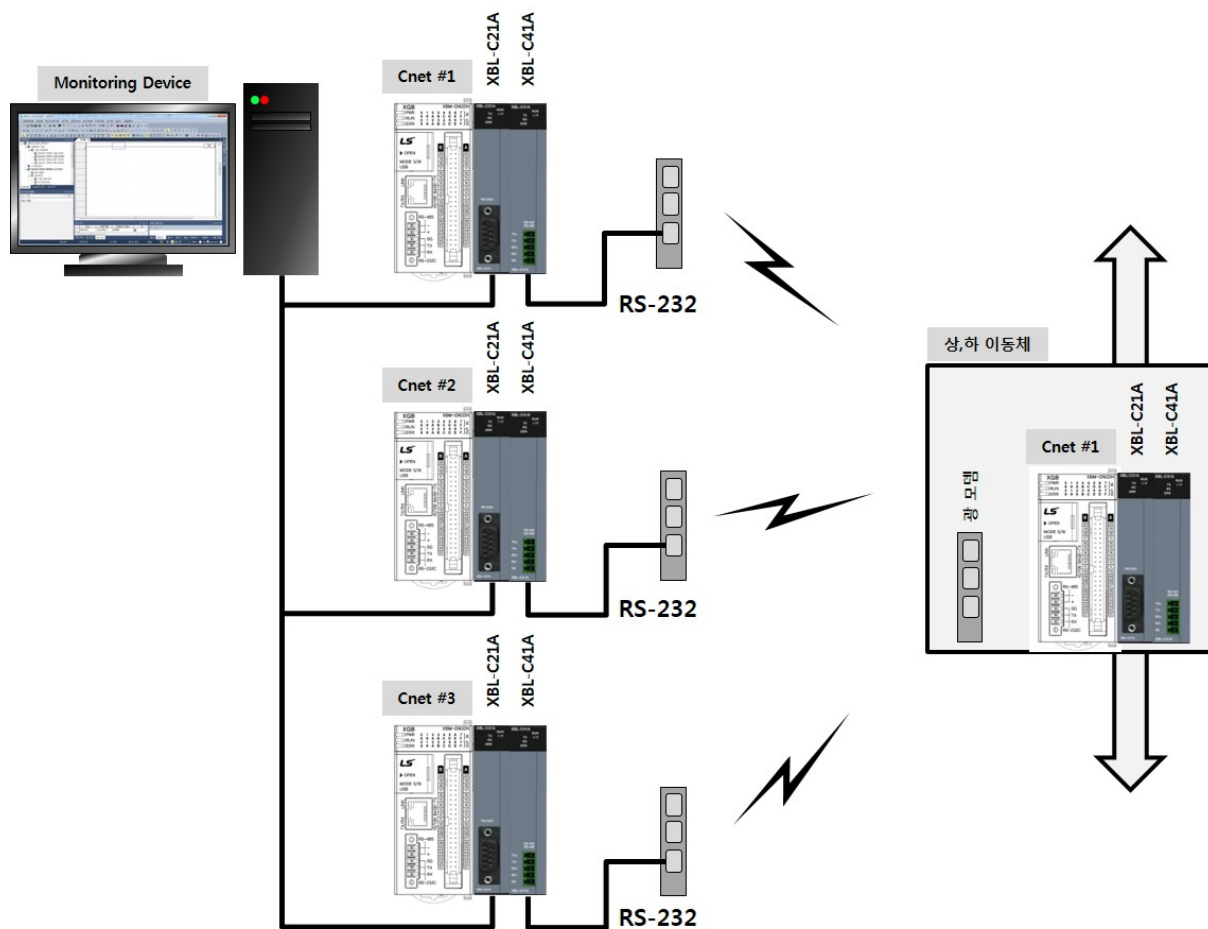

### 2.1.3 Wireless Modem Communication for Communication between Revolution Bodies

- Wireless modem communication system for Cnet communication on the revolution bodies
- RS-232C communication with wireless modem
- Communication between Cnet I/F module is dedicated/client communication
- RS-232C channel of Cnet I/F module is dedicated modem mode

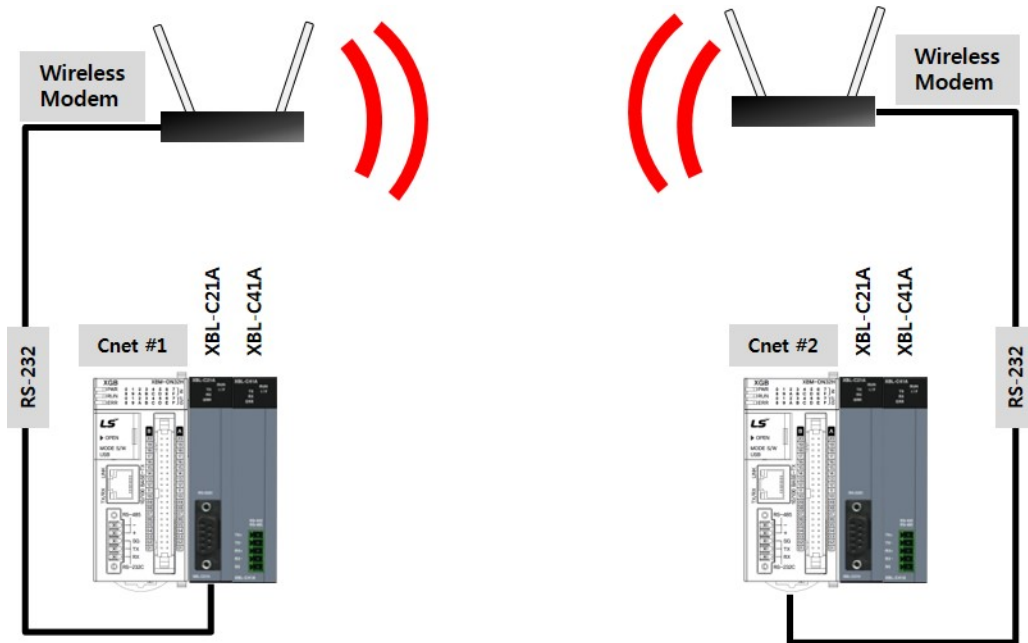

Type	Module setting		
	RS-232C	RS-422	Station
XBL-C21A	Dedicated mode	Not used	2 station
	User mode		

## 2.4 Basic Setting for Communication

### 2.4.1 PLC Type Setting and Communication Module Registration

To use Cnet I/F function, communication parameter should be written by XG5000 and the module should be registered in XG5000. Method on register Cnet I/F module is as follows according to On/Off line status.

#### 1) Making new project

First, after click Project-New Project and input project name, select XGB as CPU series.

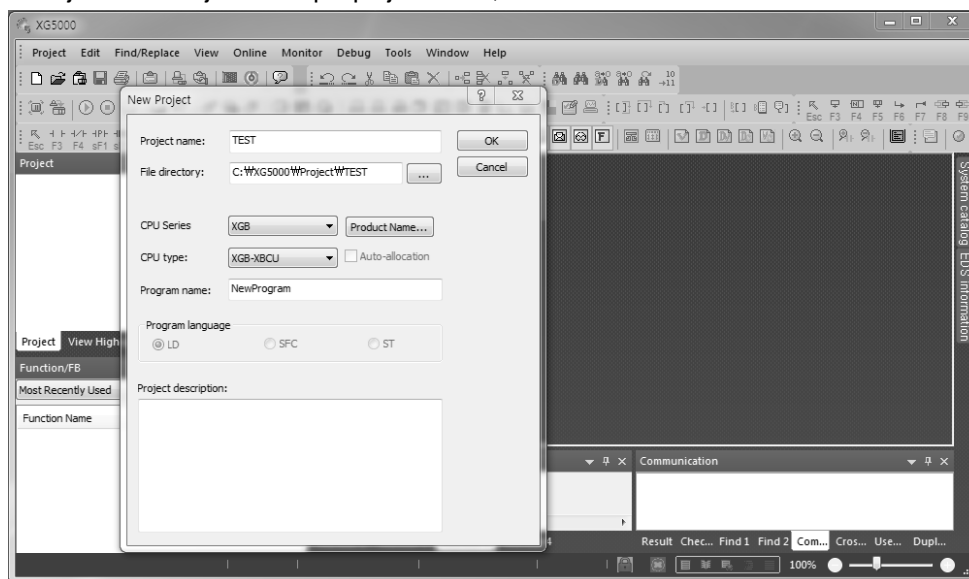

#### 2) In case of off-line, method on Cnet I/F module registration

In the status PLC is not connected, in case the user set about communication module and write parameter related with communication. In the “project” window, select “Basic Network” and then click mouse right button. Select “Add item – Communication module”. In the window, click “Add Module...” to register Cnet I/F module.

At this time, slot 0 is set as built-in Cnet. In case of using Cnet module other than built-in Cnet, registration is necessary.

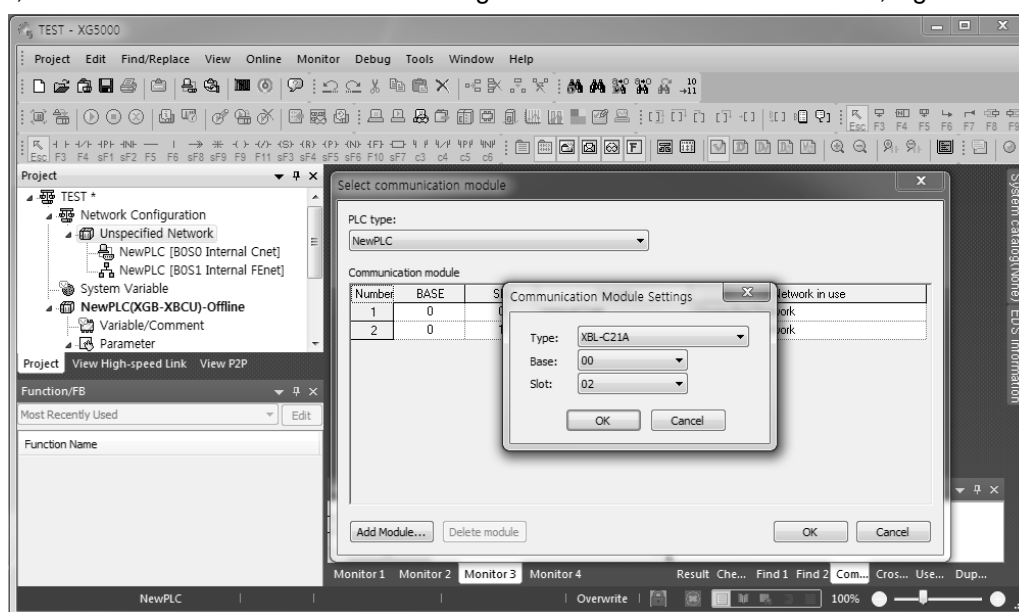

[ Cnet module registration ]

3) In case of on-line, method on Cnet I/F module registration

If you register communication module at online status by using XG5000, you should connect basic unit. After [Online]-> [Connect] after doing communication setting by using "Online -> Connection settings" and doing local connection. When selecting [Project] -> [Open from PLC], equipped communication module is searched automatically.

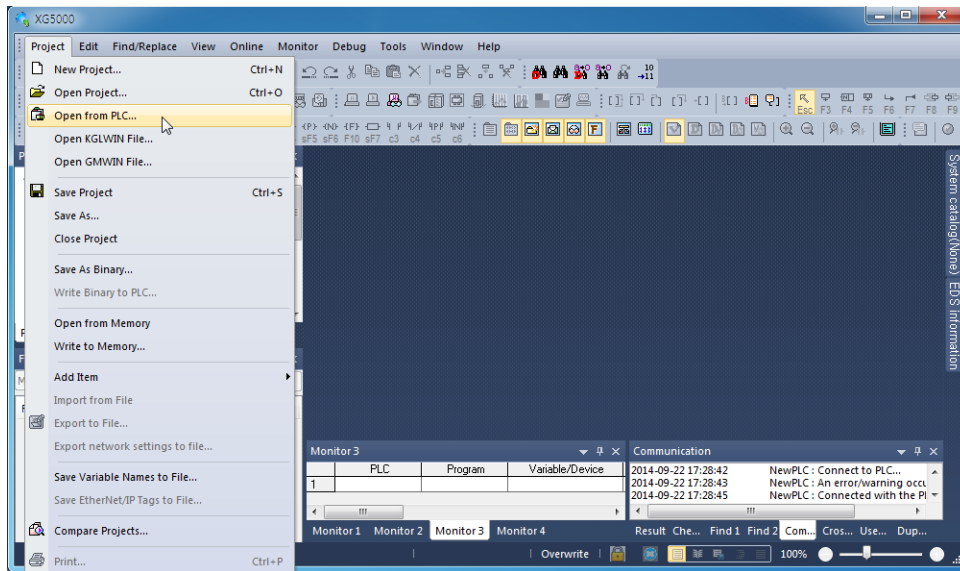

[ Screen of "Open from PLC" ]

At this time, in case registered module is different with currently connected module or type of communication module in the previous project, it shows whether it changes or not with the following message.

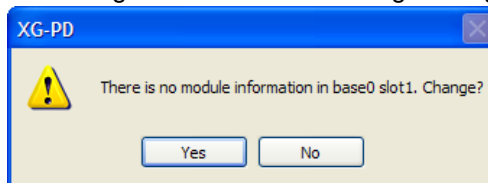

[I/O information change message ]

If you execute Read IO Information, equipped communication module like the following is indicated IO module information window.

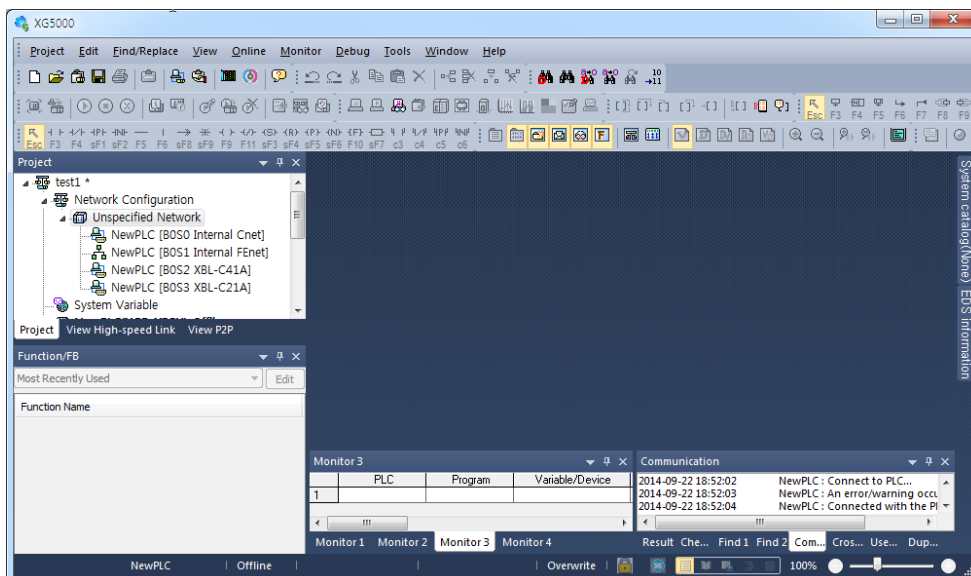

[Communication module registration complete screen ]

#### 4) How to read the parameter saved in PLC

The method to read basic setting value and P2P setting value of communication module saved in PLC is as follow. While connecting to main unit, select [Project] -> [ Open from PLC ]. After setting "Online Settings", click "OK" and then the saved parameter and project in PLC is opened as follow.

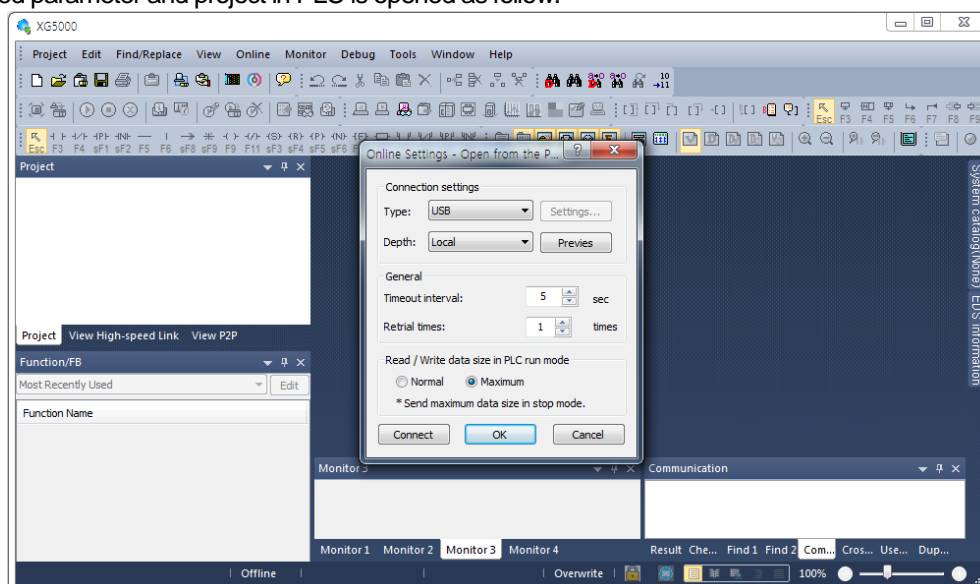

[ Open from PLC ]



## 2.4.2 Basic Parameter Setting

Communication function used in Cnet I/F module is classified as followings.

### 1) Server mode service

Without other program at PLC, you can read or write information in PLC and data.

- It can act as XGT server providing XGT dedicated protocol and Modbus server providing RTU/ASCII protocol.

### 2) Client (P2P) service

Cnet I/F module acts as client in network.

- In case designated event occurs, you can read or write memory of other station.
- It can act as XGT client and Modbus client.
- In case of sending/receiving user wanted frame and communicating with other device.
- You can define P2P block with max. 32 per one channel acting independently.

### 3) Loader service

By using remote 1/2, you can monitor/download program about remote PLC.

To use Cnet I/F module, you should set transmission specification such as data type like transmission speed and data/stop bit.

You should select transmission specification of system to be same with specification of system.

Written standard setting value is saved main unit of PLC and this value keeps though power goes off and this value is not changed before writing. Also though Cnet I/F module is changed and new module is installed, the standard setting value saved at main unit previously written is applied to new module automatically. Standard communication setting parameter and P2P, all parameter is applied if download is complete.

4) Setting Item

When setting Cnet communication parameter, the user should define as follows.

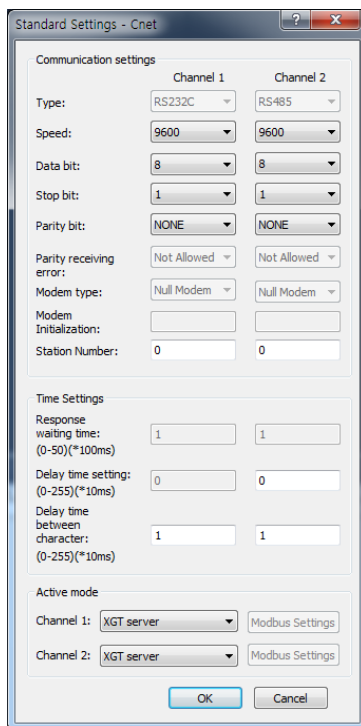

[Built-in communication standard setting screen ]

Item	Setting content
Station no.	• set from station 0 to station 255.
Speed	• 1200, 2400, 4800, 9600, 19200, 38400, 57600,76800, 115200 bps available
Data bit	• 7 or 8 bit available
Parity bit	• None, Even, Odd available
Stop bit	• 1 or 2 bit available
Modem initialization	• When using dialup modem, the function is available. In case of modem communication, input the initialization instruction of applied modem.
Type	• It is fixed as follows according to Cnet type 1) Built-in communication → channel 1 : RS-232C , channel 2 : RS-485 2) XBL-C41A → channel 1 : not used, channel 2: RS-422/RS-485 3) XBL-C21A → channel 1 : not used, channel 2: RS-232C
Response waiting time	• It means the time from sending frame to receiving. 1) operation setting : it is available when active mode is set to “Use P2P”. 2) waiting time : 100ms+(setting value × 100ms)
Delay time Setting	• It means that frame is sent at user-defined frame send timing with delay as setting delay time. 1) operation setting : it is available when communication type is RS-422/485.
Delay time between characters	• It means interval between characters in one frame. 1) operation setting : it is always available regardless of active mode. 2) In case of that wating time is set to 0, it is applied 3.5 character time <sup>1)</sup> as communication speed..

[ communication parameter setting item ]

The meaning of each items is as follows.

-Parity bit

Cnet I/F module can define three parity bits. Meaning of each parity bit is as follows.

Parity bit type	Meaning	Reference
None	Not using parity bit	
Even	If the number of 1 in one byte is even, parity bit becomes "0".	
Odd	If the number of 1 in one byte is odd, parity bit becomes "0".	

[ Parity content table ]

-Operation mode setting

▪ Sets operation mode

Driver type	Meaning	Reference
P2P	Each port acts as client and executes the communication by setting P2P parameter.	P2P setting reference
XGT server	It acts as XGT server supporting XGT dedicated communication.	Dedicated service
Modbus ASCII server	It acts as Modbus ASCII server	Modbus communication
Modbus RTU server	It acts as Modbus RTU server	Modbus communication

[ Operation mode setting item ]

**Note**

Character Time: It means the required time to send 1 character and it is variable depends on communication speed.

1) In case of that communication speed is 9600bps, how to calculate 3.5 Character Time

$$\begin{aligned} \text{Character time} &= (\text{number of bits of 1 character}(11)/\text{communication time}) * 3.5 \\ &= (11/9600)*3.5 \\ &= 4.01\text{ms} \end{aligned}$$

## Chapter 2 Built-in Cnet communication

### 5) Parameter download

You should do like following to operate Cnet I/F module according to communication specification defined by user. In case of setting like the followings about XBL-C41A (RS-422/485 1 port) installed slot 3, setting method is as follows.

#### (1) Communication specification

- Channel 2: RS-485, 115200Bps, 8/1/Odd, Null modem, P2P, station 0, Response waiting time 100ms, Delay time 10ms,

Waiting time between characters 0ms, XGT server

#### (2) Executing XG5000, you register communication module Cnet for setting at each slot position.

#### (3) After Cnet module is registered, if you double-click Cnet module, the following standard setting window shows.

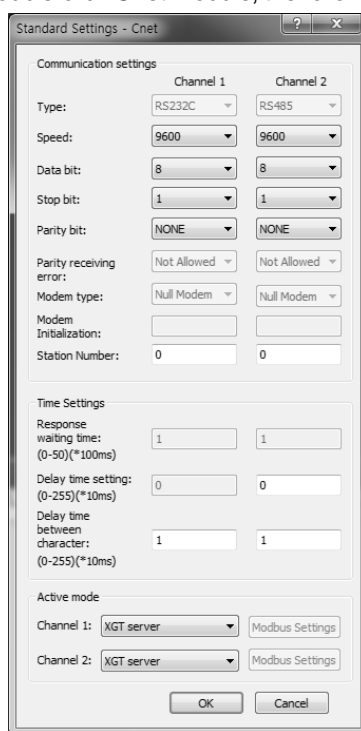

[Communication module setting screen ]

#### (4) If standard communication parameter setting ends, download Cnet module.

If you select [Online -> connection -> Write], download is executed. After downloading, parameter is applied shortly.

If you check 'Set up with Link Enable', Link Enable can be applied with writing P2P/HS parameters at the same time.

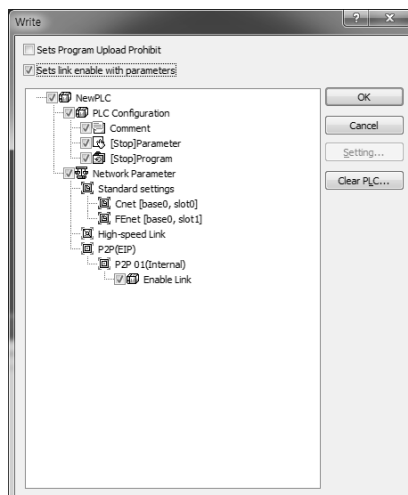

## 2.5 Server Function and P2P service

### 2.5.1 Server Function

Dedicated service is built-in service in Cnet I/F module. Without specific program at PLC, you can read or write information and data from PC and other device. It acts as server at communication network and if read, write request conforming XGT dedicated protocol or Modbus protocol come, it responds.

#### 1) XGT dedicated server

It is used in case of communication between our products by our dedicated service, all characters are configured as ASCII code. In case of using multi drop, up to 32 stations can be connected. In case of setting station number, duplicated station number should not be set. In case of using multi drop, communication speed/stop bit/parity bit/data bit of all Cnet I/F module in network should be same. For more detail protocol, refer to "chapter 2.7 XGT dedicated protocol".

#### 2) Modbus server

It is used in case partner device acts as Modbus client.

ASCII mode and RTU mode of Modbus are all supported. You can define in standard settings active mode. For more detail protocol, refer to "chapter 2.8 Modbus protocol".

Communication settings		Channel 1	Channel 2
Type:		RS232C	RS485
Speed:		9600	9600
Data bit:		8	8
Stop bit:		1	1
Parity bit:		NONE	NONE
Parity receiving error:		Not Allowed	Not Allowed
Modem type:		Null Modem	Null Modem
Modem Initialization:			
Station Number:		0	0

Time Settings		Channel 1	Channel 2
Response waiting time: (0-50)(*100ms)		1	1
Delay time setting: (0-255)(*10ms)		0	0
Delay time between character: (0-255)(*10ms)		1	1

Active mode		Channel 1	Channel 2
Channel 1:	XGT server	Modbus Settings	
Channel 2:	Modbus RTU server	Modbus Settings	

OK Cancel

Modbus instruction and response data max. number which is supported by Modbus RTU/ASCII driver are as follows. Other client device should request in the range of the following table.

Code	Purpose	Address	Max. no. of response data
01	Read Coil Status	0XXXX	2000 Coils
02	Read Input Status	1XXXX	2000 Coils
03	Read Holding Registers	4XXXX	125 Registers
04	Read Input Registers	3XXXX	125 Registers
05	Force Single Coil	0XXXX	1 Coil
06	Preset Single Register	4XXXX	1 Register
15	Force Multiple Coils	0XXXX	1968 Coils
16	Preset Multiple Registers	4XXXX	120 registers

### 2.5.2 P2P Service

P2P service means acting client operation of communication module. P2P instructions available at Cnet I/F module are 4 (Read/Write/Send/Receive).

Registration and edit of P2P service is executed in XG5000, each P2P parameter consists of max. 32 P2P block.

The following figure is example of P2P parameter setting window of XG5000.

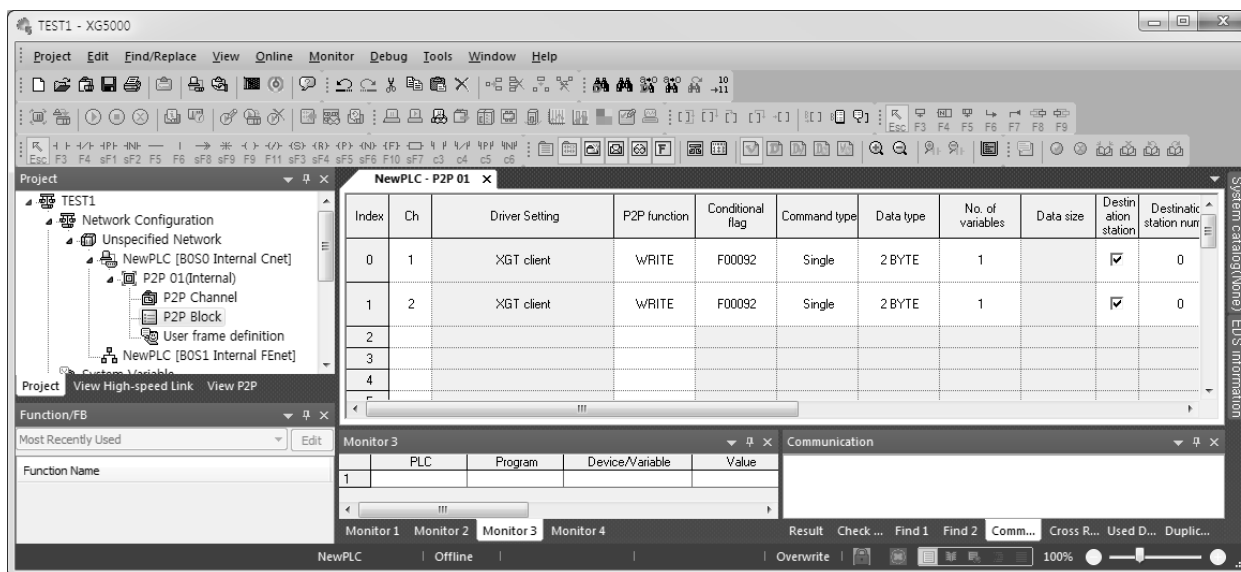

**Note**

P2P 01 is fixed allocated at built-in Cnet, and P2P 02 is fixed allocated at built-in FEnet. Therefore, it will operate normally with appropriate slot number.

1) P2P parameter configuration

To use P2P service, the user executes the setting for the wanted operation at the P2P parameter window. Like the following figure, P2P parameter consists of three informations.

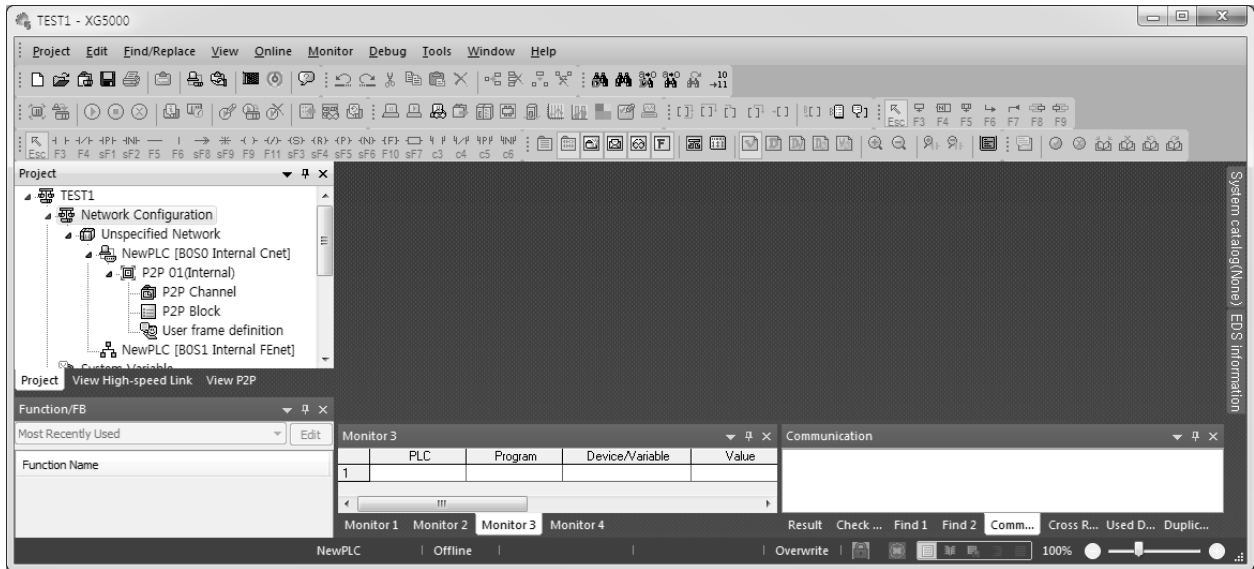

Types	Descriptions	Remark
P2P channel	<ul style="list-style-type: none"> <li>- P2P channel setting defining communication protocol of P2P service to execute</li> <li>- XGT/Modbus available</li> <li>- Each channel is independent. It is applied when active mode is "Use P2P settings"</li> </ul>	
P2P Block	Setting P2P block of 32 acting independently	
User frame definition	User frame definition registration	

## Chapter 2 Built-in Cnet communication

### 2) Channel Setting

Built-in Cnet I/F function provides two fixed communication channel as fixed P2P 1.

Cnet I/F module are allocated P2P 2 and P2P 3 according to equipment sequence and communication channel supports only one channel.

At Built-in Cnet I/F, you can define driver type for P2P service about each.

If you select P2P channel at P2P setting window, like the following, P2P channel setting window shows. If you select P2P driver to use, setting is complete.

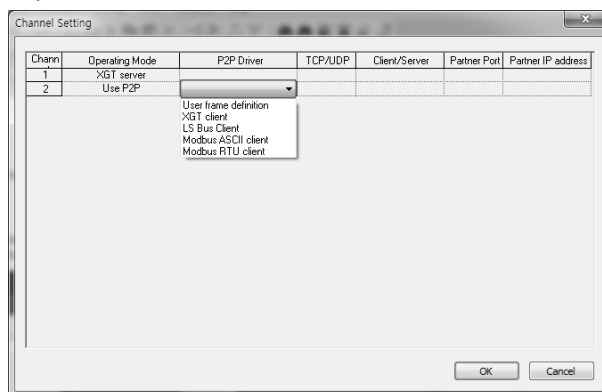

Driver	Meaning
None	Not using P2P service
User frame definition	In case of transmitting/receiving user frame definition
XGT client	Select in case of executing read, write of XGT memory.
Modbus ASCII client	Select in case of acting as Modbus client, using ASCII mode
Modbus RTU client	Select in case of acting as Modbus client, using RTU mode.

About communication channel, in case of selecting P2P driver as XGT or Modbus, user frame definition cannot be used.

### 3) Block information

If you select P2P block of each parameter at P2P parameter setting window, P2P block setting window shows. Setting value of P2P block will be displayed differently as user sets the P2P Driver of channel.

P2P Channel			P2P Block Setting												
Channel	Operating Mode	P2P Driver	NewPLC - P2P 01 X												
1	Use P2P	XGT client	Index	Ch	Driver Setting	P2P function	Conditional flag	Command type	Data type	No. of variables	Data size	Destination station	Destination station number	Frame	Setting
			0	1	XGT client							<input checked="" type="checkbox"/>	0		Setting
Channel	Operating Mode	P2P Driver	NewPLC - P2P 01 X												
1	Use P2P	Modbus ASCII client	Index	Ch	Driver Setting	P2P function	Conditional flag	Command type	Data type	No. of variables	Data size	Destination station	Destination station number	Frame	Setting
			0	1	Modbus ASCII client					1		<input checked="" type="checkbox"/>	0		Setting
Channel	Operating Mode	P2P Driver	NewPLC - P2P 01 X												
2	Use P2P	Modbus RTU client	Index	Ch	Driver Setting	P2P function	Conditional flag	Command type	Data type	No. of variables	Data size	Destination station	Destination station number	Frame	Setting
			0	2	Modbus RTU client					1		<input checked="" type="checkbox"/>	0		Setting
Channel	Operating Mode	P2P Driver	NewPLC - P2P 01 X												
2	Use P2P	User frame definition	Index	Ch	Driver Setting	P2P function	Conditional flag	Command type	Data type	No. of variables	Data size	Destination station	Destination station number	Frame	Setting
			0	2	User frame definition										Setting

[ P2P block setting screen ]



You can set up to 32 independent blocks. If you select temporary block, you can designate each block operation by selecting instruction.

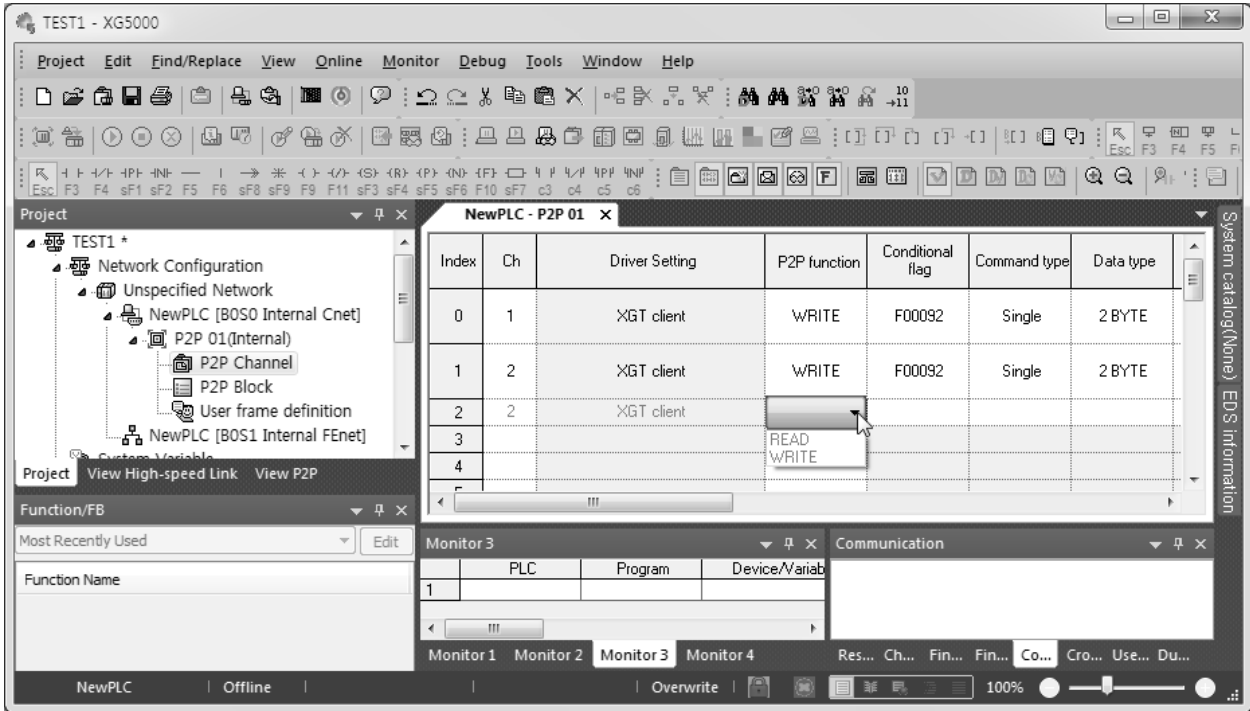

[ P2P instruction screen ]

### 2.5.3 XGT Client Service

When using the XGT protocol, XGT client requests writing/reading the data. XGT server analyzes the received data. In case of normal frame, XGT server deals with the received data with ACK response and in case of abnormal frame, XGT transmits the NAK response including error code to XGT client.

#### 1) Channel setting

Cnet I/F module is available to define driver type for P2P service about each channel. However, active mode in the standard settings should be set as "Use P2P settings". P2P setting according to active mode is as follows.

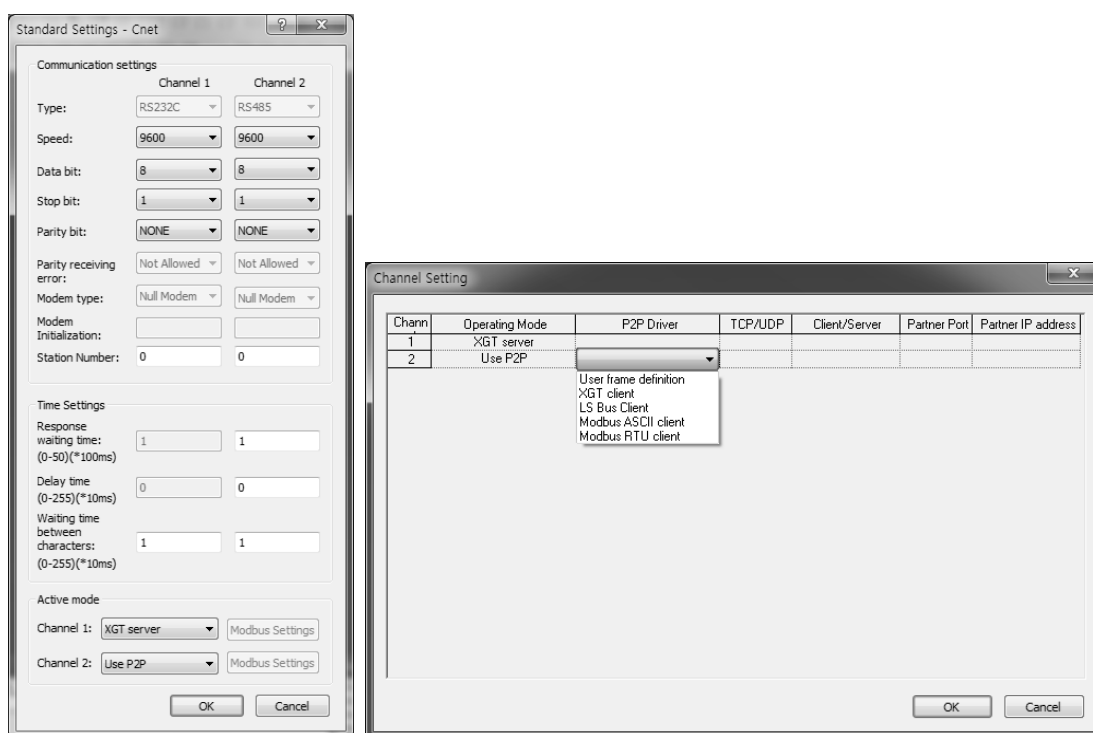

#### 2) P2P block setting





If selecting P2P block in the P2P parameter setting window, P2P block setting window shows.

Block setting window is same according to protocol and activated area is different P2P. Each of items means as follow.

Index	Ch	Driver Setting	P2P function	Conditional flag	Command type	Data type	No. of variables	Data size	Destination station	Destination station number	Frame	Setting
0	2	XGT client							<input checked="" type="checkbox"/>	0		Setting
	①		②	③	④	⑤	⑥	⑦	⑧	⑨		⑩

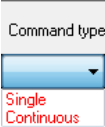
No.	Type	Block form	Contents
1	Channel		Driver name changes according to driver set in the P2P Driver.
2	P2P function		1. Read : when reading the destination station's memory 2. Write: when writing self-station's memory to destination station's memory.
3	Conditional flag		1. Determines when Cnet sends request frame 2. In case of XBC type Ex. : F90(20ms flag), M01 3. In case of XEC type Ex. : _T20MS(20ms flag), %MX01

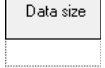
## Chapter 2 Built-in Cnet communication

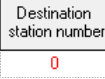
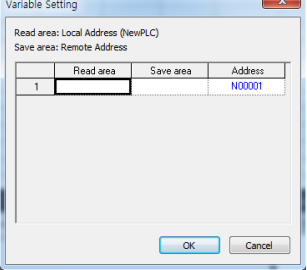
No.	Type	Block form	Contents
4	Command type		<ol style="list-style-type: none"> <li>Single: When reading/writing max. 4 memory areas. (Ex. : M01, M10, M20, M30)</li> <li>Continuous: When reading/writing continuous memory areas. (Ex. : M01~M10)</li> </ol>
5	Data type		<ol style="list-style-type: none"> <li>In case that command type is single: bit, 1 byte, 2byte, 4 byte, 8 byte available</li> <li>In case that command type is continuous: 1 byte, 2byte, 4 byte, 8 byte</li> </ol>
6	No. of variable		<ol style="list-style-type: none"> <li>This is activated when command type is single and available max. no. is 4.</li> <li>When command type is continuous, it is fixed as 1.</li> </ol>
7	Data size		<ol style="list-style-type: none"> <li>This is activated when command type is continuous.</li> <li>When data type is 1 byte, available max. no. is 120 byte</li> </ol>
8	Destination station		<ol style="list-style-type: none"> <li>Check: Specify the destination station</li> <li>Uncheck: In case of using P2PSN command, communicate with previously designated (P2PSN)destination station</li> </ol>
9	Destination station number		<ol style="list-style-type: none"> <li>Destination station number, setting range is 0~63.</li> </ol>
10	Setting		<ol style="list-style-type: none"> <li>When P2P function is Read               <ol style="list-style-type: none"> <li>1)Read area : device area of server</li> <li>2)Save area : client's device to save the data from server</li> </ol> </li> <li>When P2P function is Write               <ol style="list-style-type: none"> <li>1)Read area : device area of client</li> <li>2)Save area : Server's device area to save client's data</li> </ol> </li> </ol>

### 3) Writing parameter

After P2P block setting is completed, download setting parameter to CPU.

Select [Online] – [Connect] – [Write], and click OK in parameter download window, and then it will be downloaded.

After download, the parameter is applied immediately. If you check 'Set up with Link Enable', Link Enable can be applied with writing P2P/HS parameters at the same time.

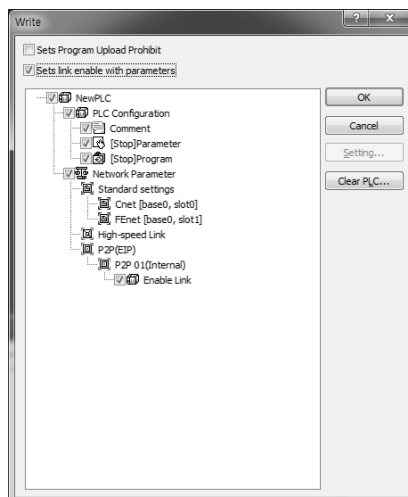

### 4) Enabling link

After setting P2P parameter and downloading the parameter to PLC CPU, enable P2P service. If parameter is downloaded but P2P(EIP) is not enabled, the P2P block is not operated. In order to enable P2P(EIP), Select [Online] – [Communication module setting] – [Enable Link], and click P2P(EIP) number which you want to operate and then click Write button. The P2P(EIP) is enabled.

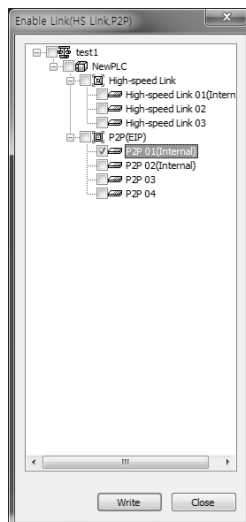

### 5) Diagnosis service

In order to check the setting parameter operates normally, diagnosis service is available.

Select [Online] – [Communication module setting] – [System Diagnosis]. Click the module and then click mouse right-button. If you select Frame Monitor or Status by Service, it can be checked whether the communication is normal or not. For more detail, refer to chapter 2.9 Diagnosis Function.

### 2.5.4 Modbus Client Service

Modbus protocol is specified open protocol used between client-server, which executes reading/writing data according to function code. Communication between devices that use Modbus protocol uses Client-server function in which only one client processes the data.

#### 1) Channel setting

Cnet I/F module is available to define driver type for P2P service about each channel. However, active mode in the standard settings should be set as "Use P2P settings".

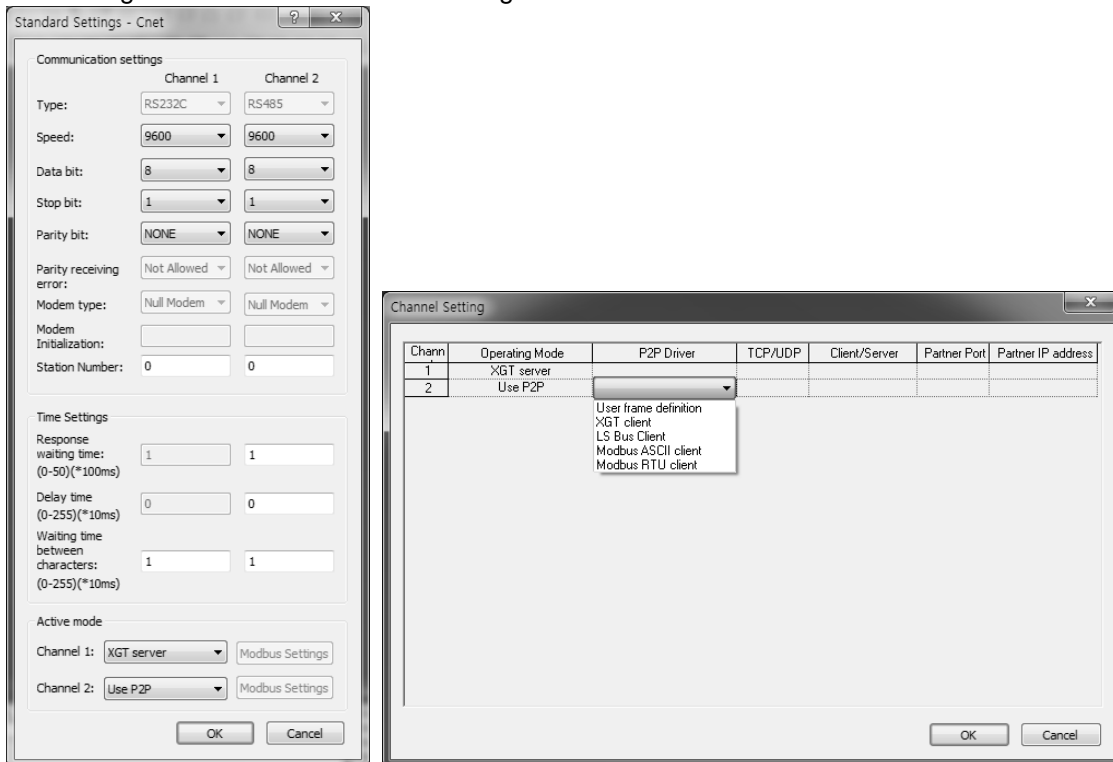



#### 2) P2P block setting

There are two commands; Write (writes memory of self station to destination station's memory area) and Read (reads memory of destination memory and saves it in the memory area of self station)

Setting methods of both RTU and ASCII clients are same.

Index	Ch	Driver Setting	P2P function	Conditional flag	Command type	Data type	No. of variables	Data size	Destination station	Destination station number	Frame	Setting
0	2	Modbus RTU client					1		<input checked="" type="checkbox"/>	0		Setting
	①		②	③	④	⑤	⑥	⑦	⑧		⑨	

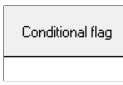
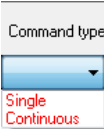
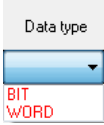
No.	Type	Block type	Meaning
1	Channel		Driver name changes according to driver set in the P2P Driver.
2	P2P function		1. Read : when reading the destination station's memory 2. Write: when writing self-station's memory to destination station's memory.

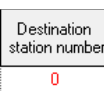
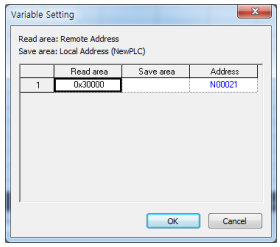
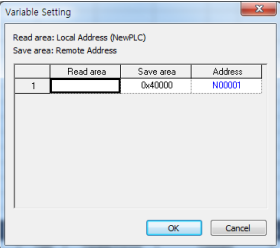
No.	Type	Block type	Meaning
3	Conditional flag		<ol style="list-style-type: none"> <li>1. Determines when Cent sends frame</li> <li>2. In case of XBC type Ex. : F90(20ms flag), M01</li> <li>3. In case of XEC type Ex. : _T20MS(20ms flag), %MX01</li> </ol>
4	Command type		<ol style="list-style-type: none"> <li>1. single: When reading/writing max. 4 memory areas. (Ex. : M01, M10, M20, M30)</li> <li>2. continuous: When reading/writing continuous memory areas. (Ex. : M01~M10)</li> </ol>
5	Data type		Data type can be bit or word.
6	Data size		<p>▷ Determines size of data to communicate and it is activated when command type is continuous.</p> <ol style="list-style-type: none"> <li>1. when P2P function is Read <ol style="list-style-type: none"> <li>1) Modbus RTU client <ol style="list-style-type: none"> <li>(1)Bit type : 1~2000</li> <li>(2)Word type : 1~125</li> </ol> </li> <li>2) Modbus ASCII client <ol style="list-style-type: none"> <li>(1)Bit type : 1~976</li> <li>(2)Word type : 1~61</li> </ol> </li> </ol> </li> <li>2. when P2P function is Write <ol style="list-style-type: none"> <li>1) Modbus RTU client <ol style="list-style-type: none"> <li>(1)Bit type : 1~1968</li> <li>(2)Word type : 1~123</li> </ol> </li> <li>2) Modbus ASCII client <ol style="list-style-type: none"> <li>(1)Bit type : 1~944</li> <li>(2)Word type : 1~125</li> </ol> </li> </ol> </li> </ol>
7	Destination station		<ol style="list-style-type: none"> <li>1. It is checked automatically.</li> <li>2. In case that the user doesn't want to use relevant block, remove the check indication. Then that block doesn't work.</li> </ol>
8	Destination station number		<ol style="list-style-type: none"> <li>1. Destination station number, setting range is 0~31.</li> </ol>
9	Setting		<p>▶ When P2P function is Read</p> <ol style="list-style-type: none"> <li>1. Read area: device area of server <ol style="list-style-type: none"> <li>1) Bit: bit input (0x10000), bit output (0x00000)</li> <li>2) Word: word input (0x30000), word output (0x40000)</li> </ol> </li> <li>2. Save area: client's device to save the data</li> </ol>
			<p>▶ When P2P function is Write</p> <ol style="list-style-type: none"> <li>1. Read area: device area of self station</li> <li>2. Save area: server's device area to save the data <ol style="list-style-type: none"> <li>1) Bit: bit input (0x10000), bit output (0x00000)</li> <li>2) Word: word input (0x30000), word output (0x40000)</li> </ol> </li> </ol>

### 3) Writing parameter

After P2P block setting is completed, download setting parameter to CPU.

Select [Online] – [Connect] – [Write], and click OK in parameter download window, and then it will be downloaded.

After download, the parameter is applied immediately. If you check 'Set up with Link Enable', Link Enable can be applied with writing P2P/HS parameters at the same time.

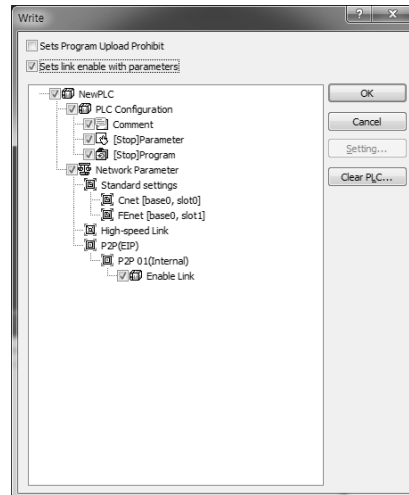

### 4) Enabling link

After setting P2P parameter and downloading the parameter to PLC CPU, enable P2P service. If parameter is downloaded but P2P(EIP) is not enabled, the P2P block is not operated. In order to enable P2P(EIP), Select [Online] – [Communication module setting] – [Enable Link], and click P2P(EIP) number which you want to operate and then click Write button. The P2P(EIP) is enabled.

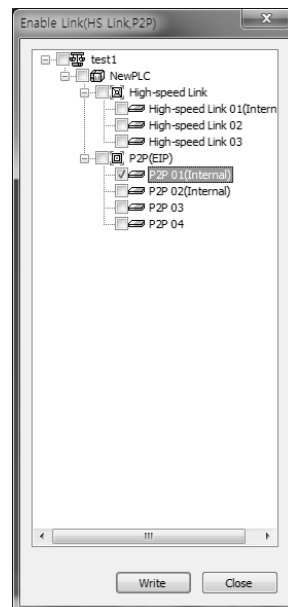

### 5) Diagnosis service

In order to check the setting parameter operates normally, diagnosis service is available.

Select [Online] – [Communication module setting] – [System Diagnosis]. Click the module and then click mouse right-button. If you select Frame Monitor or Status by Service, it can be checked whether the communication is normal or not. For more detail, refer to chapter 2.9 Diagnosis Function.

### 2.5.5 User-defined Communication Service

There are many protocols according to producer of communication device and it is impossible to supports diverse protocols. So if the user defines protocols and writes program, Cnet I/F module allows the communication between different devices according to defined protocol. In order to communicate with device which doesn't use specific protocols (XGT protocol, Modbus protocol), the user can directly define protocol used in the device the user want to communicate and communicate. At this time, the user should define TX and RX frame so that it meets partner device's protocol.

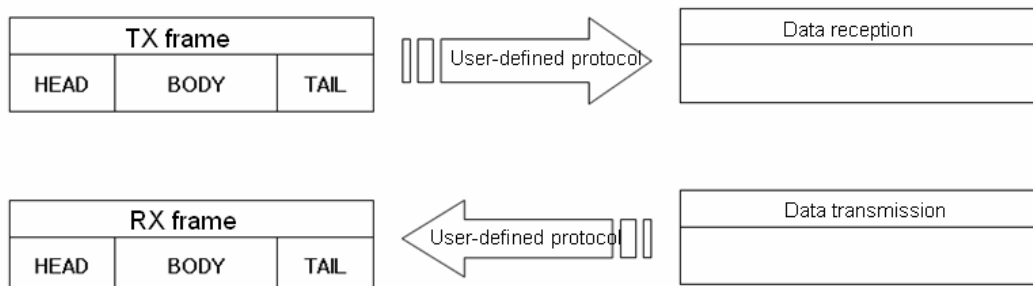

#### 1) Structure of user-defined frame

When writing frame by user definition frame, frame is divided into HEAD, TAIL and BODY generally and each HEAD, TAIL and BODY is divided into segment. Total size of one frame should be less than 1024 byte.

Frame		
HEAD	BODY	TAIL
Segment 1	Segment 1	Segment 1
Segment 2	Segment 2	Segment 2
Segment 3	Segment 3	Segment 3
Segment N	Segment N	Segment N

#### (1) Structure of HEAD

Input type of segment for HEAD is divided into numerical constant and string constant. In case of numerical constant, it means HEX value and in case of string constant, it means ASCII value.

#### (2) Structure of TAIL

Input type of segment for HEAD is divided into numerical constant, string constant and BCC which check frame error. Meaning of numerical constant and string constant is same with HEAD's. BCC is segment used for checking TRX frame error, only one can be set in the TAIL.



a) BCC error check

When BCC is applied, calculation about TRX frame is executed and if calculation is different, relevant frame is ignored to improve the reliability of communication. Calculation methods about each BCC are as follows.

Classification	BCC method	Contents description
General method checking error	Byte SUM	Adds designated data as 1 byte unit and uses lower byte value
	Word SUM	Adds designated data as 1 word unit and uses lower word value
	Byte XOR	Executes Exclusive OR calculation about designated data as 1 byte unit and uses lower byte
	7bit SUM	Uses result value of byte sum except the most significant bit
	7bit XOR	Uses result value of byte XOR except the most significant bit
	7bit SUM#1	If result of 7 bit SUM is less than 20 <sub>H</sub> , it adds 20 <sub>H</sub> .
	Byte SUM 2'S COMP	Takes 2's complement about byte sum result
	Byte SUM 1'S COMP	Takes 1's complement about byte sum result
	CRC 16	16 bit error detection method
	CRC 16 IBM	16 bit IBM CRC error detection method
	CRC 16 CCITT	16 bit CCITT CRC error detection method
	MODBUS LRC	MODBUS LRC error detection method
Method checking error for dedicated communication	LS CRC	Error detection method used for LS PLC
	DLE AB	Error detection method used for DF1 Protocol of Allen Bradley
	DLE SIEMENS	Error detection method used for Siemens 3964R communication

When setting BCC, in case of general method, the user need not set BCC setting range and indication method and in case of dedicated method, the user should set BCC setting range and indication method.

Item		Contents
Start position	Start area	Determines where BCC calculation starts from among HEAD/BODY/TAIL
	Segment	Determines segment location to start BCC calculation in HEAD/BODY/TAIL. 0 means first segment will be included in the BCC calculation
End position	Before BCC	Included from start position to before BCC
	End of area	Included from start position to end of designated area
	Settings	Included from start position to designated area segment
ASCII conversion		Converts result value, its size will be double
Initial value 0		Designates BCC initial value as 0. If there is no designation, initial value is FF <sub>H</sub> .

## Chapter 2 Built-in Cnet communication

### (3) Structure of BODY

Input type of segment which composes BODY is different according to reception and transmission.

In case of transmission, they are divided into string constant, numerical constant and fix sized variable. Meaning of string constant and numerical constant is same with HEAD's.

#### a) Variable sized variable (in RX frame)

Part where size and contents changes are defined as variable sized variable. Variable sized variable can be set in the BODY and after variable sized variable, the user can't add segment. When using variable sized variable, there should be one among HEAD, TAIL. If the user registers variable sized variable without HEAD, TAIL, when receiving frame, there may be error according to communication status. For reliability of communication, register one among HEAD, TAIL. (In case of Variable sized variable of TX frame, the size is designated in P2P Block setting, so the function and characteristic is same with Fix sized variable of RX frame.)

#### b) Fix sized variable (in RX frame)

Frame part where size is fixed but contents changes are defined as Fix sized variable. It can be set in the BODY. In case of Fix sized variable, the user can register up to 4.

TRX frame standard for user - defined communication of XGB Cnet I/F module is as follows.

Group	Frame	Segment	Reference
TX frame	HEAD	Numerical constant	Max. 10 byte
		String constant	Max. 10 byte
	TAIL	Numerical constant	Max. 10 byte
		String constant	Max. 10 byte
		BCC	Only one BCC applicable
	BODY	Numerical constant	Max. 10 byte
		String constant	Max. 10 byte
Variable sized variable		Available up to 4	
RX frame	HEAD	Numerical constant	Max. 10 byte
		String constant	Max. 10 byte
	TAIL	Numerical constant	Max. 10 byte
		String constant	Max. 10 byte
		BCC	Only one BCC applicable
	BODY	Numerical constant	Max. 10 byte
		String constant	Max. 10 byte
		Fix sized variable	Available up to 4 Fix sized variable 3, variable sized variable 1 are available
		Variable sized variable	Only one variable sized variable available After variable sized variable, adding segment is impossible

2) Channel setting

Cnet I/F module is available to define driver type for P2P service about each channel. However, active mode in the standard settings should be set as "Use P2P settings".

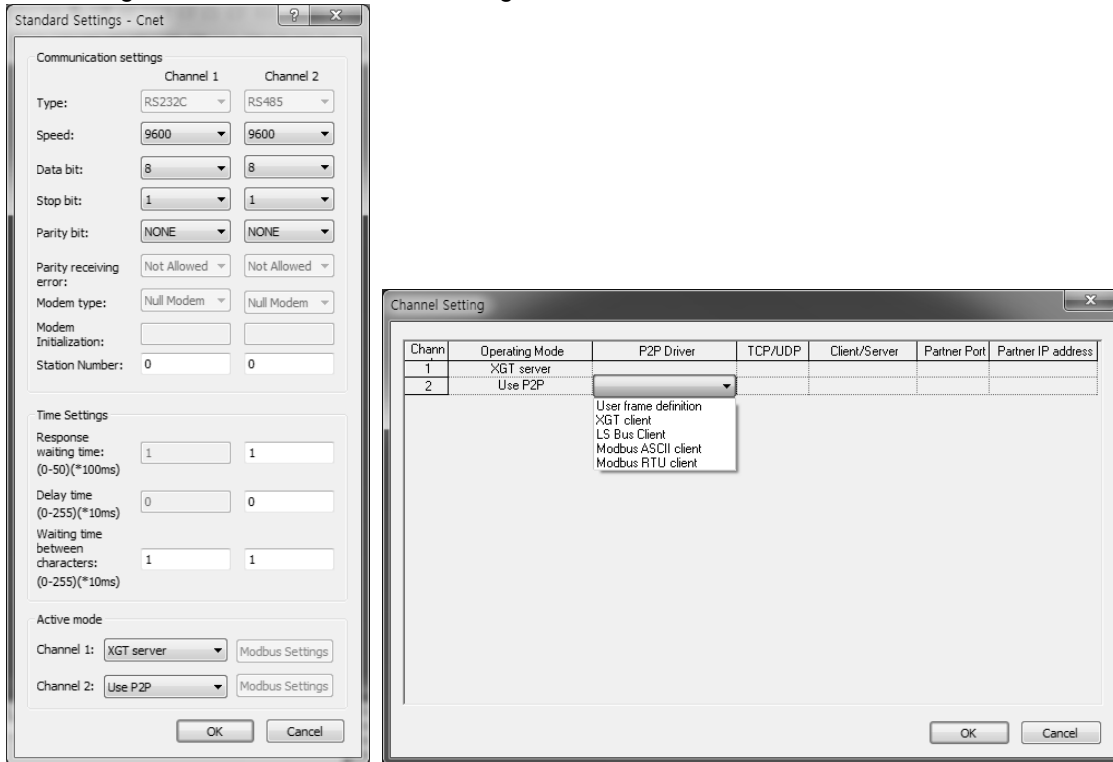

3) Set-up transmission frame

Frame is composed of HEAD indicating start, TAIL indicating end and BODY which is data area. How to write transmission frame is as follows.

Sequence	Setting contents	Setting method
1	Writing user frame definition	
		<ol style="list-style-type: none"> <li>1. Select User frame definition.</li> <li>2. Click right button of mouse and click Add Group</li> </ol>
2	Creating frame	
		<ol style="list-style-type: none"> <li>1. Group name is name of frame for user to write.</li> <li>2. Select Transmission as frame type.</li> </ol>

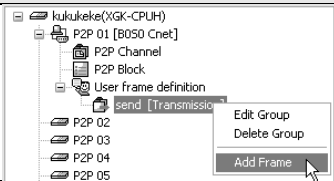
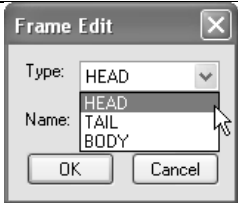
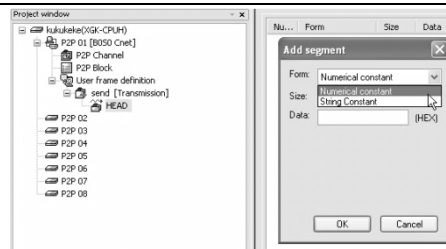
Sequence	Setting contents	Setting method
3	Creating frame	
4	Creating HEAD, TAIL, BODY	
5	HEAD registration	

1. Check creation of frame.
2. Select frame name and click right button of mouse.
3. Click Add Frame to create HEAD, TAIL and BODY.
4. Group Edit: when changing frame name.
5. Delete Group: when deleting frame.



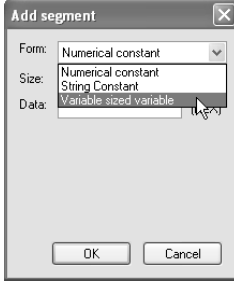

1. After clicking Add Frame, select type of frame.
2. type: HEAD, TAIL, BODY
3. Select HEAD.
4. To create TAIL, BODY, repeat step 3.
5. Name of frame edit window is activated when frame type is BODY.
6. Available to creating many BODYs with different name.

1. Double-click HEAD. Then edit window is created.
  2. Double-click edit window or click right button and select Add segment.
  3. Select Form.
    - 1) Numerical constant
      - (1) Defines numerical constant among frame
      - (2) Data value is always Hex (Hexadecimal)
    - 2) String constant
      - (1) Registers string constant among frame
      - (2) Data value is always ASCII
  4. Input value into Data.
 

Ex.) Form: Numerical constant  
Data: 5(ENQ)
- \* When clicking the right button on the created segment, edit, deletion, insertion, copy, etc. are available.

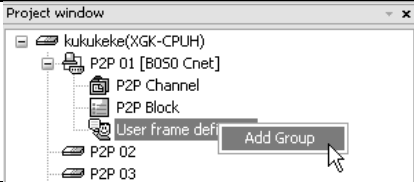
Sequence	Setting contents	Setting method
6	TAIL registration	<ol style="list-style-type: none"> <li>1. If double-click TAIL, edit window shows.</li> <li>2. Setting method is same with step 5.</li> <li>3. Add BCC is activated after inserting segment.</li> </ol>
7	BODY registration	
		<ol style="list-style-type: none"> <li>1. Double-click BODY and select data form.               <ol style="list-style-type: none"> <li>1) Numerical constant and string constant are same as described above.</li> <li>2) Variable sized variable                   <ol style="list-style-type: none"> <li>(1) used when frame length change</li> <li>(2) available to insert up to 4 for one body</li> <li>(3) 'Assign memory' is checked automatically</li> <li>(4) Control by byte unit</li> </ol> </li> <li>3) Conversion                   <ul style="list-style-type: none"> <li>▶ Hex To ASCII: converts the data red from PLC into ASCII and configures transmission frame</li> <li>▶ ASCII To Hex: converts the data red from PLC into Hex and configures transmission frame</li> </ul> </li> <li>4) Swap                   <ul style="list-style-type: none"> <li>▶ 2 Byte swap: 2 byte swap of data (ex.: 0x1234-&gt;0x3412)</li> <li>▶ 4 Byte swap: 4 byte swap of data (ex.: 0x12345678-&gt;0x78564321)</li> <li>▶ 8 Byte swap: 8 byte swap of data</li> </ul> </li> </ol> </li> </ol>

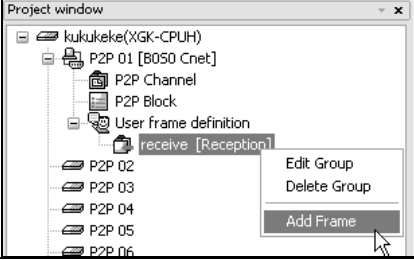
4) Set-up reception frame

Sequence	Setting method	Setting method
1	Writing user-defined frame	
	<p>1. Select User frame definition. 2. Click the right button of mouse and select Add Group.</p>	
2	Creating frame	
	<p>1. Group name is name of frame for user to write. 2. Select Reception as frame type.</p>	
3	Creating frame	
	<p>1. Check creation of frame. 2. Select frame name and click right button of mouse. 3. Click Add Frame to create HEAD, TAIL and BODY. 4. Group Edit: when changing frame name. 5. Delete Group: when deleting frame.</p>	
4	Creating HEAD, TAIL, BODY	
	<p>1. After clicking Add Frame, select type of frame. 2. type: HEAD, TAIL, BODY 3. Select HEAD. 4. To create TAIL, BODY, repeat step 3. 5. Name of frame edit window is activated when frame type is BODY. 6. Available to creating many BODYs with different name.</p>	

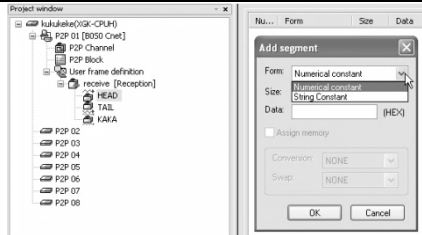
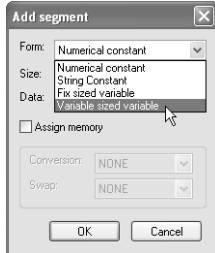
Sequence	Setting method	Setting method
5	HEAD registration	 <p>1. Double-click HEAD. Then edit window is created.                  2. Double-click edit window or click right button and select Add segment.                  3. Select Form.                      1) Meaning of each form is same as described in the transmission.                  4. Input value into Data.</p>
6	TAIL registration	<p>1. If double-click TAIL, edit window shows.                  2. Setting method is same with step 5.                  3. Add BCC is activated after inserting segment.</p>
7	BODY registration	 <p>1. Double-click BODY and select data form.                      1) Numerical constant and string constant are same as described above.                      2) Variable sized variable                          (1) used when frame length changes                          (2) Available to insert only one variable sized variable and it is impossible to add segment after variable sized variable                          (3) When checking [Assign memory], it is available to save in the PLC memory                          (4) Control by byte unit                      3) Fix sized variable                          (1) Used when frame size is fixed.                          (2) available to insert up to 4 for one body                          (3) When checking [Assign memory], it is available to save in the PLC memory                  4) Assign memory: when setting the device area of PLC to save data.                  5) Conversion                      ▶ Hex To ASCII: converts the data received into ASCII and configures reception frame                      ▶ ASCII To Hex: converts the data received into Hex and configures reception frame                  6) Swap                      ▶ 2 Byte swap: 2 byte swap of data (ex.: 0x1234-&gt;0x3412)                      ▶ 4 Byte swap: 4 byte swap of data (ex.: 0x12345678-&gt;0x78564321)                      ▶ 8 Byte swap: 8 byte swap of data</p>

## Chapter 2 Built-in Cnet communication

### 5) Setting parameter

To send and receive the user definition frame of XG5000, the user should set the parameter by P2P block. How to set the P2P block is as follows.

Index	Ch	Driver Setting	P2P function	Conditional flag	Command type	Data type	No. of variables	Data size	Destination station	Destination station number	Frame	Setting
0	2	User frame definition										Setting
		①	②	③							④	⑤

No.	Type	Block type	Meaning
1	Channel		Driver name changes according to driver set in the P2P Driver.
2	P2P Function		<ol style="list-style-type: none"> <li>1. Receive: used when receiving the frame written according to partner's protocol</li> <li>2. Send: used when sending the frame written according to partner's protocol</li> </ol>
3	Conditional flag		<ol style="list-style-type: none"> <li>1. Determines when Cent sends frame</li> <li>2. It is activated when P2P function is [Send].</li> <li>3. In case of XBC type Ex.: F90(20ms flag), M01</li> <li>4. In case of XEC type Ex.: _T20MS(20ms flag), %MX01</li> </ol>
4	Frame		1. In case of selecting [SEND] in the P2P function, select body of transmission frame written in the user definition frame.
			1. In case of selecting [RECEIVE] in the P2P function, select body of reception frame written in the user definition frame.
5	Setting		<ol style="list-style-type: none"> <li>1. Setting is available when [Assign memory] of Fix sized variable and variable sized variable is checked.</li> <li>2. Save area: start address to save the data received from destination station.</li> </ol>

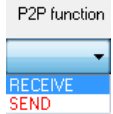
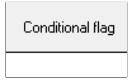
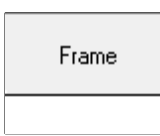
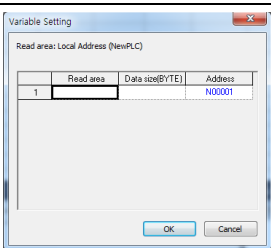

### 6) Writing parameter

After P2P block setting is completed, download setting parameter to CPU.

Select [Online] – [Connect] – [Write], and click OK in parameter download window, and then it will be downloaded.

After download, the parameter is applied immediately. If you check 'Set up with Link Enable', Link Enable can be applied with writing P2P/HS parameters at the same time.

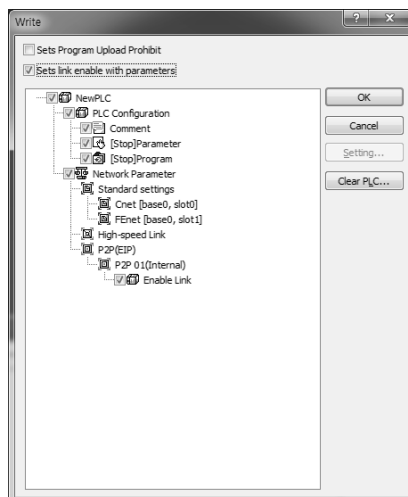

### 7) Enabling link

After setting P2P parameter and downloading the parameter to PLC CPU, enable P2P service. If parameter is downloaded but P2P(EIP) is not enabled, the P2P block is not operated.

In order to enable P2P(EIP), Select [Online] – [Communication module setting] – [Enable Link], and click P2P(EIP) number which you want to operate and then click Write button. The P2P(EIP) is enabled.

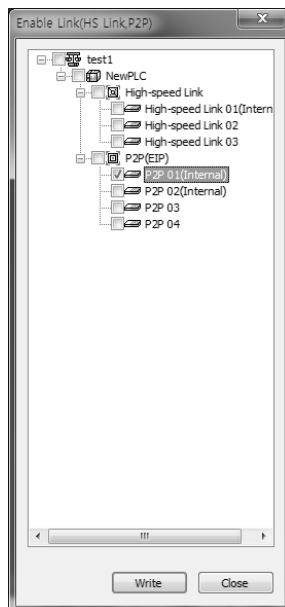

### 8) Diagnosis service

In order to check the setting parameter operates normally, diagnosis service is available.

Select [Online] – [Communication module setting] – [System Diagnosis]. Click the module and then click mouse right-button. If you select Frame Monitor or Status by Service, it can be checked whether the communication is normal or not. For more detail, refer to chapter 2.9 Diagnosis Function.

### 2.5.6 LS Bus Client

LS Bus Protocol communication is function executing communication between XGB Cnet and LS Inverter. User can configure LS Bus communication system between our products without special setting by using reading/writing data of internal device area and monitoring function

#### 1) Channel setting

Cnet I/F module is available to define driver type for P2P service about each channel. However, active mode in the standard settings should be set as "Use P2P settings". P2P setting according to active mode is as follows.

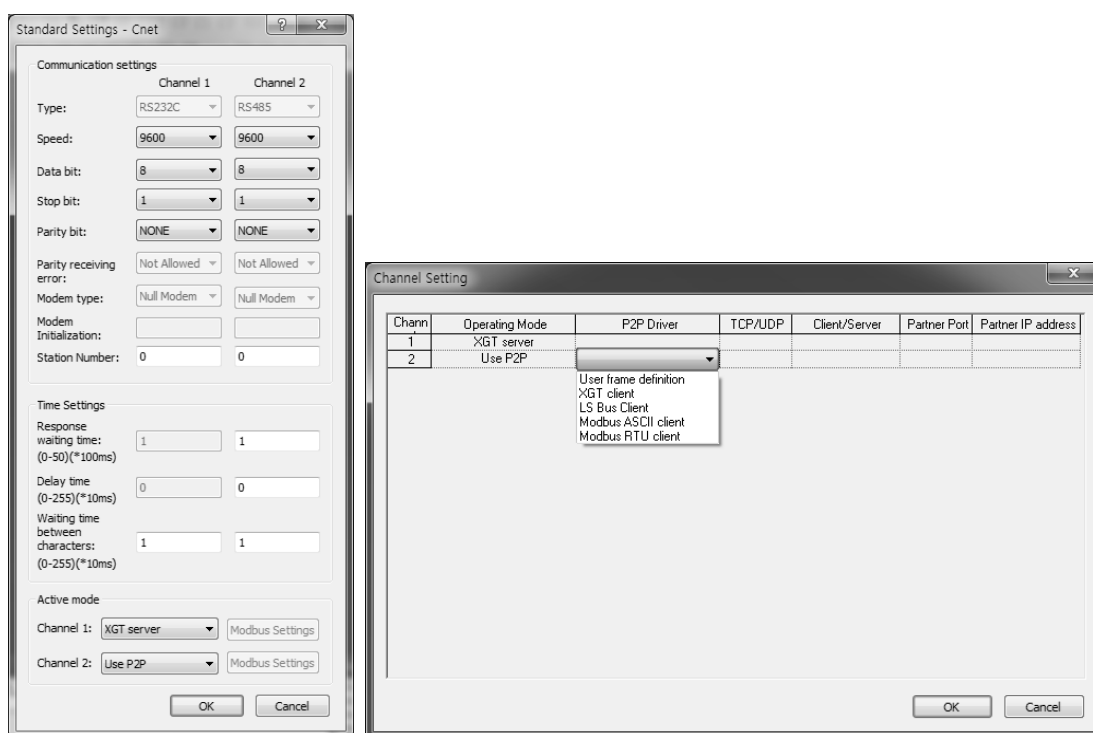



#### 2) P2P block setting

If selecting P2P block in the P2P parameter setting window, P2P block setting window shows.

Block setting window is same according to protocol and activated area is different P2P. Each of items means as follow.

Index	Ch	Driver Setting	P2P function	Conditional flag	Command type	Data type	No. of variables	Data size	Destination station	Destination station number	Frame	Setting
0	2	LS Bus Client			Continuous	wDRD	1		<input checked="" type="checkbox"/>	0		Setting
	①		②	③				④	⑤	⑥		⑦

No.	Type	Block form	Contents
1	Channel		Driver name changes according to driver set in the P2P Driver.
2	P2P function		1. Read : when reading the destination station's memory 2. Write: when writing self-station's memory to destination station's memory.
3	Conditional flag		1. Determines when Cnet sends request frame 2. In case of XBC type Ex. : F90(20ms flag), M01 3. In case of XEC type Ex. : _T20MS(20ms flag), %MX01

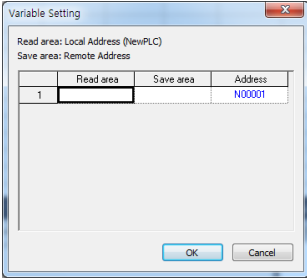
No.	Type	Block form	Contents
4	Data size		<ol style="list-style-type: none"> <li>This is activated when command type is continuous.</li> <li>When data type is 1 word, available max. no. is 8 word</li> </ol>
5	Destination station		<ol style="list-style-type: none"> <li>Check: Specify the destination station</li> </ol>
6	Destination station number		<ol style="list-style-type: none"> <li>Destination station number, setting range is 0~63.</li> </ol>
7	Setting		<ol style="list-style-type: none"> <li>When P2P function is Read               <ol style="list-style-type: none"> <li>Read area : device area of server</li> <li>Save area : client's device to save the data from server</li> </ol> </li> <li>When P2P function is Write               <ol style="list-style-type: none"> <li>Read area : device area of client</li> <li>Save area : Server's device area to save client's data</li> </ol> </li> </ol>

### 3) Writing parameter

After P2P block setting is completed, download setting parameter to CPU.

Select [Online] – [Connect] – [Write], and click OK in parameter download window, and then it will be downloaded.

After download, the parameter is applied immediately. If you check 'Set up with Link Enable', Link Enable can be applied with writing P2P/HS parameters at the same time.

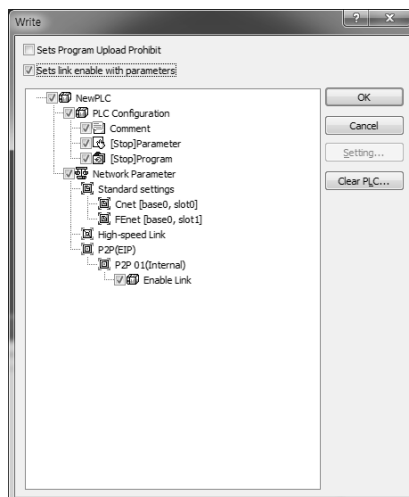

### 4) Enabling link

After setting P2P parameter and downloading the parameter to PLC CPU, enable P2P service. If parameter is downloaded but P2P(EIP) is not enabled, the P2P block is not operated. In order to enable P2P(EIP), Select [Online] – [Communication module setting] – [Enable Link], and click P2P(EIP) number which you want to operate and then click Write button. The P2P(EIP) is enabled.

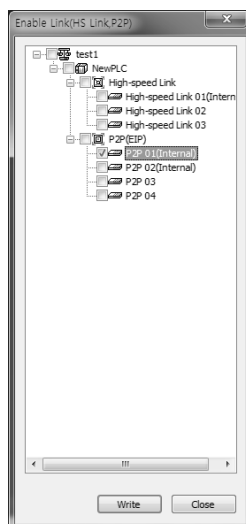

### 5) Diagnosis service

In order to check the setting parameter operates normally, diagnosis service is available.

Select [Online] – [Communication module setting] – [System Diagnosis]. Click the module and then click mouse right-button. If you select Frame Monitor or Status by Service, it can be checked whether the communication is normal or not. For more detail, refer to chapter 2.9 Diagnosis Function.

## 2.6 XGT Dedicated Protocol

XGT series dedicated protocol communication is function executing communication by our dedicated protocol. User can configure the intended communication system between our products without special setting by using reading/writing data of internal device area and monitoring function.

Dedicated protocol function supported by XGB is as follows.

- Device individual/continuous read
- Device individual/continuous write
- Monitor variable registration
- Monitor execution
- 1:1 connection (Our link) system configuration

**Note**

- XGB's built-in communication function supports Cnet communication without any separate Cnet I/F module. It must be used under the following instructions.
- Channel 1 of XGB's main unit supports 1:1 communication only. For 1:N system having master-slave Format, use RS-485 communication in channel 2 or XGB's main unit with XGL-C41A module connected. XGL-C41A module supports RS-422/485 protocol.
- RS-232C communication cable for XGB's main unit is different from RS-232C cable for XG5000 (XG-PD) in pin arrangement and from the cable for Cnet I/F module, too. The cable can't be used without any treatment. For the detailed wiring method, refer to configuration of respective communication.
- It's possible to set baud rate type and station No. in XG5000 (XG-PD).

### 2.6.1 XGT Dedicated Protocol

#### 1) Frame structure

##### (1) Basic format

##### a) Request frame (external communication device → XGB)

Header (ENQ)	Station number	Command	Command type	Structurized data area	Tail (EOT)	Frame check (BCC)
-----------------	-------------------	---------	-----------------	------------------------	---------------	----------------------

##### b) ACK response frame (XGB → external communication device, when receiving data normally)

Header (ACK)	Station number	Command	Command type	Structurized data area or Null code	Tail (ETX)	Frame check (BCC)
-----------------	-------------------	---------	-----------------	--	---------------	----------------------

##### c) NAK response frame (XGB → Cnet I/F module → external communication device when receiving data abnormally)

Header (NAK)	Station number	Command	Command type	Error code ( ASCII 4 Byte )	Tail (ETX)	Frame check (BCC)
-----------------	-------------------	---------	-----------------	-----------------------------	---------------	----------------------

### Note

- 1) The numerical data of all frames are ASCII codes equal to hexadecimal value, if there's no clear statement. The terms in hexadecimal are as follows.
  - Station No.
  - When the main command is R(r) or W (w) and the command type is numerical (means a data type)
  - All of the terms indicating size of all data in the Formatted data area.
  - Monitoring registration and command registration number of execution commands.
  - All contents of data
- 2) If it is hexadecimal, H is attached in front of the number of frames like H01, H12345, H34, H12, and H89AB.
- 3) Available frame length is maximum 256 bytes.
- 4) Used control codes are as follows.

Codes	Hex value	Name	Contents
ENQ	H05	Enquire	Request frame initial code
ACK	H06	Acknowledge	ACK response frame initial code
NAK	H15	Not Acknowledge	NAK response frame initial code
EOT	H04	End of Text	Request frame ending ASCII code
ETX	H03	End Text	Response frame ending ASCII code

- 5) If the command is small letter (r), BCC value is added in check frame. The other side capital letter (R), BCC value is not added in check frame.

### (2) Command frame sequence

#### a) Sequence of command request frame

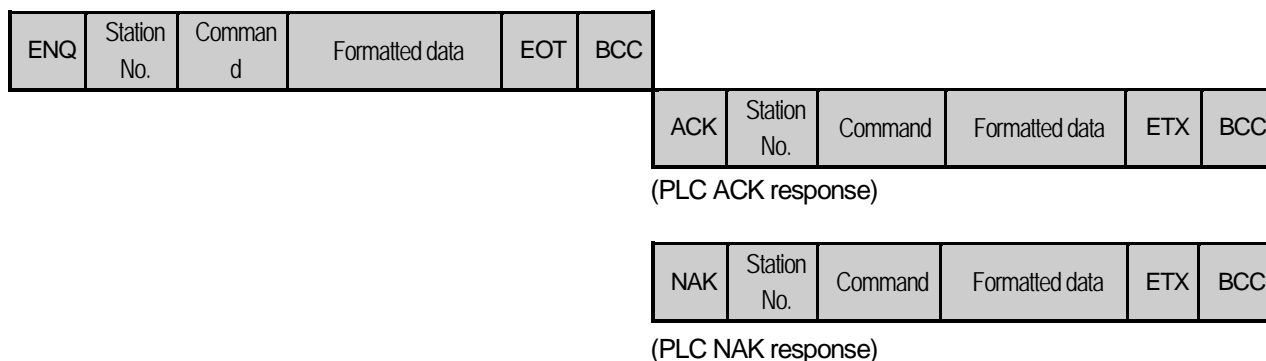

b) List of commands

List of commands used in dedication communication is as shown below.

Classification Items		Command				Treatment
		Main command		Command type		
		Code	ASCII code	Code	ASCII code	
Reading device	Individual	r(R)	H72 (H52)	SS	5353	Reads direct variable of Bit, Byte, Word, Dword, Lword type.
	Continuous	r(R)	H72 (H52)	SB	5342	Read direct variable of Byte, Word, Dword, Lword with block unit (Bit continuous read is not allowed)
Writing device	Individual	w(W)	H77 (H57)	SS	5353	Write data of Bit, Byte, Word, Dword, Lword at direct variable
	Continuous	w(W)	H77 (H57)	SB	5342	Write data of Byte, Word, Dword, Lword at direct variable with block unit (Bit continuous read is not allowed)

Classification Item		Command			Treatment
		Main command		Register No	
		Code	ASCII code		
Monitoring variable register	x(X)	H78 (H58)	H00~H0F		Register device to monitor.
Execution of monitoring	y(Y)	H79 (H59)	H00~H0F		Execute registered device to monitor.

**Note**

- It identifies capitals or small letters for main commands, but not for the others.

## Chapter 2 Built-in Cnet communication

### (3) Data type

It's possible to read and write device in built-in communication. When device is used, be aware of data type.

#### a) Available types of device (XBC type)

Device	Range	Size (Word)	Remark
P	P0 – P2047	2048	Read/Write/Monitor available
M	M0 – M2047	2048	Read/Write/Monitor available
K	K0 – K8191	8192	Read/Write/Monitor available
F	F0 – F2047	2048	Read/Monitor available
T	T0 – T2047	2048	Read/Write/Monitor available
C	C0 – C2047	2048	Read/Write/Monitor available
L	L0 – L4095	4096	Read/Write/Monitor available
N	N0 – N10239	10240	Read/Monitor available
D	D0 – D19999	20000	Read/Write/Monitor available
U	U00.00 – U0B.31	384	Read/Write/Monitor available
Z	Z0 – Z127	128	Read/Write/Monitor available
R	R0 – R16383	16384	Read/Write/Monitor available

#### b) Available types of device (XEC type)

Device	Range	Size (Word)	Remark
I	%IW0.0.0 ~ %IW15.15.3	1024	Read/Write/Monitor available
Q	%QW0.0.0 ~ %QW15.15.3	1024	Read/Write/Monitor available
M	%MW0 ~ %MW16383	16384	Read/Write/Monitor available
W	%WW0 ~ %WW32767	32768	Read/Monitor available
R	%RW0 ~ %RW16383	16384	Read/Write/Monitor available

When device is designated, attach '%' (25H) in front of the marking characters.

('%' is stands for starting of device.)

Data type	Marking characters	Examples
Bit	X(58h)	%PX000,%MX000,%LX000,%KX000,%CX000,%TX000,%FX000, %IX0.0.0,%QX0.0.0,%UX00.00.0, etc
Byte	B(42h)	%PB000,%MB000,%LB000,%KB000,%CB000,%TB000,%FB000, %IB0.0.0,%QB0.0.0, etc
Word	W(57h)	%PW000,%MW000,%LW000,%KW000,%CW000,%TW000,%FW000, %DW000,%IW0.0.0,%QW0.0.0,%MW0,%RW0,%WW0,%UW00.00, etc
Dword	D(44h)	%PD000,%MD000,%LD000,%KD000,%CD000,%TD000, %FD000,%DD000,%ID0.0.0,%QD0.0.0,%MD0,%RD0,%WD0, etc
Lword	L(4Ch)	%PL000,%ML000,%LL000,%KL000,%CL000,%TL000, %FL000,%DL000,%IL0.0.0,%QL0.0.0,%ML0,%RL0,%WL0, etc



**Note**

- In case of U device, it will be available only for operation as server.
- Timer/Counter used in bit command means contact point values.  
(word command means current values.)
- Data register (D) can use only word or byte commands.
- In byte type commands, address is doubled. For example, D1234 is addressed to '%DW1234' in word type, and is addressed to '%DB2468' in byte type.

## (4) Error codes

Error code is displayed as hex 2 byte (4 byte as ASCII code). The user can see error by frame monitor and in case of viewing by ASCII, the user can see the following error code.

Error code	Error type	Error details and causes	Example
0003	Number of blocks exceeded	Number of blocks exceeds 16 at Individual Read/Write Request	01rSS1105%MW10...
0004	Variable length error	Variable Length exceeds the max. size of 16	01rSS010D%MW100000000000 ..
0007	Data type error	Other data type than X,B,W,D,L received	01rSS0105%MK10
0011	Data error	Data length area information incorrect	01rSB05%MW10%4
		In case % is unavailable to start with	01rSS0105\$MW10
		Variable's area value wrong	01rSS0105%MW^&
		Other value is written for Bit Write than 00 or 01	01wSS0105%MX1011
0090	Monitor execution error	Unregistered monitor execution requested	
0190	Monitor execution error	Reg. No. range exceeded	
0290	Monitor reg. Error	Reg. No. range exceeded	
1132	Device memory error	Other letter than applicable device is input	
1232	Data size error	Request exceeds the max range of 60 Words to read or write at a time.	01wSB05%MW1040AA5512,..
1234	Extra frame error	Unnecessary details exist as added.	01rSS0105%MW10000
1332	Data type discordant	All the blocks shall be requested of the identical data type in the case of Individual Read/Write	01rSS0205%MW1005%MB10
1432	Data value error	Data value unavailable to convert to Hex	01wSS0105%MW10AA%5
7132	Variable request area exceeded	Request exceeds the area each device supports.	01rSS0108%MWFFFFFF

## 2.6.2 Detail of instruction

### 1) Individual reading of device (R(r)SS)

This is a function that reads PLC device specified in accord with memory data type. Separate device memory can be read up to 16 at a time.

● PC request format

Format name	Header	Station No.	Command	Command type	Number of blocks	Device length	Device name	.....	Tail	Frame check
Ex. of frame	ENQ	H20	R(r)	SS	H01	H06	%MW100		EOT	BCC
ASCII value	H05	H3230	H52(72)	H5353	H3031	H3036	H254D57313030		H04	

1 block (setting can be repeated up to max. 16 blocks)

Item	Description
BCC	When command is lowercase(r), only one lower byte of the value resulted by adding 1 Byte each to ASCII values from ENQ to EOT is converted into ASCII and added to BCC. For example, the BCC of the above frame is gotten as below: $H05+H32+H30+H72+H53+H53+H30+H31+H30+H36+H25+H4D+H57+H31+H30+H30+H04 = H03A4$ Therefore BCC value is A4 (ASCII value : H4134).
Number of Blocks	This specifies how much of the blocks composed of "[device length][device name]" are in this request format. This can be set up to 16. Therefore, the value of [Number of blocks] must be set between H01(ASCII value:3031)-H10(ASCII value:3030).
Device length (Length of device name)	This indicates the number of name's characters that means device, which is allowable up to 16 characters. This value is one of ASCII converted from hex type, and the range is from H01(ASCII value:3031) to H10(ASCII value:3130). For example, if the device name is %MW0, it has 4 characters to be H04 as its length. If %MW000 characters to be H06.
Device name	Address to be actually read is entered. This must be ASCII value within 16 characters, and in this name, digits, upper/lower case, '%' is only allowable to be entered.

**Note**

- BCC value is low 1byte in the sum of each byte from ENQ to EOT.
- In case of making actual frame, 'H' is not attached. Because the number data of frame indicates hexadecimal.

● XGB response format (ACK response)

Format name	Header	Station No.	Command	Command type	Number of blocks	Number of data	data	.....	Tail	Frame check
Ex. of frame	ACK	H20	R(r)	SS	H01	H02	HA9F3		ETX	BCC
ASCII value	H06	H3230	H52(72)	H5353	H3031	H3032	H41394633		H04	

1 block (max. 16 blocks possible)

Item	Description												
BCC	When command is lowercase(r), only one lower byte of the value resulted by adding 1 Byte each to ASCII values from ACK to ETX is converted into ASCII and added to BCC, and sent.												
Number of data	<p>Number of data means byte number of hex type, and is converted into ASCII. This number is determined according to data type (X,B,W) included in device name of computer request Format.</p> <ul style="list-style-type: none"> <li>Number of data in accordance with its data type is as follows:</li> </ul> <table border="1" style="margin-left: 40px;"> <thead> <tr> <th>Data type</th> <th>Available variable</th> <th>Number of data</th> </tr> </thead> <tbody> <tr> <td>Bit(X)</td> <td>%(P,M,L,K,F,T,C,D,R,I,Q,W)X</td> <td>1</td> </tr> <tr> <td>Byte(B)</td> <td>%(P,M,L,K,F,T,C,D,R,I,Q,W)B</td> <td>1</td> </tr> <tr> <td>Word(W)</td> <td>%(P,M,L,K,F,T,C,D,R,I,Q,W)W</td> <td>2</td> </tr> </tbody> </table> <p>※R area is supported at XBC-DXXXU</p>	Data type	Available variable	Number of data	Bit(X)	%(P,M,L,K,F,T,C,D,R,I,Q,W)X	1	Byte(B)	%(P,M,L,K,F,T,C,D,R,I,Q,W)B	1	Word(W)	%(P,M,L,K,F,T,C,D,R,I,Q,W)W	2
Data type	Available variable	Number of data											
Bit(X)	%(P,M,L,K,F,T,C,D,R,I,Q,W)X	1											
Byte(B)	%(P,M,L,K,F,T,C,D,R,I,Q,W)B	1											
Word(W)	%(P,M,L,K,F,T,C,D,R,I,Q,W)W	2											
Data	<ul style="list-style-type: none"> <li>In data area, there are the values of hex data converted to ASCII code saved.</li> </ul>												

▪Example 1

The fact that number of data is H04 (ASCII code value:H3034) means that there is hex data of 4 bytes in data. Hex data of 4 bytes is converted into ASCII code in data.

▪Example 2

If number of data is H04 and the data is H12345678, ASCII code converted value of this is "31 32 33 34 35 36 37 38," and this contents is entered in data area. Name directly, highest value is entered first, lowest value last.

**Note**

- If data type is Bit, data read is indicated by bytes of hex. Namely, if Bit value is 0, it indicated by H00, and if 1, by H01.



● PC request format (PC → XGB)

Format name	Header	Station No.	Command	Command type	Number of blocks	Variable length	Variable name	Device length	Variable name	Tail	Frame check
Ex. of frame	ENQ	H01	R(r)	SS	H02	H06	%MW020	H06	%PW001	EOT	BCC
ASCII value	H05	H3031	H52(72)	H5353	H3032	H3036	H254D57303230	H3036	H25505730303031	H04	

● For ACK response after execution of command (PC ← XGB)

Format name	Header	Station No.	Command	Command type	Number of blocks	Number of data	Data	Number of data	Data	Tail	Frame check
Ex. of frame	ACK	H01	R(r)	SS	H02	H02	H1234	H02	H5678	ETX	BCC
ASCII value	H06	H3031	H52(72)	H5353	H3032	H3032	H31323334	H3032	H35363738	H03	

● For NAK response after execution of command (PC ← XGB)

Format name	Header	Station No.	Command	Command type	Error code	Tail	Frame check
Ex. of frame	NAK	H01	R(r)	SS	Error code (2 Byte)	ETX	BCC
ASCII value	H15	H3031	H52(72)	H5353	Error code (4 Byte)	H03	

### 1) Direct variable continuous reading (R(r)SB)

This is a function that reads the PLC device memory directly specified in accord with memory data type. With this, data is read from specified address as much as specified continuously.

- PC request format

Format name	Header	Station No.	Command	Command type	Device length	Device	Number of data	Tail	Frame check
Ex. of frame	ENQ	H10	R(r)	SB	H06	%MW100	H05	EOT	BCC
ASCII value	H05	H3130	H52(72)	H5342	H3036	H254D5731 3030	H3035	H04	

#### Note

- Number of data specifies the number to read according to the type of data. Namely, if the data type of device is word and number is 5, it means that 5 words should be read.
- In the number of data, you can use up to 60 words (120Byte).
- Protocol of continuous reading of direct variable doesn't have number of blocks.
- Bit device continuous reading is not supported.

Item	Description
BCC	When command is lowercase(r), only one lower byte of the value resulted by adding 1 Byte each to ASCII values from ENQ to EOT is converted into ASCII and added to BCC.
Device length (Length of device name)	This indicates the number of name's characters that means device, which is allowable up to 16 characters. This value is one of ASCII converted from hex type, and the range is from H01 (ASCII value:3031) to H10 (ASCII value:3130).
Device name	Address to be actually read is entered. This must be ASCII value within 16 characters, and in this name, digits, upper/lowercase, and '%' only are allowable to be entered.

● XGB response format (ACK response)

Format name	Header	Station No.	Command	Command type	Number of blocks	Number of data	data	Tail	Frame check
Ex. of frame	ACK	H10	R(r)	SB	H01	H02	H1122	ETX	BCC
ASCII value	H06	H3130	H52(72)	H5342	H3031	H3134	H31313232	H03	

Item	Description															
Number of data	It means byte number of hex type, and is converted into ASCII															
	<table border="1"> <thead> <tr> <th>Data type</th> <th>Available device</th> <th>Data size (Byte)</th> </tr> </thead> <tbody> <tr> <td>BYTE(B)</td> <td>%(P,M,L,K,F,T,C,D,R,I,Q,W)B</td> <td>1</td> </tr> <tr> <td>WORD(W)</td> <td>%(P,M,L,K,F,T,C,D,R,I,Q,W)W</td> <td>2</td> </tr> <tr> <td>DWord(D)</td> <td>%(P,M,L,K,F,T,C,D,R,I,Q,W)D</td> <td>4</td> </tr> <tr> <td>LWord(L)</td> <td>%(P,M,L,K,F,T,C,D,I,Q,W)L</td> <td>8</td> </tr> </tbody> </table>	Data type	Available device	Data size (Byte)	BYTE(B)	%(P,M,L,K,F,T,C,D,R,I,Q,W)B	1	WORD(W)	%(P,M,L,K,F,T,C,D,R,I,Q,W)W	2	DWord(D)	%(P,M,L,K,F,T,C,D,R,I,Q,W)D	4	LWord(L)	%(P,M,L,K,F,T,C,D,I,Q,W)L	8
	Data type	Available device	Data size (Byte)													
	BYTE(B)	%(P,M,L,K,F,T,C,D,R,I,Q,W)B	1													
	WORD(W)	%(P,M,L,K,F,T,C,D,R,I,Q,W)W	2													
DWord(D)	%(P,M,L,K,F,T,C,D,R,I,Q,W)D	4														
LWord(L)	%(P,M,L,K,F,T,C,D,I,Q,W)L	8														
※R area is supported at XBC-DXXXU																

▪Example 1

When memory type included in variable name of computer request Format is W (Word), and data number of computer request Format is 03, data number of PLC ACK response after execution of command is indicated by H06 (2\*03 = 06 bytes)Byte and ASCII code value 3036 is entered in data area.

▪Example 2

In just above example, when data contents of 3 words are 1234, 5678, and 9ABC in order, actual ASCII code converted values are 31323334 35363738 39414243, and the contents are entered in data area.

● XGB response format (NAK response)

Format name	Header	Station No.	Command	Command type	Error code (Hex 2 Byte)	Tail	Frame check
Ex. of frame	NAK	H10	R(r)	SB	H1132	ETX	BCC
ASCII value	H15	H3130	H52(72)	H5342	H31313332	H03	

Item	Description
BCC	When command is lowercase(r), only one lower byte of the value resulted by adding 1 Byte each to ASCII values from NAK to ETX is converted into ASCII and added to BCC, and sent.
Error code	Hex and 2 bytes (ASCII code, 4 bytes) indicate error type. For the details, Refer to XGT dedicated communication error codes and countermeasures.

## Chapter 2 Built-in Cnet communication

- Example

This example supposes that 2 WORDs from M000 of station No. 10 is read  
(It supposes that M000 = H1234, M001 = H5678.)

- PC request format (PC → XGB)

Format name	Header	Station No.	Command	Command type	Device length	Device name	Number of data	Tail	Frame check
Frame (Example)	ENQ	H0A	R(r)	SB	H06	%MW000	H02	EOT	BCC
ASCII value	H05	H3041	H52(72)	H5342	H3036	H254D3030 30	H3032	H04	

- For ACK response after execution of command (PC ← XGB)

Format name	Header	Station No.	Command	Command type	Number of block	Number of data	Data	Tail	Frame check
Frame (Example)	ACK	H0A	R(r)	SB	H01	H04	12345678	ETX	BCC
ASCII value	H06	H3041	H52(72)	H5342	H3031	H3034	H3132333435363738	03	

- For NAK response after execution of command (PC ← XGB)

Format name	Header	Station No.	Command	Command type	Error code	Tail	BCC
Frame (Example)	NAK	H0A	R(r)	SB	Error code (2 Byte)	ETX	BCC
ASCII value	H15	H3041	H52(72)	H5342	Error code (4 Byte)	H03	



2) Individual writing of device (W(w)SS)

This is a function that writes the PLC device memory directly specified in accord with memory data type.

● PC request format

Format name	Header	Station No.	Command	Command type	Number of blocks	Device Length	Device Name	Data	.....	Tail	Frame check
Frame(Example)	ENQ	H20	W(w)	SS	H01	H06	%MW100	H00E2		EOT	BCC
ASCII value	H05	H3230	H57(77)	H5353	H3031	H3036	H254D573130 30	H30304532		H04	

1 block (setting can be repeated up to max. 16 blocks)

Item	Description
BCC	When command is lowercase(r), only one lower byte of the value resulted by adding 1 Byte each to ASCII values from ENQ to EOT is converted into ASCII and added to BCC.
Number of blocks	This specifies how much of the blocks composed of "[device length][device name]" are in this request Format. This can be set up to 16. Therefore, the value of [Number of blocks] must be set between H01(ASCII value:3031)-H10 (ASCII value:3030).
Device Length (Name length of device)	This indicates the number of name's characters that means device, which is allowable up to 16 characters. This value is one of ASCII converted from hex type, and the range is from H01 (ASCII value: 3031) to H10 (ASCII value:3130).
device	Address to be actually read is entered. This must be ASCII value within 16 characters, and in this name, digits, upper/lower case, and '%' only is allowable to be entered.
Data	If the value to be written in %MW100 area is H A, the data Format must be H000A. If the value to be written in %MW100 area is H A, the data Format must be H000A. In data area, the ASCII value converted from hex data is entered.

▪Example 1

If type of data to be currently written is WORD, the data is H1234, ASCII code converted value of this is "31323334" and this content must be entered in data area. Namely, most significant value must be sent first, least significant value last.

Note

- Device data types of each block must be the same
- If data type is Bit, the data to be written is indicated by bytes of hex. Namely, if Bit value is 0, it must be indicated by H00 (3030), and if 1, by H01 (3031).

## Chapter 2 Built-in Cnet communication

- XGB Response format (ACK response)

Format name	Header	Station No.	Command	Command type	Tail	Frame check
Frame (Example)	ACK	H20	W(w)	SS	ETX	BCC
ASCII value	H06	H3230	H57(77)	H5353	H03	

Item	Description
BCC	When command is lowercase (r), only one lower byte of the value resulted by adding 1 Byte each to ASCII values from ACK to ETX is converted into ASCII and added to BCC, and sent.

- XGB Response format (NAK response)

Format name	Header	Station No.	Command	Command type	Error code (Hex 2 Byte)	Tail	Frame check
Frame (Example)	NAK	H20	W(w)	SS	H4252	ETX	BCC
ASCII value	H15	H3230	H57(77)	H5353	H34323532	H03	

Item	Description
BCC	When command is lowercase(r), only one lower byte of the value resulted by adding 1 Byte each to ASCII values from NAK to ETX is converted into ASCII and added to BCC, and sent.
Error code	Hex and 2 bytes (ASCII code, 4 bytes) indicate error type. For the details, Refer to 10.1.4 XGT dedicated communication error codes and countermeasures.

- Example

This example supposes that "HFF" is written in M230 of station No. 1.

1) PC request format (PC → XGB)

Format name	Header	Station No.	Command	Command type	Number of blocks	Device Length	Device Name	Data	Tail	Frame check
Frame (Example)	ENQ	H01	W(w)	SS	H01	H06	%MW230	H00FF	EOT	BCC
ASCII value	H05	H3031	H57(77)	H5353	H3031	H3036	H254D573233 30	H30304646	H04	

2) For ACK response after execution of command (PC ← XGB)

Format name	Header	Station No.	Command	Command type	Tail	Frame check
Frame (Example)	ACK	H01	W(w)	SS	ETX	BCC
ASCII value	H06	H3031	H57(77)	H5353	H03	

3) For NAK response after execution of command (PC ← XGB)

Format name	Header	Station No.	Command	Command type	Error code	Tail	Frame check
Frame (Example)	NAK	H01	W(w)	SS	Error code (2 Byte)	ETX	BCC
ASCII value	H15	H3031	H57(77)	H5353	Error code (4 Byte)	H03	

### 3) Continuous writing of device (W(w)SB)

This is a function that directly specifies PLC device memory and continuously writes data from specified address as much as specified length.

● Request format

Format name	Header	Station No.	Command	Command type	Device Length	Device name	Number of data	Data	Tail	Frame check
Frame (Example)	ENQ	H10	W(w)	SB	H06	%MW100	H02	H11112222	EOT	BCC
ASCII value	H05	H3130	H57(77)	H5342	H3036	H254D57313030	H3032	H3131313132323232	H04	

Note
<ul style="list-style-type: none"> <li>• Number of data specifies the number according to the type of device. Namely, if the data type of device is WORD, and number of data is 5, it means that 5 WORDs should be written.</li> <li>• Number of data can be used up to 120Bytes (60 Words).</li> </ul>

Item	Description
BCC	When command is lowercase(r), only one lower byte of the value resulted by adding 1 Byte each to ASCII values from ENQ to EOT is converted into ASCII and added to BCC.
Device Length (Name length of variable)	This indicates the number of name's characters that means device, which is allowable up to 16 characters. This value is one of ASCII converted from hex type, and the range is from H01 (ASCII value: 3031) to H10 (ASCII value: 3130).
Device	Address to be actually read. This must be ASCII value within 16 characters, and in this name, digits, upper/lower case, and '%' only are allowable to be entered.

● XGB Response format (ACK response)

Format name	Header	Station No.	Command	Command type	Tail	Frame check
Frame (Example)	ACK	H10	W(w)	SB	ETX	BCC
ASCII value	H06	H3130	H57(77)	H5342	H03	

Item	Description
BCC	When command is lowercase(r), only one lower byte of the value resulted by adding 1 Byte each to ASCII values from ACK to ETX is converted into ASCII and added to BCC, and sent.

## Chapter 2 Built-in Cnet communication

- XGB Response format (NAK response)

Format name	Header	Station No.	Command	Command type	Error code (Hex 2 Byte)	Tail	Frame check
Frame (Example)	ENQ	H10	W(w)	SB	H1132	EOT	BCC
ASCII value	H05	H3130	H57(77)	H5342	H31313332	H03	

Item	Description
BCC	When command is lowercase(r), only one lower byte of the value resulted by adding 1 Byte each to ASCII values from NAK to ETX is converted into ASCII and added to BCC, and sent.
Error code	Hex and 2 bytes (ASCII code, 4 bytes) indicate error type. For the details, Refer to XGT dedicated communication error codes and countermeasures.

- Example

This example supposes that 2 byte H'AA15 is written in D000 of station No. 1.

1) PC request format (PC → XGB)

Format name	Header	Station No.	Command	Command type	Device Length	Device	Number of data	Data	Tail	Frame check
Frame (Example)	ENQ	H01	W(w)	SB	H06	%DW000	H01	HAA15	EOT	BCC
ASCII value	H05	H3031	H57(77)	H5342	H3036	H254457303030	H3031	H41413135	H04	

2) For ACK response after execution of command (PC ← XGB)

Format name	Header	Station No.	Command	Command type	Tail	Frame check
Frame (Example)	ACK	H01	W(w)	SB	ETX	BCC
ASCII value	H06	H3031	H57(77)	H5342	H03	

3) For NAK response after execution of command (PC ← XGB)

Format name	Header	Station No.	Command	Command type	Error code	Tail	Frame check
Frame (Example)	NAK	01	W(w)	SB	Error code (2)	ETX	BCC
ASCII value	H15	H3031	H57(77)	H5342	Error code (4)	H03	

4) Monitor variable register (X##)

Monitor register can separately register up to 16 (from 0 to 15) in combination with actual variable reading command, and carries out the registered one through monitor command after registration.

● PC request format

Format name	Header	Station No.	Command	Registration No.	Registration format	Tail	Frame check
Frame (Example)	ENQ	H10	X(x)	H09	Refer to registration format	EOT	BCC
ASCII value	H05	H3130	H58(78)	H3039	Refer to *1	H04	

Item	Description
BCC	When command is lowercase(x), only one lower byte of the value resulted by adding 1 byte each to ASCII values from ENQ to EOT is converted into ASCII, added to BCC.
Register No.	This can be registered up to 16 (0 to 15, H00-H0F), and if an already registered No. is registered again, the one currently being executed is registered.
Register Format	This is used to before EOT in command of Formats of separate reading of variable, continuous reading, and named variable reading.

\*1 : Register Format of request Formats must select and use only one of the followings.

1) Individual reading of device

RSS	Number of blocks (2 Byte)	Device length (2 Byte)	Device name (16 Byte)	...
	1 block (max. 16 blocks)			

2) Continuous reading of device

RSB	Device length (2 Byte)	Device name (16 Byte)	Number of data
-----	------------------------	-----------------------	----------------

● XGB Response format (ACK response)

Format name	Header	Station No.	Command	Registration no.	Tail	Frame check
Frame (Example)	ACK	H10	X(x)	H09	ETX	BCC
ASCII value	H06	H3130	H58(78)	H3039	H03	

Item	Description
BCC	When command is lowercase(x), only one lower byte of the value resulted by adding 1 Byte each to ASCII values from ACK to ETX is converted into ASCII and added to BCC, and sent.

## Chapter 2 Built-in Cnet communication

- XGB Response format (NAK response)

Format name	Header	Station No.	Command	Registration No.	Error code (Hex 2Byte)	Tail	Frame check
Frame(Example)	NAK	H10	X(x)	H09	H1132	ETX	BCC
ASCII value	H15	H3130	H58(78)	H3039	H31313332	H03	

Item	Description
BCC	When command is one of lower case(x), only one lower byte of the value resulted by adding 1 Byte each to ASCII values from NAK to ETX is converted into ASCII and added to BCC, and sent.
Error code	Hex and 2 bytes (ASCII code, 4 bytes) indicate error type. For the details, Refer to XGT dedicated communication error codes and countermeasures.

- Example

This example supposes that device M000 of station NO. 1 is monitor registered.

1) PC request format (PC → XGB)

Format name	Header	Station No.	Command	Registration No.	Registration Format				Tail	Frame check
					R##	Number of blocks	Device length	Device name		
Frame(Example)	ENQ	H01	X(x)	H01	RSS	H01	H06	%MW000	EOT	BCC
ASCII value	H05	H3031	H58(78)	H3031	H5253 53	H3031	H3036	H2554573030 30	H04	

2) For ACK response after execution of command (PC ← XGB)

Format name	Header	Station No.	Command	Registration No.	Tail	Frame check
Frame(Example)	ACK	H01	X(x)	H01	ETX	BCC
ASCII value	H06	H3031	H58(78)	H3031	H03	

3) For NAK response after execution of command (PC ← XGB)

Format name	Header	Station No.	Command	Registration No.	Error code	Tail	Frame check
Frame(Example)	NAK	H01	X(x)	H01	Error code (2)	ETX	BCC
ASCII value	H15	H3031	H58(78)	H3031	Error code (4)	H03	

5) Monitor execution (Y##)

This is a function that carries out the reading of the variable registered by monitor register. This also specifies a registered number and carries out reading of the variable registered by the number.

● PC request format

Format name	Header	Station No.	Command	Registration No.	Tail	Frame check
Frame (Example)	ENQ	H10	Y(y)	H09	EOT	BCC
ASCII value	H05	H3130	H59(79)	H3039	H03	

Item	Description
Register No.	Register No. uses the same number registered during monitor register for monitor execution. It is possible to set from 00-09 (H00-H09).
BCC	When command is lower case(y), only one lower byte of the value resulted by adding 1 byte each to ASCII values from ENQ to EOT is converted into ASCII, added to BCC.

● XGB Response format (ACK response)

1) In case that the register Format of register No. is the Individual reading of device

Format name	Header	Station No.	Command	Registration No.	Number of Blocks	Number of data	Data	Tail	Frame check
Frame (Example)	ACK	H10	Y(y)	H09	H01	H02	H9183	ETX	BCC
ASCII value	H06	H3130	H59(79)	H3039	H3031	H3032	H39313833	H03	

2) In case that the register Format of register No. is the continuous reading of device

Format name	Header	Station No.	Command	Registration No.	Number of data	Data	Tail	Frame check
Frame (Example)	ACK	H10	Y(y)	H09	H04	H9183AABB	ETX	BCC
ASCII value	H06	H3130	H59(79)	H3039	H3034	H393138334141424 2	H03	

● XGB Response Format (NAK response)

Format name	Header	Station No.	Command	Registration No.	Error code (Hex 2Byte)	Tail	Frame check
Frame (Example)	NAK	H10	Y(y)	H09	H1132	ETX	BCC
ASCII value	H15	H3130	H59(79)	H3039	H31313332	H03	

Item	Description
BCC	When command is lowercase(y), only one lower byte of the value resulted by adding 1 Byte each to ASCII values from NAK to ETX is converted into ASCII and added to BCC, and sent.
Error code	Hex and 2 bytes (ASCII code, 4 bytes) indicate error type. For the details, Refer to XGT dedicated communication error codes and countermeasures.

- Example

This example supposes that registered device No. 1 of station No. 1 is read, and BCC value is checked. And it is supposed that device M000 is registered and the number of blocks is 1.

1) PC request format (PC → XGB)

Format name	Header	Station No.	Command	Registration No.	Tail	Frame check
Frame (Example)	ENQ	H01	Y(y)	H01	EOT	BCC
ASCII value	H05	H3031	H59(79)	H3031	H04	

2) For ACK response after execution of command (PC → XGB)

Format name	Header	Station No.	Command	Registration No.	Number of Blocks	Number of data	Data	Tail	Frame check
Frame (Example)	ACK	H01	Y(y)	H01	H01	H02	H2342	ETX	BCC
ASCII value	H06	H3031	H59(79)	H3031	H3031	H3032	H32333432	H03	

3) For NAK response after execution of command (PC → XGB)

Format name	Header	Station No.	Command	Registration No.	Error code	Tail	Frame check
Frame (Example)	NAK	H01	Y(y)	H01	Error code(2)	ETX	BCC
ASCII value	H15	H3031	H59(79)	H3031	Error code(4)	H03	



## 2.7 LS Bus Protocol

LS Bus Protocol communication is function executing communication between XGB Cnet and LS Inverter. User can configure LS Bus communication system between our products without special setting by using reading/writing data of internal device area and monitoring function

### 2.7.1 LS Bus Protocol

LS Bus Protocol communication is function executing communication between XGB Cnet and LS Inverter. User can configure LS Bus communication system between our products without special setting by using reading/writing data of internal device area and monitoring function.

The function of LS Bus Protocol supported by XGB is as follows.

- ◆ Device continuous reading
- ◆ Device continuous writing

#### 1) Frame structure

(1) Base format

(a) Request frame (External communication → XGB)

Header (ENQ)	Station number	Command	Structurized data area	Frame check (BCC)	Tail (EOT)
--------------	----------------	---------	------------------------	-------------------	------------

(b) ACK response frame (XGB → External communication, when receiving data normally)

Header (ACK)	Station number	Command	Structurized data area	Frame check (BCC)	Tail (EOT)
--------------	----------------	---------	------------------------	-------------------	------------

(c) NAK response frame (XGB → External communication, when receiving data abnormally)

Header (NAK)	Station number	Command	Error code ( ASCII 4 Byte )	Frame check (BCC)	Tail (EOT)
--------------	----------------	---------	-----------------------------	-------------------	------------

#### Note

- 1) The numerical data of all frames are ASCII codes equal to hexadecimal value, if there's no clear statement. The terms in hexadecimal are as follows.
  - Station No.
  - Command type is supported R (read) and W (write).
  - All contents of data
- 2) If it is hexadecimal, H is attached in front of the number of frames like H01, H12345, H34, H12, and H89AB.
- 3) Available frame length is maximum 256 bytes.
- 4) Used control codes are as follows.

Code	Hex value	Name	Contents
ENQ	H05	Enquire	Request frame initial code
ACK	H06	Acknowledge	ACK response frame initial code
NAK	H15	Not Acknowledge	NAK response frame initial code
EOT	H04	End of Text	Request frame ending ASCII code

## Chapter 2 Built-in Cnet communication

### 2) Command frame sequence

#### (1) Sequence of command request frame

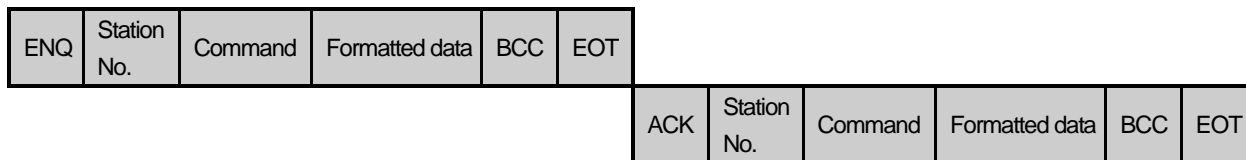

(Inverter ACK response)

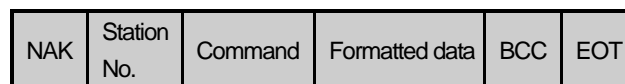

(Inverter NAK response)

#### (2) List of commands

List of commands used in LS Bus communication is as shown below.

Classification Items	Command		Treatment
	Command type		
	Code	ASCII code	
Continuous read	R	H52	Read inverter variable of Word.
Continuous write	W	H57	Write inverter variable of Word.

## 2.7.2 Detail of instruction

### 1) Continuous writing to inverter (W)

This command is to write PLC data in specified address of inverter.

- LS Bus Client Request format

Format name	Header	Station No.	Command	Device Length	Address of inverter	Data	.....	Frame check	Tail
Frame (Example)	ENQ	H20	W	H6	0100	H00E2	-	BCC	EOT
ASCII value	H05	H3230	H57	H36	H30313030	H30304532	-	-	H04

Item	Description
BCC	When ASCII value of each 1byte except ENQ and EOT is summed, the lowest 1byte of the result value is BCC.
Device Length	This specifies how many Words you will write. As converted value to ASCII, the range is from H01 (ASCII value: 3031) to H08 (ASCII value: 3038).
Address of inverter	Enter the address that you want to read. ASCII value above 4 characters and non-numeric is not allowed.
Data	When you write data H'A to inverter address 0100 area, the data format has to be H000A.

- Example)

If you want to write H1234, 31323334 (Converted value to ASCII) should be included in the data area. So, the highest value has to be sent first and the lowest value has to be sent last.

#### Note

- Device data of Word type is only supported.

## Chapter 2 Built-in Cnet communication

- Inverter Response format(ACK response)

Format name	Header	Station No.	Command	Data		Frame check	Tail
Frame (Example)	ACK	H20	W	H00E2	...	BCC	EOT
ASCII value	H06	H3230	H57	H30304532	-	-	H04

Item	Description
BCC	When ASCII value of each 1byte except ENQ and EOT is summed, the lowest 1byte of the result value is BCC.

- Inverter Response format(NAK response)

Format name	Header	Station No.	Command	Error code (ASC 2 Byte)	Frame check	Tail
Frame (Example)	NAK	H20	W	H12	BCC	EOT
ASCII value	H15	H3230	H57	H3132	-	H04

Item	Description
BCC	When ASCII value of each 1byte except ENQ and EOT is summed, the lowest 1byte of the result value is BCC.
Error code	Error information is shown as hex 1byte (2bytes of ASCII code). For more information, please refer to the error code of the inverter user manual.

- Example

This describes if the user want to write "H00FF" to address number 1230 of station number 1 of inverter.

- XGB request format (XGB → Inverter)

Format name	Header	Station No.	Command	Device length	Address of inverter	Data	Frame check	Tail
Frame (Example)	ENQ	H01	W	H1	1230	H00FF	BCC	EOT
ASCII value	H05	H3031	H57	H3031	H31323330	H30304646	-	H04

- For ACK response after execution of command (XGB ← Inverter)

Format name	Header	Station No.	Command	Data	Frame check	Tail
Frame (Example)	ACK	H01	W	H00FF	BCC	EOT
ASCII value	H06	H3031	H57	H30304646	-	H04

- For NAK response after execution of command (XGB ← Inverter)

Format name	Header	Station No.	Command	Error code	Frame check	Tail
Frame (Example)	NAK	H01	W	H12	BCC	EOT
ASCII value	H15	H3031	H57	Error code (2 Byte)	-	H04

## 2) Continuous reading from inverter (R)

This is a function of continuous reading of designated amount of PLC data from designated address number.

- PC Request format

Format name	Header	Station No.	Command	Address of inverter	Number of data	Frame check	Tail
Frame (Example)	ENQ	H10	R	0100	H5	BCC	EOT
ASCII value	H05	H3130	H52	H30313030	H35	-	H04

Item	Description
BCC	When ASCII value of each 1byte except ENQ and EOT is summed, the lowest 1byte of the result value is BCC.
Device length	This specifies how many Words you will write. As converted value to ASCII, the range is from H01 (ASCII value: 3031) to H08 (ASCII value: 3038).
Address of inverter	Enter the address that you want to read. ASCII value above 4 characters and non-numeric is not allowed.

**Note**

- Device data of Word type is only supported.

## Chapter 2 Built-in Cnet communication

- Inverter response format (ACK response)

Format name	Header	Station No.	Command	Data		Frame check	Tail
Frame (Example)	ACK	H20	R	H00E2	...	BCC	EOT
ASCII value	H06	H3230	H52	H30304532	-	-	H04

Item	Description
BCC	When ASCII value of each 1byte except ENQ and EOT is summed, the lowest 1byte of the result value is BCC.

- Inverter response format (NAK response)

Format name	Header	Station No.	Command	Error code (ASC 2 Byte)	Frame check	Tail
Frame (Example)	NAK	H20	R	H12	BCC	EOT
ASCII value	H15	H3230	H52	H3132	-	H04

Item	Description
BCC	When ASCII value of each 1byte except ENQ and EOT is summed, the lowest 1byte of the result value is BCC.
Error code	Error information is shown as hex 1byte (2bytes of ASCII code). For more information, please refer to the error code of the inverter user manual.

- Example

This describes if the user want to read 1Word data from address number 1230 of station number 1 of inverter..

- XGB request format (XGB → Inverter)

Format name	Header	Station No.	Command	Address of inverter	Device length	Frame check	Tail
Frame (Example)	ENQ	H01	R	1230	H1	BCC	EOT
ASCII value	H05	H3031	H52	H31323330	H31	-	H04

- For ACK response after execution of command (XGB ← Inverter)

Format name	Header	Station No.	Command	Data	Frame check	Tail
Frame (Example)	ACK	H01	R	H1234	BCC	EOT
ASCII value	H06	H3031	H52	H31323334	-	H04

- For NAK response after execution of command (XGB ← Inverter)

Format name	Header	Station No.	Command	Error code	Frame check	Tail
Frame (Example)	NAK	H01	R	H12	BCC	EOT
ASCII value	H15	H3031	H52	H3132	-	H04

## 2.8 Modbus Protocol

Modbus protocol is specified open protocol used between client-server, which executes reading/writing data according to function code. Communication between devices that use Modbus protocol uses Client-server function in which only one client processes the data.

### 2.8.1 Modbus Protocol

There are two communication modes of Modbus, ASCII and RTU.

Characteristic		ASCII mode	RTU mode
Coding method		ASCII code	8 bit binary code
No. of data per one character	Start bit	1	1
	Data bit	7	8
	Parity bit	Even,Odd,None	Even,Odd,None
	Stop bit	1 or 2	1 or 2
Error check		LRC(Longitudinal Redundancy Check)	CRC (Cyclical Redundancy Check)
Start of frame		Colon (:)	3.5 Character no response time

#### 1) Structure of Modbus protocol

Modbus protocol's structure is as follows.

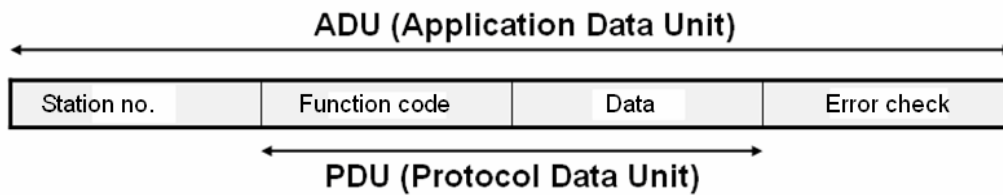

In case of normal communication, process step is as follows.

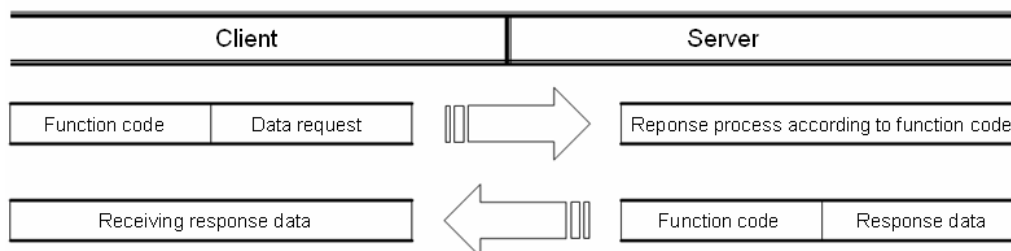

In case of abnormal communication, process step is as follows.

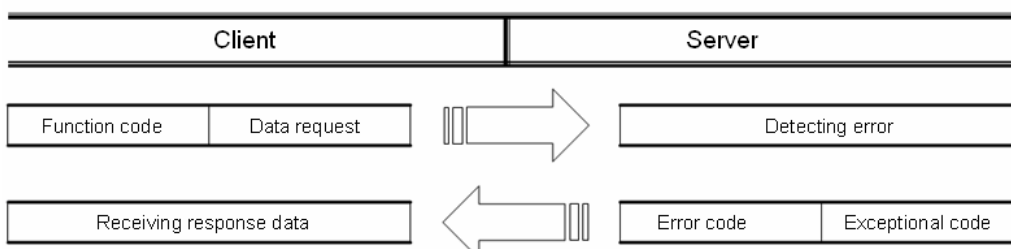

## Chapter 2 Built-in Cnet communication

When receiving the abnormal frame from client, server transmits error code and exceptional code. Error code is function code adding 80(Hex) and exceptional code indicate the specific error content. Each code has following content.

Code	Code name	Meaning
01	Function code error	Function code error
02	Address error	Exceeds allowed address range
03	Data setting error	Not allowed data value
04	Server error	Server(slave) is error
05	Server requesting re-transmission	Now server is too busy to process and requests re-transmission later
06	Server process time delay	Server takes time to process. Master should request again.

### 2.8.2 Frame Structure

#### 1) Frame structure in ASCII mode

Frame structure in the ASCII mode is as follows.

Classification	Start	Station no.	Function code	Data	Error check	End
Size (byte)	1	2	2	N	2	2

#### (1) Characteristic of ASCII mode

- a) In the ASCII mode, start of frame is indicated with colon (:), which is ASCII code, and end of frame is indicated with 'CRLF'.
- b) Each character allows maximum 1s interval.
- c) How to check the error uses LRC, it takes 2's complement except frame of start and end and converts it as ASCII conversion.

#### (2) Address area

- a) It consists of 2 byte.
- b) When using the XGT Cnet I/F module, range of station is 0~31.
- c) Station number 0 is used for client.
- d) When server responds, it contains self address to response frame to know client's response.

#### (3) Data area

- a) Transmits the data by using the ASCII data, data structure changes according to function code.
- b) In case of receiving normal frame, it responds as normal response.
- c) In case of receiving abnormal frame, it responds by using error code.

#### (4) Error check area

How to check error of frame takes 2's complement except start and end of frame and converts it as ASCII.



## 2) Frame structure in RTU mode

Frame structure in the RTU mode is as follows.

Classification	Start	Station number	Function code	Data	Error check	End
size(byte)	Idle time	1	1	N	2	Idle time

### (1) Characteristic of RTU mode

- It uses hexadecimal.
- Start character is station number and frame is classified by CRC error check.
- Start and end of frame is classified by adding idle time of 1 bit.
- Between frames, there is interval of 3.5 character time. When exceeding 1.5 character time, it is acknowledged as independent frame.

### (2) Address area

- It consists of 1 byte.
- When using the XGT Cnet I/F module, range of station is 0~31.
- Station number 0 is used for client.
- When server responds, it contains self address to response frame to know client's response.

### (3) Data area

- Transmits the data by using the Hex. data, data structure changes according to function code.
- In case of receiving normal frame, it responds as normal response.
- In case of receiving abnormal frame, it responds by using error code.

### (4) Error check area

It determines if frame is normal or not by using CRC check of 2 byte.

### (5) Modbus address regulation

Address in the data starts from 0 and it is same with value that is minus 1 from modbus memory, Modbus address is same with address 1 of data.

## 3) Expression of data and address

To express data and address of modbus protocol, the characteristic is as follows.

- It used hexadecimal as basic form.
- In the ASCII mode, Hex data is converted into ASCII code.
- RTU mode uses Hex data.
- Each function code has following meaning.

Code(Hex)	Purpose	Used area	address	Max. response data
01	Read Coil Status	Bit output	0XXXX	2000bit
02	Read Input Status	Bit input	1XXXX	2000bit
03	Read Holding Registers	Word output	4XXXX	125word
04	Read Input Registers	Word input	3XXXX	125word
05	Force Single Coil	Bit output	0XXXX	1bit
06	Preset Single Register	Word output	4XXXX	1word
0F	Force Multiple Coils	Bit output	0XXXX	1968bit
10	Preset Multiple Registers	Word output	4XXXX	120word

## Chapter 2 Built-in Cnet communication

### Modbus Instruction

#### 4) Reading data of bit type at the bit output (01)

##### (1) Reading bit of output area (function code: 01)

In case of reading data of bit type, request and response frame is as follows.

Detail of frame is applied in case of ASCII mode.

##### (a) Request frame

Frame	Station no.	Function code (01)	Address	Data size	Frame error check	Tail (CRLF)
Size (byte)	1	1	2	2	2	2

##### (b) Response frame (In case of receiving normal frame)

Frame	Station no.	Function code (01)	No. of byte	Data	Frame error check	Tail (CRLF)
Size (byte)	1	1	2	N	2	2

##### (c) In case of response frame (In case of receiving abnormal frame)

Frame	Station no.	Error code	Exceptional code	Tail (CRLF)
Size (byte)	1	1	1	2

##### (2) Details of frame

- (a) Station no.: indicates the station no. of slave to read bit of output area.
- (b) Function code: '01' indicating Read Coil Status
- (c) Address: start address of data to read and it consists of 2 byte. At this time, start address conforms to modbus address regulation.
- (d) Data size: size of data to read and it consists of 2 byte.
- (e) Frame error check: in case of ASCII mode, it uses LRC and in case of STU mode, it uses CRC. It consists of 2 byte.
- (f) Tail: it is applies in case of ASCII mode, CRLF is added after LRC.
- (g) No. of byte: no. of byte of response data
- (h) Data: makes address of request frame as start address and transmits data with byte unit
- (i) Error code: error code is expressed by adding 80(Hex) to function code and in case of reading bit of output area, it is expressed as 81(Hex).
- (j) Exceptional code: indicates detail of error and consists of 1 byte

## (3) Frame example

Example that requests reading bit of 20~28 to station number 1 server acting as modbus RTU mode

## (a) Request frame

Classification	Station no.	Function code	Address		Data size		Error check
			Upper byte	Lower byte	Upper byte	Lower byte	
Frame	01	01	00	13	00	13	CRC

## (b) Response frame (In case receiving normal frame)

Classification	Station no.	Function code	No. of byte	Data			Error check
Frame	01	01	03	12	31	05	CRC

## (c) Response frame (In case of receiving abnormal frame)

Classification	Station no.	Function code	Exceptional code	Error check
Frame	01	81	02	CRC

## Chapter 2 Built-in Cnet communication

### 5) Reading data of bit type at the bit input (02)

#### (1) Reading bit of input area

In case of reading data of bit type of input area, request and response frame is as follows.

Tail of frame is applied in case of ASCII mode.

#### (a) Request frame

Classification	Station no.	Function code (02)	Address	Data size	Frame error check	Tail (CRLF)
Size (byte)	1	1	2	2	2	2

#### (b) Response frame (In case of receiving normal frame)

Classification	Station no.	Function code (02)	No. of byte	Data	Frame error check	Tail (CRLF)
Size (byte)	1	1	2	N	2	2

#### (c) Response frame (In case of receiving abnormal frame)

Classification	Station no.	Error code	Exceptional code	Tail (CRLF)
Size (byte)	1	1	1	2

#### (2) Details of frame

(a) Station no.: indicates station no. of slave to read bit of input area

(b) Function code: '02' indicating Read Input Status

(c) Address: indicating start address of data to read. It consists of 2 byte. At this time, start address conforms to modbus address regulation.

(d) Data size: size of data to read, consists of 2 byte

(e) Frame error check: in case of ASCII mode, it uses LRC and in case of STU mode, it uses CRC for error check. It consists of 2 byte.

(f) Tail: it is applied in case of ASCII mode, CRLF is added after LRC.

(g) No. of byte: no. of byte of data responding

(h) Data: address of request frame is start address and transmits data with byte unit.

(i) Error code: Error code is expressed by adding 80(Hex) and in case of reading bit of output area, it is expressed 82(Hex).

(j) Exceptional code: details of error, consists of 1 byte.

#### (3) Frame example

Example that reads bit (20~38) from station number 1 server acting as modbus RTU

#### (a) Request frame

Classification	Station no.	Function code	Address		Data size		Error check
			Upper byte	Lower byte	Upper byte	Lower byte	
Frame	01	02	00	13	00	13	CRC

#### (b) Response frame (When receiving normal frame)

Classification	Station no.	Function code	No. of byte	Data			Error check
Frame	01	02	03	12	31	05	CRC

(c) Response frame (When receiving abnormal frame)

Classification	Station no.	Function code	Exceptional code	Error check
Frame	1	82	2	CRC

6) Reading data of word type at the word output (03)

(1) Reading word of output area

When reading data of word type of output area, request and response frame is as follows.

Tail of frame is applied in case of ASCII mode.

(a) Request frame

Classification	Station no.	Function code (03)	Address	Data size	Frame error check	Tail (CRLF)
Size (byte)	1	1	2	2	2	2

(b) Response frame (When receiving normal frame)

Classification	Station no.	Function code (03)	No. of byte	Data	Frame error check	Tail (CRLF)
Size (Byte)	1	1	2	N*2	2	2

(c) Response frame (When receiving abnormal frame)

Classification	Station no.	Error code	Exceptional code	Tail (CRLF)
Size (byte)	1	1	1	2

(2) Details of frame

- (a) Station no.: indicates the station no. of slave to read word data of output area.
- (b) Function code: '03' indicating Read Holding Registers
- (c) Address: indicating start address of data to read. It consists of 2 byte. At this time, start address conforms to modbus address regulation.
- (d) Data size: size of data to read, consists of 2 byte
- (e) Frame error check: in case of ASCII mode, it uses LRC and in case of STU mode, it uses CRC for error check. It consists of 2 byte.
- (f) Tail: it is applied in case of ASCII mode, CRLF is added after LRC.
- (g) No. of byte: no. of byte of data responding
- (h) Data: address of request frame is start address and transmits data with byte unit. At this time, since data is word type, it is double of no. of byte.
- (i) Error code: error code is expressed by adding 80(Hex) and in case of reading word of output area, it is expressed 83(Hex).
- (j) Exceptional code: details of error, consists of 1 byte.

(3) Frame example

Example that reads word (108~110) from station number 1 server acting as modbus RTU

(a) Request frame

Classification	Station no.	Function code	Address		Data size		Error check
			Upper byte	Lower byte	Upper byte	Lower byte	
Frame	01	03	00	6B	00	03	CRC

## Chapter 2 Built-in Cnet communication

(b) Response frame (receiving normal frame)

Classification	Station no.	Function code	No. of byte	Data						Error check
Frame	01	03	06	13	12	3D	12	40	4F	CRC

(c) Response frame (receiving abnormal frame)

Classification	Station no.	Function code	Exceptional code	Error check
Frame	01	83	04	CRC

### 7) Reading data of word type at the word input (04)

(1) Reading word of input area

In case of reading word of input area, request and response frame is as follows.

Tail of frame is applied in case of ASCII mode.

(a) Request frame

Classification	Station no.	Function code (04)	Address	Data size	Frame error check	Tail (CRLF)
Size (byte)	1	1	2	2	2	2

(b) Response frame (In case of receiving normal frame)

Classification	Station no.	Function code (04)	No. of byte	Data	Frame error check	Tail (CRLF)
Size (byte)	1	1	2	N*2	2	2

(c) In case of response frame (In case of receiving abnormal frame)

Classification	Station no.	Error code	Exceptional code	Tail (CRLF)
Size (byte)	1	1	1	2

(2) Details of frame

(a) Station no.: indicates the station no. of slave to read word of input area.

(b) Function code: '04' indicating Read Input Registers

(c) Address: start address of data to read and it consists of 2 byte. At this time, start address conforms to modbus address regulation.

(d) Data size: size of data to read and it consists of 2 byte.

(e) Frame error check: in case of ASCII mode, it uses LRC and in case of STU mode, it uses CRC. It consists of 2 byte.

(f) Tail: it is applies in case of ASCII mode, CRLF is added after LRC.

(g) No. of byte: no. of byte of response data

(h) Data: makes address of request frame as start address and transmits data with byte unit. At this time, since data is word type, it is double of no. of byte.

(i) Error code: error code is expressed by adding 80(Hex) to function code and in case of reading word of input area, it is expressed as 84(Hex).

(j) Exceptional code: indicates detail of error and consists of 1 byte

(3) Frame example

Example that requests reading word of 9 to station number 1 server acting as modbus RTU mode

(a) Request frame

Classification	Station no.	Function code	Address		Data size		Error check
			Upper byte	Lower byte	Upper byte	Lower byte	
Frame	01	04	00	08	00	01	CRC

(b) Response frame (In case receiving normal frame)

Classification	Station no.	Function code	No. of byte	Data		Error check
Frame	01	04	02	00	0A	CRC

(c) Response frame (In case of receiving abnormal frame)

Classification	Station no.	Function code	Exceptional code	Error check
Frame	01	84	04	CRC

**8) Individual writing data of bit type at the bit output (05)**

**(1) Individual writing bit of output area**

When writing single bit of output area, request and response frame is as follows.

Tail of frame is applied in case of ASCII mode.

**(a) Request frame**

Classification	Station no.	Function code (05)	Address	Output	Frame error check	Tail (CRLF)
Size (byte)	1	1	2	2	2	2

**(b) Response frame (In case of receiving normal frame)**

Classification	Station no.	Function code (05)	Address	Output	Frame error check	Tail (CRLF)
Size (byte)	1	1	2	2	2	2

**(c) In case of response frame (In case of receiving abnormal frame)**

Classification	Station no.	Error code	Exceptional code	Tail (CRLF)
Size (byte)	1	1	1	2

**(2) Details of frame**

- (a) Station no.: indicates the station no. of slave to write single bit of output area.
- (b) Function code: '05' indicating Force Single Coil
- (c) Address: start address of data to write and it consists of 2 byte. At this time, start address conforms to modbus address regulation.
- (d) Output: in case of turning on address set in the Address, FF00(Hex) is indicated and in case of turning off address set in the Address, it is indicated 0000(Hex).
- (e) Frame error check: in case of ASCII mode, it uses LRC and in case of STU mode, it uses CRC. It consists of 2 byte.
- (f) Tail: it is applies in case of ASCII mode, CRLF is added after LRC.
- (g) No. of byte: no. of byte of response data
- (h) Error code: error code is expressed by adding 80(Hex) to function code and in case of Force Single Coil, it is expressed as 85(Hex).
- (i) Exceptional code: indicates detail of error and consists of 1 byte

**(3) Frame example**

Example that turning on 9<sup>th</sup> bit to station number 1 server acting as Modbus RTU mode

**(a) Request frame**

Classification	Station no.	Function code	Address		Output		Error check
			Upper byte	Lower byte	Upper byte	Lower byte	
Frame	01	05	00	08	FF	00	CRC

**(b) Response frame (In case receiving normal frame)**

Classification	Station no.	Function code	Address		Output		Error check
			Upper byte	Lower byte	Upper byte	Lower byte	
Frame	01	05	00	08	FF	00	CRC



(c) Response frame (In case of receiving abnormal frame)

Classification	Station no.	Function code	Exceptional code	Error check
Frame	01	85	04	CRC

9) Individual writing data of word type at the word output (06)

(1) Individual writing word of output area

In case of writing single word to output area, request and response frame is as follows.  
Detail of frame is applied in case of ASCII mode.

a) Request frame

Classification	Station no.	Function code (06)	Address	Output	Frame error check	Tail (CRLF)
Size (byte)	1	1	2	2	2	2

b) Response frame (In case of receiving normal frame)

Classification	Station no.	Function code (06)	Address	Output	Frame error check	Tail (CRLF)
Size (byte)	1	1	2	2	2	2

c) In case of response frame (In case of receiving abnormal frame)

Classification	Station no.	Error code	Exceptional code	Tail (CRLF)
Size (byte)	1	1	1	2

(2) Details of frame

- (a) Station no.: indicates the station no. of slave to write single word of output area.
- (b) Function code: '06' indicating Preset Single Register
- (c) Address: start address of data to write and it consists of 2 byte. At this time, start address conforms to modbus address regulation.
- (d) Output: data value to write in the address set in the Address.
- (e) Frame error check: in case of ASCII mode, it uses LRC and in case of STU mode, it uses CRC. It consists of 2 byte.
- (f) Tail: it is applies in case of ASCII mode, CRLF is added after LRC.
- (g) No. of byte: no. of byte of response data
- (h) Error code: error code is expressed by adding 80(Hex) to function code and in case of writing single word of output area, it is expressed as 86(Hex).
- (i) Exceptional code: indicates detail of error and consists of 1 byte

(3) Frame example

Example writing 0003(Hex) to 9<sup>th</sup> word of station number 1 server acting as modbus RTU mode

(a) Request frame

Classification	Station no.	Function code	Address		Output		Error check
			Upper byte	Lower byte	Upper byte	Lower byte	
Frame	01	06	00	08	00	03	CRC

(b) Response frame (In case receiving normal frame)

Classification	Station no.	Function code	Address		Output		Error check
			Upper byte	Lower byte	Upper byte	Lower byte	
Frame	01	06	00	08	00	03	CRC

(c) Response frame (In case of receiving abnormal frame)

Classification	Station no.	Function code	Exceptional code	Error check
Frame	01	86	02	CRC

**10) Continuous writing data of bit type at the bit output (0F)**

(1) Continuous writing bit of output area

In case of writing continuous bit to output area, request and response frame is as follows.  
Tail of frame is applied in case of ASCII mode.

(a) Request frame

Classification	Station no.	Function code (0F)	Address	No. of output	Data size	Output	Frame error check	Tail (CRLF)
Size (byte)	1	1	2	2	1	N	2	2

(b) Response frame (In case of receiving normal frame)

Classification	Station no.	Function code (0F)	Address	No. of output	Frame error check	Tail (CRLF)
Size (byte)	1	1	2	2	2	2

(c) In case of response frame (In case of receiving abnormal frame)

Classification	Station no.	Error code	Exceptional code	Tail (CRLF)
Size (byte)	1	1	1	2

(2) Details of frame

- (a) Station no.: indicates the station no. of slave to write continuous bit of output area.
- (b) Function code: '06' indicating Force Multiple Coils
- (c) Address: start address of data to read and it consists of 2 byte. At this time, start address conforms to Modbus address regulation.
- (d) No. of output: no. of output to write and it consists of 2 byte  
Ex.) When writing 10 continuous data from address number 20, no. of output is 000A(Hex)
- (e) Data size: indicates no. of output as byte. Namely, in case data size is 1, no. of data is 9.  
Ex.) In case of writing 10 continuous bits, data size is 2.
- (f) Output: data value to write in the address set in the Address.
- (g) Frame error check: in case of ASCII mode, it uses LRC and in case of STU mode, it uses CRC. It consists of 2 byte.
- (h) Tail: it is applies in case of ASCII mode, CRLF is added after LRC.
- (i) No. of byte: no. of byte of response data
- (j) Error code: error code is expressed by adding 80(Hex) to function code and in case of writing continuous bit of output area, it is expressed as 8F(Hex).
- (k) Exceptional code: indicates detail of error and consists of 1 byte.

(3) Frame example

Example writing 10 continuous bits starting 20<sup>th</sup> address of 1 server acting as Modbus RTU mode

Ex.) Data value to write continuously

Bit value	1	1	0	0	1	1	0	1	0	0	0	0	0	0	0	1
Hex	C				D				0				1			
Address	27	26	25	24	23	22	21	20	-	-	-	-	-	-	29	28

(a) Request frame

Classification	Station no.	Function code	Address		No. of output		Data size	Output		Error check
			Upper byte	Lower byte	Upper byte	Lower byte		Upper byte	Lower byte	
Frame	01	0F	00	13	00	0A	02	CD	01	CRC

(b) Response frame (In case receiving normal frame)

Classification	Station no.	Function code	Address		No. of output		Error check
			Upper byte	Lower byte	Upper byte	Lower byte	
Frame	01	04	00	13	00	0A	CRC

(c) Response frame (In case of receiving abnormal frame)

Classification	Station no.	Function code	Exceptional code	Error check
Frame	01	8F	01	CRC

## Chapter 2 Built-in Cnet communication

### 11) Continuous writing data of word type at the word output (10)

#### (1) Continuous writing word of output area

In case of writing word continuously to output area, request and response frame is as follows.  
Tail of frame is applied in case of ASCII mode.

##### (a) Request frame

Classification	Station no.	Function code (10)	Address	No. of output	Data size	Output	Frame error check	Tail (CRLF)
Size (byte)	1	1	2	2	1	N*2	2	2

##### (b) Response frame (In case of receiving normal frame)

Classification	Station no.	Function code (10)	Address	No. of output	Frame error check	Tail (CRLF)
Size (byte)	1	1	2	2	2	2

##### (c) In case of response frame (In case of receiving abnormal frame)

Classification	Station no.	Error code	Exceptional code	Tail (CRLF)
Size (byte)	1	1	1	2

#### (2) Details of frame

- (a) Station no.: indicates the station no. of slave to write continuous word of output area.
- (b) Function code: '10' indicating Preset Multiple Registers
- (c) Address: start address of data to read and it consists of 2 byte. At this time, start address conforms to modbus address regulation.
- (d) No. of output: no. of output to write and it consists of 2 byte  
Ex.) When writing 10 continuous data from address number 20, no. of output is 000A(Hex)
- (e) Data size: indicates no. of output as byte. Since data type is word, in case of writing data of 1 word, data size is 2.
- (f) Output: data value to write in the address set in the Address.
- (g) Frame error check: in case of ASCII mode, it uses LRC and in case of STU mode, it uses CRC. It consists of 2 byte.
- (h) Tail: it is applies in case of ASCII mode, CRLF is added after LRC.
- (i) No. of byte: no. of byte of response data
- (j) Error code: error code is expressed by adding 80(Hex) to function code and in case of writing continuous word of output area, it is expressed as 90(Hex).
- (k) Exceptional code: indicates detail of error and consists of 1 byte.

(3) Frame example

Example writing continuous 2 words starting 20<sup>th</sup> address of server 1 acting as Modbus RTU mode

Ex.) value to write continuously

Hex	C	D	0	1	0	0	0	0	A
Address	20				21				

(a) Request frame

Classification	Station no.	Function code	Address		No. of output		Data size	Output				Error check
			Upper byte	Lower byte	Upper byte	Lower byte						
Frame	01	10	00	13	00	02	04	CD	01	00	0A	CRC

(b) Response frame (In case receiving normal frame)

Classification	Station no.	Function code	Address		No. of output		Error check
			Upper byte	Lower byte	Upper byte	Lower byte	
Frame	01	10	00	13	00	02	CRC

(c) Response frame (In case of receiving abnormal frame)

Classification	Station no.	Function code	Exceptional code	Error check
Frame	01	90	01	CRC

## 2.9 Diagnosis Function

With XG5000 used, the status of the system and the network can be checked and diagnosed. Diagnosis function is composed as described below

- ▶ CPU module information
- ▶ Communication module information
- ▶ Frame monitor
- ▶ Status by service

### 2.9.1 Diagnosis Function of XG5000

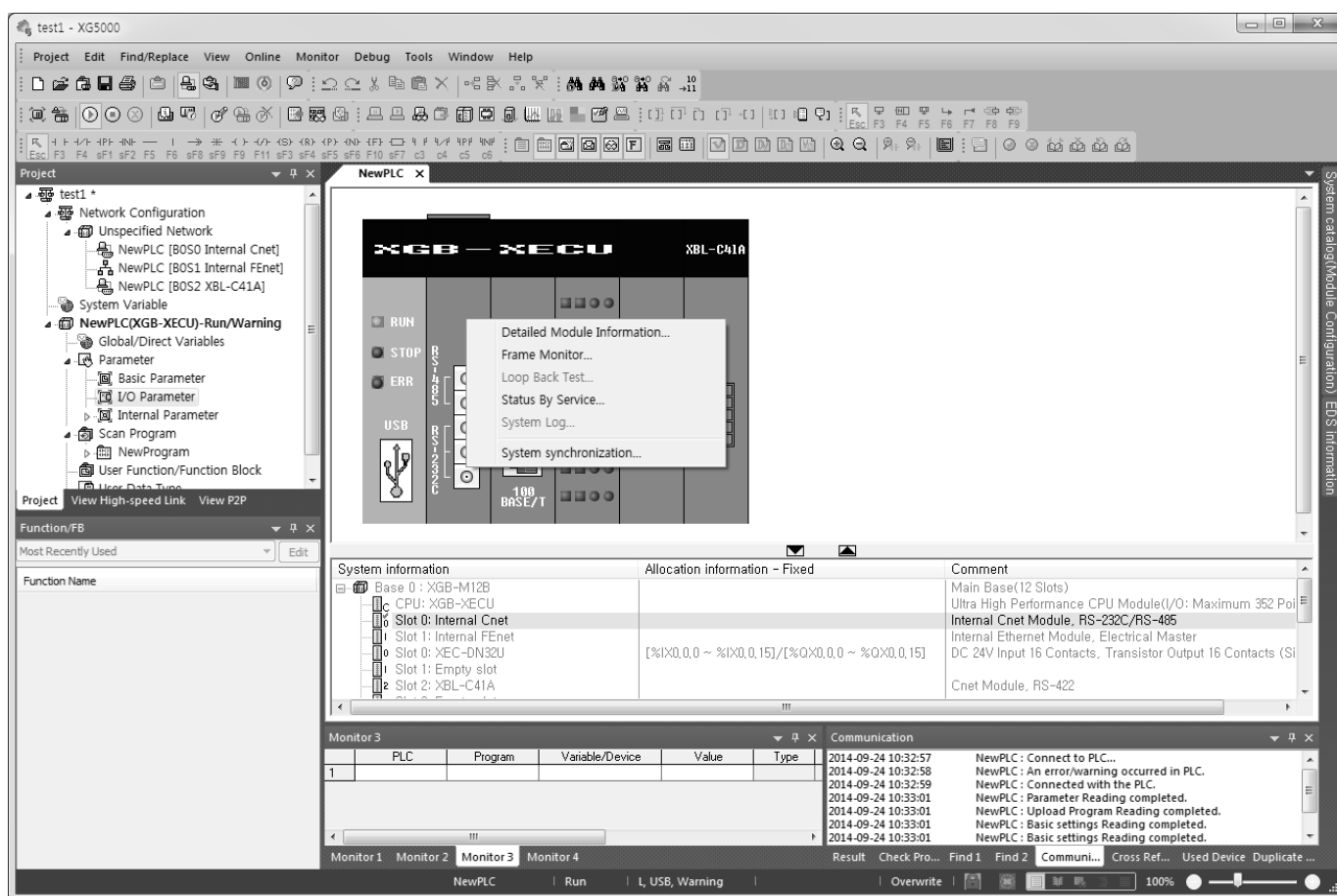

How to diagnosis system and network status by XG5000 system diagnosis are described below.

Connect XG5000 to loader port of main unit and if you select “Online -> Communication module setting -> System Diagnosis”, the following window is created.





- Select [Online] – [Communication module setting] – [System Dianosis] and click the icon (  ).
- Click the right button on the the relevant module and click Frame Monitor or Status By Service to check.

1) Checking status of main unit

Check list	Detail result
CPU Module information	
<p>1. Select [Online] – [Communication module setting] – [System Diagnosis] or click the icon (  ).</p> <p>2. You can check the status of main unit by clicking CPU module information after clicking main unit.</p>	

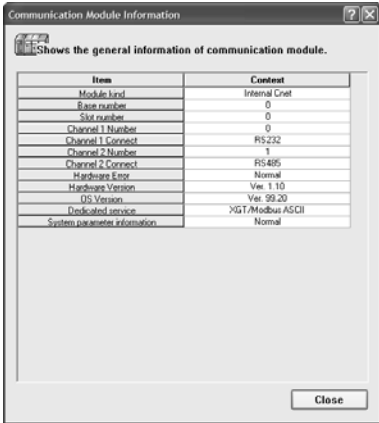
2) Communication module information

Check list	Detail result
Communication module information	
<p>1. Select [Online] – [Communication module setting] – [System Diagnosis] or click the icon (  ).</p> <p>2. You can check communication module status by clicking communication module information and click the right button after clicking Cnet I/F module and built-in communication.</p> <p>3. Meaning of each item of communication module information is as follows.</p>	

Item	Content	Remark
Module kind	Information of module kind under diagnosis	
Base number	Base information of communication module under diagnosis. It is fixed as 0 at XGB PLC.	
Slot number	Slot no. of communication module under diagnosis In case of built-in communication, it is fixed as 0.	
Station number	Station no. of relevant channel used at dedicated service, P2P	
Connection method	Information of communication type (RS-232C, RS-422) of relevant channel	
Hardware error	Indicates whether hardware of communication module is normal or not.	
Hardware version	Version of communication module hardware	
OS version	Indicates version of communication module OS	
P2P	Indicates whether P2P communication is activated or not	
System parameter information	Whether standard communication parameter is downloaded or not Standard communication parameter error information expression	

## Chapter 2 Built-in Cnet communication

### 3) Frame monitor

The user can check whether frame is normal or not by monitoring TRX frame through Cnet I/F module by XG-PD's frame monitor.

Check list	Detail result
Frame monitor	

1. Select [Online] – [Communication module setting] – [System Diagnosis] or click the icon ( ).
2. If you click right button after clicking Cnet I/F module and click frame monitor, you can monitor current communication data.
3. If you use frame monitor function, you can check frame of TRX data between Cnet I/F module and external communication device easily.
4. Detailed content of information indicated frame monitor window is as follows.

Item		Content	Remark
Standard information	Base No.	Information of base number under diagnosis	
	Slot No.	Information of slot number under diagnosis	
Monitor selections	Select Channel	Select channel to monitor	
Frame monitor window	Form	Indicates whether it is TX or RX frame.	
	Result	Indicates the protocol type 1) XGT server 2) XGT client 3) Modbus server 4) Modbus client 5) User definition frame 6) Unknown: frame that Cnet can't deal with	
	Size	Size of frame	
	Time	Time when sending/receiving the frame In case main unit is standard type (XBM-D***S), it indicates elapsed time from start.	
	Frame data	Indicates the frame data	
View by HEX		Indicates the frame data as HEX	
View by ASCII		Indicates the frame data as ASCII	
Start		Starts the frame monitor	
Stop		Stops the frame monitor	
Close		Closes the frame monitor window	

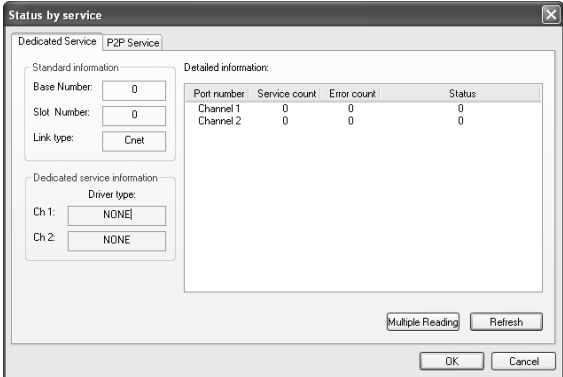

4) Status by service(Dedicated Service)

Check list	Detail result
Dedicated service	

1. Select [Online] – [Communication module setting] – [System Diagnosis] or click the icon (  ).
2. Click the right button on the the Cnet I/F module and click Status By Service.
3. Click Dedicated Service tap.
4. Check the status by service by clicking Multiple Reading and Refresh
5. Detailed content of information indicated in dedicated service window is as follows.

Classification	Item	Content	
Multiple reading/Refresh	Multiple reading	Checks the dedicated service status every second.	
	Refresh	Checks the dedicated service status information at started time	
Dedicated Service	Standard information	Base Number	Information of base number under diagnosis
		Slot Number	Information of slot number under diagnosis
		Link type	Type of communication module under diagnosis
	Dedicated service information		Drive type by service
	Detailed information window	Port number	Channel number
		Service count	Indicates how many dedicated service communication is done
		Error count	Indicates how many error occurs during dedicated service communication
Status		Indicates status of dedicated service communication	

## Chapter 2 Built-in Cnet communication

### 5) Status by service(P2P Service)

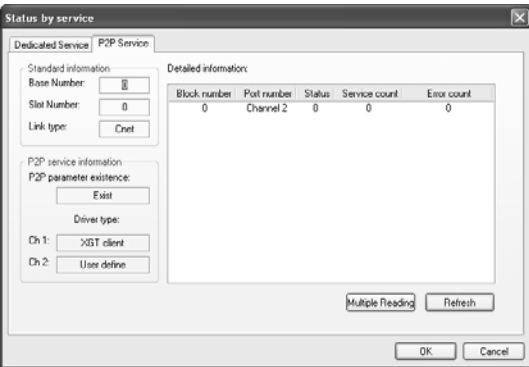
Check list	Detail result
P2P service	

1. Select [Online] – [Communication module setting] - [System diagnosis] or click the icon (  ).
2. Click the right button on the the Cnet I/F module and click Status By Service.
3. Click P2P service of Status by Service
4. Click mutiple reading and check Status by Service.

Classification	Item	Contents	
P2P service	Standard information	Base number	Information of base number under diagnosis
		Slot number	Information of slot number under diagnosis
		Link type	Type of communication module under diagnosis
	P2P service information	P2P parameter existence	Indicates whether P2P parameter exists or not
		Driver type	Indicates the P2P driver by port XGT/Modbus/User definition frame
	Detailed information	Block number	Available range:0~63 Only block under operation is indicated.
		Port number	Indicates the channel number
		Status	Indicates the status by service
		Service count	Indicates how many P2P service is done.
Error count		Indicates how many error occurs during service	
Multiple reading/Refresh	Multiple reading	Checks the P2P service status every second.	
	Refresh	Check the P2P service status when refresh is done.	

## 6) Service status code

It is used to check whether Cnet I/F module is normal or not.

Dedicated service		P2P service	
Status	Meaning	Status	Meaning
0	Normal	0	Normal
1	Error of RX frame head (There is no ACK/NAK.)	4	Error of max. station number (Available range: 0~255)
2	Error of RX frame tail (There is no tail.)	5	Time out
3	BCC error of RX frame	FFFE	1. Modbus address error 2. Commands except Read/Write are used.
9	Station number of RX frame is different with self station number (Self station number = 0)		
0A	In case of not get response from CPU		
0B	RX frame size exceeds the modbus max. frame size		
0C	RX frame is not Modbus ASCII/RTU.		
0D	HEX conversion error in Modbus		

### 2.9.2 Trouble Shooting by Error

#### 1) Trouble shooting when P2P parameter setting error occurs in case of XG5000 connection

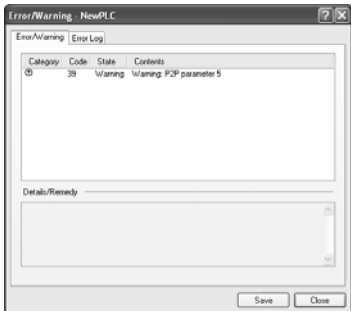
Phenomenon	Reason	Trouble shooting
<p>P2P setting error warning in case of XG5000 connection</p> 	<p>In case of enabling link, the user enabled the link where P2P is not set</p>	<ol style="list-style-type: none"> <li>1. In Enable Link menu of XG5000, check P2P setting number and delete P2P number not selected properly.</li> <li>2. After disconnecting XG-PD, connect XG5000 again and check</li> </ol>

#### 2) Trouble shooting when communication is not done after P2P client setting

Phenomenon	Reason	Trouble shooting
<p>Tough communication setting is completed, Tx/Rx LED of Cnet I/F doesn't flicker</p>	<p>In case CPU is stop mode</p>	<p>Connect XG5000 and check CPU mode. If CPU mode is stop, change mode into RUN.</p>
	<p>Non-coincidence of communication standard parameter between client and server</p>	<p>Connect XG-PD and click [File] – [Open from PLC]. Check standard settings of module acting as client and server.</p>
	<p>Enable Link setting error</p>	<p>After executing P2P parameter, enable right P2P link</p>

#### 3) Trouble shooting when response frame is missed in case of acting as client and using RS-485

Phenomenon	Reason	Trouble shooting
<p>After setting diverse P2P parameter in P2P block, if frame monitor is executed, response frame is missed.</p>	<p>In case P2P conditional flag is faster than communication time</p>	<ol style="list-style-type: none"> <li>1. Consider communication time and change P2P conditional flag.</li> <li>2. Communication time: transmission time + reception time                      - transmission time: conditional flag+CPU Scan Time+reaction time of communication module+data transmission time                      - reception time: CPU Scan Time + reaction time of communication module+data transmission time</li> </ol>
	<p>In case that response time of partner is slow.</p>	<ol style="list-style-type: none"> <li>1. Increase Delay time in standard settings of XG-PD.</li> </ol>

## 4) Two response frame are dealt with as unknown when executing frame monitor

Phenomenon					Reason	Trouble shooting
Two response frame are dealt with as unknown when executing frame monitor					Communication type in XG-PD is set as RS-422 but output wiring method is RS-485	Change communication type as RS-485 and write it to PLC.
Transmission	XGT master	17	2007/12/4 ...	ENQ 01rS S 0104 %M W 0EOT 40		
Reception	Unknown	17	2007/12/4 ...	ENQ 01rS S 0104 %M W 0EOT 40		
Reception	Unknown	17	2007/12/4 ...	ACK 01rS S 01020000ETX 05		
Transmission	XGT master	17	2007/12/4 ...	ENQ 01rS S 0104 %M W 0EOT 40		

## 5) Unable to analyze TRX frame

Phenomenon	Reason	Trouble shooting
Unable to analyze TRX frame	More than one server sends frame	1. Execute 1:1 communication with server and check if it works properly. 2. Take interlock for servers not to sends frame simultaneously.
	In case parity bit setting is not coincident	Set the parity bit to be same each other
	In case stop bit setting is not coincident	Set the stop bit to be same each other
	In case communication speed setting is not coincident	Set the communication speed to be same each other
	In case of multi drop, terminal resistance is not installed	Install terminal resistance

## 6) Unable to know which one is reason of error, client or server

Phenomenon	Reason	Trouble shooting
Unable to know which one is reason of error, client or server	-	1. Check Cnet I/F module - Check module's equipment status - Check wiring 2. Check main unit status

## Chapter 2 Built-in Cnet communication

## 7) Communication is not normal or communication is not executed repeatedly

Phenomenon	Reason	Trouble shooting
Communication is not normal or communication is not executed repeatedly	In case of multi drop, More than one server sends frame	1. Execute 1:1 communication with server and check if it works properly. 2. Take interlock for servers to sends frame simultaneously.
	Connection error of wiring communication line	Change cable or check connection of cable
	In case of RS-485 (Half duplex), non-coincidence of timing of TRX signal	Increase delay time of client and server
	1. When transmission is not complete, it requests next process of transmission 2. When reception is not complete, it requests next process of reception	Use handshake in program thoroughly



## 2.10 Example Program

### 2.10.1 Setting of Cnet I/F Module in the XG5000



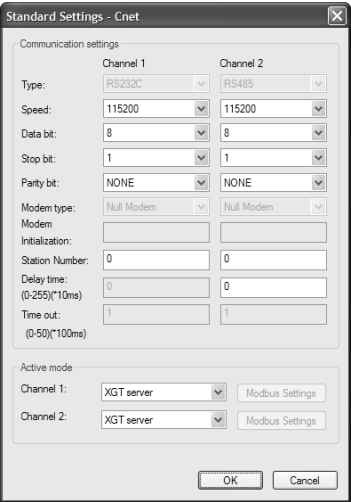

Operation of XGT Cnet I/F is divided into P2P service and Server.

- P2P service: acts as client (master) and request reading/writing.
  - XGT client
  - Modbus RTU/ASCII client
  - User frame definition
- Server: acts as server (slave) and acts according to request
  - XGT server
  - Modbus RTU server
  - Modbus ASCII server

#### 1) In case of acting as server

Sequence	Procedure	Setting method
1	Connection setting	
		1. Select [Online]-[Connection Settings] or click icon (  ) 2. Click [Connect] after setting.
2	Read I/O information	Select [Online] – [Read I/O Information] or click icon (  ) Reads the information about currently equipped module.
3	Standard Settings	
		1. Double-click Cnet I/F module and execute standard setting window. Set Type, Speed, Data bit, Stop bit, station no. of connection menu. 2. Modem initialization is available in case of dial modem, not null modem. 3. Delay time setting: when sending frame, it sends frame after specific delay time. (a) Operation setting: Available when type is RS-422/485. * When using as Modbus ASCII server, data bit should be 7.

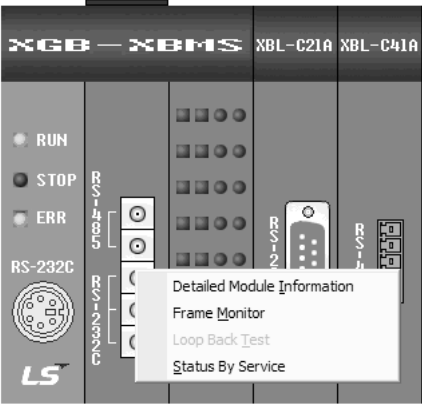
## Chapter 2 Built-in Cnet communication





Sequence	Procedure	Setting method
4	Selecting the active mode	<ol style="list-style-type: none"> <li>1. Select active mode of server for user to use.</li> <li>2. XGB Cnet I/F module supports XGT server, Modbus ASCII server, Modbus RTU server.</li> </ol>
5	Writing parameter	
		<ol style="list-style-type: none"> <li>1. Select [Online] – [Write Parameter] or click icon (  )</li> <li>2. Click [OK].</li> <li>3. If you click [OK] button, parameter is sent to PLC. If you don't reset relevant module, XGB Cnet I/F module acts as changed parameter.</li> </ol>
6	Checking the operation	
		<ol style="list-style-type: none"> <li>1. Select [Online] – [System Diagnosis] or click icon (  ).</li> <li>2. Click the right button on the relevant module and click Frame Monitor or Status By Service to check</li> </ol>

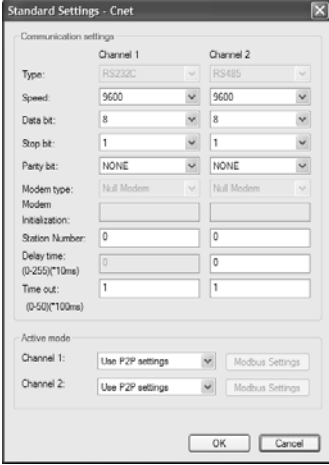
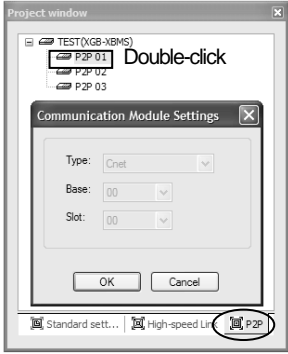
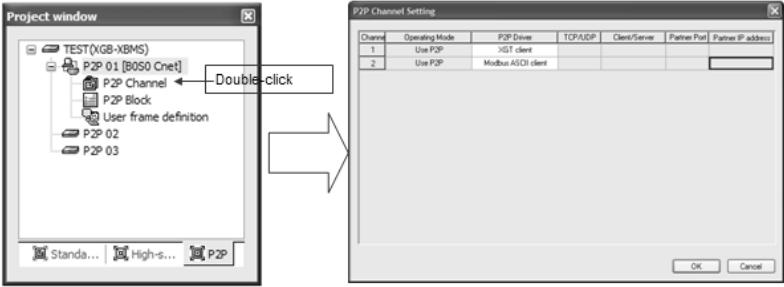

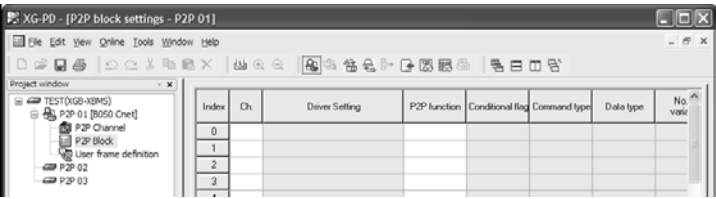

2) In case of acting as P2P service (client)

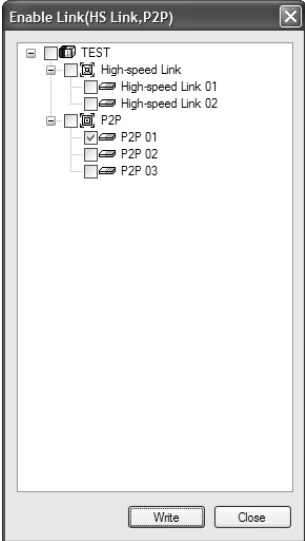
Sequence	Procedure	Setting method
1	Standard settings	1. Step 1~3 is same as described above. *In case of ASCII client, data bit should be 7.
2	Active mode	 <p>1. Select Use P2P settings as active mode.</p>
3	P2P settings	 <p>1. After selecting P2P setting window, double-click P2P block address and input base and slot no. of communication module. 2. P2P 01 is fixed as built-in Cnet and base and slot is fixed as 0 and you can't change that.</p>
4	P2P channel setting	 <p>1. Double-click P2P driver and select protocol according to each channel. 2. P2P driver supports user definition frame, XGT client, Modbus RTU/ASCII client.</p>

## Chapter 2 Built-in Cnet communication

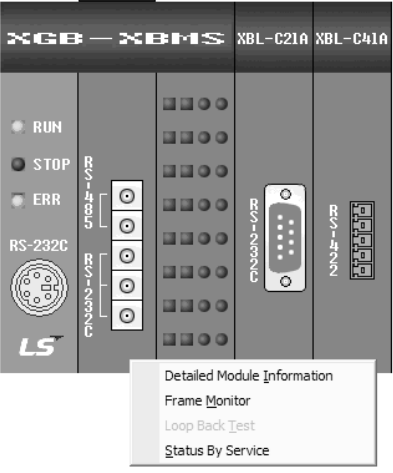
Sequence	Procedure	Setting method
5	P2P block setting	 <p>1. P2P items are activated differently according to type of client set in the channel.                  2. Write shell according to protocol                  * In case of user definition frame, P2P block can be set when user definition frame is written.</p>
6	Writing parameter	 <p>1. Select [Online] – [Write Parameter] or click icon (  ).                  2. Click [OK].                  3. If you press [OK], parameter is sent to PLC.                  If you don't reset relevant module, XGB Cnet I/F module acts as changed parameter.</p>
7	Enabling the link	 <p>1. Select [Online] – [Enable Link] or click icon (  ).                  2. Click the P2P to enable and click Write.</p>

Sequence	Procedure	Setting method
8	Checking the operation	 <p>The screenshot shows the control panel for XGB-XBMS, with modules XBL-C21A and XBL-C41A. A context menu is open over the XBL-C21A module, listing options: Detailed Module Information, Frame Monitor, Loop Back Test, and Status By Service.</p>
<ol style="list-style-type: none"> <li>1. Select [Online] – [System Diagnosis] or click icon (  ).</li> <li>2. Click the right button on the relevant module and click Frame Monitor or Status By Service to check.</li> </ol>		

### 2.10.2 Dedicated Communication Example

About Dedicated communication

- As defined protocol by LSIS, it is classified XGT client and XGT server
- XGT client: requests reading/writing of data to server
- XGT server: responds according to request of client

We assume that system configuration of dedicated service example is as [Figure 2.11.1] and communication setting is as following table.

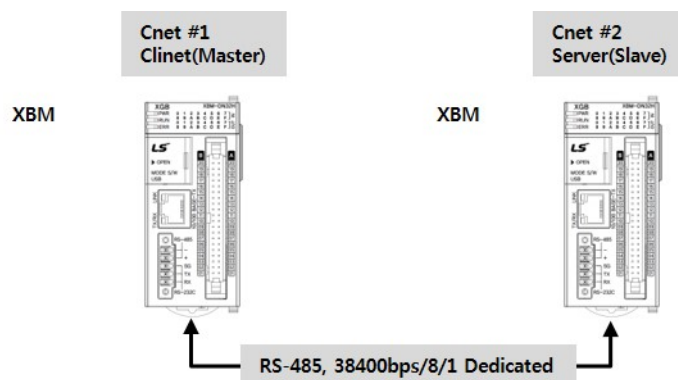

[Figure 2.11.1] Example of dedicated service system configuration

#### 1) Client setting

Type		Setting content
Main unit		XBM-DN16S
Communication module		XBL-C21A (1 slot)
Communication type		RS-232C
Communication speed		38,400
Data bit		8
Stop bit		1
Parity bit		None
Modem type		Null modem
Operation cycle		200ms
Operation status	Write	Saves 1 word of M100 at client to M100 at server
	Read	Saves 1 word of D100 at server to M110 at client

[Table 2.11.1] client setting



#### 2) Server setting

Type		Setting content
Main unit		XBC-DN32H
Communication module		Main unit built-in (RS-232C)
Communication type		RS-232C
Communication speed		38,400
Data bit		8
Stop bit		1
Parity bit		None
Modem type		Null modem
Station no.		1

[Table 2.11.2] Server setting

3) Settings of XGT server

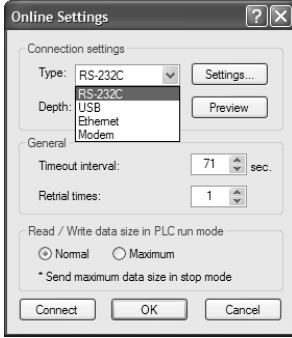

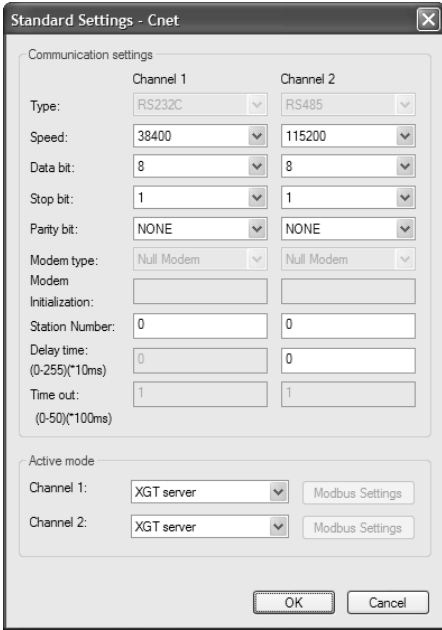
Setting method to operate built-in RS-232C communication channel of XBC-DN32H as server is as follows.

Sequence	Procedure	Setting method
1	Connection settings	
		<p>1. Select [Online]-[Connection settings] and click (  ).</p> <p>2. After setting the connection option according to user, click the 'connection'.</p>
2	Reading IO information	Select [Online]-[Read IO Information] and click icon (  ). IO information of currently mounted is shown on the project window.
3	Standard settings	
		<p>1. Set standard settings at built-in communication channel to be same with [Table 10.2.2]'s standard settings.</p> <p>2. Since active mode acts as dedicated communication server, set as XGT server.</p>





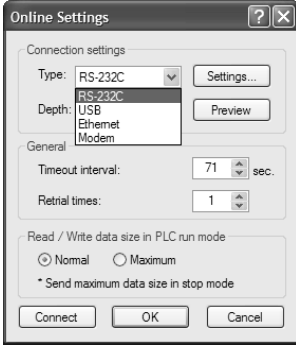

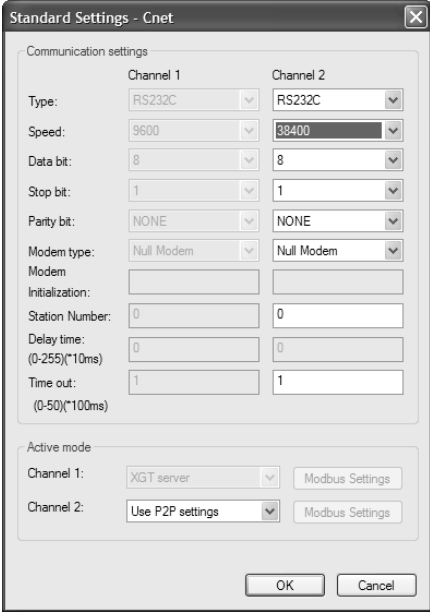
## Chapter 2 Built-in Cnet communication



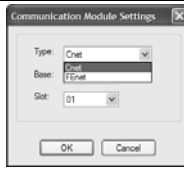

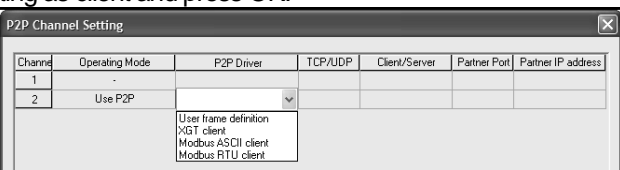
### 4) Settings of XGT client

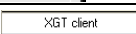
To operate XBL-C21A of client as XGT client, set Cent I/F module as follows.

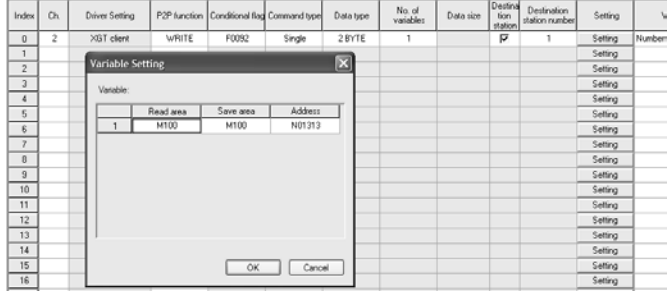
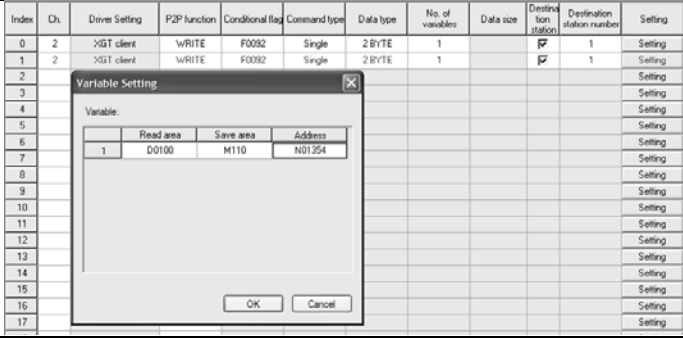
Sequence	Procedure	Setting method
1	Connection settings	
		<ol style="list-style-type: none"> <li>1. Select [Online]-[Connection settings] or click icon (  ).</li> <li>2. After setting the connection option according to user, click the 'connection'.</li> </ol>
2	Reading IO information	Select [Online]-[Read IO Information] and click icon (  ). IO information of currently mounted is shown on the project window.
3	Standard settings	
		<ol style="list-style-type: none"> <li>1. Select XBL-C21A and set standard setting at channel 2 to be same with setting described in [Table 2.11.1].</li> <li>2. In case of acting as client, station setting doesn't have the meaning so set temporary station (0~255).</li> <li>3. When acting as client, active mode should be [Use P2P settings].</li> </ol>

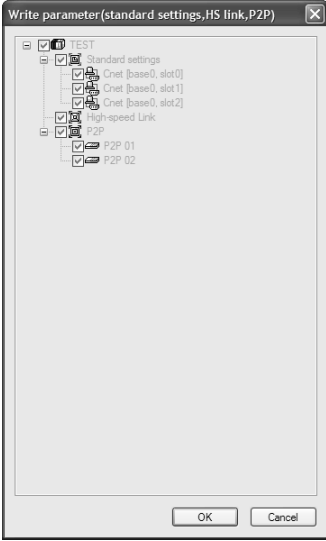
After standard settings, P2P channel and P2P block should be set. Setting methods are as follows.

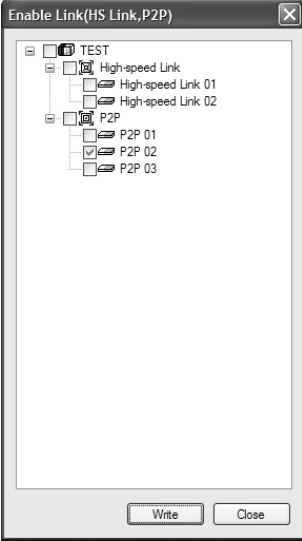

Sequence	Procedure	Setting method
1	P2P setting	Click  P2P bottom of project window.
2	Communication module settings	
		1. Double-click  of project window. (P2P 01 is fixed as built-in communication module) 2. Select slot number (no. 1) acting as client and press OK.
3	P2P channel setting	
		1. Double-click  of P2P 02 and set P2P driver of channel 2 as 
4	1. Double-click  of P2P 02.	
5	Setting of writing operation	
		1. Channel: Select ch.2 set as XGT client set in P2P channel. 2. Since it executes write operation, select WRITE. 3. Conditional flag: to send frame every 200ms, use flag F92. 4. Command type, Data type: to write 1 word, select single and 2 byte. 5. No. of variable: since no. of word is 1, select 1. 6. Destination station number: input 1 as station number of server. 7. Setting: after setting Read area and Save area, click OK. 1) Read area: device address of data saved in the client 2) Save area: device address of server to save data * If all settings are completed, color of index of channel becomes black.
6	Setting of reading operation	
		1. Channel, conditional flag, command type, data type, No. of variable, destination station no.: Same as described in setting is writing. 2. P2P function: select READ. 3. Setting: after setting Read area and Save area, click [OK]. 1) Read area: device address of data saved in server 2) Save area: device address of client to save

Sequence	Procedure	Setting method
7	Writing parameter	
<p>1. Select [Online] – [Write Parameter] or click icon (  ).</p> <p>2. Click [OK].</p> <p>3. If writing parameter is complete After clicking [OK], changed parameter is applied automatically.</p>		
8	Enabling the link	
<p>1. Select [Online] – [Enable Link] or click icon (  )</p> <p>2. Click the P2P to enable and click Write.</p>		

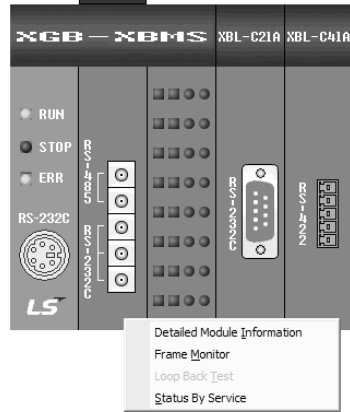

5) Checking the operation

The user can analyze frame by using the frame monitor of XG-PD to check it communication is normal or not. Method of frame monitor of Cnet I/F module is same regardless of protocol.

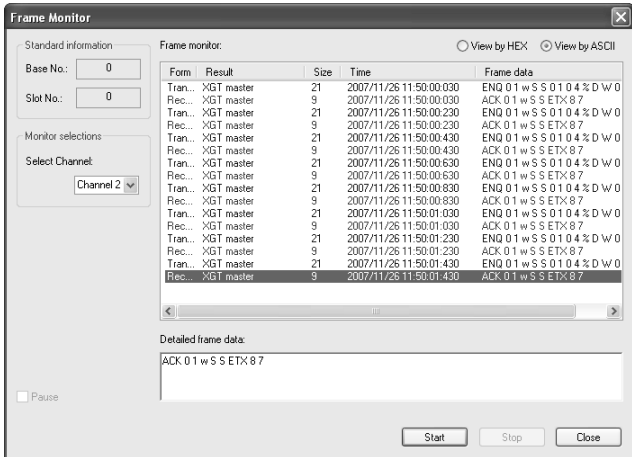
Sequence	Procedure	Setting method
1	System Diagnosis	
		<ol style="list-style-type: none"> <li>1. Connect with client by XG-PD and select [Online] – [System Diagnosis] or click (  ).</li> <li>2. Click the right button on the relevant module and click Frame Monitor or Status By Service.</li> </ol>
2	Frame monitor	
		<ol style="list-style-type: none"> <li>1. Select channel 2 and click Start.</li> <li>2. Since dedicated service is ASCII communication, select View by ASCII.</li> </ol> <p>* In case of Modbus RTU, select View by HEX and in case of Modbus ASCII, select View by ASCII.</p>

### 2.10.3 Modbus Communication Example

We assume that system configuration of Modbus communication (Modbus RTU mode) example is as [Figure 10.3.1] and communication setting is as following table.

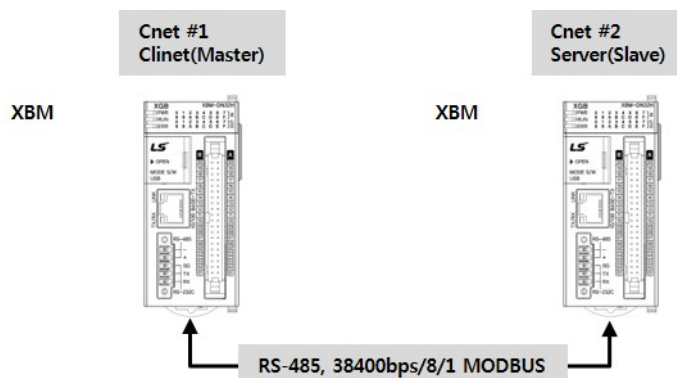

[Figure 2.11.2] XGT Modbus communication system configuration example

- Mount XBL-C41A on no. 1 slot of client PLC

#### 1) Client setting

Main unit		XBM-DN32S
Communication module		XBL-C41A(no.1 Slot)
Communication type		RS-485
Communication speed		38,400
Data bit		8
Stop bit		1
Parity bit		None
Operation cycle		200ms
Operation status	Write	<ul style="list-style-type: none"> <li>▶ Write 1 word of M100 of client to M1 of server</li> <li>▶ Write 4 words from D0 of client to M2~M5 of server</li> <li>▶ Write 15<sup>th</sup> bit of M2 to 2<sup>nd</sup> bit of M20 of server</li> <li>▶ Write 0~15<sup>th</sup> bit of M2 to 0~15<sup>th</sup> bit of M21 of server</li> </ul>
	Read	<ul style="list-style-type: none"> <li>▶ Read 1 word of M2 of server and save it at M160 of client</li> <li>▶ Read 4 words from P0 of server and save it at M150~M153</li> <li>▶ Read 1<sup>st</sup> bit of P2 of server and save it at 1<sup>st</sup> bit of M170.</li> <li>▶ Read 0<sup>th</sup> ~ 15<sup>th</sup> bit of M10 of server and save it at 0<sup>th</sup> ~ 15<sup>th</sup> of M180 of client.</li> </ul>

[client setting]



#### 2) Server setting



Main unit		XBC-DN32H
Communication type		Built-in RS-485
Communication speed		38,400
Data bit		8
Stop bit		1
Parity bit		None
Station no.		1
Start address	Bit read area Address	P0
	Bit write area Address	M0
	Word write area Address	P0
	Word write area Address	M0

[server setting]

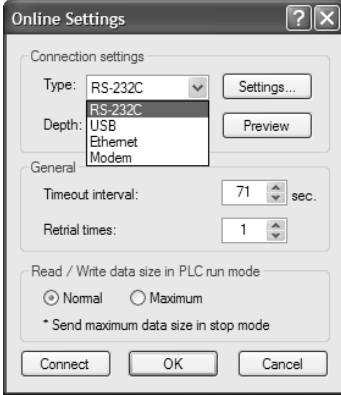
3) Modbus RTU server setting

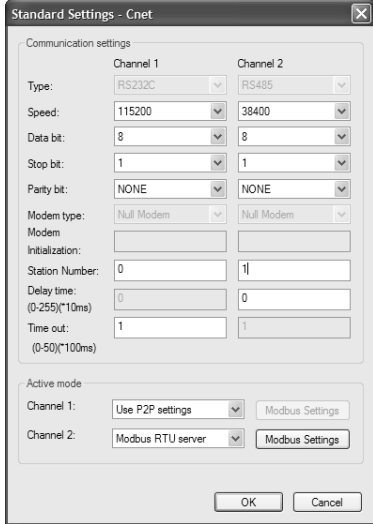
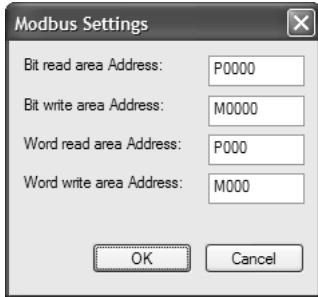

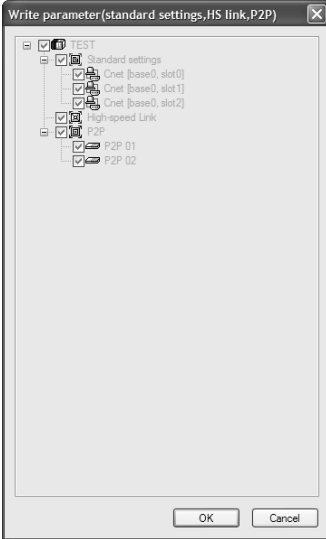
Standard settings are as follows to act built-in RS-485 communication channel of XBC-DN32H as Modbus RTU server.

Sequence	Procedure	Setting method
1	Connection setting	
		<p>1. Select [Online]-[Connection settings] or click icon (  )</p> <p>2. After setting the connection option according to user, click the 'connection'.</p>
2	Reading IO information	<p>Select [Online]-[Read IO Information] and click icon (  ). IO information of currently mounted is shown on the project window.</p>
3	Standard settings	
		<p>1. Write setting value as same with [Table 2.11.2] at built-in communication channel 1.</p> <p>2. Set active mode as Modbus RTU server.</p>
4	Modbus setting	
		<p>1. Bit read area Address: P0000      2. Bit write area Address: M0000</p> <p>3. Word read area Address: P0000      4. Word write area Address: M0000</p> <p>* In the Bit read/write area Address, upper 4 digit is word address and the last digit is bit address (P00110: 0<sup>th</sup> bit of P11<sup>th</sup> word)</p>

Sequence	Procedure	Setting method
5	Writing parameter	
<ol style="list-style-type: none"> <li>1. Select [Online] – [Write Parameter] or click icon (  ).</li> <li>2. Click [OK]</li> <li>3. If writing parameter is complete after clicking [OK] button, changed parameter is applied automatically.</li> </ol>		



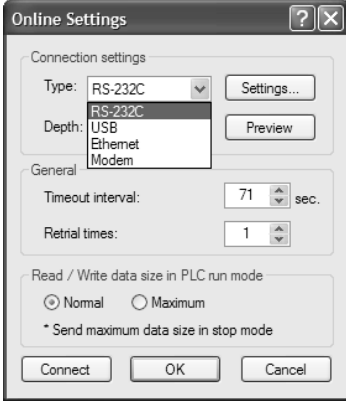

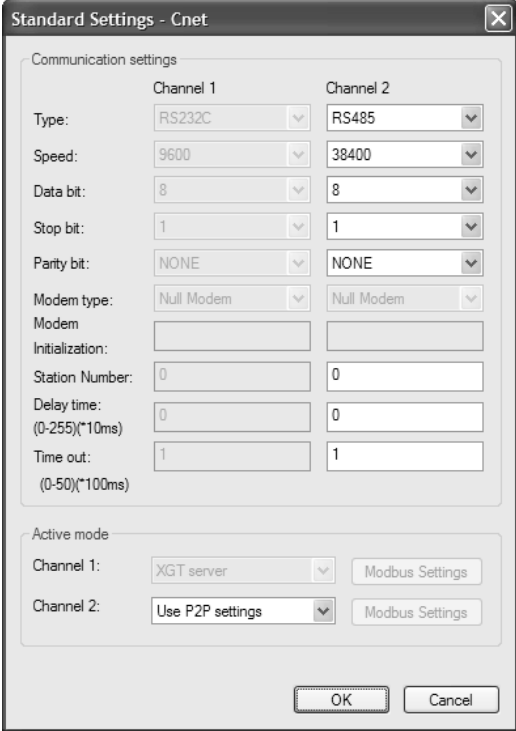

4) Setting of Modbus RTU client

Standard settings are as follows to act XBL-C41A of client as Modbus RTU client.

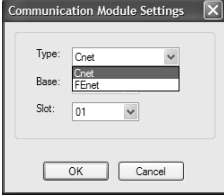
Sequence	Procedure	Setting method
1	Connection setting	
		<ol style="list-style-type: none"> <li>1. Select [Online]-[Connection settings] or click icon (  ).</li> <li>2. After setting the connection option according to user, click the 'connection'.</li> </ol>
2	Reading IO information	Select [Online]-[Read IO Information] and click icon (  ). IO information of currently mounted is shown on the project window.
3	Standard settings	
		<ol style="list-style-type: none"> <li>1. Select XBL-C41A and write standard settings to be same with [Table 2.11.1] at channel</li> <li>2. Since station setting doesn't have meaning when acting as client, set as temporary station number (0~255).</li> <li>3. When acting as client mode, active mode should be Use P2P settings.</li> </ol>

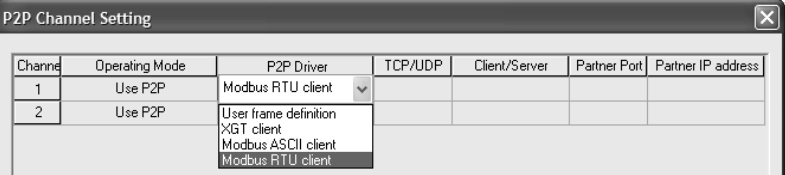
## Chapter 2 Built-in Cnet communication

After standard settings, P2P channel and P2P block should be set. Setting methods are as follows.

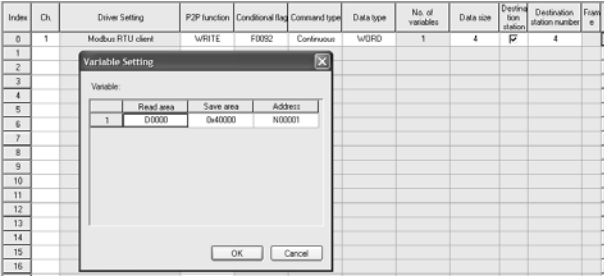

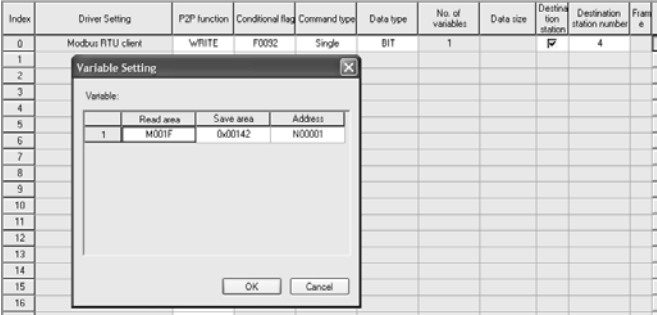
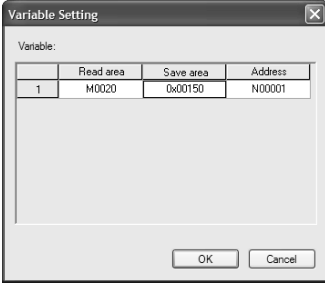
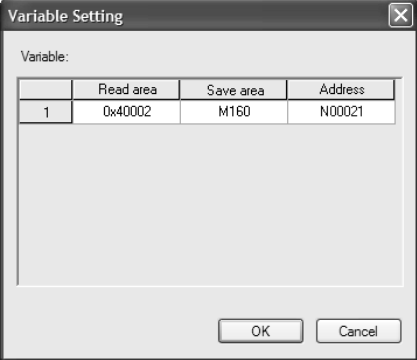

Sequence	Procedure	Setting method
1	P2P setting	Click  P2P bottom of project window.
2	Communication module setting	 <p>1. Double-click  of project window. (P2P 01 is fixed as built-in communication) 2. Select slot no. (No. 1) of client module and press OK.</p>
3	P2P channel setting	 <p>1. Double-click  of P2P 01 and set P2P driver of channel 1 as Modbus RTU client and click [OK].</p>
4		1. Double-click  of P2P 02.
5	Setting of writing operation (1)	 <p>► Write 1 word of M100 of client to M1 of server</p> <ol style="list-style-type: none"> <li>Ch.: Select ch.2 set as Modbus RTU client set in P2P channel.</li> <li>P2P function: select WRITE.</li> <li>Conditional flag: to send frame every 200ms, use flag F92.</li> <li>Command type, Data type: to write 1 word, select single and 2 byte.</li> <li>Destination station number: select station number of server.</li> <li>Setting: after setting Read area and Save area, click OK.             <ul style="list-style-type: none"> <li>(1) Read area: device address saved in the client (M100)</li> <li>(2) Save area: device address of server to save (0x40001: M1)</li> </ul> </li> </ol> <p>* If all settings are completed, color of index of channel becomes black.</p>
6	Setting of writing operation (2)	 <p>► Write 4 words from D0 of client to M2~M5 of server</p> <ol style="list-style-type: none"> <li>Ch., P2P function, conditional flag, destination station no.: same with step 5</li> <li>Command type, Data type: because of writing continuous 4words, select Continuous, WORD</li> <li>Data size: because of 4 words, input 4.</li> <li>Setting: after setting Read area and Save area, click OK.             <ul style="list-style-type: none"> <li>(1) Read area: device address saved in the client (D0)</li> <li>(2) Save area: device address of server to save (0x40002 : M2)</li> </ul> </li> </ol>

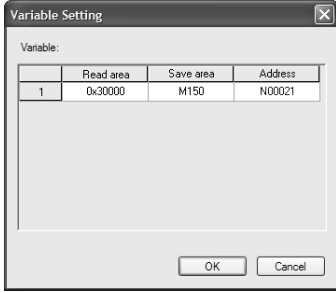
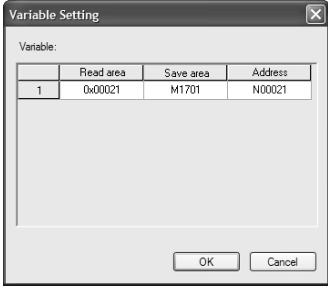
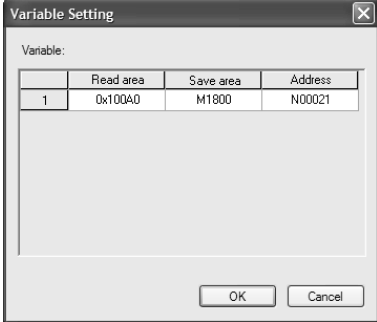
Sequence	Procedure	Setting method
7	Setting of writing operation (3)	 <p>▶ Write 15<sup>th</sup> bit of M2 to 2<sup>nd</sup> bit of M20 of server</p> <ol style="list-style-type: none"> <li>Ch., P2P function, conditional flag, destination station no.: same with step 5</li> <li>Data type: select bit</li> <li>Setting: after setting Read area and Save area, click OK.             <ol style="list-style-type: none"> <li>Read area: device address saved in the client (M1.F : 15<sup>th</sup> bit of M1)</li> <li>Save area: device address of server to save (0x00142: 2<sup>nd</sup> bit of M20)</li> </ol> </li> </ol> <p>* When inputting M1.F, it is converted into M0001F in the XG-PD.          * Device address of server is Hex value.</p>
8	Setting of writing operation (4)	 <p>▶ Write 0~15<sup>th</sup> bit of M2 to 0~15<sup>th</sup> bit of M21 of server</p> <ol style="list-style-type: none"> <li>Ch., P2P function, conditional flag, destination station no.: same with step 7</li> <li>Command type: select continuous.</li> <li>Setting: after setting Read area and Save area, click OK.             <ol style="list-style-type: none"> <li>Read area: device address saved in the client (M2.0)</li> <li>Save area: device address of server to save (0x00150)</li> </ol> </li> </ol>
9	Setting of reading operation (1)	 <p>▶ Read 1 word of M2 of server and save it at M160 of client</p> <ol style="list-style-type: none"> <li>Ch., Conditional flag, Command type, Data type, Destination station no.: same with step 5</li> <li>P2P function: select READ</li> <li>Setting: after setting Read area and Save area, click OK.             <ol style="list-style-type: none"> <li>Read area: device address saved in server (0x40002)</li> <li>Save area: device address of client to save (M0160)</li> </ol> </li> </ol>

## Chapter 2 Built-in Cnet communication

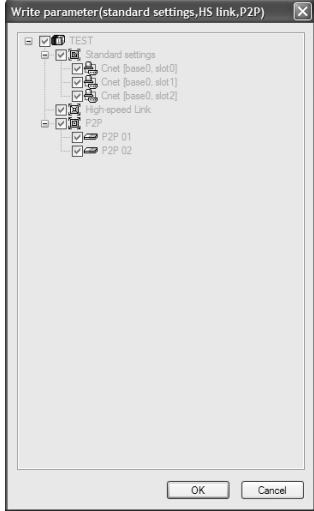
Sequence	Procedure	Setting method
10	Setting of reading operation (2)	 <p>▶ Read 4 words from P0 of server and save it at M150~M153</p> <ol style="list-style-type: none"> <li>Ch., Conditional flag, Command type, Data type, Destination station no.: same with step 6</li> <li>P2P function: select READ.</li> <li>Setting: after setting Read area and Save area, click OK.             <ol style="list-style-type: none"> <li>Read area: device address saved in server (0x30000)</li> <li>Save area: device address of client to save (M0150)</li> </ol> </li> </ol>
11	Setting of reading operation (3)	 <p>▶ Read 1<sup>st</sup> bit of P2 of server and save it at 1<sup>st</sup> bit of M170.</p> <ol style="list-style-type: none"> <li>Ch., Conditional flag, Command type, Data type, Destination station no.: same with step 7</li> <li>P2P function: select READ</li> <li>Setting: after setting Read area and Save area, click OK.             <ol style="list-style-type: none"> <li>Read area: device address saved in server (0x00021)</li> <li>Save area: device address of client to save (M170.1)</li> </ol> </li> </ol>
12	Setting of reading operation (4)	 <p>▶ Read 0<sup>th</sup> ~ 15<sup>th</sup> bit of M10 of server and save it at 0<sup>th</sup> ~ 15<sup>th</sup> of M180 of client.</p> <ol style="list-style-type: none"> <li>Ch., Conditional flag, Command type, Data type, Destination station no.: same with step 8</li> <li>P2P function: select READ</li> <li>Setting: after setting Read area and Save area, click OK.             <ol style="list-style-type: none"> <li>Read area: device address saved in server (0x100A0)</li> <li>Save area: device address of client to save (M180.0)</li> </ol> </li> </ol>

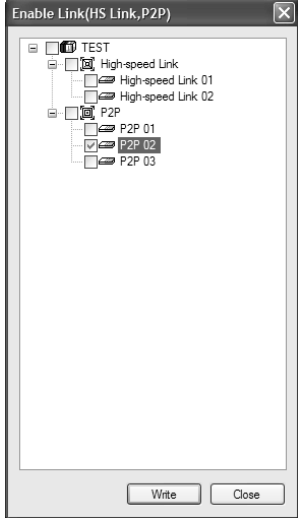

Sequence	Procedure	Setting method
13	Writing parameter	
<p>1. Select [Online] – [Write Parameter] or click icon (  ).</p> <p>2. Click [OK].</p> <p>3. If writing parameter is complete after click OK, changed parameter is applied automatically.</p>		
14	Enabling the link	
<p>1. Select [Online] – [Enable Link] or click icon (  )</p> <p>2. Click the P2P to enable and click Write.</p>		

### 2.10.4 User-defined Communication Example

When communication with device of which protocol is not supported by Cnet I/F module client, how to use user-defined communication is described in the system like [Figure 2.11.3] below

- System configuration

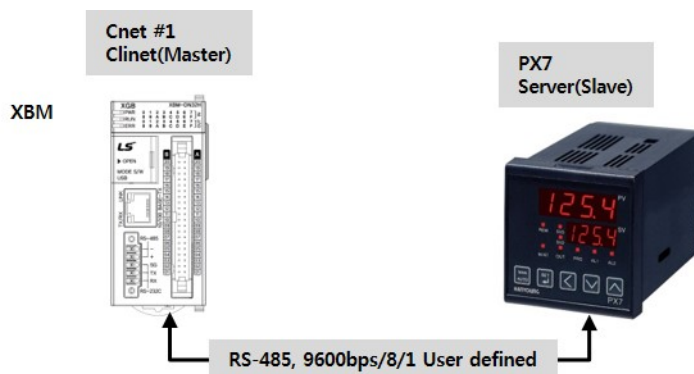

[Figure 2.11.3] User defined communication system configuration

At this example, Cnet I/F module and partner device to communicate through user defined communication system configuration are as Table below.

Device name	Main unit	XBC-DN32H	Han-Young temperature controller PX7 <sup>Note2)</sup>
	Communication module	Built-in RS-485	
Operation mode	Client		Server
Protocol	User frame definition		PC Link
Communication type	RS-485		RS-485
Communication speed	9,600		9,600
Data bit	8		8
Stop bit	1		1
Parity bit	None		None
Station no.	0		1
Delay time <sup>note1)</sup>	100ms		-
Operation	Reads present value and setting value from temperature controller every second and saves present value at MB200 and setting value at MB210.		

[User defined communication system configuration]

Note1) Delay time is set to prevent from frame error when communication with device of which response is slow in case of RS-422/485 communication. It varies according to partner device and it has 50~100ms value generally.

### 1) User definition communication frame structure

Frame structure of PC Link, communication protocol of Han-Young used in this example, is as follows.

- Frame of temperature controller is executed as ASCII character string, it can read/write defined D, I Register. There are two protocols, STD standard protocol and SUM protocol adding Check Sum to standard type and protocol is selected by parameter of temperature controller. Standard protocol is STD". It starts with first character STX (0x02) and ends with last character CR(0x0D) LF(0x0A).

The following [Table 2.11.3] and [Table 2.11.4] indicates structure of standard protocol and Sum protocol.

STX	Station no.	Command	Data	CR	LF
0x02	1~99			0x0D	0x0A

[Table 2.11.3] standard protocol structure

STX	Station no.	Command	Data	Error code	CR	LF
0x02	1~99			Check Sum	0x0D	0x0A

[Table 2.11.4] SUM protocol structure

### 2) Writing example frame

In this example, present value and setting value is saved in M device area of PLC. [Table 2.11.5] is frame requesting continuous data and [Table 2.11.6] is frame responding to request.

<b>Frame</b>	STX	Station no.	DRS	,	<b>No. of data</b>	Start address of D register	CR	LF
(Byte)	1	2	3	1	2	4	1	1

[Table 2.11.5] request frame

- **DRS**: command that request reading continuous D register value. No of data and start address of D register is necessary.
- In the example, no. of data is 2 and start address is 01.

<b>Frame</b>	STX	Station no.	DRS	,	OK	,	<b>Data 1</b>	,	<b>Data N</b>	CR	LF
<b>Size (Byte)</b>	1	2	3	1	2	1	4	1	4	1	1

[Table 2.11.6] response frame

## Chapter 2 Built-in Cnet communication



### 3) User definition communication parameter setting



#### (1) Communication standard parameter setting

For standard setting, refer to setting method when acting as P2P service of 2.10.2 and configure above system [Table 2.11.1].

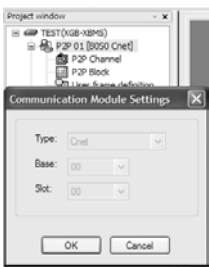
#### (2) Writing frame that requests reading data

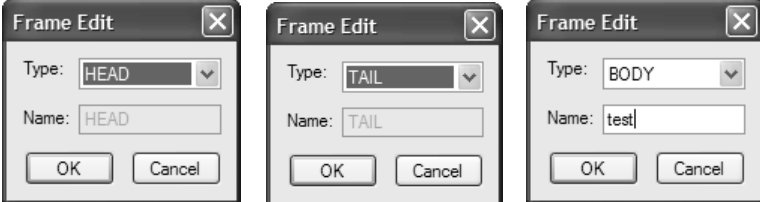
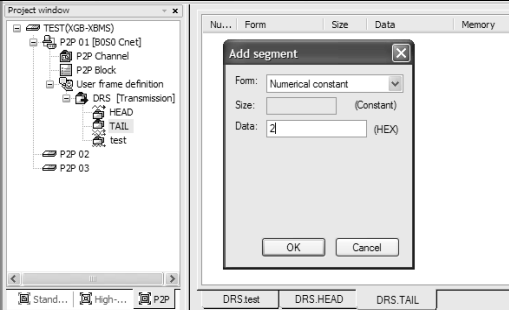
Describes how to write frame at XG-PD for user definition communication

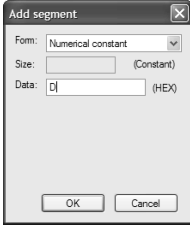
frame that requests reading data (Transmission frame)	
Sequence	Setting method
1	 <p>1. After standard settings, double-click <b>P2P 01</b> in the <b>P2P</b> window. 2. As for built-in communication, base and slot is fixed as 0. Click OK. 3. Double-click <b>P2P Channel</b> and select <b>User frame definition</b> in <b>Channel 2</b>.</p>
2	 <p>1. Click user definition frame and click right button of mouse. 2. Click 'Add Group' and input group name (DRS) and select frame type as transmission.</p>
3	 <p>1. Click 'Add Frame' and select type HEAD, TAIL, BODY and input BODY name 2. BODY's name is test here.</p>
4	 <p>1. If you double-click editor window after selecting DRS.HEAD tap at right screen, segment setting screen is created. 2. Select Numerical constant which indicates Hex as ASCII code as Form. Input Hex value 2 which indicates STX.</p>

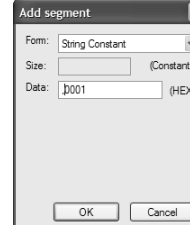
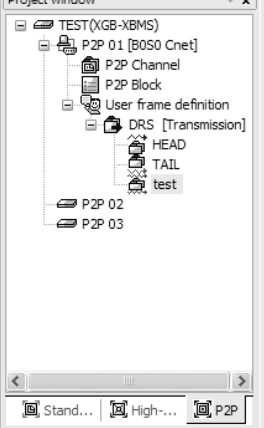
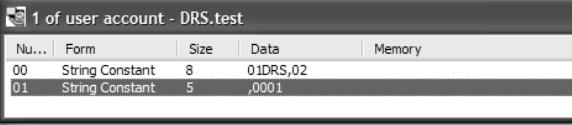
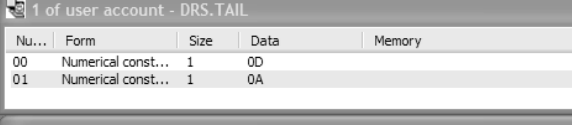
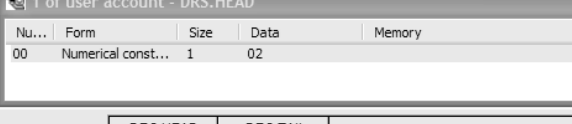
Sequence	Setting method
5	<div style="display: flex; justify-content: space-around;">   </div> <p>1. Select Numerical constant which indicates Hex as ASCII code as Form. Input Hex value D, A which indicates CR and LF.</p>
6	<div style="display: flex; justify-content: space-around;">   </div> <p>1. Double-click DRS.test tap and edit segment like the following.                  2. Write frame requesting reading data of continuous 2 areas starting first of D register of station no.1.                  3. When double-clicking editor screen and writing frame through segment edition, size of one segment is less than 10.</p>
7	<div style="display: flex;">  <div style="margin-left: 10px;">    </div> </div> <p>1. Result writing entire frame of data reading request frame.</p>

4) Writing frame to receive response frame of temperature controller

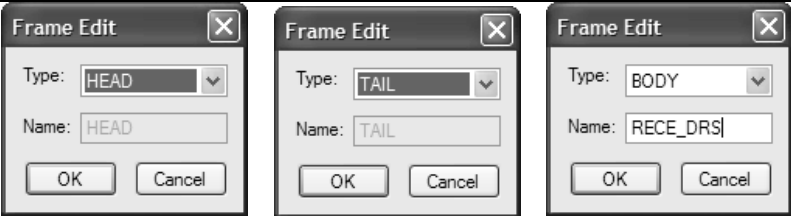
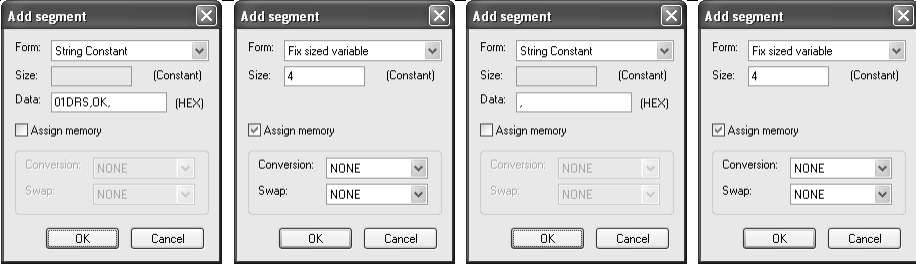
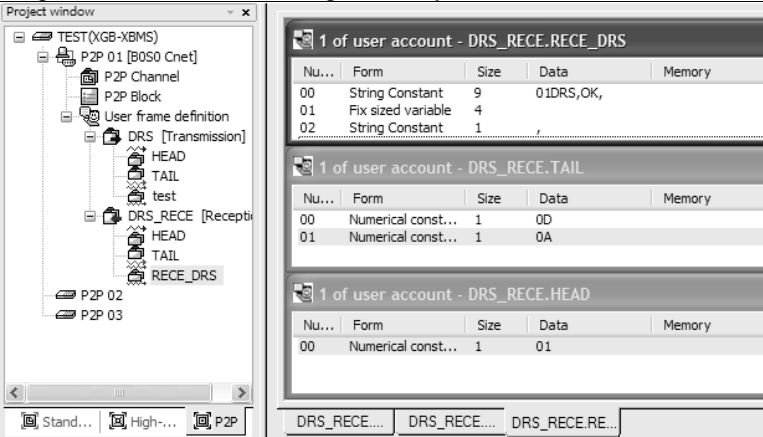
Writing response frame (Reception frame)	
Sequence	Setting method
1	 <p>1. Write like step 2 of frame that request reading data. At this time, set Frame type as reception. 2. Frame name is DRS_RECE.</p>
2	 <p>1. Click 'Add Frame' and select HEAD, TAIL, BODY as type and input BODY name. 2. BODY's name is RECE_DRS here.</p>
3	<p>1. Method writing HEAD, TAIL is same with step 4~5 of method writing frame that request reading data.</p>
4	 <p>1. To save present temperature value in MB200 and setting value in MB210, set the storage area of 1<sup>st</sup> and 2<sup>nd</sup> data as set in [Table 10.4.1]. 2. Since data size of data 1 and 2 is 4 byte, select Fix sized variable and input 4 in Size 3. To select storage area of data, check Assign memory.</p>
5	 <p>1. This is entire frame to receive response data of temperature controller.</p>

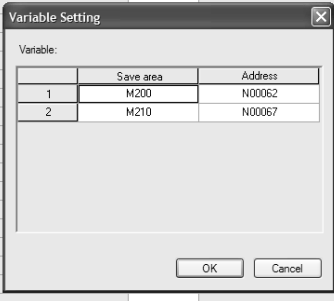

5) Writing P2P transmission/reception block

Write P2P TX/RX block as follows by using user definition communication segment written ahead.

Sequence	Setting method
1	 <ol style="list-style-type: none"> <li>1. Double-click P2P block of P2P 01.</li> <li>2. Input channel selected at P2P channel (user frame definition).</li> <li>3. In case P2P function is TX frame, select SEND. In case P2P function is RX, select RECEIVE.</li> <li>4. Conditional flag is activated when P2P function is SEND.</li> <li>5. Since it reads data every 1 second, use F93 as conditional flag.</li> <li>6. Click Setting of RX frame and set save area of current temperature and setting value.</li> </ol>
2	Execute Write Parameter and Enable Link.

6) Checking TRX data

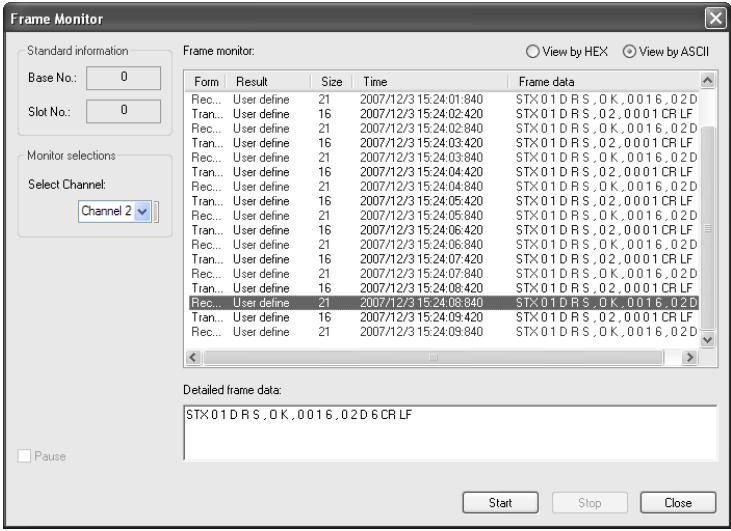
Check whether written frame is transmitted/received properly

Sequence	Setting method
1	 <ol style="list-style-type: none"> <li>1. Select [Online]-[System Diagnosis] or click icon (  )</li> <li>2. After clicking relevant module and click right button of mouse, select Status by service or frame monitor.</li> <li>3. When frame is not dealt with properly, unknown message is displayed.</li> </ol>
2	Check device area by device monitor of XG-5000.

## 2.11 Error Code

### 2.11.1 XGT Server Error Code

Error code is displayed as hex 2 byte (4 byte as ASCII code). The user can see error by frame monitor and in case of viewing by ASCII, the user can see the following error code.

Error code	Error type	Error details and causes	Example
0003	Number of blocks exceeded	Number of blocks exceeds 16 at Individual Read/Write Request	01rSS1105%MW10...
0004	Variable length error	Variable Length exceeds the max. size of 16	01rSS010D%MW100000000000 ..
0007	Data type error	Other data type than X,B,W,D,L received	01rSS0105%MK10
0011	Data error	Data length area information incorrect	01rSB05%MW10%4
		In case % is unavailable to start with	01rSS0105\$MW10
		Variable's area value wrong	01rSS0105%MW^&
		Other value is written for Bit Write than 00 or 01	01wSS0105%MX1011
0090	Monitor execution error	Unregistered monitor execution requested	
0190	Monitor execution error	Reg. No. range exceeded	
0290	Monitor reg. Error	Reg. No. range exceeded	
1132	Device memory error	Other letter than applicable device is input	
1232	Data size error	Request exceeds the max range of 60 Words to read or write at a time.	01wSB05%MW1040AA5512,..
1234	Extra frame error	Unnecessary details exist as added.	01rSS0105%MW10000
1332	Data type discordant	All the blocks shall be requested of the identical data type in the case of Individual Read/Write	01rSS0205%MW1005%MB10
1432	Data value error	Data value unavailable to convert to Hex	01wSS0105%MW10AA%5
7132	Variable request area exceeded	Request exceeds the area each device supports.	01rSS0108%MWFFFFFF

### 2.11.2 Modbus Server Error Code

Error code is displayed as hex 1 byte (2 byte as ASCII code) and indicates type of error.

Code	Error type	Error details and causes
01	Illegal Function	Function code error
02	Illegal Address	Address range exceeded
03	Illegal Data Value	Data value not allowed



### 2.11.3 P2P Client Error Code

Code	Error type	Error details and causes
01	ERR_NO_HEAD	There is no head of reception frame
02	ERR_NO_TAIL	There is no tail of reception frame
03	ERR_WRONG_BCC	BCC is not correct
04	ERR_STATION_NO	Station number of reception frame is not correct
05	ERR_WRONG_DRV_TYPE	Driver type is not correct
07	ERR_FRAME_SND	Can't send TX frame
09	ERR_NO_USE_LINKID	There is no communication module
0A	ERR_PLC_RESP_TIMEOUT	Reception frame is not received during time out setting time
0B	ERR_FRM_LENGTH	Length of reception frame is not correct
0D	ERR_ASCII_HEX_ERR	ASC-HEX conversion of reception frame is not correct
0E	ERR_RANGE_OVER	Area of device is exceeded
0F	ERR_NAK_ERR	Response of reception frame is NAK

## Appendix1 Flag List

### Appendix 1 Flag list

#### Appendix 1.1 Special Relay (F) List

Word	Bit	Variables	Function	Description
F000~1	-	_SYS_STATE	Mode and state	Indicates PLC mode and operation State.
	F0000	_RUN	Run	Run state.
	F0001	_STOP	Stop	Stop state.
	F0002	_ERROR	Error	Error state.
	F0003	_DEBUG	Debug	Debug state.
	F0004	_LOCAL_CON	Local control	Local control mode.
	F0006	_REMOTE_CON	Remote mode	Remote control mode.
	F0008	_RUN_EDIT_ST	Editing during RUN	Editing program download during RUN.
	F0009	_RUN_EDIT_CHK	Editing during RUN	Internal edit processing during RUN.
	F000A	_RUN_EDIT_DONE	Edit done during RUN	Edit is done during RUN.
	F000B	_RUN_EDIT_END	Edit end during RUN	Edit is ended during RUN.
	F000C	_CMOD_KEY	Operation mode	Operation mode changed by key.
	F000D	_CMOD_LPADT	Operation mode	Operation mode changed by local PADT.
	F000E	_CMOD_RPADT	Operation mode	Operation mode changed by Remote PADT.
	F000F	_CMOD_RLINK	Operation mode	Operation mode changed by Remote communication module.
	F0010	_FORCE_IN	Forced input	Forced input state.
	F0011	_FORCE_OUT	Forced output	Forced output state.
	F0014	_MON_On	Monitor	Monitor on execution.
	F0015	_USTOP_On	Stop	Stop by Stop function.
	F0016	_ESTOP_On	EStop	Stop by EStop function.
F0017	_CONPILE_MODE	Compile	Compile on execution.	
F0018	_INIT_RUN	Initialize	Initialization task on execution.	
F001C	_PB1	Program Code 1	Program Code 1 selected.	
F001D	_PB2	Program Code 2	Program Code 2 selected.	
F001E	_CB1	Compile Code 1	Compile Code 1 selected.	
F001F	_CB2	Compile Code2	Compile Code 2 selected.	
F002~3	-	_CNF_ER	System error	Reports heavy error state of system.
	F0021	_IO_TYER	Module Type error	Module Type does not match.
	F0022	_IO_DEER	Module detachment error	Module is detached.
	F0024	_IO_RWER	Module I/O error	Module I/O error.
	F0025	_IP_IFER	Module interface error	Special/communication module interface error.
	F0026	_ANNUM_ER	External device error	Detected heavy error in external Device.

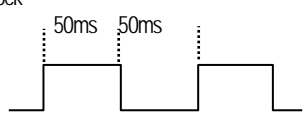
Word	Bit	Variable	Function	Description	
F002~3	F0028	_BPRM_ER	Basic parameter	Basic parameter error.	
	F0029	_IOPRM_ER	IO parameter	I/O configuration parameter error.	
	F002A	_SPPRM_ER	Special module parameter	Special module parameter is Abnormal.	
	F002B	_CPPRM_ER	Communication module parameter	Communication module parameter is abnormal.	
	F002C	_PGM_ER	Program error	Program error.	
	F002D	_CODE_ER	Code error	Program Code error.	
	F002E	_SWDT_ER	System watchdog	System watchdog operated.	
	F0030	_WDT_ER	Scan watchdog	Scan watchdog operated.	
F004	-	_CNF_WAR	System warning	Reports light error state of system.	
	F0041	_DBCK_ER	Backup error	Data backup error.	
	F0043	_ABSD_ER	Operation shutdown error	Stop by abnormal operation.	
	F0046	_ANNUM_WAR	External device error	Detected light error of external device.	
	F0048	_HS_WAR1	High speed link 1	High speed link – parameter 1 error.	
	F0049	_HS_WAR2	High speed link 2	High speed link – parameter 2 error.	
	F0054	_P2P_WAR1	P2P parameter 1	P2P – parameter 1 error.	
	F0055	_P2P_WAR2	P2P parameter 2	P2P – parameter 2 error.	
	F0056	_P2P_WAR3	P2P parameter 3	P2P – parameter 3 error.	
	F005C	_CONSTANT_ER	Constant error	Constant error.	
F009	-	_USER_F	User contact	Timer used by user.	
	F0090	_T20MS	20ms	<p>As a clock signal available at user program, it reverses On/Off every half period. Since clock signal is dealt with at the end of scan, there may be delay or distortion according to scan time. So use clock that's longer than scan time. Clock signal is Off status at the start of scan program and task program.</p> <p>_T100ms clock</p> 	
	F0091	_T100MS	100ms		
	F0092	_T200MS	200ms		
	F0093	_T1S	1s Clock		
	F0094	_T2S	2 s Clock		
	F0095	_T10S	10 s Clock		
	F0096	_T20S	20 s Clock		
	F0097	_T60S	60 s Clock		
	F0099	_On	Ordinary time On		Always On state Bit.
	F009A	_Off	Ordinary time Off		Always Off state Bit.
	F009B	_1On	1scan On	First scan On Bit.	
	F009C	_1Off	1scan Off	First scan OFF bit.	
	F009D	_STOG	Reversal	Reversal every scan.	

## Appendix1 Flag List

Word	Bit	Variable	Function	Description
F010	-	_USER_CLK	User Clock	Clock available for user setting.
	F0100	_USR_CLK0	Setting scan repeat	On/Off as much as set scan Clock 0.
	F0101	_USR_CLK1	Setting scan repeat	On/Off as much as set scan Clock 1.
	F0102	_USR_CLK2	Setting scan repeat	On/Off as much as set scan Clock 2.
	F0103	_USR_CLK3	Setting scan repeat	On/Off as much as set scan Clock 3.
	F0104	_USR_CLK4	Setting scan repeat	On/Off as much as set scan Clock 4.
	F0105	_USR_CLK5	Setting scan repeat	On/Off as much as set scan Clock 5.
	F0106	_USR_CLK6	Setting scan repeat	On/Off as much as set scan Clock 6.
F011	-	_LOGIC_RESULT	Logic result	Indicates logic results.
	F0110	_LER	operation error	On during 1 scan in case of operation error.
	F0111	_ZERO	Zero flag	On when operation result is 0.
	F0112	_CARRY	Carry flag	On when carry occurs during operation.
	F0113	_ALL_Off	All output OFF	On in case that all output is Off.
F012	-	_CMP_RESULT	Comparison result	Indicates the comparison result.
	F0120	_LT	LT flag	On in case of "less than".
	F0121	_LTE	LTE flag	On in case of "equal or less than".
	F0122	_EQU	EQU flag	On in case of "equal".
	F0123	_GT	GT flag	On in case of "greater than".
	F0124	_GTE	GTE flag	On in case of "equal or greater than".
F014	-	_FALS_NUM	FALS no.	Indicates FALS no.
F015	-	_PUTGET_ERR0	PUT/GET error 0	Main base Put / Get error.
F023	-	_PUTGET_NDR0	PUT/GET end 0	Main base Put/Get end.
F044	-	_CPU_TYPE	CPU Type	Indicates information for CPU Type.
F045	-	_CPU_VER	CPU version	Indicates CPU version.
F046	-	_OS_VER	OS version	Indicates OS version.
F048	-	_OS_DATE	OS date	Indicates OS distribution date.
F050	-	_SCAN_MAX	Max. scan time	Indicates max. scan time.
F051	-	_SCAN_MIN	Min. scan time	Indicates min. scan time.
F052	-	_SCAN_CUR	Current scan time	Current scan time.
F0053	-	_MON_YEAR	Month/year	Clock data (month/year) Supported when using RTC option module
F0054	-	_TIME_DAY	Hour/date	Clock data (hour/date) Supported when using RTC option module
F0055	-	_SEC_MIN	Second/minute	Clock data (Second/minute) Supported when using RTC option module
F0056	-	_HUND_WK	Hundred year/week	Clock data (Hundred year/week) Supported when using RTC option module
F057	-	_FPU_INFO	N/A	-
	F0570	_FPU_LFLAG_I	N/A	-
	F0571	_FPU_LFLAG_U	N/A	-
	F0572	_FPU_LFLAG_O	N/A	-
	F0573	_FPU_LFLAG_Z	N/A	-

Word	Bit	Variable	Function	Description
	F0574	_FPU_LFLAG_V	N/A	-
	F057A	_FPU_FLAG_I	N/A	-
	F057B	_FPU_FLAG_U	N/A	-
	F057C	_FPU_FLAG_O	N/A	-
	F057D	_FPU_FLAG_Z	N/A	-
	F057E	_FPU_FLAG_V	N/A	-
	F057F	_FPU_FLAG_E	Irregular input	Reports in case of irregular input.
F058	-	_ERR_STEP	Error step	Saves error step.
F060	-	_REF_COUNT	Refresh	Increase when module Refresh.
F062	-	_REF_OK_CNT	Refresh OK	Increase when module Refresh is normal.
F064	-	_REF_NG_CNT	Refresh NG	Increase when module Refresh is Abnormal.
F066	-	_REF_LIM_CNT	Refresh Limit	Increase when module Refresh is abnormal (Time Out).
F068	-	_REF_ERR_CNT	Refresh Error	Increase when module Refresh is Abnormal.
F070	-	_MOD_RD_ERR_CNT	-	-
F072	-	_MOD_WR_ERR_CNT	-	-
F074	-	_CA_CNT	-	-
F076	-	_CA_LIM_CNT	-	-
F078	-	_CA_ERR_CNT	-	-
F080	-	_BUF_FULL_CNT	Buffer Full	Increase when CPU internal buffer is full.
F082	-	_PUT_CNT	Put count	Increase when Put count.
F084	-	_GET_CNT	Get count	Increase when Get count.
F086	-	_KEY	Current key	indicates the current state of local key.
F088	-	_KEY_PREV	Previous key	indicates the previous state of local key
F090	-	_IO_TYER_N	Mismatch slot	Module Type mismatched slot no.
F091	-	_IO_DEER_N	Detach slot	Module detached slot no.
F093	-	_IO_RWER_N	RW error slot	Module read/write error slot no.
F094	-	_IP_IFER_N	IF error slot	Module interface error slot no.
F096	-	_IO_TYER0	Module Type 0 error	Main base module Type error.

## Appendix1 Flag List

Word	Bit	Variable	Function	Description
F104	-	_IO_DEER0	Module Detach 0 error	Main base module Detach error.
F120	-	_IO_RWER0	Module RW 0 error	Main base module read/write error.
F128	-	_IO_IFER_0	Module IF 0 error	Main base module interface error.
F140	-	_AC_FAIL_CNT	Power shutdown times	Saves the times of power shutdown.
F142	-	_ERR_HIS_CNT	Error occur times	Saves the times of error occur.
F144	-	_MOD_HIS_CNT	Mode conversion times	Saves the times of mode conversion.
F146	-	_SYS_HIS_CNT	History occur times	Saves the times of system history.
F148	-	_LOG_ROTATE	N/A	
F150	-	_BASE_INFO0	Slot information 0	Main base slot information.
F200	-	_USER_WRITE_F	Available contact point	Contact point available in program.
	F2000	_RTC_WR	RTC RW	Data write and read in RTC.
	F2001	_SCAN_WR	Scan WR	Initializing the value of scan.
	F2002	_CHK_ANC_ERR	Request detection of external serious error	Request detection of external error.
	F2003	_CHK_ANC_WAR	Request detection of external slight error (warning)	Request detection of external slight error (warning).
F201	-	_USER_STAUS_F	User contact point	User contact point.
	F2010	_INIT_DONE	Initialization completed	Initialization complete displayed.
F202	-	_ANC_ERR	Display information of external serious error	Display information of external serious error
F203	-	_ANC_WAR	Display information of external slight error (warning)	Display information of external slight error (warning)
F210	-	_MON_YEAR_DT	Month/year	Clock data (month/year) Supported when using RTC option module
F211	-	_TIME_DAY_DT	Hour/date	Clock data (hour/date) Supported when using RTC option module
F212	-	_SEC_MIN_DT	Second/minute	Clock data (Second/minute) Supported when using RTC option module
F213	-	_HUND_WK_DT	Hundred year/week	Clock data (Hundred year/week) Supported when using RTC option module

## Appendix 1.2 Communication Relay (L) List

Here describes data link communication relay(L).

### (1) High-speed Link 1

Device	Keyword	Type	Description
L00000	_HS1_RLINK	Bit	<p>High speed link parameter 1 normal operation of all station</p> <p>Indicates normal operation of all station according to parameter set in High speed link, and On under the condition as below.</p> <ol style="list-style-type: none"> <li>1. In case that all station set in parameter is RUN mode and no error,</li> <li>2. All data block set in parameter is communicated normally, and</li> <li>3. The parameter set in each station itself is communicated normally.</li> </ol> <p>Once RUN_LINK is On, it keeps On unless stopped by LINK_DISABLE.</p>
L00001	_HS1_LTRBL	Bit	<p>Abnormal state after _HS1RLINK On</p> <p>In the state of _HSmRLINK flag On, if communication state of the station set in the parameter and data block is as follows, this flag shall be On.</p> <ol style="list-style-type: none"> <li>1. In case that the station set in the parameter is not RUN mode, or</li> <li>2. There is an error in the station set in the parameter, or</li> <li>3. The communication state of data block set in the parameter is not good.</li> </ol> <p>LINK TROUBLE shall be On if the above 1, 2 &amp; 3 conditions occur, and if the condition return to the normal state, it shall be OFF again.</p>
L00020 ~ L0005F	_HS1_STATE[k] (k = 00~63)	Bit Array	<p>High speed link parameter 1, K block general state</p> <p>Indicates the general state of communication information for each data block of setting parameter.</p> <p>_HS1_STATE[k] = HS1MOD[k]&amp;_HS1TRX[k]&amp;(~_HS1_ERR[k])</p>
L00060 ~ L0009F	_HS1_MOD[k] (k = 00~63)	Bit Array	<p>High speed link parameter 1, k block station RUN operation mode</p> <p>Indicates operation mode of station set in K data block of parameter.</p>
L00100 ~ L0013F	_HS1_TRX[k] (k = 00~63)	Bit Array	<p>Normal communication with High speed link parameter 1, k block station</p> <p>Indicates if communication state of Kdata of parameter is communicated smoothly according to the setting.</p>
L00140 ~ L0017F	_HS1_ERR[k] (k = 00~63)	Bit Array	<p>High speed link parameter 1, K block station operation error mode</p> <p>Indicates if the error occurs in the communication state of k data block of parameter.</p>
L00180 ~ L0021F	_HS1_SETBLOCK[k]	Bit Array	<p>High speed link parameter 1, K block setting</p> <p>Indicates whether or not to set k data block of parameter.</p>

## Appendix1 Flag List

(2) High-speed Link 2~5

High speed link No. 1 ~ 5

Block Number	Address	Note
2	L0260~L047F(extension)	For each block flags, refer to the table on the preceding page.
3	L0580~L079F(extension)	
4	L0840~L104F(high extension)	
5	L1090~L129F(high extension)	

k that is the block number indicates the information of 64 blocks in the range of 00~63 through 4 words; 16 per 1 word. For example, the mode information(\_HS1MOD) indicates the information of the block 0~15 in L0006; the information of block 16~31, 32~47, 48~63 in L0007, L0008, L0009. Accordingly, the mode information of block No. 55 is indicated in L00097.



(3) P2P Flag

P2P Parameter:1~3, P2P block: 0~31

Device	Keyword	Type	Description
L5120	_P2P1_NDR00	Bit	Indicates P2P parameter 1, 0 Block service normal end.
L5121	_P2P1_ERR00	Bit	Indicates P2P parameter 1, 0 Block service abnormal end.
L513	_P2P1_STATUS00	Word	Indicates error code in case of P2P parameter 1, 0 Block service abnormal end.
L514	_P2P1_SVCCNT00	DWord	Indicates P2P parameter 1, 0 Block service normal count.
L516	_P2P1_ERRCNT00	DWord	Indicates P2P parameter 1, 0 Block service abnormal count.
L5180	_P2P1_NDR01	Bit	P2P parameter 1, 1 Block service normal end.
L5181	_P2P1_ERR01	Bit	P2P parameter 1, 1 Block service abnormal end.
L519	_P2P1_STATUS01	Word	Indicates error code in case of P2P parameter 1, 1 Block service abnormal end.
L520	_P2P1_SVCCNT01	DWord	Indicates P2P parameter 1, 1 Block service normal count.
L522	_P2P1_ERRCNT01	DWord	Indicates P2P parameter 1, 1 Block service abnormal count.

In terms of P2P parameter No.1 block, a total of 32 blocks from No.0 to No.31 exist. The parameters of each block have the same size and display function as the above table.

P2P Number	L Address	Note
1	L05120~L0703F(Cnet)	For the saving area parameters of each block, refer to the above table.
2	L07040~L0895F(Enet)	
3	L08960~L1087F(Extension)	
4	L10880~L1279F(Extension)	
5	L12800~L1471F(HighExtension)	
6	L14720~L1663F(HighExtension)	

## Appendix1 Flag List

### (4) Network Register (N) List

Here describes Network Register for communication (N). P2P parameter: 1~6, P2P block: 0~31

Device	Keyword	Type	Description
N000	_P1B00SN	Word	Saves another station no. of P2P parameter 1, 00 block.
N0001~0004	_P1B00RD1	Device Structure	Saves area device 1 to read P2P parameter 1, 00 block.
N0005	_P1B00RS1	Word	Saves area size 1 to read P2P parameter 1, 00block.
N0006~0009	_P1B00RD2	Device Structure	Saves area device 2 to read P2P parameter 1, 00 block.
N0010	_P1B00RS2	Word	Saves area size 2 to read P2P parameter 1, 00 block.
N0011~0014	_P1B00RD3	Device Structure	Saves area device 3 to read P2P parameter 1, 00 block.
N0015	_P1B00RS3	Word	Saves area size 3 to read P2P parameter 1, 00 block.
N0016~0019	_P1B00RD4	Device Structure	Saves area device 4 to read P2P parameter 1, 00 block.
N0020	_P1B00RS4	Word	Saves area size 4 to read P2P parameter 1, 00 block.
N0021~0024	_P1B00WD1	Device Structure	Saves area device 1 to save P2P parameter 1, 00 block.
N0025	_P1B00WS1	Word	Saves area size 1 to save P2P parameter 1, 00 block.
N0026~0029	_P1B00WD2	Device Structure	Saves area device 2 to save P2P parameter 1, 00 block.
N0030	_P1B00WS2	Word	Saves area size 2 to save P2P parameter 1, 00 block.
N0031~0034	_P1B00WD3	Device Structure	Saves area device 3 to save P2P parameter 1, 00 block.
N0035	_P1B00WS3	Word	Saves area size 3 to save P2P parameter 1, 00block.
N0036~0039	_P1B00WD4	Device Structure	Saves area device 4 to save P2P parameter 1, 00 block.
N0040	_P1B00WS4	Word	Saves area size 4 to save P2P parameter 1, 00 block.
N0041	_P1B01SN	Word	Saves another station no. of P2P parameter 1, 01 block.
N0042~0045	_P1B01RD1	Device Structure	Saves area device 1 to read P2P parameter 1, 01 block.
N0046	_P1B01RS1	Word	Saves area size 1 to read P2P parameter 1, 01 block.
N0047~0050	_P1B01RD2	Device Structure	Saves area device 2 to read P2P parameter 1, 01 block.
N0051	_P1B01RS2	Word	Saves area size 2 to read P2P parameter 1, 01 block.
N0052~0055	_P1B01RD3	Device Structure	Saves area device 3 to read P2P parameter 1, 01 block.
N0056	_P1B01RS3	Word	Saves area size 3 to read P2P parameter 1, 01 block.

N0057~0060	_P1B01RD4	Device Structure	Saves area device 4 to read P2P parameter 1, 01 block.
N0061	_P1B01RS4	Word	Saves area size 4 to read P2P parameter 1, 01 block.
N0062~0065	_P1B01WD1	Device Structure	Saves area device 1 to save P2P parameter 1, 01 block.
N0066	_P1B01WS1	Word	Saves area size 1 to save P2P parameter 1, 01 block.
N0067~0070	_P1B01WD2	Device Structure	Saves area device 2 to save P2P parameter 1, 01 block.
N0071	_P1B01WS2	Word	Saves area size 2 to save P2P parameter 1, 01 block.
N0072~0075	_P1B01WD3	Device Structure	Saves area device 3 to save P2P parameter 1, 01 block.
N0076	_P1B01WS3	Word	Saves area size 3 to save P2P parameter 1, 01 block.
N0077~0080	_P1B01WD4	Device Structure	Saves area device 4 to save P2P parameter 1, 01 block.
N0081	_P1B01WS4	Word	Saves area size 4 to save P2P parameter 1, 01 block.

A total of 32 blocks from No.0 to No.31 exist per P2P of No.1 to No.6. The saving parameters of each block have the same size and display function as the above table.

P2P Number	L Address	Note
1	N0000~N1311(Cnet)	For the saving area parameters of each block, refer to the above table.
2	N1312~N2623(Enet)	
3	N2624~N3935(Extension)	
4	N3936~N5247(Extension)	
5	N5248~N6559(HighExtension)	
6	N6560~N7872(HighExtension)	

**Notice**

- (1) When you set P2P parameters through XG5000, N area is automatically set up.
- (2) The N area is the flash area so it cannot be used as the internal device. (Cannot write)

## Appendix1 Flag List

### (5) ASCII(American National Standard Code for Information Interchange)

ASCII		Value	ASCII		Value	ASCII		Value	ASCII		Value
HEX	DEC		HEX	DEC		HEX	DEC		HEX	DEC	
00	000	NULL	40	064	@	20	032	(space)	60	096	`
01	001	SOH	41	065	A	21	033	!	61	097	a
02	002	STX	42	066	B	22	034	"	62	098	b
03	003	ETX	43	067	C	23	035	#	63	099	c
04	004	EQT	44	068	D	24	036	\$	64	100	d
05	005	ENQ	45	069	E	25	037	%	65	101	e
06	006	ACK	46	070	F	26	038	&	66	102	f
07	007	BEL	47	071	G	27	039	'	67	103	g
08	008	BS	48	072	H	28	040	(	68	104	h
09	009	HT	49	073	I	29	041	)	69	105	i
0A	010	LF	4A	074	J	2A	042	*	6A	106	j
0B	011	VT	4B	075	K	2B	043	+	6B	107	k
0C	012	FF	4C	076	L	2C	044	,	6C	108	l
0D	013	CR	4D	077	M	2D	045	-	6D	109	m
0E	014	SO	4E	078	N	2E	046	.	6E	110	n
0F	015	SI	4F	079	O	2F	047	/	6F	111	o
10	016	DLE	50	080	P	30	048	0	70	112	p
11	017	DC1	51	081	Q	31	049	1	71	113	q
12	018	DC2	52	082	R	32	050	2	72	114	r
13	019	DC3	53	083	S	33	051	3	73	115	s
14	020	DC4	54	084	T	34	052	4	74	116	t
15	021	NAK	55	085	U	35	053	5	75	117	u
16	022	SYN	56	086	V	36	054	6	76	118	v
17	023	ETB	57	087	W	37	055	7	77	119	w
18	024	CAN	58	088	X	38	056	8	78	120	x
19	025	EM	59	089	Y	39	057	9	79	121	y
1A	026	SUB	5A	090	Z	3A	058	:	7A	122	z
1B	027	ESC	5B	091	[	3B	059	;	7B	123	{
1C	028	FS	5C	092	\	3C	060	<	7C	124	
1D	029	GS	5D	093	]	3D	061	=	7D	125	}
1E	030	RS	5E	094	^	3E	062	>	7E	126	~
1F	031	US	5F	095	_	3F	063	?	7F	127	□



## Appendix 2 Dimension (Unit : mm)

- (1) CPU Type  
- XBM-DN32H

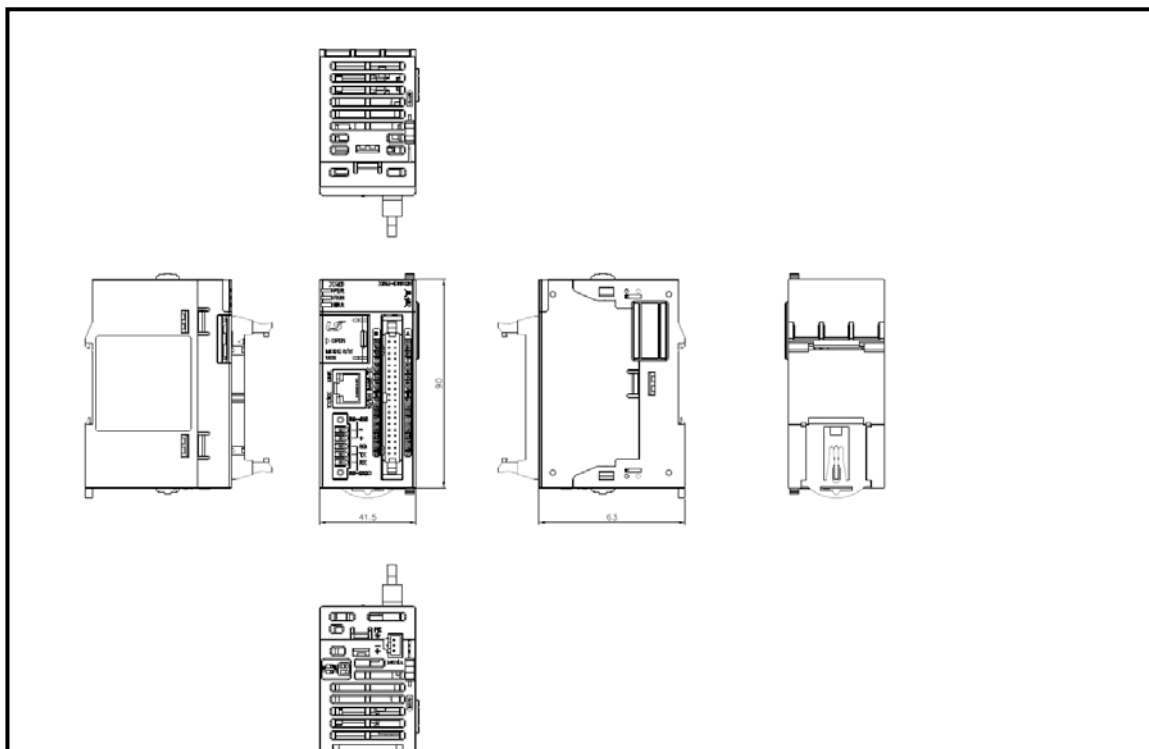

- (2) Extension I/O module  
- XBE-DC32A, XBE-TR32A

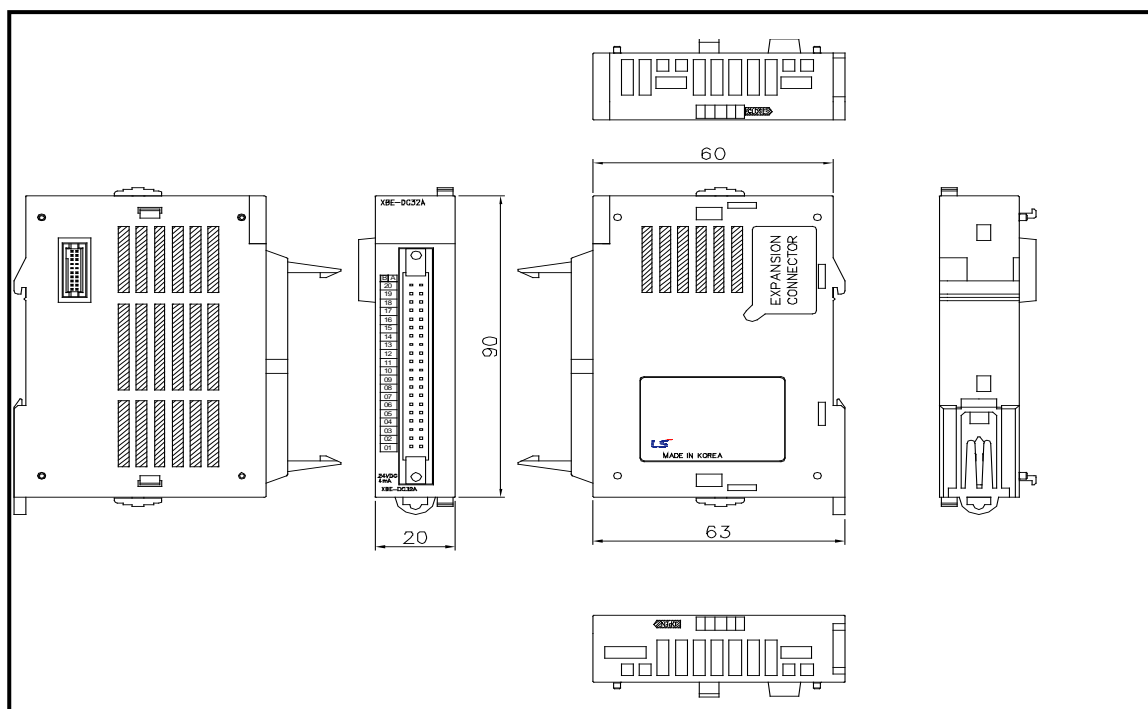

- XBE-RY16A

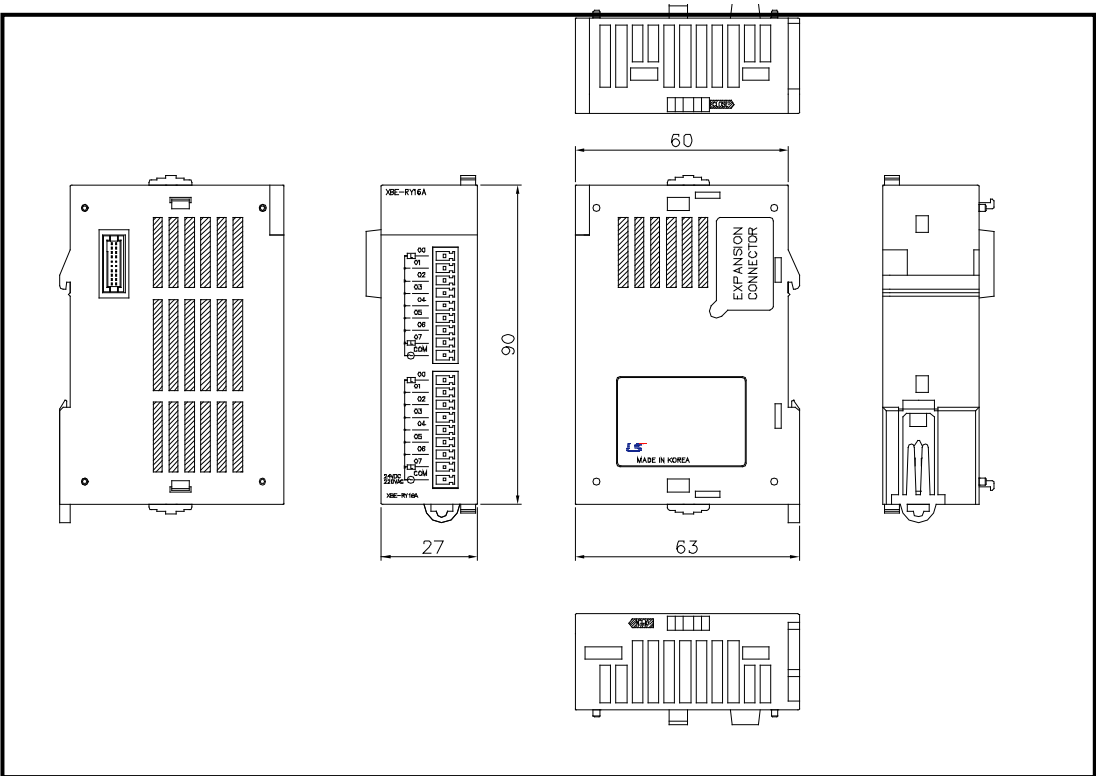

- XBE-DC08A, XBE-DC16A, XBE-TN08A, XBE-TN16A

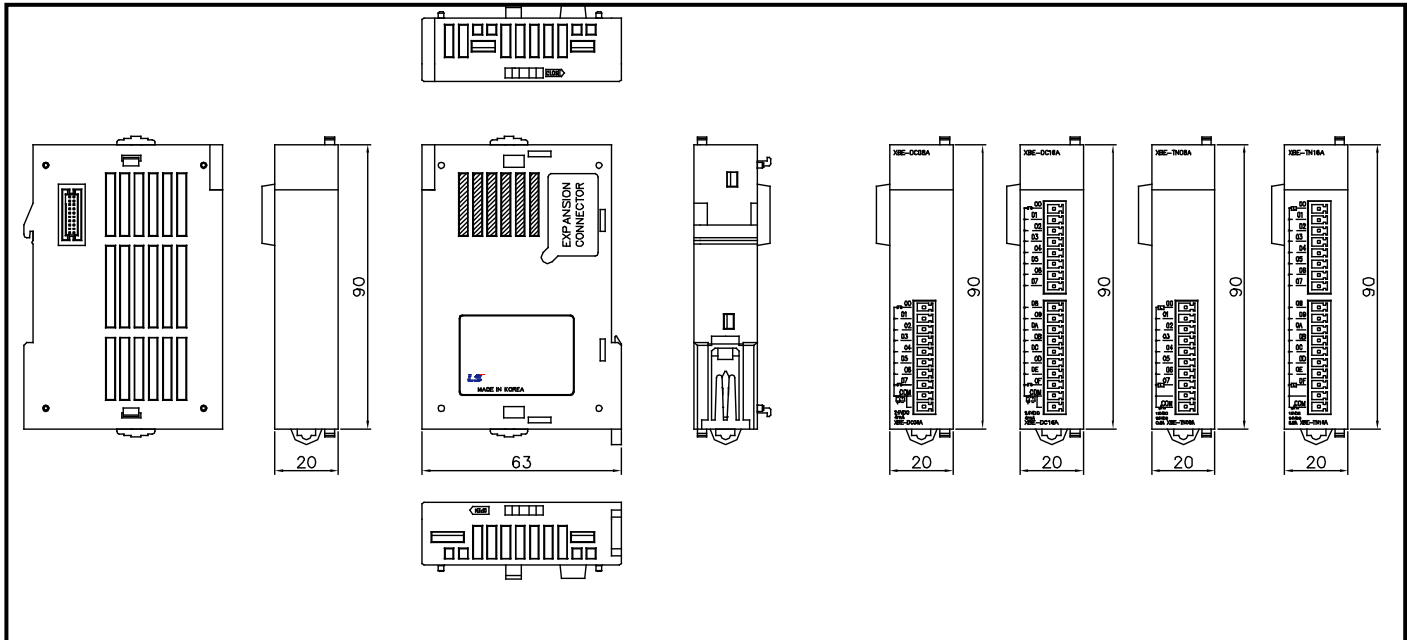

# Appendix2 Dimension

- XBE-DR16A, XBE-RY08A

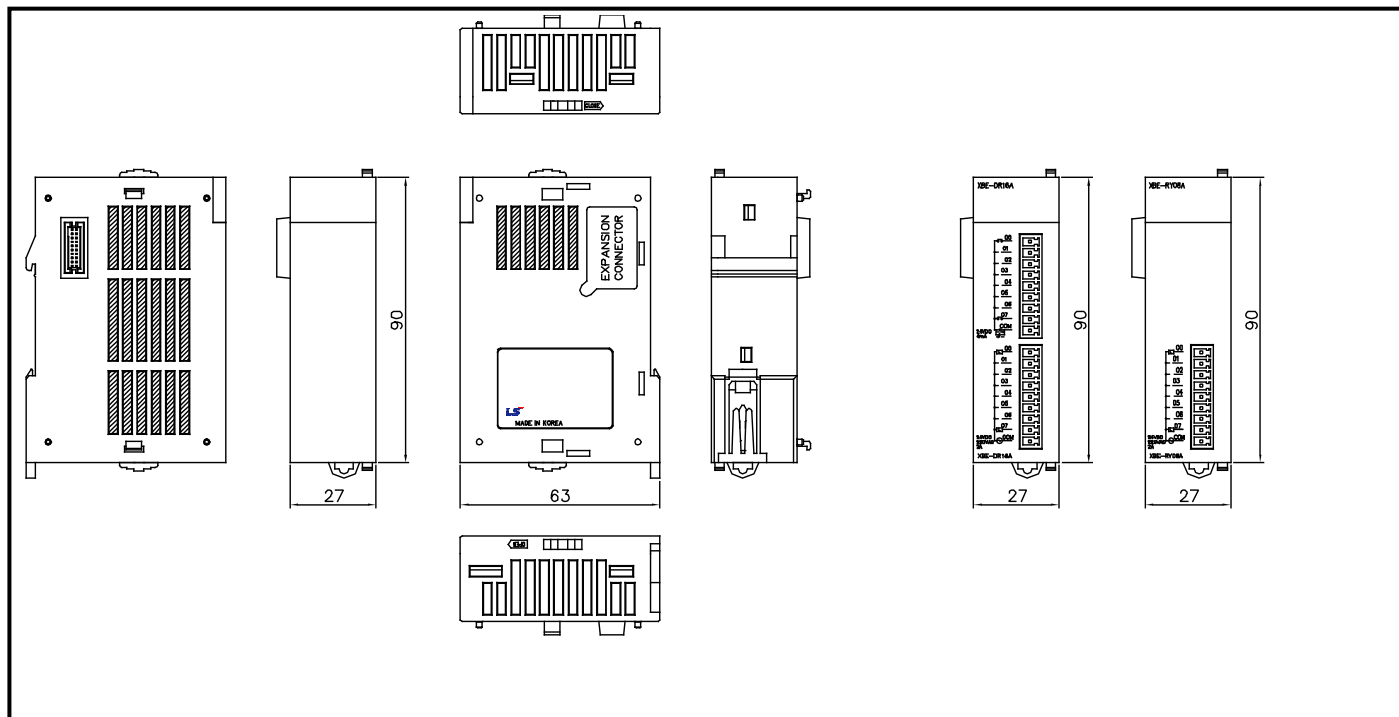



(4) Extension Cnet I/F Module

. XBL-C41A, XBL-C21A

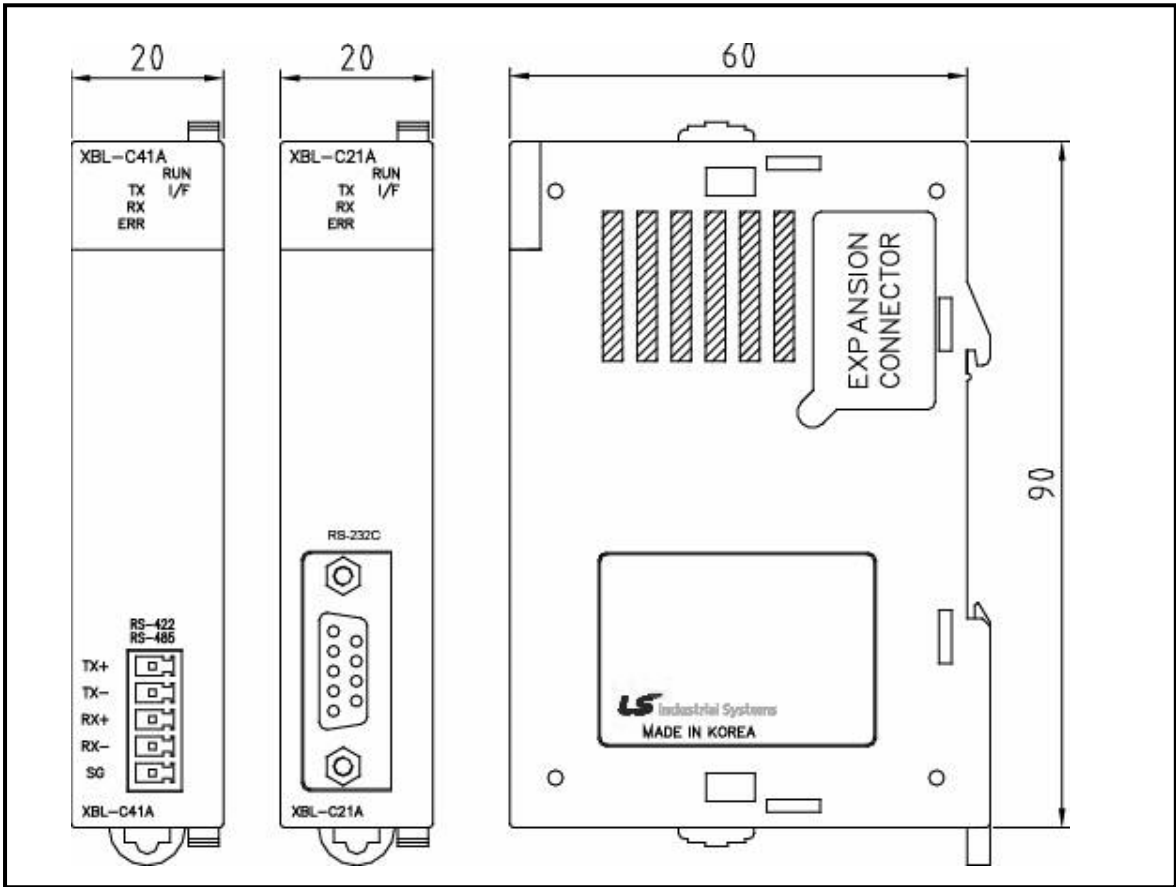

## Appendix 3 Instruction List

### Appendix 3.1 Classification of Instructions

Classification	Instructions	Details	Remarks
Basic Instructions	Contact Point Instruction	LOAD, AND, OR related Instructions	
	Unite Instruction	AND LOAD, OR LOAD, MPUSH, MLOAD, MPOP	
	Reverse Instruction	NOT	
	Master Control Instruction	MCS, MCSCLR	
	Output Instruction	OUT, SET, RST, 1 Scan Output Instruction, Output Reverse Instruction (FF)	
	Sequence/Last-input Preferred Instruction	Step Control Instruction ( SET Sxx.xx, OUT Sxx.xx )	
	End Instruction	END	
	Non-Process Instruction	NOP	
	Timer Instruction	TON, TOFF, TMR, TMON, TRTG	
	Counter Instruction	CTD, CTU, CTUD, CTR	
Application Instructions	Data Transfer Instruction	Transfers specified Data, Group, String	4/8/64 Bits available
	Conversion Instruction	Converts BIN/BCD of specified Data & Group	4/8 Bits available
	Data Type Conversion Instruction	Converts Integer/Real Number	
	Output Terminal Compare Instruction	Saves compared results in special relay	Compare to Unsigned
	Input Terminal Compare Instruction	Saves compared results in BR. Compares Real Number, String & Group. Compares 3 Operands	Compare to Signed
	Increase/Decrease Instruction	Increases or decreases specified data 1 by 1	4/8 Bits available
	Rotate Instruction	Rotates specified data to the left and right, including Carry	4/8 Bits available
	Move Instruction	Moves specified data to the left and right, word by word, bit by bit	4/8 Bits available
	Exchange Instruction	Exchanges between devices, higher & lower byte, group data	
	BIN Operation Instruction	Addition, Subtraction, Multiplication & Division for Integer/ Real Number, Addition for String, Addition & Subtraction for Group	
	BCD Operation Instruction	Addition, Subtraction, Multiplication, Division.	
	Logic Operation Instruction	Logic Multiplication, Logic Addition, Exclusive OR, Exclusive NOR, Group Operation	
	System Instruction	Error Display, WDT Initialize, Output Control, Operation Stop, etc.	
	Data Process Instruction	Encode, Decode, Data Disconnect/Connect, Search, Align, Max., Min., Total, Average, etc.	
	Data Table Process Instruction	Data Input/ Output of Data Table	
	String Process Instruction	String related Convert, Comment Read, String Extract, ASCII Convert, HEX Convert, String Search, etc.	
	Special Function Instruction	Trigonometric Function, Exponential/Log Function, Angle/ Radian Convert, etc.	
	Data Control Instruction	Max/Min Limit Control, Dead-zone Control, Zone Control	
Time related Instruction	Date Time Data Read/Write, Time Data Adjust & Convert		
Diverge Instruction	JMP, CALL		

Loop Instruction	FOR/NEXT/BREAK	
Flag related Instruction	Carry Flag Set/Reset, Error Flag Clear	
Special/Communication related Instruction	Data Read/Write by BUSCON Direct Access	
Interrupt related Instruction	Interrupt Enable/Disable	
Sign Reverse Instruction	Reverse Integer/Real Signs, Absolute Value Operation	

## Appendix 3.2 Basic Instructions

### (1) Contact-point instruction

Classification	Designations	Symbol	Description	Support	
				XGK	XGB
Contact Point	LOAD		A Contact Point Operation Start	○	○
	LOAD NOT		B Contact Point Operation Start	○	○
	AND		A Contact Point Series-Connected	○	○
	AND NOT		B Contact Point Series-Connected	○	○
	OR		A Contact Point Parallel-Connected	○	○
	OR NOT		B Contact Point Parallel-Connected	○	○
	LOADP		Positive Convert Detected Contact Point	○	○
	LOADN		Negative Convert Detected Contact Point	○	○
	ANDP		Positive Convert Detected Contact Point Series-Connected	○	○
	ANDN		Negative Convert Detected Contact Point Series-Connected	○	○
	ORP		Positive Convert Detected Contact Point Parallel-Connected	○	○
	ORN		Negative Convert Detected Contact Point Parallel-Connected	○	○

### (2) Union instruction

Classification	Designations	Symbol	Description	Support	
				XGK	XGB
Unite	AND LOAD		A,B Block Series-Connected	○	○
	OR LOAD		A,B Block Parallel-Connected	○	○
	MPUSH		Operation Result Push up to present	○	○
	MLOAD		Operation Result Load Previous to Diverge Point	○	○
	MPOP		Operation Result Pop Previous to Diverge Point	○	○

### Appendix 3 Instruction List

(3) reversion instruction

Classification	Designations	Symbol	Description	Support	
				XGK	XGB
Reverse	NOT	— * —	Previous Operation results Reverse	○	○

(4) Master Control instruction

Classification	Designations	Symbol	Description	Support	
				XGK	XGB
Master Control	MCS	— MCS n —	Master Control Setting (n:0~7)	○	○
	MCCLR	— MCS n —	Master Control Setting (n:0~7)	○	○

(5) Output instruction

Classification	Designations	Symbol	Description	Support	
				XGK	XGB
Output	OUT	— ( ) —	Operation Results Output	○	○
	OUT NOT	— ( / ) —	Operation Results Reverse Output	○	○
	OUTP	— ( P ) —	1 Scan Output if Input Condition rises	○	○
	OUTN	— ( N ) —	1 Scan Output if Input Condition falls	○	○
	SET	— ( S ) —	Contact Point Output On kept	○	○
	RST	— ( R ) —	Contact Point Output Off kept	○	○
	FF	— FF D —	Output Reverse if Input Condition rises	○	○

(6) Sequence/Last-input instruction

Classification	Designations	Symbol	Description	Support	
				XGK	XGB
Step Control	SET S	— S <sup>Sxx.xx</sup> ( S ) —	Sequence Control	○	○
	OUT S	— ( ) <sup>Sxx.xx</sup> —	Last-input Preferred	○	○

(7) End instruction

Classification	Designations	Symbol	Description	Support	
				XGK	XGB
End	END	— END —	Program End	○	○

(8) Non-process instruction

Classification	Designations	Symbol	Description	Support	
				XGK	XGB
Non-Process	NOP	Ladder not displayed	Non-process Instruction, used in Nimonic	○	○

(9) Timer instruction

Classification	Designations	Symbol	Description	Support	
				XGB	XGB
Timer	TON			O	O
	TOFF			O	O
	TMR			O	O
	TMON			O	O
	TRTG			O	O

(10) Counter instruction

Classification	Designations	Symbol	Description	Support	
				XGB	XGB
카운터	CTD			O	O
	CTU			O	O
	CTUD			O	O
	CTR			O	O

### Appendix 3.3 Data transfer instruction

(1) Data transfer instruction

Classification	Designations	Symbol	Description	Support	
				XGK	XGB
16 bits Transfer	MOV		(S) → (D)	○	○
	MOV4P				
32 bits Transfer	DMOV		(S+1,S) → (D+1,D)	○	○
	DMOV4P				
Short Real Number Transfer	RMOV		(S+1,S) → (D+1,D)	○	○
	RMOV4P				
Long Real Number Transfer	LMOV		(S+3,S+2,S+1,S) → (D+3,D+2,D+1,D)	○	○
	LMOV4P				
4 bits Transfer	MOV4			○	○
	MOV4P				
8 bits Transfer	MOV8			○	○
	MOV8P				
1's complement Transfer	CMOV		1's complement (S) → (D)	○	○
	CMOV4P				
	DCMOV		1's complement (S+1,S) → (D+1,D)	○	○
	DCMOV4P				
16 bits Group Transfer	GMOV			○	○
	GMOV4P				
Multiple Transfer	FMOV			○	○
	FMOV4P				
	GBMOV4P				

(continue)

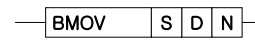
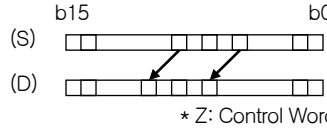
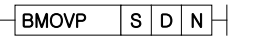
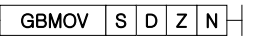
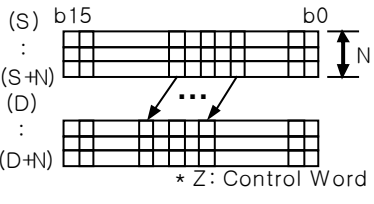
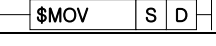
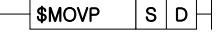
Classification	Designations	Symbol	Description	Support	
				XGK	XGK
Specified Bits Transfer	BMOV		 <p>(S) <span style="float: right;">b15</span>  <span style="float: right;">b0</span>            (D)            * Z: Control Word</p>	○	○
	BMOV P				
Specified Bits Group Transfer	GBMOV		 <p>(S) <span style="float: right;">b15</span>            :            (S+N) <span style="float: right;">b0</span>            (D)            :            (D+N)            * Z: Control Word</p>	○	○
String Transfer	\$MOV		String started from (S) → String started from (D)	○	○
	\$MOV P			○	○

### Appendix 3 Instruction List

(2) BCD/BIN conversion instruction

Classification	Designations	Symbol	Description	Support	
				XGK	XGB
BCD Conversion	BCD		(S) $\xrightarrow{\text{To BCD}}$ (D) $\uparrow$ BIN( 0~9999 )	O	O
	BCDP				
	DBCDCD		(S+1,S) $\xrightarrow{\text{To BCD}}$ (D+1,D ) $\uparrow$ BIN( 0~99999999 )	O	O
	DBCDCP				
4/8 Bits BCD Conversion	BCD4		(Sb):Bit, BIN(0~9) 	O	O
	BCD4P				
	BCD8		(Sb):Bit, BIN(0~99) 	O	O
	BCD8P				
BIN Conversion	BIN		(S) $\xrightarrow{\text{To BIN}}$ (D) $\uparrow$ BCD( 0~9999 )	O	O
	BINP				
	DBIN		(S+1,S) $\xrightarrow{\text{To BIN}}$ (D+1,D ) $\uparrow$ BCD( 0~99999999 )	O	O
	DBINP				
4/8 Bits BIN Conversion	BIN4		(Sb):Bit, BCD(0~9) 	O	O
	BIN4P				
	BIN8		(Sb):Bit, BCD(0~99) 	O	O
	BIN8P				
Group BCD,BIN Conversion	GBCD		<input type="checkbox"/> Data (S) to N converted to BCD, and (D) to N saved	O	O
	GBCDP				
	GBIN		<input type="checkbox"/> Data (S) to N converted to BIN, and (D) to N saved	O	O
	GBINP				



(3) Data type conversion instruction

Classification	Designations	Symbol	Description	Support	
				XGK	XGB
16 Bits Integer/Real Conversion	I2R		(S) $\xrightarrow{\text{To Real}}$ (D+1,D) $\uparrow$ Int(-32768~32767)	O	O
	I2RP				
	I2L		(S) $\xrightarrow{\text{To Long}}$ (D+3,D+2,D+1,D) $\uparrow$ Int(-32768~32767)	O	O
	I2LP				
32 Bits Integer/Real Conversion	D2R		(S+1,S) $\xrightarrow{\text{To Real}}$ (D+1,D) $\uparrow$ Dint(-2147483648~2147483647)	O	O
	D2RP				
	D2L		(S+1,S) $\xrightarrow{\text{To Long}}$ (D+3,D+2,D+1,D) $\uparrow$ Dint(-2147483648~2147483647)	O	O
	D2LP				
Short Real/Integer Conversion	R2I		(S+1,S) $\xrightarrow{\text{To INT}}$ (D) $\uparrow$ Whole Sino Real Range	O	O
	R2IP				
	R2D		(S+1,S) $\xrightarrow{\text{To DINT}}$ (D+1,D) $\uparrow$ Whole Sino Real Range	O	O
	R2DP				
Long Real/Integer Conversion	L2I		(S+3,S+2,S+1,S) $\xrightarrow{\text{To INT}}$ (D) $\uparrow$ Whole Double Real Range	O	O
	L2IP				
	L2D		(S+3,S+2,S+1,S) $\xrightarrow{\text{To DINT}}$ (D+1,D) $\uparrow$ Whole Double Real Range	O	O
	L2DP				

**Remark**

In case of XGB, Integer value and Real value will be saved respectively in quite different format. For such reason, Real Number Data should be converted as applicable before used for Integer Operation.

### Appendix 3 Instruction List

(4) Comparison instruction

Classification	Designations	Symbol	Description	Support	
				XGK	XGB
Unsigned Compare with Special Relay used	CMP		CMP(S1,S2) and applicable Flag Set (S1, S2 is Word)	○	○
	CMPP				
	DCMP		CMP(S1,S2) and applicable Flag Set (S1, S2 is Double Word)	○	○
	DCMPP				
4/8 Bits Compare	CMP4		CMP(S1,S2) and applicable Flag Set (S1, S2 is Nibble)	○	○
	CMP4P				
	CMP8		CMP(S1,S2) and applicable Flag Set (S1, S2 is Byte)	○	○
	CMP8P				
Table Compare	TCMP		CMP(S1,S2): CMP(S1+15,S2+15) Result:(D) ~ (D+15), 1 if identical	○	○
	TCMPP				
	DTCMP		CMP((S1+1,S1),(S2+1,S2)) CMP((S1+31,S1+30),(S2+31,S2+30)) Result:(D) ~ (D+15)	○	○
	DTCMPP				
Group Compare (16 Bits)	GEQ		Compares S1 data to S2 data word by word, and saves its result in Device (D) bit by bit from the lower bit (N ≤ 16)	○	○
	GEQP				
	GGT				
	GGTP				
	GLT				
	GLTP				
	GGE				
	GGEP				
	GLE				
	GLEP				
	GNE				
	GNEP				

**Remark**













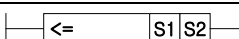

CMP(P), DCMP(P), CMP4(P), CMP8(P), TCMP(P) & DTCMP(P) Instructions all process the results of Unsigned Compare. All the other Compare Instructions will perform Signed Compare.

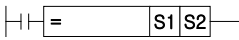
(continued)

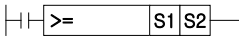
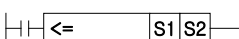
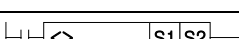
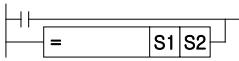
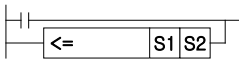
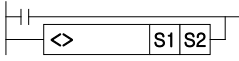
Classification	Designations	Symbol	Description	Support	
				XGK	XGB
Group Compare (32 Bits)	GDEQ	— <input type="checkbox"/> GDEQ <input type="checkbox"/> S1 <input type="checkbox"/> S2 <input type="checkbox"/> D <input type="checkbox"/> N <input type="checkbox"/> —	Compares S1 data to S2 data 2 by 2 words, and saves its result in Device (D) bit by bit from the lower bit (N ≤ 16)	<input type="radio"/>	<input type="radio"/>
	GDEQP	— <input type="checkbox"/> GDEQP <input type="checkbox"/> S1 <input type="checkbox"/> S2 <input type="checkbox"/> D <input type="checkbox"/> N <input type="checkbox"/> —		<input type="radio"/>	<input type="radio"/>
	GDGT	— <input type="checkbox"/> GDGT <input type="checkbox"/> S1 <input type="checkbox"/> S2 <input type="checkbox"/> D <input type="checkbox"/> N <input type="checkbox"/> —		<input type="radio"/>	<input type="radio"/>
	GDGTP	— <input type="checkbox"/> GDGTP <input type="checkbox"/> S1 <input type="checkbox"/> S2 <input type="checkbox"/> D <input type="checkbox"/> N <input type="checkbox"/> —		<input type="radio"/>	<input type="radio"/>
	GDLT	— <input type="checkbox"/> GDLT <input type="checkbox"/> S1 <input type="checkbox"/> S2 <input type="checkbox"/> D <input type="checkbox"/> N <input type="checkbox"/> —		<input type="radio"/>	<input type="radio"/>
	GDLTP	— <input type="checkbox"/> GDLTP <input type="checkbox"/> S1 <input type="checkbox"/> S2 <input type="checkbox"/> D <input type="checkbox"/> N <input type="checkbox"/> —		<input type="radio"/>	<input type="radio"/>
	GDGE	— <input type="checkbox"/> GDGE <input type="checkbox"/> S1 <input type="checkbox"/> S2 <input type="checkbox"/> D <input type="checkbox"/> N <input type="checkbox"/> —		<input type="radio"/>	<input type="radio"/>
	GDGEP	— <input type="checkbox"/> GDGEP <input type="checkbox"/> S1 <input type="checkbox"/> S2 <input type="checkbox"/> D <input type="checkbox"/> N <input type="checkbox"/> —		<input type="radio"/>	<input type="radio"/>
	GDLE	— <input type="checkbox"/> GDLE <input type="checkbox"/> S1 <input type="checkbox"/> S2 <input type="checkbox"/> D <input type="checkbox"/> N <input type="checkbox"/> —		<input type="radio"/>	<input type="radio"/>
	GDLEP	— <input type="checkbox"/> GDLEP <input type="checkbox"/> S1 <input type="checkbox"/> S2 <input type="checkbox"/> D <input type="checkbox"/> N <input type="checkbox"/> —		<input type="radio"/>	<input type="radio"/>
	GDNE	— <input type="checkbox"/> GDNE <input type="checkbox"/> S1 <input type="checkbox"/> S2 <input type="checkbox"/> D <input type="checkbox"/> N <input type="checkbox"/> —		<input type="radio"/>	<input type="radio"/>
	GDNEP	— <input type="checkbox"/> GDNEP <input type="checkbox"/> S1 <input type="checkbox"/> S2 <input type="checkbox"/> D <input type="checkbox"/> N <input type="checkbox"/> —		<input type="radio"/>	<input type="radio"/>

## Appendix 3 Instruction List

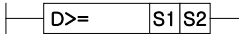
(continued)

Classification	Designations	Symbol	Description	Support	
				XGK	XGB
16 Bits Data Compare (LOAD)	LOAD=		Compares (S1) to (S2), and saves its result in Bit Result(BR) (Signed Operation)	○	○
	LOAD>				
	LOAD<				
	LOAD>=				
	LOAD<=				
	LOAD<>				
16 Bits Data Compare (AND)	AND=		Performs AND operation of (S1) & (S2) Compare Result and Bit Result (BR), and then saves its result in BR (Signed Operation)	○	○
	AND>				
	AND<				
	AND>=				
	AND<=				
	AND<>				
16 Bits Data Compare (OR)	OR=		Performs OR operation of (S1) & (S2) Compare Result and Bit Result (BR), and then saves its result in BR (Signed Operation)	○	○
	OR<=				
	OR<>				
32 Bits Data Compare (LOAD)	LOADD=		Compares (S1) to (S2), and saves its result in Bit Result(BR) (Signed Operation)	○	○
	LOADD>				
	LOADD<				
	LOADD>=				
	LOADD<=				
	LOADD<>				

(continued)

Classification	Designations	Symbol	Description	Support	
				XGK	XGB
32bit 데이터 비교 (AND)	ANDD=		Performs AND operation of (S1) & (S2) Compare Result and Bit Result (BR), and then saves its result in BR (Signed Operation)	O	O
	ANDD>				
	ANDD<				
	ANDD>=				
	ANDD<=				
	ANDD<>				
32bit Data Compare (OR)	ORD=		Performs OR operation of (S1) & (S2) Compare Result and Bit Result (BR), and then saves its result in BR (Signed Operation)	O	O
	ORD>				
	ORD<				
	ORD>=				
	ORD<=				
	ORD<>				
Short Real Number Compare (LOAD)	LOADR=		Performs OR operation of (S1) & (S2) Compare Result and Bit Result (BR), and then saves its result in BR (Signed Operation)	O	O
	LOADR>				
	LOADR<				
	LOADR>=				
	LOADR<=				
	LOADR<>				
Short Real Number Compare (AND)	ANDR=		Compares (S1+1,S) to (S2+1,S2) and saves its result in Bit Result (BR) (Signed Operation)	O	O
	ANDR>				
	ANDR<				
	ANDR>=				
	ANDR<=				
	ANDR<>				

Appendix 3 Instruction List

(continued)

Classification	Designations	Symbol	Description	Support	
				XGK	XGB
Short Real Number Compare (OR)	ORR=		Compares (S1+1,S1) to (S2+1,S2) and saves its result in Bit Result (BR) (Signed Operation)	O	O
	ORR>				
	ORR<				
	ORR>=				
	ORR<=				
	ORR<>				
Long Real Number Compare (LOAD)	LOADL=		Compares (S1+3,S1+2,S1+1,S) to (S2+3,S2+2, S2+1,S2) and saves its result in Bit Result(BR) (Signed Operation)	O	O
	LOADL>				
	LOADL<				
	LOADL>=				
	LOADL<=				
	LOADL<>				
Long Real Number Compare (AND)	ANDL=		Performs AND operation of (S1+1,S1) & (S2+1,S2) Compare Result and Bit Result(BR), and then saves its result in BR (Signed Operation)	O	O
	ANDL>				
	ANDL<				
	ANDL>=				
	ANDL<=				
	ANDL<>				

(continued)

Classification	Designations	Symbol	Description	Support	
				XGK	XGB
Double Real Number Compare (OR)	ORL=		Performs OR operation of (S1 +1,S1) & (S2+1,S2) Compare Result and Bit Result(BR), and then saves its result in BR (Signed Operation)	O	O
	ORL>				
	ORL<				
	ORL>=				
	ORL<=				
	ORL<>				
String Compare (LOAD)	LOAD\$=		Compares (S1) to (S2) Starting String and saves its result in Bit Result(BR)	O	O
	LOAD\$>				
	LOAD\$<				
	LOAD\$>=				
	LOAD\$<=				
	LOAD\$<>				
String Compare (AND)	AND\$=		Performs AND operation of (S1) & (S2) Starting String Compare Result and Bit Result(BR), and then saves its result in BR	O	O
	AND\$>				
	AND\$<				
	AND\$>=				
	AND\$<=				
	AND\$<>				

Appendix 3 Instruction List

(continued)

Classification	Designations	Symbol	Description	Support	
				XGK	XGB
String Compare (OR)	OR\$=		Performs OR operation of (S1) & (S2) Starting String Compare Result and Bit Result(BR), and then saves its result in BR	O	O
	OR\$>				
	OR\$<				
	OR\$>=				
	OR\$<=				
	OR\$<>				
16 Bits Data Group Compare (LOAD)	LOADG=		Compares (S1), (S1+1), ..., (S1+N) to (S2), (S2+1), ..., (S2+N) 1 to 1, and then saves 1 in Bit Result(BR) if each value compared meets given condition	O	O
	LOADG>				
	LOADG<				
	LOADG>=				
	LOADG<=				
	LOADG<>				
16 Bits Data Group Compare (AND)	ANDG=		Performs AND operation of (S1), (S1+1), ..., (S1+N) & (S2), (S2+1), ..., (S2+N) 1 to 1 Compare Result and Bit Result (BR), and then saves its result in BR	O	O
	ANDG>				
	ANDG<				
	ANDG>=				
	ANDG<=				
	ANDG<>				
16 Bits Data Group Compare (OR)	ORG=		Performs OR operation of (S1), (S1+1), ..., (S1+N) & (S2), (S2+1), ..., (S2+N) 1 to 1 Compare Result and Bit Result (BR), and then saves its result in BR	O	O
	ORG>				
	ORG<				
	ORG>=				
	ORG<=				
	ORG<>				





(continued)

Classification	Designations	Symbol	Description	Support	
				XGK	XGB
32 Bits Data Group Compare (LOAD)	LOADDG=		Compares (S1), (S1+1), ..., (S1+N) to (S2), (S2+1), ..., (S2+N) 1 to 1, and then saves 1 in Bit Result(BR) if each value compared meets given condition	0	0
	LOADDG>				
	LOADDG<				
	LOADDG>=				
	LOADDG<=				
	LOADDG<>				
32 Bits Data Group Compare (AND)	ANDDG=		Performs AND operation of (S1), (S1+1), ..., (S1+N) & (S2), (S2+1), ..., (S2+N) 1 to 1 Compare Result and Bit Result(BR), and then saves its result in BR	0	0
	ANDDG>				
	ANDDG<				
	ANDDG>=				
	ANDDG<=				
	ANDDG<>				
32 Bits Data Group Compare (OR)	ORDG=		Performs OR operation of (S1), (S1+1), ..., (S1+N) & (S2), (S2+1), ..., (S2+N) 1 to 1 Compare Result and Bit Result(BR), and then saves its result in BR	0	0
	ORDG>				
	ORDG<				
	ORDG>=				
	ORDG<=				
	ORDG<>				

## Appendix 3 Instruction List

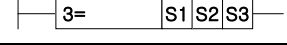
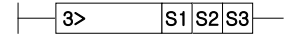
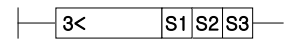
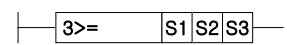
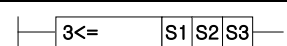
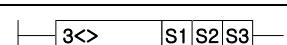
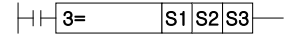
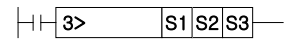
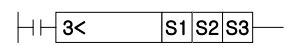
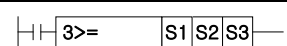
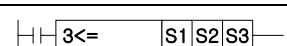
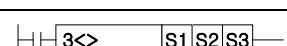
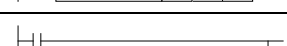
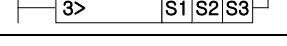
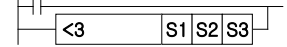
(continued)

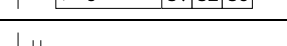
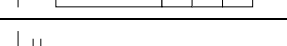
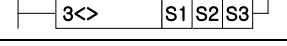
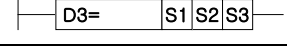
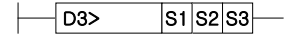
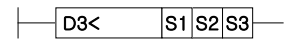
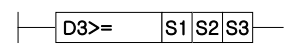
Classification	Designations	Symbol	Description	Support	
				XGK	XGB
Three 16-Bit Data Compare (LOAD)	LOAD3=		Saves 1 in Bit Result(BR) if each value of (S1), (S2), (S3) meets given condition	○	○
	LOAD3>				
	LOAD3<				
	LOAD3>=				
	LOAD3<=				
	LOAD3<>				
Three 16-Bit Data Compare (AND)	AND=		Performs AND operation of (S1), (S2), (S3) Compare Result by given condition and Bit Result (BR), and then saves its result in BR	○	○
	AND>				
	AND<				
	AND>=				
	AND<=				
	AND<>				
Three 32-Bit Data Compare (OR)	OR3=		Performs OR operation of (S1), (S2), (S3) Compare Result by given condition and Bit Result (BR), and then saves its result in BR	○	○
	OR3>				
	OR3<				
	OR3>=				
	OR3<=				
	OR3<>				
Three 16-Bit Data Compare (LOAD)	LOADD3=		Saves 1 in Bit Result(BR) if each value of (S1+1,S1), (S2+ 1,S2), (S3+1,S3) meets given condition	○	○
	LOADD3>				
	LOADD3<				
	LOADD3>=				
	LOADD3<=				
	LOADD3<>				

(continued)

Classification	Designations	Symbol	Description	Support	
				XGK	XGB
Three 32-Bit Data Compare (AND)	ANDD3=		Performs AND operation of (S1+1,S1), (S2+1,S2), (S3+1,S3) Compare Result by given condition and Bit Result(BR), and then saves its result in BR	O	O
	ANDD3>				
	ANDD3<				
	ANDD3>=				
	ANDD3<=				
	ANDD<>				
Three 32-Bit Data Compare (OR)	ORD3=		Performs OR operation of (S1+1, S1), (S2+1,S2), (S3+1,S3) Compare Result by given condition and Bit Result (BR), and then saves its result in BR	O	O
	ORD3>				
	ORD3<				
	ORD3>=				
	ORD3<=				
	ORD3<>				

### Appendix 3 Instruction List

(5) Increase/Decrease instruction

Classification	Designations	Symbol	Description	Support	
				XGK	XGB
BIN Data Increase / Decrease (Signed)	INC		$(D)+1 \longrightarrow (D)$	○	○
	INCP				
	DINC		$(D+1,D)+1 \longrightarrow (D+1,D)$		
	DINCP				
	DEC		$(D)-1 \longrightarrow (D)$	○	○
	DECP				
	DDEC		$(D+1,D)-1 \longrightarrow (D+1,D)$		
	DDECP				
4/8 Bits Data Increase / Decrease (Signed)	INC4		$(D:x \text{ bit} \sim D:x \text{ bit}+4) + 1$ $\longrightarrow (D:x \text{ bit} \sim D:x \text{ bit}+4)$	○	○
	INC4P				
	INC8		$(D:x \text{ bit} \sim D:x \text{ bit}+8) + 1$ $\longrightarrow (D:x \text{ bit} \sim D:x \text{ bit}+8)$		
	INC8P				
	DEC4		$(D:x \text{ bit} \sim D:x \text{ bit}+4) - 1$ $\longrightarrow (D:x \text{ bit} \sim D:x \text{ bit}+4)$	○	○
	DEC4P				
	DEC8		$(D:x \text{ bit} \sim D:x \text{ bit}+8) - 1$ $\longrightarrow (D:x \text{ bit} \sim D:x \text{ bit}+8)$		
	DEC8P				
BIN Data Increase / Decrease (Unsigned)	INCUP		$(D)+1 \longrightarrow (D)$	○	○
	INCUCU				
	DINCUP		$(D+1,D)+1 \longrightarrow (D+1,D)$		
	DINCUCU				
	DECUP		$(D)-1 \longrightarrow (D)$	○	○
	DECUCU				
	DDECUP		$(D+1,D)-1 \longrightarrow (D+1,D)$		
	DDECUCU				

(6) Rotation instruction

Classification	Designations	Symbol	Description	Support	
				XGK	XGB
Rotate to Left	ROL			O	O
	ROLP				
	DROL				
	DROLP				
4/8 Bits Rotate to Left	ROL4			O	O
	ROL4P				
	ROL8				
	ROL8P				
Rotate to Right	ROR			O	O
	RORP				
	DROR				
	DRORP				
4/8 Bits Rotate to Right	ROR4			O	O
	ROR4P				
	ROR8				
	ROR8P				
Rotate to Left (including Carry)	RCL			O	O
	RCLP				
	DRCL				
	DRCLP				
4/8 Bits Rotate to Left (including Carry)	RCL4			O	O
	RCL4P				
	RCL8				
	RCL8P				
Rotate to Right (including Carry)	RCR			O	O
	RCRP				
	DRCR				
	DRCRP				
4/8 Bits Rotate to Right (including Carry)	RCR4			O	O
	RCR4P				
	RCR8				
	RCR8P				

Appendix 3 Instruction List

(7) Move location

Classification	Designations	Symbol	Description	Support	
				XGK	XGB
Bits Move	BSFT			○	○
	BSFTP				
Move to Higher Bit	BSFL			○	○
	BSFLP				
	DBSFL				
	DBSFLP				
Move to Higher Bit within 4/8 Bits range	BSFL4			○	○
	BSFL4P				
	BSFL8				
	BSFL8P				
Move to Lower Bit	BSFR			○	○
	BSFRP				
	DBSFR				
	DBSFRP				
Move to Lower Bit within 4/8 Bits range	BSFR4			○	○
	BSFR4P				
	BSFR8				
	BSFR8P				
Word Move	WSFT			○	○
	WSFTP				
Word Data Move to Left/Right	WSFL			○	○
	WSFLP				
	WSFR				
	WSFRP				
Bit Move	SR		Moves N bits starting from Db bit along Input direction (I) and Move direction (D)	○	○

(8) Exchange instruction

Classification	Designations	Symbol	Description	Support	
				XGK	XGB
Data Exchange	XCHG		(D1) ↔ (D2)	O	O
	XCHGP				
	DXCHG		(D1+1, D1) ↔ (D2+1, D2)		
	DXCHGP				
Group Data Exchange	GXCHG			O	O
	GXCHGP				
Higher/Lower Byte Exchange	SWAP			O	O
	SWAPP				
Group Byte Exchange	GSWAP		D부터 N개의 워드를 상하위 바이트 교환	O	O
	GSWAPP				

## Appendix 3 Instruction List

### (9) BIN operation instruction

Classification	Designations	Symbol	Description	Support	
				XGK	XGB
Integer Addition (Signed)	ADD	$\text{---} \boxed{\text{ADD}} \boxed{\text{S1}} \boxed{\text{S2}} \boxed{\text{D}} \text{---}$	$(S1)+(S2) \longrightarrow (D)$	O	O
	ADDP	$\text{---} \boxed{\text{ADDP}} \boxed{\text{S1}} \boxed{\text{S2}} \boxed{\text{D}} \text{---}$			
	DADD	$\text{---} \boxed{\text{DADD}} \boxed{\text{S1}} \boxed{\text{S2}} \boxed{\text{D}} \text{---}$	$(S1+1,S1)+(S2+1,S2)$		
	DADDP	$\text{---} \boxed{\text{DADDP}} \boxed{\text{S1}} \boxed{\text{S2}} \boxed{\text{D}} \text{---}$	$\longrightarrow (D+1,D)$		
Integer Subtraction (Signed)	SUB	$\text{---} \boxed{\text{SUB}} \boxed{\text{S1}} \boxed{\text{S2}} \boxed{\text{D}} \text{---}$	$(S1)-(S2) \longrightarrow (D)$	O	O
	SUBP	$\text{---} \boxed{\text{SUBP}} \boxed{\text{S1}} \boxed{\text{S2}} \boxed{\text{D}} \text{---}$			
	DSUB	$\text{---} \boxed{\text{DSUB}} \boxed{\text{S1}} \boxed{\text{S2}} \boxed{\text{D}} \text{---}$	$(S1+1,S1)-(S2+1,S2)$		
	DSUBP	$\text{---} \boxed{\text{DSUBP}} \boxed{\text{S1}} \boxed{\text{S2}} \boxed{\text{D}} \text{---}$	$\longrightarrow (D+1,D)$		
Integer Multiplication (Signed)	MUL	$\text{---} \boxed{\text{MUL}} \boxed{\text{S1}} \boxed{\text{S2}} \boxed{\text{D}} \text{---}$	$(S1) \times (S2) \longrightarrow (D+1,D)$	O	O
	MULP	$\text{---} \boxed{\text{MULP}} \boxed{\text{S1}} \boxed{\text{S2}} \boxed{\text{D}} \text{---}$			
	DMUL	$\text{---} \boxed{\text{DMUL}} \boxed{\text{S1}} \boxed{\text{S2}} \boxed{\text{D}} \text{---}$	$(S1+1,S1) \times (S2+1,S2)$		
	DMULP	$\text{---} \boxed{\text{DMULP}} \boxed{\text{S1}} \boxed{\text{S2}} \boxed{\text{D}} \text{---}$	$\longrightarrow (D+3,D+2,D+1,D)$		
Integer Division (Signed)	DIV	$\text{---} \boxed{\text{DIV}} \boxed{\text{S1}} \boxed{\text{S2}} \boxed{\text{D}} \text{---}$	$(S1) \div (S2) \longrightarrow \begin{matrix} (D) \text{ Quotient} \\ (D+1) \text{ Remainder} \end{matrix}$	O	O
	DIVP	$\text{---} \boxed{\text{DIVP}} \boxed{\text{S1}} \boxed{\text{S2}} \boxed{\text{D}} \text{---}$			
	DDIV	$\text{---} \boxed{\text{DDIV}} \boxed{\text{S1}} \boxed{\text{S2}} \boxed{\text{D}} \text{---}$	$(S1+1,S1) \div (S2+1,S2)$		
	DDIVP	$\text{---} \boxed{\text{DDIVP}} \boxed{\text{S1}} \boxed{\text{S2}} \boxed{\text{D}} \text{---}$	$\longrightarrow \begin{matrix} (D+1,D) \text{ Quotient} \\ (D+3,D+2) \text{ Remainder} \end{matrix}$		
Integer Addition (Unsigned)	ADDU	$\text{---} \boxed{\text{ADDU}} \boxed{\text{S1}} \boxed{\text{S2}} \boxed{\text{D}} \text{---}$	$(S1)+(S2) \longrightarrow (D)$	O	O
	ADDUP	$\text{---} \boxed{\text{ADDUP}} \boxed{\text{S1}} \boxed{\text{S2}} \boxed{\text{D}} \text{---}$			
	DADDU	$\text{---} \boxed{\text{DADDU}} \boxed{\text{S1}} \boxed{\text{S2}} \boxed{\text{D}} \text{---}$	$(S1+1,S1)+(S2+1,S2)$		
	DADDUP	$\text{---} \boxed{\text{DADDUP}} \boxed{\text{S1}} \boxed{\text{S2}} \boxed{\text{D}} \text{---}$	$\longrightarrow (D+1,D)$		
Integer Subtraction (Unsigned)	SUBU	$\text{---} \boxed{\text{SUBU}} \boxed{\text{S1}} \boxed{\text{S2}} \boxed{\text{D}} \text{---}$	$(S1)-(S2) \longrightarrow (D)$	O	O
	SUBUP	$\text{---} \boxed{\text{SUBUP}} \boxed{\text{S1}} \boxed{\text{S2}} \boxed{\text{D}} \text{---}$			
	DSUBU	$\text{---} \boxed{\text{DSUBU}} \boxed{\text{S1}} \boxed{\text{S2}} \boxed{\text{D}} \text{---}$	$(S1+1,S1)-(S2+1,S2)$		
	DSUBUP	$\text{---} \boxed{\text{DSUBUP}} \boxed{\text{S1}} \boxed{\text{S2}} \boxed{\text{D}} \text{---}$	$\longrightarrow (D+1,D)$		
Integer Multiplication (Unsigned)	MULU	$\text{---} \boxed{\text{MULU}} \boxed{\text{S1}} \boxed{\text{S2}} \boxed{\text{D}} \text{---}$	$(S1) \times (S2) \longrightarrow (D+1,D)$	O	O
	MULUP	$\text{---} \boxed{\text{MULUP}} \boxed{\text{S1}} \boxed{\text{S2}} \boxed{\text{D}} \text{---}$			
	DMULU	$\text{---} \boxed{\text{DMULU}} \boxed{\text{S1}} \boxed{\text{S2}} \boxed{\text{D}} \text{---}$	$(S1+1,S1) \times (S2+1,S2)$		
	DMULUP	$\text{---} \boxed{\text{DMULUP}} \boxed{\text{S1}} \boxed{\text{S2}} \boxed{\text{D}} \text{---}$	$\longrightarrow (D+3,D+2,D+1,D)$		



Appendix 3 Instruction List

(continued)

Classification	Designations	Symbol	Description	Support	
				XGK	XGB
Integer Division (Unsigned)	DIVU		$(S1) \div (S2) \longrightarrow (D) \text{ 몫}$ $(D+1) \text{ 나머지}$	O	O
	DIVUP				
	DDIVU		$(S1+1, S1) \div (S2+1, S2)$		
	DDIVUP		$\longrightarrow (D+1, D) \text{ 몫}$ $(D+3, D+2) \text{ 나머지}$		
Real Number Addition	RADD		$(S1+1, S1) + (S2+1, S2)$ $\longrightarrow (D+1, D)$	O	O
	RADDP				
	LADD		$(S1+3, S1+2, S1+1, S1)$ $+ (S2+3, S2+2, S2+1, S2)$		
	LADDP		$\longrightarrow (D+3, D+2, D+1, D)$		
Real Number Subtraction	RSUB		$(S1+1, S1) - (S2+1, S2)$ $\longrightarrow (D+1, D)$	O	O
	RSUBP				
	LSUB		$(S1+3, S1+2, S1+1, S1)$ $- (S2+3, S2+2, S2+1, S2)$		
	LSUBP		$\longrightarrow (D+3, D+2, D+1, D)$		
Real Number Multiplication	RMUL		$(S1+1, S1) \times (S2+1, S2)$ $\longrightarrow (D+1, D)$	O	O
	RMULP				
	LMUL		$(S1+3, S1+2, S1+1, S1)$ $\times (S2+3, S2+2, S2+1, S2)$		
	LMULP		$\longrightarrow (D+3, D+2, D+1, D)$		
Real Number Division	RDIV		$(S1+1, S1) \div (S2+1, S2)$ $\longrightarrow (D+1, D)$	O	O
	RDIVP				
	LDIV		$(S1+3, S1+2, S1+1, S1)$ $\div (S2+3, S2+2, S2+1, S2)$		
	LDIVP		$\longrightarrow (D+3, D+2, D+1, D)$		
String Addition	\$ADD		Connects S1 String with S2 String to save in D	O	O
	\$ADDP				
Group Addition	GADD			O	O
	GADDP				
Group Subtraction	GSUB			O	O
	GSUBP				

## Appendix 3 Instruction List

### (10) BCD operation instruction

Classification	Designations	Symbol	Description	Support	
				XGK	XGB
BCD Addition	ADDB	$\text{---} \boxed{\text{ADDB}} \boxed{\text{S1}} \boxed{\text{S2}} \boxed{\text{D}} \text{---}$	$(S1)+(S2) \longrightarrow (D)$	O	O
	ADDBP	$\text{---} \boxed{\text{ADDBP}} \boxed{\text{S1}} \boxed{\text{S2}} \boxed{\text{D}} \text{---}$			
	DADDB	$\text{---} \boxed{\text{DADDB}} \boxed{\text{S1}} \boxed{\text{S2}} \boxed{\text{D}} \text{---}$	$(S1+1,S1)+(S2+1,S2) \longrightarrow (D+1,D)$		
	DADDBP	$\text{---} \boxed{\text{DADDBP}} \boxed{\text{S1}} \boxed{\text{S2}} \boxed{\text{D}} \text{---}$			
BCD Subtraction	SUBB	$\text{---} \boxed{\text{SUBB}} \boxed{\text{S1}} \boxed{\text{S2}} \boxed{\text{D}} \text{---}$	$(S1)-(S2) \longrightarrow (D)$	O	O
	SUBBP	$\text{---} \boxed{\text{SUBBP}} \boxed{\text{S1}} \boxed{\text{S2}} \boxed{\text{D}} \text{---}$			
	DSUBB	$\text{---} \boxed{\text{DSUBB}} \boxed{\text{S1}} \boxed{\text{S2}} \boxed{\text{D}} \text{---}$	$(S1+1,S1)-(S2+1,S2) \longrightarrow (D+1,D)$		
	DSUBBP	$\text{---} \boxed{\text{DSUBBP}} \boxed{\text{S1}} \boxed{\text{S2}} \boxed{\text{D}} \text{---}$			
BCD Multiplication	MULB	$\text{---} \boxed{\text{MULB}} \boxed{\text{S1}} \boxed{\text{S2}} \boxed{\text{D}} \text{---}$	$(S1) \times (S2) \longrightarrow (D+1,D)$	O	O
	MULBP	$\text{---} \boxed{\text{MULBP}} \boxed{\text{S1}} \boxed{\text{S2}} \boxed{\text{D}} \text{---}$			
	DMULB	$\text{---} \boxed{\text{DMULB}} \boxed{\text{S1}} \boxed{\text{S2}} \boxed{\text{D}} \text{---}$	$(S1+1,S1) \times (S2+1,S2) \longrightarrow (D+3,D+2,D+1,D)$		
	DMULBP	$\text{---} \boxed{\text{DMULBP}} \boxed{\text{S1}} \boxed{\text{S2}} \boxed{\text{D}} \text{---}$			
BCD Division	DIVB	$\text{---} \boxed{\text{DIVB}} \boxed{\text{S1}} \boxed{\text{S2}} \boxed{\text{D}} \text{---}$	$(S1) \div (S2) \longrightarrow \begin{matrix} (D) \text{ Quotient} \\ (D+1) \text{ Remainder} \end{matrix}$	O	O
	DIVBP	$\text{---} \boxed{\text{DIVBP}} \boxed{\text{S1}} \boxed{\text{S2}} \boxed{\text{D}} \text{---}$			
	DDIVB	$\text{---} \boxed{\text{DDIVB}} \boxed{\text{S1}} \boxed{\text{S2}} \boxed{\text{D}} \text{---}$	$(S1+1,S1) \div (S2+1,S2) \longrightarrow \begin{matrix} (D+1,D) \text{ Quotient} \\ (D+3,D+2) \text{ Remainder} \end{matrix}$		
	DDIVBP	$\text{---} \boxed{\text{DDIVBP}} \boxed{\text{S1}} \boxed{\text{S2}} \boxed{\text{D}} \text{---}$			

(11) Logic operation instruction

Classification	Designations	Symbol	Description	Support	
				XGK	XGB
Logic Multiplication	WAND		Word AND $(S1) \wedge (S2) \longrightarrow (D)$	○	○
	WANDP				
	DWAND		DWord AND $(S1+1, S1) \wedge (S2+1, S2) \longrightarrow (D+1, D)$		
	DWANDP				
Logic Addition	WOR		Word OR $(S1) \vee (S2) \longrightarrow (D)$	○	○
	WORP				
	DWOR		DWord OR $(S1+1, S1) \vee (S2+1, S2) \longrightarrow (D+1, D)$		
	DWORP				
Exclusive OR	WXOR		Word Exclusive OR $(S1) \veebar (S2) \longrightarrow (D)$	○	○
	WXORP				
	DWXOR		DWord Exclusive OR $(S1+1, S1) \veebar (S2+1, S2) \longrightarrow (D+1, D)$		
	DWXORP				
Exclusive NOR	WXNR		Word Exclusive NOR $(S1) \veebar (S2) \longrightarrow (D)$	○	○
	WXNRP				
	DWXNR		DWord Exclusive NOR $(S1+1, S1) \veebar (S2+1, S2) \longrightarrow (D+1, D)$		
	DWXNRP				
Group Logic Operation	GWAND			○	○
	GWANDP				
	GWOR				
	GWORP				
	GWXOR				
	GWXORP				
	GWXNR				
	GWXNRP				

Appendix 3 Instruction List

(12) Data process instruction (continued)

Classification	Designations	Symbol	Description	Support	
				XGK	XGB
Bit Check	BSUM			O	O
	BSUMP				
	DBSUM				
	DBSUMP				
Bit Reset	BRST		Resets N Bits (starting from D) to 0	O	O
	BRSTP				
Encode	ENCO			O	O
	ENCOP				
Decode	DECO			O	O
	DECOP				
Data Disconnect & Connect	DIS			O	O
	DISP				
	UNI				
	UNIP				
Word/Byte Conversion	WTOB			O	O
	WTOBP				
	BTOW				
	BTOWP				
I/O Refresh	IORF		Right after masking I/O data (located on S1) with S2 and S3 data, perform process	O	O
	IORFP				
Data Search	SCH		Finds S1 value within S2 ~ N range and saves the first identical valued position in D and S1's identical valued total number in D+1	O	O
	SCHP				
	DSCH				
	DSCHP				
Max. Value Search	MAX		Saves the max value in D among N words starting from S	O	O
	MAXP				
	DMAX		Saves the max value in D among N double words starting from S		
	DMAXP				

Classification	Designations	Symbol	Description	Support	
				XGK	XGB
Min. Value Search	MIN	$\boxed{\text{MIN}} \quad \boxed{S} \quad \boxed{D} \quad \boxed{n}$	Saves the min value in D among N words starting from S	O	O
	MINP	$\boxed{\text{MINP}} \quad \boxed{S} \quad \boxed{D} \quad \boxed{n}$			
	DMIN	$\boxed{\text{DMIN}} \quad \boxed{S} \quad \boxed{D} \quad \boxed{n}$	Saves the min value in D among N double words starting from S		
	DMINP	$\boxed{\text{DMINP}} \quad \boxed{S} \quad \boxed{D} \quad \boxed{n}$			
Sum	SUM	$\boxed{\text{SUM}} \quad \boxed{S} \quad \boxed{D} \quad \boxed{n}$	Adds up N words starting from S to save in D	O	O
	SUMP	$\boxed{\text{SUMP}} \quad \boxed{S} \quad \boxed{D} \quad \boxed{n}$			
	DSUM	$\boxed{\text{DSUM}} \quad \boxed{S} \quad \boxed{D} \quad \boxed{n}$	Adds up N double words starting from S to save in D		
	DSUMP	$\boxed{\text{DSUMP}} \quad \boxed{S} \quad \boxed{D} \quad \boxed{n}$			
Average	AVE	$\boxed{\text{AVE}} \quad \boxed{S} \quad \boxed{D} \quad \boxed{n}$	Averages N words starting from S to save in D	O	O
	AVEP	$\boxed{\text{AVEP}} \quad \boxed{S} \quad \boxed{D} \quad \boxed{n}$			
	DAVE	$\boxed{\text{DAVE}} \quad \boxed{S} \quad \boxed{D} \quad \boxed{n}$	Averages N double words starting from S to save in D		
	DAVEP	$\boxed{\text{DAVEP}} \quad \boxed{S} \quad \boxed{D} \quad \boxed{n}$			
MUX	MUX	$\boxed{\text{MUX}} \quad \boxed{S1} \quad \boxed{S2} \quad \boxed{D} \quad \boxed{N}$		O	O
	MUXP	$\boxed{\text{MUXP}} \quad \boxed{S1} \quad \boxed{S2} \quad \boxed{D} \quad \boxed{N}$			
	DMUX	$\boxed{\text{DMUX}} \quad \boxed{S1} \quad \boxed{S2} \quad \boxed{D} \quad \boxed{N}$			
	DMUXP	$\boxed{\text{DMUXP}} \quad \boxed{S1} \quad \boxed{S2} \quad \boxed{D} \quad \boxed{N}$			
Data Detect	DETECT	$\boxed{\text{DETECT}} \quad \boxed{S1} \quad \boxed{S2} \quad \boxed{D} \quad \boxed{N}$	Detects N data from S1, to save the first value larger than S2 in D, and the extra number in D+1	O	O
	DETECTP	$\boxed{\text{DETECTP}} \quad \boxed{S1} \quad \boxed{S2} \quad \boxed{D} \quad \boxed{N}$			
Ramp Signal Output	RAMP	$\boxed{\text{RAMP}} \quad \boxed{n1} \quad \boxed{n2} \quad \boxed{D1} \quad \boxed{n3} \quad \boxed{D2}$	Saves linear-changed value in D1 during n3 scanning of initial value n1 to final n2 and present scanning number in D1+1, and changes D2 value to ON after completed	O	O
Data Align	SORT	$\boxed{\text{SORT}} \quad \boxed{S} \quad \boxed{n1} \quad \boxed{n2} \quad \boxed{D1} \quad \boxed{D2}$	S : Head Address of Sort Data n1 : Number of Words to sort n1+1 : Sorting Method n2 : Operation number per Scan D1 : ON if complete D2 : Auxiliary Area	O	O
	SORTP	$\boxed{\text{SORTP}} \quad \boxed{S} \quad \boxed{n1} \quad \boxed{n2} \quad \boxed{D1} \quad \boxed{D2}$			
Time-based ramp signal output	TRAMP	$\boxed{\text{TRAMP}} \quad \boxed{N1} \quad \boxed{N2} \quad \boxed{N3} \quad \boxed{D}$	During time N3 (s), saves data changing linealy from initial value to last value in D, saves timer value in D+2, if completed, D become equal to N2	O	O
	RTRAMP	$\boxed{\text{RTRAMP}} \quad \boxed{N1} \quad \boxed{N2} \quad \boxed{N3} \quad \boxed{D}$			

### Appendix 3 Instruction List

(13) Data process instruction (continued)

Classification	Designations	Symbol	Description	Support	
				XGK	XGB
Data Write	FWR	$\text{---} \boxed{\text{FWR}} \text{---} \boxed{\text{S}} \boxed{\text{D}} \text{---}$	Adds S to the last of Data Table D ~ D+N, and increases Data Table Length(N) saved in D by 1	○	○
	FWRP	$\text{---} \boxed{\text{FWRP}} \text{---} \boxed{\text{S}} \boxed{\text{D}} \text{---}$			
First-input Data Read	FIFRD	$\text{---} \boxed{\text{FIFRD}} \text{---} \boxed{\text{S}} \boxed{\text{D}} \text{---}$	Moves first data, S+1 of Data Table S ~ S+N to D (pull 1 place after origin deleted) and decreases Data Table Length(N) saved in D by 1 S	○	○
	FIFRDP	$\text{---} \boxed{\text{FIFRDP}} \text{---} \boxed{\text{S}} \boxed{\text{D}} \text{---}$			
Last-Input Data Read	FILRD	$\text{---} \boxed{\text{FILRD}} \text{---} \boxed{\text{S}} \boxed{\text{D}} \text{---}$	Moves last data, S+N of Data Table S ~ S+N to D (origin deleted) and decreases Data Table Length(N) saved in D by 1 S	○	○
	FILRDP	$\text{---} \boxed{\text{FILRDP}} \text{---} \boxed{\text{S}} \boxed{\text{D}} \text{---}$			
Data Insert	FIINS	$\text{---} \boxed{\text{FINS}} \text{---} \boxed{\text{S}} \boxed{\text{D}} \boxed{\text{n}} \text{---}$	Adds S to 'N'th place of Data Table D ~ D+N (origin data pulled by 1), and increases Data Table Length(N) saved in D by 1	○	○
	FIINSP	$\text{---} \boxed{\text{FINSP}} \text{---} \boxed{\text{S}} \boxed{\text{D}} \boxed{\text{n}} \text{---}$			
Data Pull	FIDEL	$\text{---} \boxed{\text{FDEL}} \text{---} \boxed{\text{S}} \boxed{\text{D}} \boxed{\text{n}} \text{---}$	Deletes 'N'th data of Data Table S ~ S+N (pull 1 place) and decreases Data Table Length(N) saved in D by 1	○	○
	FIDELP	$\text{---} \boxed{\text{FDELP}} \text{---} \boxed{\text{S}} \boxed{\text{D}} \boxed{\text{n}} \text{---}$			

(14) Display instruction

Classification	Designations	Symbol	Description	Support	
				XGK	XGB
7 Segment Display	SEG	$\text{---} \boxed{\text{SEG}} \text{---} \boxed{\text{S}} \boxed{\text{D}} \boxed{\text{Z}} \text{---}$	Converts S Data to 7-Segment as adjusted in Z Format so to save in D	○	○
	SEGP	$\text{---} \boxed{\text{SEGP}} \text{---} \boxed{\text{S}} \boxed{\text{D}} \boxed{\text{Z}} \text{---}$			

(15) 문자열 처리 명령

Classification	Designations	Symbol	Description	Support	
				XGK	XGB
Convert to Decimal ASCII Cord	BINDA	— <span style="border: 1px solid black; padding: 2px;">BINDA</span> <span style="border: 1px solid black; padding: 2px;">S</span> <span style="border: 1px solid black; padding: 2px;">D</span> —	Converts S of 1-word BIN value to Decimal ASCII Cord to save in starting D	○	○
	BINDAP	— <span style="border: 1px solid black; padding: 2px;">BINDAP</span> <span style="border: 1px solid black; padding: 2px;">S</span> <span style="border: 1px solid black; padding: 2px;">D</span> —			
	DBINDA	— <span style="border: 1px solid black; padding: 2px;">DBINDA</span> <span style="border: 1px solid black; padding: 2px;">S</span> <span style="border: 1px solid black; padding: 2px;">D</span> —	Converts S of 2-word BIN value to Decimal ASCII Cord to save in starting D		
	DBINDAP	— <span style="border: 1px solid black; padding: 2px;">DBINDAP</span> <span style="border: 1px solid black; padding: 2px;">S</span> <span style="border: 1px solid black; padding: 2px;">D</span> —			
Convert to Hexadecimal ASCII Cord	BINHA	— <span style="border: 1px solid black; padding: 2px;">BINHA</span> <span style="border: 1px solid black; padding: 2px;">S</span> <span style="border: 1px solid black; padding: 2px;">D</span> —	Converts S of 1-word BIN value to Hexadecimal ASCII Cord to save in starting D	○	○
	BINHAP	— <span style="border: 1px solid black; padding: 2px;">BINHAP</span> <span style="border: 1px solid black; padding: 2px;">S</span> <span style="border: 1px solid black; padding: 2px;">D</span> —			
	DBINHA	— <span style="border: 1px solid black; padding: 2px;">DBINHA</span> <span style="border: 1px solid black; padding: 2px;">S</span> <span style="border: 1px solid black; padding: 2px;">D</span> —	Converts S of 2-word BIN value to Hexadecimal ASCII Cord to save in starting D		
	DBINHAP	— <span style="border: 1px solid black; padding: 2px;">DBINHAP</span> <span style="border: 1px solid black; padding: 2px;">S</span> <span style="border: 1px solid black; padding: 2px;">D</span> —			
Convert BCD to Decimal ASCII Cord	BCDDA	— <span style="border: 1px solid black; padding: 2px;">BCDDA</span> <span style="border: 1px solid black; padding: 2px;">S</span> <span style="border: 1px solid black; padding: 2px;">D</span> —	Converts S of 1-word BCD to ASCII Cord to save in starting D	○	○
	BCDDAP	— <span style="border: 1px solid black; padding: 2px;">BCDDAP</span> <span style="border: 1px solid black; padding: 2px;">S</span> <span style="border: 1px solid black; padding: 2px;">D</span> —			
	DBCDDA	— <span style="border: 1px solid black; padding: 2px;">DBCDDA</span> <span style="border: 1px solid black; padding: 2px;">S</span> <span style="border: 1px solid black; padding: 2px;">D</span> —	Converts S of 2-word BCD to ASCII Cord to save in starting D		
	DBCDDAP	— <span style="border: 1px solid black; padding: 2px;">DBCDDAP</span> <span style="border: 1px solid black; padding: 2px;">S</span> <span style="border: 1px solid black; padding: 2px;">D</span> —			
Convert Decimal ASCII to BIN	DABIN	— <span style="border: 1px solid black; padding: 2px;">DABIN</span> <span style="border: 1px solid black; padding: 2px;">S</span> <span style="border: 1px solid black; padding: 2px;">D</span> —	Converts S S+2,S+1,S's Decimal ASCII Cord to BIN to save in D	○	○
	DABINP	— <span style="border: 1px solid black; padding: 2px;">DABINP</span> <span style="border: 1px solid black; padding: 2px;">S</span> <span style="border: 1px solid black; padding: 2px;">D</span> —			
	DDABIN	— <span style="border: 1px solid black; padding: 2px;">DDABIN</span> <span style="border: 1px solid black; padding: 2px;">S</span> <span style="border: 1px solid black; padding: 2px;">D</span> —	Converts S+5~S's Decimal ASCII Cord to BIN value to save in D+1 & D		
	DDABINP	— <span style="border: 1px solid black; padding: 2px;">DDABINP</span> <span style="border: 1px solid black; padding: 2px;">S</span> <span style="border: 1px solid black; padding: 2px;">D</span> —			
Convert Hexadecimal ASCII to BIN	HABIN	— <span style="border: 1px solid black; padding: 2px;">HABIN</span> <span style="border: 1px solid black; padding: 2px;">S</span> <span style="border: 1px solid black; padding: 2px;">D</span> —	Converts S+1,S's Hexadecimal ASCII Cord to BIN value to save in D	○	○
	HABINP	— <span style="border: 1px solid black; padding: 2px;">HABINP</span> <span style="border: 1px solid black; padding: 2px;">S</span> <span style="border: 1px solid black; padding: 2px;">D</span> —			
	DHABIN	— <span style="border: 1px solid black; padding: 2px;">DHABIN</span> <span style="border: 1px solid black; padding: 2px;">S</span> <span style="border: 1px solid black; padding: 2px;">D</span> —	Converts S+3~S's Hexadecimal ASCII Cord to BIN to save in D		
	DHABINP	— <span style="border: 1px solid black; padding: 2px;">DHABINP</span> <span style="border: 1px solid black; padding: 2px;">S</span> <span style="border: 1px solid black; padding: 2px;">D</span> —			
Convert Decimal ASCII to BCD	DABCD	— <span style="border: 1px solid black; padding: 2px;">DABCD</span> <span style="border: 1px solid black; padding: 2px;">S</span> <span style="border: 1px solid black; padding: 2px;">D</span> —	Converts S+1,S's Decimal ASCII Cord to BCD to save in D	○	○
	DABCDP	— <span style="border: 1px solid black; padding: 2px;">DABCDP</span> <span style="border: 1px solid black; padding: 2px;">S</span> <span style="border: 1px solid black; padding: 2px;">D</span> —			
	DDABCD	— <span style="border: 1px solid black; padding: 2px;">DDABCD</span> <span style="border: 1px solid black; padding: 2px;">S</span> <span style="border: 1px solid black; padding: 2px;">D</span> —	Converts S+3~S's Decimal ASCII Cord to BCD to save in D		
	DDABCDP	— <span style="border: 1px solid black; padding: 2px;">DDABCDP</span> <span style="border: 1px solid black; padding: 2px;">S</span> <span style="border: 1px solid black; padding: 2px;">D</span> —			
String Length Detect	LEN	— <span style="border: 1px solid black; padding: 2px;">LEN</span> <span style="border: 1px solid black; padding: 2px;">S</span> <span style="border: 1px solid black; padding: 2px;">D</span> —	Saves String Length with S starting in D	○	○
	LENP	— <span style="border: 1px solid black; padding: 2px;">LENP</span> <span style="border: 1px solid black; padding: 2px;">S</span> <span style="border: 1px solid black; padding: 2px;">D</span> —			

**Appendix 3 Instruction List**

(continued)

Classification	Designations	Symbol	Description	Support	
				XGK	XGB
Convert BIN16/32 to String	STR	—STR S1 S2 D—	Adjusts S2 saved word data to S1 saved place number to convert to String and save in D	O	O
	STRP	—STRP S1 S2 D—			
	DSTR	—DSTR S1 S2 D—	Adjusts S2 saved double word data to S1 saved place number to convert to String and save in D		
	DSTRP	—DSTRP S1 S2 D—			
Convert String to BIN16/32	VAL	—VAL S D1 D2—	Adjusts S saved string to number to save in word D1 and saves the place number in D2	O	O
	VALP	—VALP S D1 D2—			
	DVAL	—DVAL S D1 D2—	Adjusts S saved string to number to save in double word D1 and saves the place number in D2		
	DVALP	—DVALP S D1 D2—			
Convert Real Number to String	RSTR	—RSTR S1 S2 D—	Adjusts Floating decimal point point Real Number Data (S1: number, S2: places) to String format to save in D	O	X
	RSTRP	—RSTRP S1 S2 D—			
	LSTR	—LSTR S1 S2 D—	Adjusts Floating decimal point point Double Real Number Data (S1:number, S2:places) to String format to save in D		
	LSTRP	—LSTRP S1 S2 D—			
Convert String to Real Number	STRR	—STRR S D—	Converts String S to Floating decimal point point Real Number Data to save in D	O	X
	STRRP	—STRRP S D—			
	STRL	—STRL S D—	Converts String S to Floating decimal point point Double Real Number Data to save in D		
	STRLP	—STRLP S D—			
ASCII Conversion	ASC	—ASC S D cw—	Converts BIN Data to ASCII in Nibble unit, based on cw's format from S to save in D	O	O
	ASCP	—ASCP S D cw—			
HEX Conversion	HEX	—HEX S D N—	Converts 2N ASCII saved in N words from S in byte unit to Nibble unit of Hexadecimal BIN so to save in D	O	O
	HEXP	—HEXP S D N—			
String Extract from Right	RIGHT	—RIGHT S D N—	Extracts N string from S string's final letter to save in starting D	O	O
	RIGHTP	—RIGHTP S D N—			
String Extract from Left	LEFT	—LEFT S D N—	Extracts N string from S string's first letter to save in starting D	O	O
	LEFTP	—LEFTP S D N—			
String Random Extract	MID	—MID S1 S2 D—	Extracts string which conforms to S2 condition among S1 string to save in starting D	O	O
	MIDP	—MIDP S1 S2 D—			



(continued)

Classification	Designations	Symbol	Description	Support	
				XGK	XGB
String Random Replace	REPLACE	— REPLACE S1 D S2 —	Processes S1 String as applicable to S2 Condition to save in D String	O	O
	REPLACEP	— REPLACEP S1 D S2 —			
String Find	FIND	— FIND S1 S2 D N —	Finds identical String to S2 in S1 ~ N data to save the absolute position in D	O	O
	FINDP	— FIND S1 S2 D N —			
Parse Real Number to BCD	RBCD	— RBCD S1 S2 D —	Adjusts Floating decimal point point Real Number Data S1 to S2 place to convert to BCD, and then to save in D	O	X
	RBCDP	— RBCDP S1 S2 D —			
	LBCD	— LBCD S1 S2 D —	Adjusts Floating decimal point point Double Real Number Data S1 to S2 place to convert to BCD, and then to save in D		
	LBCDP	— LBCDP S1 S2 D —			
Convert BCD Data to Real Number	BCDR	— BCDR S1 S2 D —	Adjusts BCD Data S1 to S2 place to convert to Floating decimal point point Real Number, and then to save in D	O	X
	BCDRP	— BCDRP S1 S2 D —			
Convert BCD Data to Real Number	BCDL	— BCDR S1 S2 D —	Adjusts BCD Data S1 to S2 place to convert to Floating decimal point point Double Real Number, and then to save in D		
	BCDLP	— BCDRP S1 S2 D —			

### Appendix 3 Instruction List

(16) Special function instruction

Classification	Designations	Symbol	Description	Support	
				XGK	XGB
SIN Operation	SIN		$\text{SIN}(S+1,S) \longrightarrow (D+1,D)$	○	○
	SINP				
COS Operation	COS		$\text{COS}(S+1,S) \longrightarrow (D+1,D)$	○	○
	COSP				
TAN Operation	TAN		$\text{TAN}(S+1,S) \longrightarrow (D+1,D)$	○	○
	TANP				
ATAN Operation	ATAN		$\text{SIN}^{-1}(S+1,S) \longrightarrow (D+1,D)$	○	○
	ATANP				
RAD Conversion	RAD		$\text{COS}^{-1}(S+1,S) \longrightarrow (D+1,D)$	○	○
	RADP				
Angle Conversion	DEG		$\text{TAN}^{-1}(S+1,S) \longrightarrow (D+1,D)$	○	○
	DEGP				
RAD Conversion	RAD		$(S+1,S) \longrightarrow (D+1,D)$ Converts angle to radian	○	○
	RADP				
Angle Conversion	DEG		$(S+1,S) \longrightarrow (D+1,D)$ Converts radian to angle	○	○
	DEGP				
Square Root Operation	SQRT		$\sqrt{(S+1,S)} \longrightarrow (D+1,D)$	○	○
	SQRTP				

(17) Data control instruction

Classification	Designations	Symbol	Description	Support	
				XGK	XGB
Limit Control	LIMIT	$\boxed{\text{LIMIT}} \quad \boxed{S1} \quad \boxed{S2} \quad \boxed{S3} \quad \boxed{D}$	If $S1 < S2$ , then $D = S2$ If $S2 < S1 < S3$ , then $D = S1$ If $S3 < S1$ , then $D = S3$	O	O
	LIMITP	$\boxed{\text{LIMITP}} \quad \boxed{S1} \quad \boxed{S2} \quad \boxed{S3} \quad \boxed{D}$			
	DLIMIT	$\boxed{\text{DLIMIT}} \quad \boxed{S1} \quad \boxed{S2} \quad \boxed{S3} \quad \boxed{D}$			
	DLIMITP	$\boxed{\text{DLIMITP}} \quad \boxed{S1} \quad \boxed{S2} \quad \boxed{S3} \quad \boxed{D}$			
Dead-zone Control	DZONE	$\boxed{\text{DZONE}} \quad \boxed{S1} \quad \boxed{S2} \quad \boxed{S3} \quad \boxed{D}$	If $S1 < -S2$ , then $D = S1 + S2 - S2(S3/100)$ If $-S2 < S1 < S2$ , then $D = (S3/100)S1$ If $S1 < S2$ , then $D = S1 - S2 + S2(S3/100)$	O	O
	DZONEP	$\boxed{\text{DZONEP}} \quad \boxed{S1} \quad \boxed{S2} \quad \boxed{S3} \quad \boxed{D}$			
	DDZONE	$\boxed{\text{DDZONE}} \quad \boxed{S1} \quad \boxed{S2} \quad \boxed{S3} \quad \boxed{D}$			
	DDZONEP	$\boxed{\text{DDZONEP}} \quad \boxed{S1} \quad \boxed{S2} \quad \boxed{S3} \quad \boxed{D}$			
	DZONES	$\boxed{\text{VZONE}} \quad \boxed{S1} \quad \boxed{S2} \quad \boxed{S3} \quad \boxed{D}$	If $S2 > S1$ , then $D = S1 - S2$ If $S3 < S1$ , then $D = S1 - S3$ If $S2 \leq S1 \leq S3$ , then $D = 0$ If $(S2 = S3) < S1$ , then $D = S1 - S3$ If $(S2 = S3) > S1$ , then	O	O
	DZONESP	$\boxed{\text{VZONEP}} \quad \boxed{S1} \quad \boxed{S2} \quad \boxed{S3} \quad \boxed{D}$			
	DDZONES	$\boxed{\text{DVZONE}} \quad \boxed{S1} \quad \boxed{S2} \quad \boxed{S3} \quad \boxed{D}$			
	DDZONESP	$\boxed{\text{DVZONEP}} \quad \boxed{S1} \quad \boxed{S2} \quad \boxed{S3} \quad \boxed{D}$			
Vertical-zone Control Built-in	VZONE	$\boxed{\text{PIDRUN}} \quad \boxed{N}$	If $S1 < -S2(S3/100)$ , then $D = S1 - S2 + S2(S3/100)$ If $-S2(S3/100) < S1 < S2(S3/100)$ , then $D = (100/S3)S1$ If $S1 < S2(S3/100)$ , then $D = S1 + S2 - S2(S3/100)$	O	O
	VZONEP	$\boxed{\text{PIDPAUSE}} \quad \boxed{N}$		O	X
	DVZONE	$\boxed{\text{PIDPRMT}} \quad \boxed{S} \quad \boxed{N}$		O	X
	DVZONEP	$\boxed{\text{PIDRUN}} \quad \boxed{N}$		X	O
PID Control Instruction	PIDRUN	$\boxed{\text{PIDPRMT}} \quad \boxed{S} \quad \boxed{N}$	Operates PID Loop N	X	O
	PIDPAUSE	$\boxed{\text{PIDPRMT}} \quad \boxed{S} \quad \boxed{N}$	Stops PID Loop N momentarily	X	O
	PIDPRMT	$\boxed{\text{PIDPRMT}} \quad \boxed{S} \quad \boxed{N}$	Changes PID Loop N's Parameter. ( SV(word) / Ts(word) / Kp(real) / Ti(real) / Td(real) )	X	O

### Appendix 3 Instruction List

(18) Time related instruction

Classification	Designations	Symbol	Description	Support	
				XGK	XGB
Date/Time Data Read	DATERD		Reads PLC Time to save in D ~ D+6 (Yr/Mn/Dt/Hr/Mn/Sd/Day)	O	X
	DATERDP				
Date/Time Data Write	DATEWR		Input S ~ S+6's Time Data in PLC (Yr/Mn/Dt/Hr/Mn/Sd/Day)	O	X
	DATEWRP				
Time Data Increase	ADDCLK		Adds S1 ~ S1+2 & S2 ~ S2+2 Time Data to save in D ~ D+2 in Time Data format (Hr/Mn/Sd)	O	X
	ADDCLKP				
Time Data Decrease	SUBCLK		Extracts S2 ~ S2+2's Time Data from S1 ~ S1+2 to save in D ~ D+2 in Time Data format (Hr/Mn/Sd)	O	X
	SUBCLKP				
Time Data Format Conversion	SECOND		Converts Time Data S ~ S+2 to seconds to save in double word D	O	X
	SECONDP				
	HOUR		Converts the seconds saved in double word S to Hr/Mn/Sd to save in D ~ D+2	O	X
	HOURP				

(19) Divergence instruction

Classification	Designations	Symbol	Description	Support	
				XGK	XGB
Divergence Instruction	JMP		Jumps to LABEL location	O	O
	LABEL		Jumps and designates the location to move to		
Subroutine Call Functional	CALL		Calls Function applicable to LABEL	O	O
	CALLP				
	SBRT		Designates Function to be called by CALL		
	RET		RETURN		

(20) 루프 명령

Classification	Designations	Symbol	Description	Support	
				XGK	XGB
Loop Instruction	FOR		Operates FOR~NEXT section n times	○	○
	NEXT				
	BREAK		Escapes from FOR~NEXT section		

(21) 플래그 제어 명령

Classification	Designations	Symbol	Description	Support	
				XGK	XGB
Carry Flag Set, Reset	STC		Carry Flag( F0112 ) SET	○	○
	CLC		Carry Flag( F0112 ) RESET		
Error Flag Clear	CLE		Error Latch Flag(F0115) RESET	○	○

(22) 시스템 명령

Classification	Designations	Symbol	Description	Support	
				XGK	XGB
Error Display	FALS		Self Diagnosis (Error Display )	○	○
Scan Cluck	DUTY		On during n1 Scan, Off during n2 Scan	○	○
Time Cluck	TFLK		On during S1 set time, Off during S2 set time	○	○
WDT Initialize	WDT		Watch Dog Timer Clear	○	○
	WDTP				
Output Control	OUTOFF		All Output Off	○	○
Operation Stop	STOP		Finishes applicable scan to end PLC Operation	○	○
Emergent Operation Stop	ESTOP		Ends PLC operation right after Instruction executed	○	○

(23) 인터럽트 관련 명령

Classification	Designations	Symbol	Description	Support	
				XGK	XGB
All Channels Interrupt Setting	EI		All Channels Interrupt allowed	○	○
	DI		All Channel Interrupt prohibited		
Individual Channel Interrupt Setting	EIN		Individual Channel Interrupt allowed	○	○
	DIN		Individual Channel Interrupt prohibited		

### Appendix 3 Instruction List

(24) Sign reversion instruction

Classification	Designations	Symbol	Description	Support	
				XGK	XGB
2's complement	NEG	$\overline{\text{NEG}} \quad \text{D}$	Saves D value again in D with 2's complement taken	○	○
	NEGP	$\overline{\text{NEGP}} \quad \text{D}$			
	DNEG	$\overline{\text{DNEG}} \quad \text{D}$	Saves (D+1,D) value again in (D+1,D) with 2's complement taken		
	DNEGP	$\overline{\text{DNEGP}} \quad \text{D}$			
Real Number Data Sign Reverse	RNEG	$\overline{\text{RNEG}} \quad \text{D}$	Reverses D Real Number Sign then to save again	○	○
	RNEGP	$\overline{\text{RNEGP}} \quad \text{D}$			
	LNEGR	$\overline{\text{LNEGR}} \quad \text{D}$	Reverses D Double Real Number Sign then to save again		
	LNEGP	$\overline{\text{LNEGP}} \quad \text{D}$			
Absolute Value Operation	ABS	$\overline{\text{ABS}} \quad \text{D}$	Converts D highest Bit to 0	○	○
	ABSP	$\overline{\text{ABSP}} \quad \text{D}$			
	DABS	$\overline{\text{DABS}} \quad \text{D}$	Converts (D+1,D) highest Bit to 0		
	DABSP	$\overline{\text{DABSP}} \quad \text{D}$			

(25) File related instruction



Classification	Designations	Symbol	Description	Support	
				XGK	XGB
Block Conversion	RSET	$\overline{\text{RSET}} \quad \text{S}$	Changes Block Number of file register to S Number	○	X
	RSETP	$\overline{\text{RSETP}} \quad \text{S}$			
Flash Word Data Transfer	EMOV	$\overline{\text{EMOV}} \quad \text{S1 S2 D}$	Transfers S2 word data in S1 Block to D	○	X
	EMOVP	$\overline{\text{EMOVP}} \quad \text{S1 S2 D}$			
Flash Double Word Data Transfer	EDMOV	$\overline{\text{EDMOV}} \quad \text{S1 S2 D}$	Transfers S2+1, S2 double word data in S1 Block to D+1, D		
	EDMOVP	$\overline{\text{EDMOVP}} \quad \text{S1 S2 D}$			
Block Read	EBREAD	$\overline{\text{EBREAD}} \quad \text{S1 S2}$	Reads Flash Memory Block	○	X
Block Write	EBWRITE	$\overline{\text{EBWRITE}} \quad \text{S1 S2}$	Writes Flash Memory Block	○	X
Block Compare	EBCMP	$\overline{\text{EBCMP}} \quad \text{S1 S2 D1 D2}$	Compares R Area's Bank with Flash Area's Block	○	X

## Appendix 3.4 Special/Communication Instruction

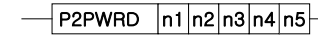
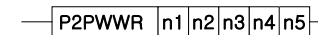
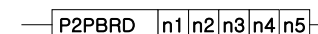
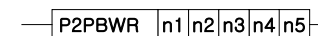
### (1) Communication Instruction

Classification	Designations	Symbol	Description	Support	
				XGK	XGB
Station No. Set	P2PSN		Sets opposite station No. for P2P Communication. n1:P2P No., n2:Block, n3:Station No.	○	X
Read Area Set (WORD)	P2PWRD		Sets word data Read Area n1:P2P No., n2:Block, n3:Variable sequence, n4:Variable Size, n5:Device	○	X
Write Area Set (WORD)	P2PWWR		Sets word data Write Area n1:P2P No., n2:Block, n3:Variable sequence, n4:Variable Size, n5:Device	○	X
Read Area Set (BIT)	P2PBRD		Sets bit data Read Area n1:P2P No., n2:Block, n3:Variable sequence, n4: Variable Size, n5:Device	○	X
Write Area Set (BIT)	P2PBWR		Sets bit data Write Area n1:P2P No., n2:Block, n3:Variable sequence, n4:Variable Size, n5:Device	○	X

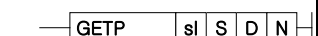
### (2) Special/Communication Instruction

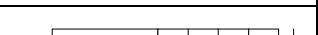
Classification	Designations	Symbol	Description	Support	
				XGK	XGB
Special Module Read/Write	GET		Reads data of special module memory is installed on	○	○
	GETP				
	PUT		Writes data on special module memory is installed on	○	○
	PUTP				

## Appendix 3 Instruction List

### (3) Exclusive position control instruction

Classification	Designations	Symbol	Description	Support	
				XGK	XGB
Return to Origin Point	ORG	<code>— [ORG] [sl] [ax] —</code>	Instructions Positioning Module's ax axis installed on sl slot to return to Origin Point	○	○
Floating Origin Point	FLT	<code>— [FLT] [sl] [ax] —</code>	Instructions Positioning Module's ax axis installed on sl slot to set Floating Origin Point	○	○
Direct Start	DST	<code>— [DST] [sl] [ax] [n1] [n2] [n3] [n4] [n5] —</code>	Instructions Positioning Module's ax axis installed on sl slot to start directly with Target Position(n1), Target Speed(n2), Dwell Time(n3), M Code(n4) & Control Word(n5)	○	○
Indirect Start	IST	<code>— [IST] [sl] [ax] [n] —</code>	Instructions Positioning Module's ax axis installed on sl slot to start n step indirectly	○	○
Linear Interpolation	LIN	<code>— [LIN] [sl] [ax] [n1] [n2] —</code>	Instructions Positioning Module's ax axis installed on sl slot to let n2 axes operate n1 step by Linear Interpolation	○	○
Circular Interpolation	CIN	<code>— [CIN] [sl] [ax] [n1] [n2] —</code>	Instructions Positioning Module's ax axis installed on sl slot to let n2 axes operate n1 step by Circular Interpolation	○	X
Simultaneous Start	SST	<code>— [SST] [sl] [ax] [n1] [n2] [n3] [n4] —</code>	Instructions Positioning Module's ax axis installed on sl slot to let n4 axes operate n1(X), n2(Y), n3(Z) steps by Simultaneous Start	○	○
Speed/Position Control Switch	VTP	<code>— [VTP] [sl] [ax] —</code>	Instructions Positioning Module's ax axis installed on sl slot to switch Speed to Position.	○	○
Position/Speed Control Switch	PTV	<code>— [PTV] [sl] [ax] —</code>	Instructions Positioning Module's ax axis installed on sl slot to switch Position to Speed Control	○	○
Decelerated Stop	STP	<code>— [STP] [sl] [ax] —</code>	Instructions Positioning Module's ax axis installed on sl slot to stop as decelerated.	○	○
Skip	SKP	<code>— [SKP] [sl] [ax] —</code>	Instructions Positioning Module's ax axis installed on sl slot to skip	○	X
Position Synchronization	SSP	<code>— [SSP] [sl] [ax] [n1] [n2] [n3] —</code>	Instructions Positioning Module's ax axis installed on sl slot to do Position Sync with main axis of n3, n1 sync-positioned and n2 step operated	○	○
Speed Synchronization	SSS	<code>— [SSS] [sl] [ax] [n1] [n2] [n3] —</code>	Instructions Positioning Module's ax axis installed on sl slot to do Speed Sync with main axis of n3, n1 master and n2 slave	○	○
Position Override	POR	<code>— [POR] [sl] [ax] [n] —</code>	Instructions Positioning Module's ax axis installed on sl slot to override Position to change the target position to n	○	○



## Appendix 3 Instruction List

(continued)

Classification	Designations	Symbol	Description	Support	
				XGK	XGB
Speed Override	SOR	— SOR   sl   ax   n	Instructions Positioning Module's ax axis installed on sl slot to override Speed to change the target speed to n	○	○
Position specified Speed Override	PSO	— PSO   sl   ax   n	Instructions Positioning Module's ax axis installed on sl slot to override position specified speed to change the target speed to n2 from n1 position	○	○
Continuous Operation	NMV	— NMV   sl   ax	Instructions Positioning Module's ax axis installed on sl slot to operate continuously to n step	○	X
Inching	INCH	— INCH   sl   ax   n	Instructions Positioning Module's ax axis installed on sl slot to inch to n position	○	○
Return to Position Previous to Manual Operation	RTP	— RTP   sl   ax	Instructions Positioning Module's ax axis installed on sl slot to return to position previous to manual operation	○	X
Operation Step Change	SNS	— IST   sl   ax   n	Instructions Positioning Module's ax axis installed on sl slot to change operation step to n	○	○
Repeated Operation Step Change	SRS	— SRS   sl   ax   n	Instructions Positioning Module's ax axis installed on sl slot to change repeated operation step to n	○	X
M Code Off	MOF	— MOF   sl   ax	Instructions Positioning Module's ax axis installed on sl slot to make M code off	○	○
Present Position Change	PRS	— PRS   sl   ax   n	Instructions Positioning Module's ax axis to change present position to n	○	○
Zone Allowed	ZOE	— ZOE   sl   ax	Allows zone output of Positioning Module installed on sl slot	○	X
Zone Prohibited	ZOD	— ZOD   sl   ax	Prohibits zone output of Positioning Module installed on sl slot	○	X
Encoder Value change	EPRS	— EPRS   sl   ax   n	Changes Encoder Value of Positioning Module installed on sl slot to n	○	X
Teaching <span style="font-size: small;">티칭</span>	TEA	— TEA   sl   ax   n1   n2   n3   n4	Changes n1 step's target position or speed of Positioning Module's ax axis installed on sl slot	○	X
Teaching Array	TEAA	— TEAA   sl   ax   n1   n2   n3   n4	Changes n1 step's target position or speed of Positioning Module's ax axis installed on sl slot.	○	X
Emergent Stop	EMG	— EMG   sl   ax	Instructions Positioning Module installed on sl slot to perform Emergent Stop	○	○

### Appendix 3 Instruction List

(continued)

Classification	Designations	Symbol	Description	Support	
				XGK	XGB
Error Reset	CLR	— CLR   sl   ax   n   —	Resets Error originated from Positioning Module's ax axis installed on sl slot	O	O
Error History Reset	ECLR	— ECLR   sl   ax   —	Deletes Error History originated from Positioning Module's ax axis installed on sl slot	O	X
Point Operation	PST	— PST   sl   ax   n   —	Performs Point Operation of Positioning Module's ax axis installed on sl slot	O	X
Basic Parameter Teaching	TBP	— TBP   sl   ax   n1   n2   —	Changes n2 to n1 among basic parameters of Positioning Module's ax axis installed on sl slot	O	X
Extended Parameter Teaching	TEP	— TEP   sl   ax   n1   n2   —	Changes n2 to n1 among extended parameters of Positioning Module's ax axis installed on sl slot	O	X
Return to Origin Point Parameter Teaching	THP	— THP   sl   ax   n1   n2   —	Changes n2 to n1 among returned parameters to origin point of Positioning Module's ax axis installed on sl slot	O	X
Manual Operation Parameter Teaching	TMP	— TMP   sl   ax   n1   n2   —	Changes n2 to n1 among manual operation parameters of Positioning Module's ax axis installed on sl slot	O	X
Input Signal Parameter Teaching	TSP	— TSP   sl   ax   n   —	Changes input signal parameter of Positioning Module's ax axis installed on sl slot to the value set in n1	O	X
Common Parameter Teaching	TCP	— TCP   sl   ax   n1   n2   —	Changes n2 to n1 among common parameters of Positioning Module installed on sl slot	O	X
Parameter Save	WRT	— WRT   sl   ax   n   —	Instructions Positioning Module's ax axis installed on sl slot to save present parameter of n axis in flash ROM.	O	O
Present State Read	SRD	— SRD   sl   ax   D   —	Reads and saves present state of Positioning Module's ax axis installed on sl slot in D area of CPU	O	X
Point Operation Step Write	PWR	— PWR   sl   ax   S   n1   —	Writes n1 value of S area of CPU on point operation step area of Positioning Module's ax axis installed on sl slot in	O	X
Plural Teaching Data Write	TWR	— TWR   sl   ax   S   n1   —	Writes n1 value of S area of CPU on plural teaching data area of Positioning Module's ax axis installed on sl slot in	O	X

Appendix 3 Instruction List

---

### Warranty

#### 1. Warranty Period

The product you purchased will be guaranteed for 18 months from the date of manufacturing.

#### 2. Scope of Warranty

Any trouble or defect occurring for the above-mentioned period will be partially replaced or repaired. However, please note the following cases will be excluded from the scope of warranty.

- (1) Any trouble attributable to unreasonable condition, environment or handling otherwise specified in the manual,
- (2) Any trouble attributable to others' products,
- (3) If the product is modified or repaired in any other place not designated by the company,
- (4) Due to unintended purposes
- (5) Owing to the reasons unexpected at the level of the contemporary science and technology when delivered.
- (6) Not attributable to the company; for instance, natural disasters or fire

#### 3. Since the above warranty is limited to PLC unit only, make sure to use the product considering the safety for system configuration or applications.

### Environmental Policy

LS ELECTRIC Co., Ltd supports and observes the environmental policy as below.

#### Environmental Management

LS ELECTRIC considers the environmental preservation as the preferential management subject and every staff of LS ELECTRIC use the reasonable endeavors for the pleasurable environmental preservation of the earth.

#### About Disposal

LS ELECTRIC' PLC unit is designed to protect the environment. For the disposal, separate aluminum, iron and synthetic resin (cover) from the product as they are reusable.





[www.ls-electric.com](http://www.ls-electric.com)

## LS ELECTRIC Co., Ltd.

### ■ Headquarter

LS-ro 127(Hogye-dong) Dongan-gu, Anyang-si, Gyeonggi-Do, 14119, Korea

### ■ Seoul Office

LS Yongsan Tower, 92, Hangang-daero, Yongsan-gu, Seoul, 04386, Korea

Tel: 82-2-2034-4033, 4888, 4703 Fax: 82-2-2034-4588

E-mail: [automation@ls-electric.com](mailto:automation@ls-electric.com)

### ■ Overseas Subsidiaries

#### • LS ELECTRIC Japan Co., Ltd. (Tokyo, Japan)

Tel: 81-3-6268-8241 E-Mail: [japan@ls-electric.com](mailto:japan@ls-electric.com)

#### • LS ELECTRIC (Dalian) Co., Ltd. (Dalian, China)

Tel: 86-411-8730-6495 E-Mail: [china.dalian@lselectric.com.cn](mailto:china.dalian@lselectric.com.cn)

#### • LS ELECTRIC (Wuxi) Co., Ltd. (Wuxi, China)

Tel: 86-510-6851-6666 E-Mail: [china.wuxi@lselectric.com.cn](mailto:china.wuxi@lselectric.com.cn)

#### • LS ELECTRIC Middle East FZE (Dubai, U.A.E.)

Tel: 971-4-886-5360 E-Mail: [middleeast@ls-electric.com](mailto:middleeast@ls-electric.com)

#### • LS ELECTRIC Europe B.V. (Hoofddorp, Netherlands)

Tel: 31-20-654-1424 E-Mail: [europartner@ls-electric.com](mailto:europartner@ls-electric.com)

#### • LS ELECTRIC America Inc. (Chicago, USA)

Tel: 1-800-891-2941 E-Mail: [sales.us@lselectricamerica.com](mailto:sales.us@lselectricamerica.com)

#### • LS ELECTRIC Turkey Co., Ltd.

Tel: 90-212-806-1225 E-Mail: [turkey@ls-electric.com](mailto:turkey@ls-electric.com)

### ■ Overseas Branches

#### • LS ELECTRIC Tokyo Office (Japan)

Tel: 81-3-6268-8241 E-Mail: [tokyo@ls-electric.com](mailto:tokyo@ls-electric.com)

#### • LS ELECTRIC Beijing Office (China)

Tel: 86-10-5095-1631 E-Mail: [china.auto@lselectric.com.cn](mailto:china.auto@lselectric.com.cn)

#### • LS ELECTRIC Shanghai Office (China)

Tel: 86-21-5237-9977 E-Mail: [china.auto@lselectric.com.cn](mailto:china.auto@lselectric.com.cn)

#### • LS ELECTRIC Guangzhou Office (China)

Tel: 86-20-3818-2883 E-Mail: [china.auto@lselectric.com.cn](mailto:china.auto@lselectric.com.cn)

#### • LS ELECTRIC Chengdu Office (China)

Tel: 86-28-8670-3201 E-Mail: [china.auto@lselectric.com.cn](mailto:china.auto@lselectric.com.cn)

#### • LS ELECTRIC Qingdao Office (China)

Tel: 86-532-8501-2065 E-Mail: [china.auto@lselectric.com.cn](mailto:china.auto@lselectric.com.cn)

#### • LS ELECTRIC Nanjing Office (China)

Tel: 86-25-8467-0005 E-Mail: [china.auto@lselectric.com.cn](mailto:china.auto@lselectric.com.cn)

#### • LS ELECTRIC Bangkok Office (Thailand)

Tel: 66-90-950-9683 E-Mail: [thailand@ls-electric.com](mailto:thailand@ls-electric.com)

#### • LS ELECTRIC Jakarta Office (Indonesia)

Tel: 62-21-2933-7614 E-Mail: [indonesia@ls-electric.com](mailto:indonesia@ls-electric.com)

#### • LS ELECTRIC Moscow Office (Russia)

Tel: 7-499-682-6130 E-Mail: [info@lselectric-ru.com](mailto:info@lselectric-ru.com)

#### • LS ELECTRIC America Western Office (Irvine, USA)

Tel: 1-949-333-3140 E-Mail: [america@ls-electric.com](mailto:america@ls-electric.com)

### Disclaimer of Liability

LS ELECTRIC has reviewed the information in this publication to ensure consistency with the hardware and software described. However, LS ELECTRIC cannot guarantee full consistency, nor be responsible for any damages or compensation, since variance cannot be precluded entirely. Please check again the version of this publication before you use the product.

© LS ELECTRIC Co., Ltd 2015 All Right Reserved.

2022.09