

The right choice for the ultimate yield!

LS ELECTRIC strives to maximize your profits in gratitude for choosing us as your partner.

## Programmable Logic Control

# XGB Cnet I/F

### XGT Series

### User Manual

Main Unit	XBM	S TYPE	Cnet I/F	XBL-C41A
Built-in Cnet	XBC/XEC	E TYPE	module	XBL-C21A
	XBC/XEC	S TYPE		
	XBC/XEC	SU TYPE		
	XBC/XEC	H TYPE		

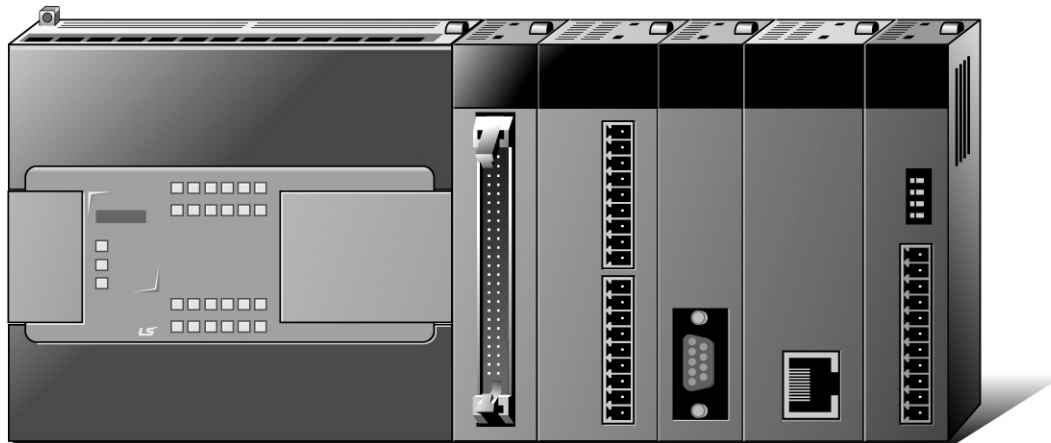
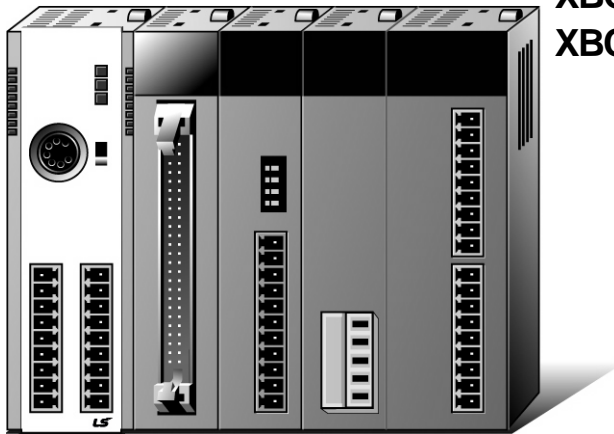

### Safety Instructions

- Read this manual carefully before installing, wiring, operating, servicing or inspecting this equipment.
- Keep this manual within easy reach for quick reference.

**LS**ELECTRIC

## Before using the product ...

For your safety and effective operation, please read the safety instructions thoroughly before using the product.

- ▶ Safety Instructions should always be observed in order to prevent accident or risk with the safe and proper use the product.
- ▶ Instructions are divided into “Warning” and “Caution”, and the meaning of the terms is as follows.



### **Warning**

This symbol indicates the possibility of serious injury or death if some applicable instruction is violated.



### **Caution**

This symbol indicates the possibility of severe or slight injury, and property damages if some applicable instruction is violated.

Moreover, even classified events under its caution category may develop into serious accidents relying on situations. Therefore we strongly advise users to observe all precautions properly just like warnings.

- ▶ The marks displayed on the product and in the user’s manual have the following meanings.



Be careful! Danger may be expected.



Be careful! Electric shock may occur.

- ▶ The user’s manual even after read shall be kept available and accessible to any user of the product.

## Safety Instructions for Design Process

### **Caution**

- ▶ **Design the analog input / output signal or pulse input / output line at least 100mm away from high voltage line or power line so that it is not affected by noise or magnetic field change.** It may cause malfunction due to noise.
- ▶ **If there is a lot of vibration in the installation environment, take measures to prevent direct vibration from being applied to the PLC.** It may cause electric shock, fire or malfunction.
- ▶ **If metallic dust is present in the installation environment, take measures to prevent metallic dust from entering the product.** It may cause electric shock, fire or malfunction.

## Safety Instructions on Installation Process

### **Caution**

- ▶ **Use PLC only in the environment specified in PLC manual or general standard of datasheet.**  
If not, electric shock, fire, abnormal operation of the product may be caused.
- ▶ **Before install or remove the module, be sure PLC power is off.** If not, electric shock or damage on the product may be caused.
- ▶ **Be sure that every module is securely attached after adding a module or an extension connector.** If the product is installed loosely or incorrectly, abnormal operation, error or dropping may be caused. In addition, contact failures under poor cable installation will be causing malfunctions as well.
- ▶ **Make sure that the I / O connector is securely fastened.** It may cause wrong input or output.

## Safety Instructions for Wiring Process

### **Warning**

- ▶ **Prior to wiring works, make sure that every power is turned off.** If not, electric shock or damage on the product may be caused.

### **Caution**

- ▶ **Check rated voltages and terminal arrangements in each product prior to its wiring process.** Applying incorrect voltages other than rated voltages and misarrangement among terminals may cause fire or malfunctions.
- ▶ **Secure terminal screws tightly applying with specified torque.** If the screws get loose, short circuit, fire or abnormal operation may be caused. Securing screws too tightly will cause damages to the module or malfunctions, short circuit, and dropping.
- ▶ **Be sure to earth to the ground using Class 3 wires for PE terminals which is exclusively used for PLC.** If the terminals not grounded correctly, abnormal operation or electric shock may be caused.
- ▶ **Don't let any foreign materials such as wiring waste inside the module while wiring,** which may cause fire, damage on the product or abnormal operation.

## Safety Instructions for Test-Operation and Maintenance

### **Warning**

- ▶ **Don't touch the terminal when powered.** Electric shock or abnormal operation may occur.
- ▶ **Prior to cleaning or tightening the terminal screws, let all the external power off including PLC power.** If not, electric shock or abnormal operation may occur.

### **Caution**

- ▶ **Do not make modifications or disassemble each module.**  
Fire, electric shock or abnormal operation may occur.
- ▶ **Prior to installing or disassembling the module, let all the external power off including PLC power.** If not, electric shock or abnormal operation may occur.
- ▶ **Keep any wireless equipment such as walkie-talkie or cell phones at least 30cm away from PLC.** If not, abnormal operation may be caused.

## Safety Instructions for Waste Disposal

### **Caution**

- ▶ **Product or battery waste shall be processed as industrial waste.** The waste may discharge toxic materials or explode itself.

# Revision History

Version	Date	Remark	Page
V 1.0	2006.6	1. First Edition	-
V 1.1	2007.7	1. Position and Special function contents separated (1) Position function contents separated (position part published) (2) PID control and Ch. 12 Analog IO module contents separated 2. Contents added (1) Naming standard added (2) Caution when selecting IO module added (3) Installation and wiring contents added 3. Content modified (1) Safety instruction modified (2) System Configuration modified (3) High speed counter function modified (4) External dimension modified	- - 2-3 ~ 2-6 7-1 ~ 7-6 10-1 ~ 10-18 1 ~ 6 2-7 ~ 2-10 8-6 ~ 8-8 App. 2-1 ~ 2-4
V 1.2	2008.3	1. XGB compact type 'H' type added 2. Built-in communication content separated (1) Ch.9 built-in communication function separated (Cnet I/F user manual)	- Ch. 9
V 1.3	2010.3	1. XEC compact type added	-
V 1.4	2010.5	1. Standard format applied 2. Modbus protocol added 3. Contents changed (1) Ch. 5 Communication function → Ch. 6 Server function and P2P service (2) Ch. 6 Remote connection → Ch. 5 Remote connection	- Ch. 8 Ch. 5, Ch. 6
V 1.5	2013.4	1. Main unit added (1) XBC/XEC 'E' type (2) XBC/XEC 'S/SU' type (3) XBC/XEC 'H' type 2. Contents added (1) 'NOTE' for XGT Dedicated Protocol	2-4 ~ 2-7 7-6
V 1.6	2014.2	1. LS Bus Protocol added 2. Ch.8 ~ Ch.12 → Ch.9 ~ Ch.13 3. Modified available device type	Ch.8 Ch.9 ~ Ch.13 Ch.7
V1.7	2014.11	1. Ch.6 Server function and P2P service (1) Added UDATA instruction description	Ch6

		2. Ch.11 Example program (1) Example of sending SMS by using CDMA modem	Ch11
V1.8	2015.1	XG5000 V4.0 UI Updated	Entire
V1.9	2015.6	Modified example of CDMA modem	11-32 ~ 11-33
V2.0	'20.06	Corporate Identity Changed (LSIS→LS ELECTRIC)	Entire
V2.1	'22.08	Homepage address changed	Entire

## About User's manual

Thank you for purchasing PLC of LS ELECTRIC Co., Ltd.

Before use, make sure to carefully read and understand the User's Manual about the functions, performances, installation and programming of the product you purchased in order for correct use and importantly, let the end user and maintenance administrator to be provided with the User's Manual.

The User's Manual describes the product. If necessary, you may refer to the following description and order accordingly. In addition, you may connect our website (<http://www.ls-electric.com/>) and download the information as a PDF file.

### Relevant User's Manuals

Title	Description	No. of User's Manual
XG5000 User's Manual	It describes how to use XG5000 software especially about online functions such as programming, printing, monitoring and debugging by using XGT series products.	10310000512
XG5000 User's Manual	It describes how to use XG5000 software especially about online functions such as programming, printing, monitoring and debugging by using XGB(IEC)	10130000834
XGK/XGB Series Instruction	It describes how to use the instructions for programming using XGK/XGB series.	10310000510
XGI/XGR/XEC Series Instruction	It describes how to use the instructions for programming using XGB(IEC) series.	10130000833
XGB Hardware User's Manual	It describes how to use the specification of power/input /output/expansion modules, system configuration and built-in High-speed counter for XGB basic unit.	10310000926
XGB Hardware User's Manual (IEC)	It describes how to use the specification of power/input /output/expansion modules, system configuration and built-in High-speed counter for XGB basic unit.	10130001059
XGB Analog User's Manual	It describes how to use the specification of analog input/analog output/temperature input module, system configuration and built-in PID control for XGB basic unit.	10310000920
XGB Position User's Manual	It describes how to use built-in positioning function for XGB unit.	10310000927



# © Contents ©

## Chapter 1 General----- 1-1 ~ 1-2

- 1.1 General ----- 1-1
- 1.2 Characteristic----- 1-2

## Chapter 2 Specification ----- 2-1 ~ 2-8

- 2.1 General Specification ----- 2-1
- 2.2 Performance Specification ----- 2-2
- 2.3 Name and Function of each part ----- 2-4

## Chapter 3 System Configuration-----3-1~ 3-9

- 3.1 XGB System Configuration ----- 3-1
  - 3.1.1 "H" type system configuration ----- 3-1
  - 3.1.2 "S" type System Configuration ----- 3-2
- 3.2 Available System Configuration ----- 3-3
  - 3.2.1 1:1 Connection between PC (HMI) (No modem) ----- 3-3
  - 3.2.2 1:1 Dedicated modem connection with PC (HMI) ----- 3-6
  - 3.2.3 Modem connection with PC and communication between Cnet I/F modules ----- 3-6
  - 3.2.4 Dedicated communication with PC (HMI) and different type RS-422 communication ---- 3-7
  - 3.2.5 Optical modem communication for moving material communication ----- 3-8
  - 3.2.6 Wireless modem communication for communication between revolution bodies ----- 3-9

## Chapter 4 Basic Setting ----- 4-1 ~ 4-9

- 4.1 Setting Sequence of Product ----- 4-1
- 4.2 PLC Type Setting and How to Register Communication Module ----- 4-2
  - 4.2.1 Making new project ----- 4-2
  - 4.2.2 In case of off line, method on Cnet I/F module registration ----- 4-3
  - 4.2.3 How to register Cnet I/F module in case of online ----- 4-3
  - 4.2.4 Read parameter saved in PLC ----- 4-5
- 4.3 How to Set Basic Parameter ----- 4-6
  - 4.3.1 Setting item ----- 4-7
  - 4.3.2 Setting method ----- 4-9

## Chapter 5 Remote Connection ----- 5-1 ~ 5-11

- 5.1 Remote connection ----- 5-1
  - 5.1.1 General ----- 5-1
  - 5.1.2 XG5000 remote connection ----- 5-1
  - 5.1.3 Remote connection between Cnet I/F modules----- 5-8

<b>Chapter 6 Server function and P2P service</b> -----	6-1 ~ 6-39
--------------------------------------------------------	------------

6.1 Server Modbus Service-----	6-1
6.1.1 XGT dedicated server-----	6-2
6.1.2 Modbus server -----	6-2
6.2 P2P Service -----	6-4
6.2.1 General -----	6-4
6.2.2 P2P parameter configuration -----	6-5
6.2.3 Channel information -----	6-6
6.2.4 Block information -----	6-7
6.3 XGT Client Service -----	6-8
6.3.1 Channel Setting -----	6-8
6.3.2 P2P Block Setting -----	6-9
6.3.3 Parameter Write -----	6-10
6.3.4 Enable Link -----	6-10
6.3.5 Diagnosis -----	6-11
6.4 Modbus Client Service -----	6-12
6.4.1 Channel Setting -----	6-12
6.4.2 P2P Block Setting -----	6-13
6.4.3 Parameter Write -----	6-14
6.4.4 Enable Link -----	6-15
6.4.5 Diagnosis -----	6-15
6.5 User Frame Definition -----	6-16
6.5.1 Structure of user definition frame -----	6-16
6.5.2 Channel Setting -----	6-19
6.5.3 Writing transmission frame -----	6-19
6.5.4 Writing receive frame -----	6-22
6.5.6 Parameter Write -----	6-25
6.5.7 Enable Link -----	6-25
6.5.8 Diagnosis -----	6-26
6.6 UDATA Instruction -----	6-27
6.6.1 SEND_UDATA [IEC] -----	6-27
6.6.2 RCV_UDATA [IEC] -----	6-29
6.6.3 SEND_DTR [IEC] -----	6-30
6.6.4 SEND_RTS [IEC] -----	6-31
6.6.5 SNDUDATA [MK] -----	6-32
6.6.6 RCVUDATA [MK] -----	6-34
6.6.7 SENDDTR [MK] -----	6-36
6.6.8 SENDRTS [MK] -----	6-38

**Chapter 7 XGT Dedicated Protocol ----- 7-1 ~ 7-19**

7.1 XGT Dedicated Protocol -----	7-1
7.1.1 Frame structure -----	7-2
7.1.2 List of commands -----	7-3
7.1.3 Data type -----	7-4
7.2 Detail of instruction -----	7-6
7.2.1 Individual reading of device (R(r)SS) -----	7-6
7.2.2 Direct variable continuous reading (R(r)SB) -----	7-9
7.2.3 Individual writing of device (W(w)SS) -----	7-12
7.2.4 Continuous writing of device (W(w)SB) -----	7-14
7.2.5 Monitor variable register (X##) -----	7-16
7.2.6 Monitor execution (Y##) -----	7-18

**Chapter 8 LS Bus Protocol ----- 8-1 ~ 8-6**

8.1 LS Bus Protocol -----	8-1
8.1.1 Frame structure -----	8-1
8.1.2 List of commands -----	8-2
8.2 Detail of instruction -----	8-3
8.2.1 Continuous writing to inverter device (W) -----	8-3
8.2.2 Inverter continuous reading (R) -----	8-5

**Chapter 9 Modbus Communication ----- 9-1 ~ 9-16**

9.1 General -----	9-1
9.2 Modbus Protocol -----	9-1
9.2.1 Kind of modbus protocol-----	9-1
9.2.2 Structure of modbus protocol-----	9-1
9.3 Structure of Frame -----	9-3
9.3.1 Structure of Frame in the ASCII mode -----	9-3
9.3.2 Frame structure in the RTU mode -----	9-4
9.3.3 Data and expression of address -----	9-5
9.4 Modbus Protocol-----	9-6
9.4.1 Reading data of bit type at the bit output (01) -----	9-6
9.4.2 Read Input Status (02) -----	9-8
9.4.3 Read Holding Registers (03) -----	9-9
9.4.4 Read Input Registers (04) -----	9-10
9.4.5 Force Single Coil (05) -----	9-11
9.4.6 Preset Single Register (06) -----	9-12
9.4.7 Force Multiple Coils (0F) -----	9-13
9.4.8 Preset Multiple Registers (10) -----	9-15

**Chapter 10 Diagnosis ----- 10-1 ~ 10-9**

10.1	Diagnosis Function of XG5000 -----	10-1
10.1.1	Checking status of main unit -----	10-2
10.1.2	Communication module information -----	10-2
10.1.3	Frame monitor -----	10-3
10.1.4	Status by service -----	10-4
10.2	Trouble Shooting by Error -----	10-7
10.2.1	Trouble shooting when P2P parameter setting error occurs in case of XG5000 connection -----	10-7
10.2.2	Trouble shooting when communication is not done after P2P client setting -	10-7
10.2.3	Trouble shooting when response frame is missed in case of acting as client and using RS-485 -----	10-7
10.2.4	Two response frame are dealt with as unknown when executing frame monitor--	10-8
10.2.5	Unable to analyze TRX frame -----	10-8
10.2.6	Unable to know which one is reason of error, client or server -----	10-8
10.2.7	Communication is not normal or communication is not executed repeatedly -----	10-9

**Chapter 11 Example Program----- 11-1 ~ 11-25**

11.1	Setting of Cnet I/F module in the XG5000 -----	11-1
11.1.1	In case of acting as server -----	11-1
11.1.2	In case of acting as P2P service (client) -----	11-3
11.2	Dedicated Communication Example -----	11-6
11.2.1	Settings of XGT server -----	11-7
11.2.2	Settings of XGT client -----	11-8
11.2.3	Checking the operation -----	11-11
11.3	Modbus Communication Example -----	11-12
11.3.1	Modbus RTU server setting -----	11-13
11.3.2	Setting of Modbus RTU client -----	11-15
11.4	User defined Communication Example -----	11-20
11.4.1	User defined communication example system configuration -----	11-20
11.4.2	User definition communication frame structure -----	11-21
11.4.3	User definition communication parameter setting -----	11-22
11.5	SMS transmission method using the CDMA modem -----	11-26
11.5.1	SMS send message using CDMA modem -----	11-28

**Chapter 12 Installation and Wiring** ----- 12-1 ~ 12-24

12.1 Safety Instruction	12-1
12.1.1 Fail safe circuit	12-3
12.1.2 PLC heat calculation	12-6
12.2 Attachment/Detachment of Modules	12-8
12.2.1 Attachment/Detachment of modules	12-8
12.2.2 Caution in handling	12-12
12.3 Wire	12-13
12.3.1 Power wiring	12-13
12.3.2 I/O Device wiring	12-16
12.4 Channel Operation during Normal Run	12-17
12.5 Communication Interface Connection Method	12-18
12.5.1 RS-232C Interface (XBL-C21A)	12-18
12.5.2 RS-422/485 interface (Built-in communication)	12-20
12.5.3 RS-422 interface (XBL-C41A)	12-21
12.6 Cable Specifications	12-23
12.6.1 Electrical characteristic	12-23
12.5.2 External characteristic	12-23
12.7 Terminal Resistance (In case of using RS-422/485)	12-24

**Chapter 13 Maintenance** ----- 13-1 ~ 13-2

13.1 Maintenance and Inspection	13-1
13.2 Daily Inspection	13-1
13.3 Periodic Inspection	13-2

**Appendix** ----- A1-1 ~ A4-4

Appendix 1 Definition of Terms	A1-1
Appendix 1.1 General Terms	A1-1
Appendix 1.2 Serial Communication Terms	A1-2
Appendix 2 Communication Relay List (L)	A2-1
Appendix 2.1 Communication Relay (L) List	A2-1
Appendix 2.2 Network Register (N) List	A2-4
Appendix 3 Communication Error Code	A3-1
Appendix 3.1 XGT Server Error Code	A3-1
Appendix 3.2 Modbus Server Error Code	A3-2
Appendix 3.3 P2P Client Error Code	A3-2
Appendix 4 Dimension (Unit: mm)	A4-1

## Chapter 1 General

### 1.1 General

This user manual provides the information of Cnet I/F among XGB PLC system network about specification/performance and how to operate. Configuration of user manual is as follows.

Chapter	Item	Content
1	General	Describes configuration of manual, product characteristic and term
2	Specification	Indicates general specification and performance specification of each module used XGB PLC.
3	System configuration	Describes basic communication parameter setting.
4	Basic setting	Describes basic communication setting.
5	Remote connection	Describes CPU connection method by communication channel through XG5000.
6	Server function and P2P service	Describes server for data communication between PLC and P2P parameter setting.
7	XGT dedicated protocol	Describes XGT dedicated communication frame structure.
8	LS Bus Protocol	Describes LS bus protocol structure.
9	Modbus communication	Describes Modbus protocol structure.
10	Diagnosis function	Describes about self-diagnosis by XG5000
11	Example program	Describes example program for communication test.
12	Installation and wiring	Describes installation and wiring.
13	Maintenance	Describes maintenance.
App.1	Term	Describes term used in this manual
App.2	Flag list	Describes parameter setting N area, flag L related with Cnet I/F.
App.3	Communication error code	Describes XGT server, modbus server, P2P error code.
App.4	Dimension	Describes dimension of communication module.

### 1.2 Characteristic

- (1) By using XG5000 operated in window environment, since the user can write communication speed, communication mode (protocol), connection with external device is easy.
- (2) RS-232C 1 port, RS-485 1 port as main unit built-in Cnet is supported. Two type of Cnet I/F module as extension, RS-232C 1 port (XBL-C21A), RS-422(485) 1port (XBL-C41A) is provided.
- (3) It operates independently according to channel, since protocol data written by user is managed by main unit, in case communication module is changed other than communication module, additional setting/download is not necessary.
- (4) Device read/write by using XGT dedicated/modbus/user defined protocol is available.
- (5) It provides communication function in which multidrop, up to 32 connection is available in case of using RS-422/485.
- (6) Setting of diverse communication speed is available.  
(1200,2400,4800,9600,19200,38400,57600,115200bps)
- (7) 1:1 and 1:N communication are available.
- (8) With abundant self-diagnosis, trouble diagnosis is simple.
- (9) It supports dedicated server/client, modbus server/client, user defined communication function.
- (10) In case of XBL-C21A module, modem communication is provided, by which controlling remote PLC is available.

Chapter 2 Specification

**2.1 General Specification**

General specification of XGB PLC is as follows.

No.	Item	Specification	Related specifications			
1	Operating temp.	0°C ~ +55°C				
2	Storage temp.	-25°C ~ +70°C				
3	Operating humidity	5 ~ 95%RH, no dew allowed				
4	Storage humidity	5 ~ 95%RH, no dew allowed				
5	Vibration proof	For discontinuous vibration		IEC 61131-2		
		Frequency	Acceleration		Amplitude	Number
		5≤f< 8.4Hz	-		3.5mm	
		8.4≤f≤150Hz	9.8m/s <sup>2</sup>		-	Each 10 times in X,Y,Z directions
		For continuous vibration				
		Frequency	Acceleration		Amplitude	
5≤f< 8.4Hz	-	1.75mm				
8.4≤f≤150Hz	4.9m/s <sup>2</sup> (0.5G)	-				
6	Impact proof	* Max. impact acceleration: 147m/s <sup>2</sup> (15G) * Authorized time: 11ms * Pulse wave : Sign half-wave pulse (Each 3 times in X,Y,Zdirections)	IEC 61131-2 IEC 60068-2-27			
7	Noise proof	Square wave impulse noise	AC:±1,500V DC: ±900 V	LS ELECTRIC standard		
		Static electric discharging	±4 kV (contact discharging),	IEC 61131-2, IEC 61000-4-2		
		Radiation electromagnetic	80 ~ 1,000MHz, 10 V/m	IEC 61131-2, IEC 61000-4-3		
		Fast Transient /burst	Class Power module Voltage 2kV	Digital/Analog I/O communication interface 1kV	IEC 61131-2, IEC 61000-4-4	
8	Ambient conditions	No corrosive gas or dust				
9	Operating height	2000m or less				
10	Pollution level	2 or less				
11	Cooling type	Natural air cooling				

**Notes**

- [1] IEC (International Electro technical Commission):  
An international nongovernmental organization which promotes internationally cooperated standardization in electric/electronic fields, publishes international standards and manages applicable estimation system related with.
- [2] Pollution level: An index indicating pollution level of the operating environment which decides insulation performance of the devices. For instance, Pollution level 2 indicates the state generally that only non-conductive pollution occurs. However, this state contains temporary conduction due to dew produced.



## 2.2 Performance Specification

### (1) Built-in Cnet performance specification

Performance specification of XGB built-in Cnet is as follows.

Item		Specification	
		Channel 1	Channel 2
Serial communication method		RS-232C	RS-485
Modem connection function		-	-
Operation mode (Operation define by channel)	P2P	Act as communication client - XGT dedicated protocol client - Modbus ASCII/RTU client - User defined communication - LS Bus Client <sup>Notes 1)</sup>	
	Server	- XGT dedicated protocol server - Modbus ASCII/RTU server	
Data type	Data bit	7 or 8	
	Stop bit	1 or 2	
	Parity	Even/Odd/None	
Synchronization type		Asynchronous type	
Transmission speed (bps)		1200/2400/4800/9600/19200/38400/57600/115200 bps available	
Station No. setting		Setting range: 0~255 Max. station No. available: 32 stations	
Transmission distance		Max. 15m	Max. 500m
Diagnosis function		Check available by XG5000 diagnosis service	

### Notes

Note 1) <UDATA for CDMA modem communication applicable version>

Series	XBM	XBCH	XBCSU	XBCS	XBCE	XG5000
Version	-	V2.40 or above	V1.50 or above	-	-	V3.71 or above
Series	XBCEX	XBCEB	XECH	XECSU	XECE	-
Version	-	-	V1.80 or above	V1.40 or above	-	-

Notes 2) <LS Bus Client applicable version>

Series	XBM	XBCH	XBCSU	XBCS	XBCE	XG5000
Version	V3.40 or above	V2.30 or above	V1.40 or above	V1.30 or above	V1.20 or above	V3.69 or above
Series	XBCEX	XBCEB	XECH	XECSU	XECE	-
Version	V1.01 or above	V1.01 or above	V1.70 or above	V1.30 or above	V1.10 or above	-

Note 3) Max. 32 stations are available for consist the client and server. Station number setting range is 0~255

## Chapter 2 Specification

### (2) Extension Cnet performance specification

XGB extension Cnet communication module performance specification is as follows

Item		Specification	
		XBL-C21A	XBL-C41A
Serial communication channel		RS-232C 1 channel	RS-422(485) 1 channel
Modem connection function		External modem connection available	-
Operation mode (Operation definition by port)	P2P	Operates as communication client - XGT dedicated protocol client - Modbus ASCII/RTU client - User defined communication - LS Bus Client	
	Server	- XGT dedicated protocol server - Modbus ASCII/RTU server	
Data type	Data bit	7 or 8	
	Stop bit	1 or 2	
	Parity	Even/Odd/None	
Synchronization type		Asynchronous type	
Transmission speed (bps)		1200/2400/4800/9600/19200/38400/57600/115200 bps available	
Station No. setting		Setting range: 0~255 <sup>Note 1)</sup> Max. station No. available: 32 stations	
Transmission distance		RS-232C: 15m (Extension available in case of using modem)	RS-422/485: max 500m
Diagnosis function		Check available by LED and XG5000 diagnosis service	
Consumption current		120mA	120mA
Weight		56g	56g

#### Notes

Note 1) Max. 32 stations are available for consist the client and server. Station number setting range is 0~255

2.3 Name and Function of each part

XBM "S" Type			
No.	Name	Purpose	
①	Input indication LED	Input indication LED	
②	PADT connection connector	PADT connection connector	
③	Input connector and terminal block	Input connector and terminal block	
④	Output connector and terminal block	Output connector and terminal block	
⑤	Key switch	RUN / STOP key switch - In case key switch is STOP, remote mode change available	
⑥	Output indication LED	Output indication LED	
⑦	Status indication LED	Indicates operation status of CPU module - PWR(Red): Power status indication - RUN(Green): RUN status indication STOP mode: Off / RUN mode : On - Error(Red): Flicker in case error occurs	
⑧	8-1	Built-in RS-485 Connection connector	Built-in RS-485 connection connector - "+", "-" terminal connection connector of RS-485 communication
	8-2	Built-in RS-232C connection connector	Built-in RS-232C connection connector - "TD", "RD", "SG" terminal connection connector of RS-232C communication
	8-3	Power connector	DC24V power connector

XBC/XEC "E" type		
XBC-DR10E	XEC-DN10E	
XBC-DN10E	XEC-DN14E	
XBC-DP10E	XEC-DN20E	
XBC-DR14E	XEC-DN30E	
XBC-DN14E	XEC-DP10E	
XBC-DP14E	XEC-DP14E	
XBC-DR20E	XEC-DP20E	
XBC-DN20E	XEC-DP30E	
XBC-DP20E	XEC-DR10E	
XBC-DR30E		
No.	Name	Purpose
①	Input indication LED	Input indication LED
②	PADT connection connector	PADT connection RS-232C 1 channel connector
③	Input terminal block	Input connector and terminal block
④	Output terminal block	Output connector and terminal block
⑤	Key switch	RUN / STOP key switch -In case key switch is STOP, remote mode change available
⑥	Output indication LED	Output indication LED
⑦	Status indication LED	Indicates basic unit's operation status - PWR(Red) : power status indication - RUN(Green) : RUN status indication - STOP mode : Off / RUN mode : On - Error(Red): flicker in case error occurs
⑧	Built-in RS-232C/RS-485 Connection terminal block	Built-in RS-485 connection terminal block - "+", "-" terminal connection terminal block of RS-485 communication - "TD", "RD", "SG" terminal connection terminal block of RS-232C communication
⑨	Power terminal	AC100~240V power terminal block

**Notes**

Notes 1) XBC/XEC main units of "E" type are not able to use XGB expansion module.

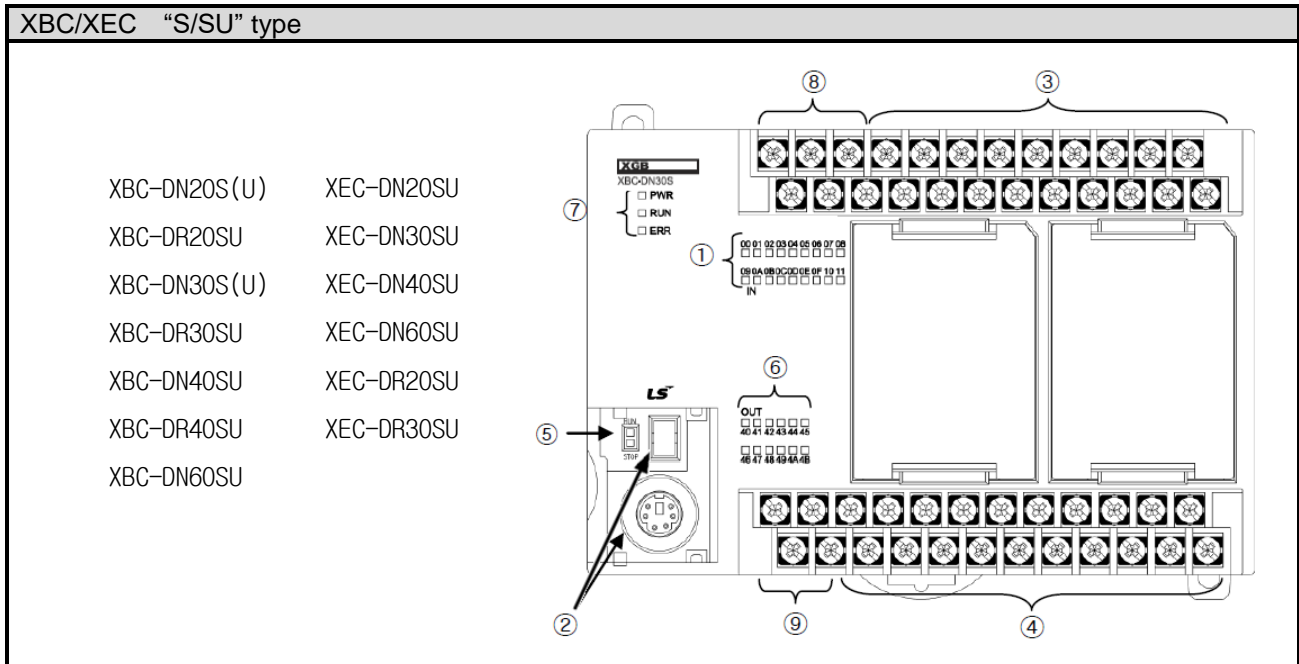

No.	Name	Purpose
①	Input indication LED	Input indication LED
②	PADT connection connector	PADT connection USB(USB 1.1 supported) 1 channel, RS-232C 1 channel connector <small>Notes 1)</small>
③	Input terminal block	Input connector and terminal block
④	Output terminal block	Output connector and terminal block
⑤	Key switch	RUN / STOP key switch -In case key switch is STOP, remote mode change available
⑥	Output indication LED	Output indication LED
⑦	Status indication LED	Indicates basic unit's operation status - PWR(Red) : power status indication - RUN(Green) : RUN status indication - STOP mode : Off / RUN mode : On - Error(Red): flicker in case error occurs
⑧	Built-in RS-232C/RS-485 Connection terminal block	Built-in RS-485 connection terminal block - "+", "-" terminal connection terminal block of RS-485 communication - "TD", "RD", "SG" terminal connection terminal block of RS-232C communication
⑨	Power terminal	AC100~240V power terminal block

**Notes**

Notes 1) The S-type of XBC/XBC doesn't provide an usb port.

XBC/XEC "H" type		
XBC-DR32H	XEC-DN32H	
XBC-DN32H	XEC-DN64H	
XBC-DR64H	XEC-DP32H	
XBC-DN64H	XEC-DP64H	
	XEC-DR32H	
	XEC-DR64H	
No.	Name	Purpose
①	Input indication LED	Input indication LED
②	PADT connection connector	PADT connection USB(USB 1.1 supported) 1 channel, RS-232C 1 channel connector
③	Input terminal block	Input connector and terminal block
④	Output terminal block	Output connector and terminal block
⑤	Key switch	RUN / STOP key switch -In case key switch is STOP, remote mode change available
⑥	Output indication LED	Output indication LED
⑦	Status indication LED	Indicates basic unit's operation status - PWR(Red) : power status indication - RUN(Green) : RUN status indication - STOP mode : Off / RUN mode : On - Error(Red): flicker in case error occurs
⑧	Built-in RS-232C/RS-485 Connection terminal block	Built-in RS-485 connection terminal block - "+", "-" terminal connection terminal block of RS-485 communication - "TD", "RD", "SG" terminal connection terminal block of RS-232C communication
⑨	Power terminal	AC100~240V power terminal block

Extension Cnet module		
No.	Name	Purpose
①	LED indication	Operation status indication
②	RS-422/RS-485 connector	Connector for connection with external device
③	RS-232C connector	Connector for connection with external device

LED name	LED indication content	LED status	LED status content
RUN	Operation status indication	On	Normal operation
		Off	Abnormal operation
I/F	Interface with main unit status indication	Flicker	Normal operation
		Off	Abnormal operation
TX	Indication during frame transmission	Flicker	Transmitting frame
		Off	Frame transmission completion
RX	Indication during frame receiving	Flicker	Receiving frame
		Off	Frame receive completion
ERR	Frame error indication	On	Frame error
		Off	Normal frame

[Table 2.3.1] LED indication content

## Chapter 3 System Configuration

XGB PLC is having diverse product suitable for main system, computer link and network system configuration. This chapter describes configuration method and characteristic.

### 3.1 XGB System Configuration

System configuration of XGB PLC is as follows. Extension I/O module, in case of special module, in “S” type, up to 7 step connection and in “H” type, up to 10 step connection is available. In communication module, up to 2 step extensions is available.

#### 3.1.1 “H” type system configuration

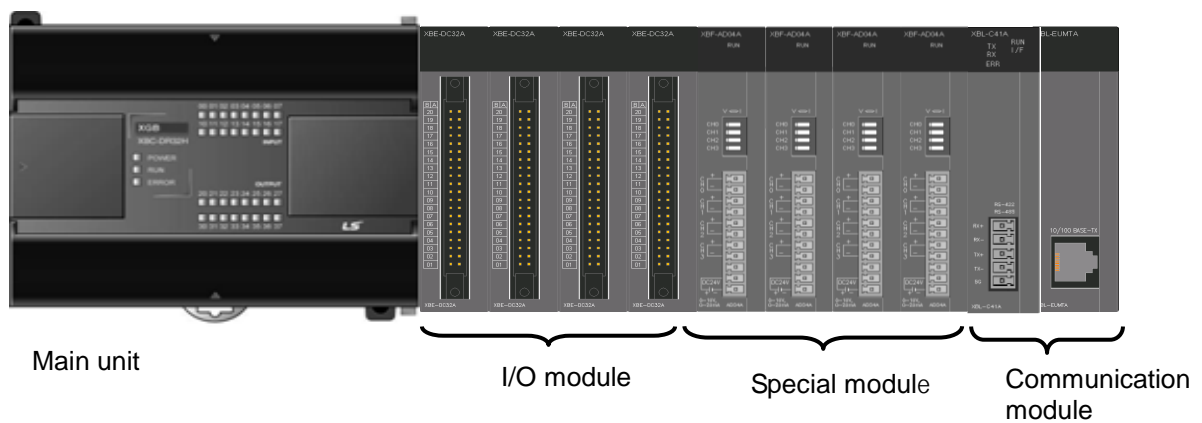

Item		content	
I/O configuration point		• XB(E)C-DxxxH: 32 ~ 384 points	
Extension module connection available no.	Digital I/O module	• Max. 10	
	Analog module	• Max. 10	
	Communication module	• Max. 2	
Product list	Main unit	“H” type	• XBC-DR32/64H      • XBC-DN32/64H • XEC-DR32/64H      • XEC-DN32/64H
	Extension module	Digital I/O module	• XBE-DC08/16/32 • XBE-TN08/16/32 • XBE-TP08/16/32 • XBE-RY08/16A • XBE-DR16A
		Analog module	• XBF-AD04A      • XBF-RD04A • XBF-DV04A      • XBF-RD01A • XBF-DC04A      • XBF-TC04S
		Communication module	• XBL-C41A      • XBL-C21A • XBL-EMTA
Option module	Memory module	• XBO-1024A	



### 3.1.2 “S” type System Configuration

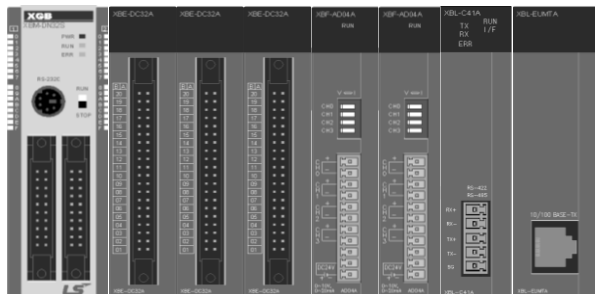

Main unit      I/O module      Special module      Communication module

Item		Content	
I/O configuration point		<ul style="list-style-type: none"> <li>• XBM-DxxxS : 16 ~ 352 point</li> </ul>	
Extension module connection available no.	Digital I/O module	<ul style="list-style-type: none"> <li>• Max. 7</li> </ul>	
	Analog module	<ul style="list-style-type: none"> <li>• Max. 7</li> </ul>	
	Communication module	<ul style="list-style-type: none"> <li>• Max. 2</li> </ul>	
Product list	Main unit	<ul style="list-style-type: none"> <li>• XBM-DR16S      • XBM-DN16/32S</li> </ul>	
	Extension module	Digital I/O module	<ul style="list-style-type: none"> <li>• XBE-DC08/16/32</li> <li>• XBE-TN08/16/32</li> <li>• XBE-TP08/16/32</li> <li>• XBE-RY08/16A</li> <li>• XBE-DR16A</li> </ul>
		Analog module	<ul style="list-style-type: none"> <li>• XBF-AD04A      • XBF-RD04A</li> <li>• XBF-DV04A      • XBF-RD01A</li> <li>• XBF-DC04A      • XBF-TC04S</li> </ul>
		Communication module	<ul style="list-style-type: none"> <li>• XBL-C41A      • XBL-C21A</li> <li>• XBL-EMTA</li> </ul>
	Option module	Memory module	<ul style="list-style-type: none"> <li>• XBO-1024A</li> </ul>

### 3.2 Available System Configuration

Communication system by using XGB built-in communication function and Cnet module is diverse. In this chapter, it describes system configuration example.

#### 3.2.1 1:1 Connection between PC (HMI) (No modem)

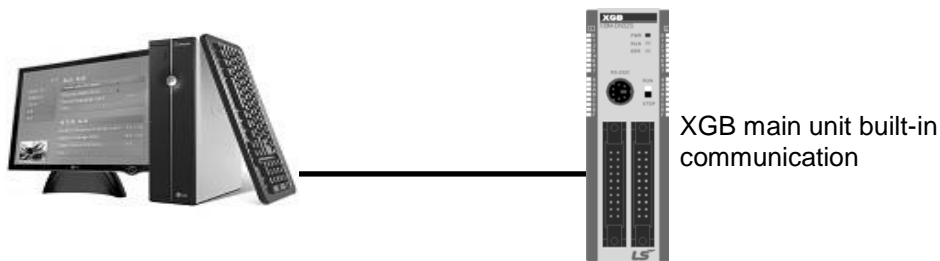

PC (HMI) and Cnet I/F module is connected by RS-232C or RS-422/485 channel, PC (HMI) and PLC is connected by 1:1 without modem. In most case, PC (HMI) acts as client and Cnet I/F module acts as server which respond request of PC (HMI). Since there is no modem, in case of using RS-232C channel, communication distance is max 15m, in case of using RS-422 channel, communication distance is max 500m. Operation mode of Cnet I/F module is set according to PC (HMI)'s communication method. Wiring method and system connection is applied in case of XGB "S" type built-in communication. In case of using XGB "H" type and external communication module, refer to 10.5 communication interface connection method.

(1) In case of using 1:1 connection with normal PC

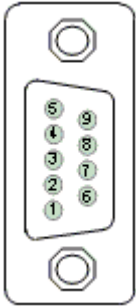
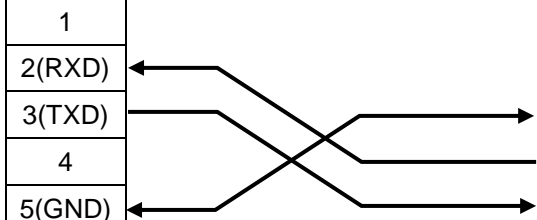

[Figure 3.2.1] 1:1 communication with PC

• Wiring method

External form of PC	PC	Connection number and signal direction	XGB main unit		XGB external form
	Pin no.		Pin no.	Signal name	
 <p>Female Type</p>	1		1	485-	
	2(RXD)		2	485+	
	3(TXD)		3	SG	
	4		4	TX	
	5(GND)		5	RX	
	6				
	7				
	8				
	9				

In case of using channel 2, connect 485+ and 485- of RS485 terminal.

(2) In case of using 1:1 connection with monitoring device such as XGT Panel

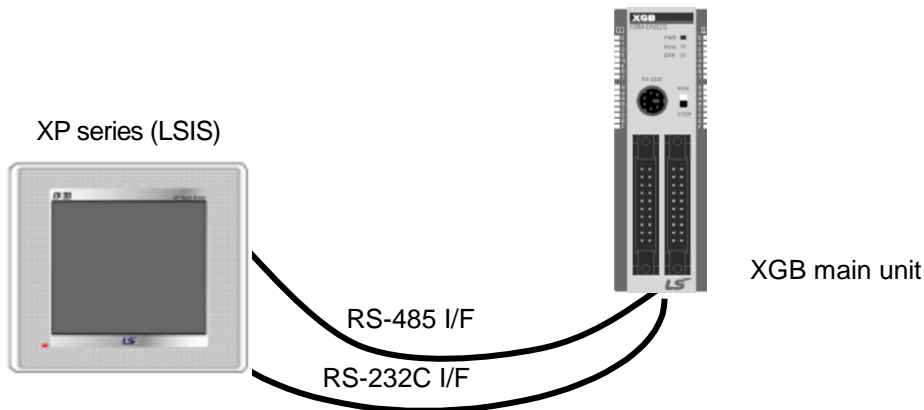

[Figure 3.2.2] 1:1 communication with HMI

• Wiring method (RS-232C)

XP external form	XP	Connection number and signal direction	XGB main unit		XGB external form
	Pin no.		Pin no.	Signal name	
<p>Female Type</p>	1		1	485-	
	2(RXD)		2	485+	
	3(TXD)		3	SG	
	4		4	TX	
	5(GND)		5	RX	
	6				
	7				
	8				
	9				

Note) In case of PMU, short no.4 and no.6, short no.7 and no.8.

• Wiring method (RS-485)

PMU	Connection no. and signal direction	XGB main unit
485+		485+
485-		485-

(3) In case of using 1:1 connection with XGB main unit

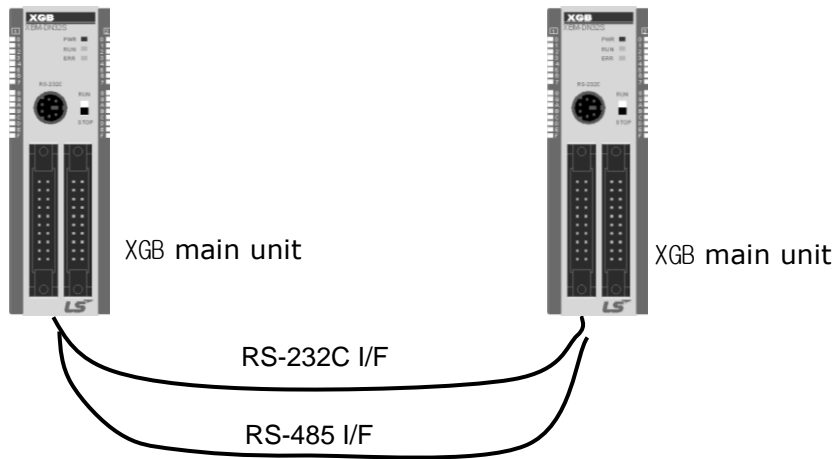

[Figure 3.2.3] 1:1 communication between PLCs

• Wiring method

XGB external form	XGB main unit	Connection no. and signal direction	XGB main unit	
	Pin no.		Pin no.	Signal name
	1	↔	1	485-
	2	↔	2	485+
	3	—	3	SG
	4	↔	4	TX
	5	↔	5	RX

**3.2.2 1:1 Dedicated modem connection with PC (HMI)**

It is 1:1 communication system connected through dedicated modem through RS-232C channel with PC (HMI). Normally, PC (HMI) acts as client station, Cnet I/F module acts as server station which respond request of PC (HMI). Since it uses modem, RS-232C channel should be set as dedicated modem and long distance communication is available. Operation mode of this module should be set according to communication method of PC (HMI).

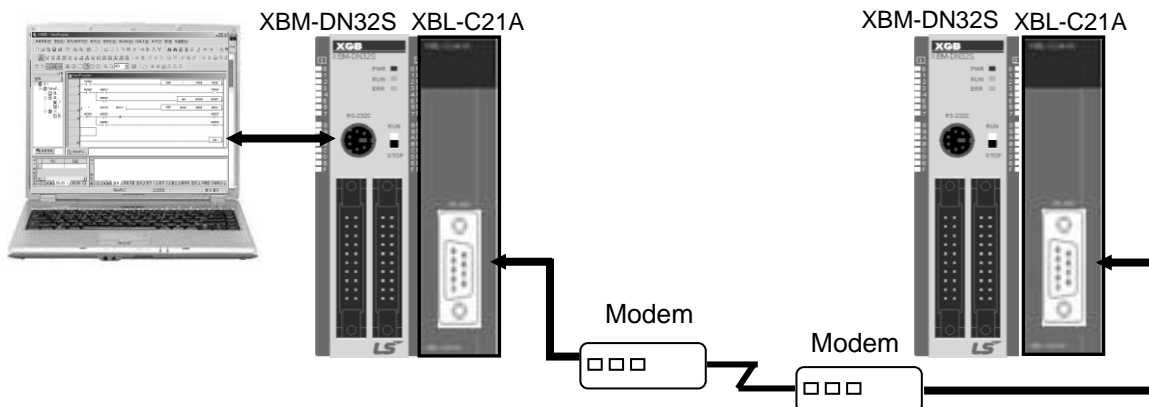

[Figure 3.2.4] dedicated modem communication with PC

**3.2.3 Modem connection with PC and communication between Cnet I/F modules**

- ◆ PC and Cnet #1 station is connected by modem through RS-232C channel
- ◆ Cnet #1 station ~ N station is communication between Cnet I/F module through RS-422 channel
- ◆ PC acts as client station of Cnet #1 station
- ◆ Up to max 32 station connection is available in case of Cnet I/F module (RS-422/485 communication)
- ◆ It sets station 1 among Cnet I/F module as server station
- ◆ Dedicate modem or dial-up modem available

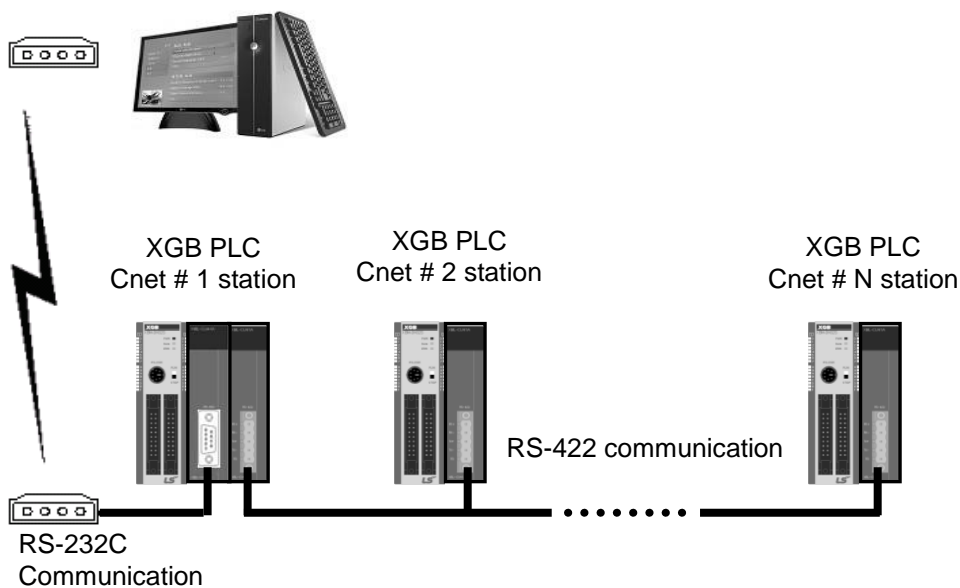

[Figure 3.2.5] Dedicated modem communication with PC

Type	Module setting	
	XBL-C41A	Station no.
PLC Cnet #1	P2P	1
	XGT client	
Cnet #2 ~ #N	XGT server	2~N

[Table 3.2.1] module setting table per station

3.2.4 Dedicated communication with PC (HMI) and different type RS-422 communication

- ◆ Null-modem communication by using PC (HMI) and RS-232C channel
- ◆ PC (HMI) acts as client station, Cnet I/F module acts as server, at this time, module setting acts as RS-232C XGT server
- ◆ Cnet I/F module RS-422 channel acts as P2P mode.
- ◆ It transmits indication data to display module of mosaic panel through RS-422 channel
- ◆ Reading display transmission data from PC

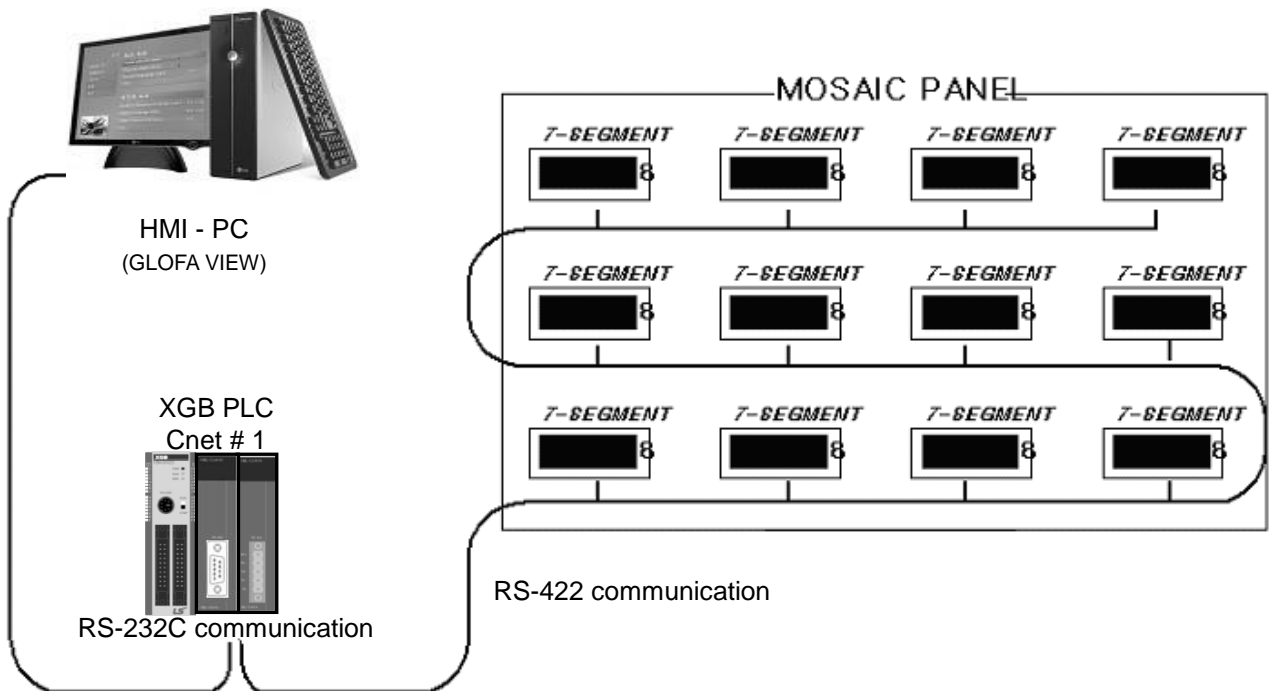

[Figure 3.2.6] 7-Segment operating system for RS-422

Type	Module setting		
	XBL-C21A	XBL-C41A	Station no.
PLC Cnet #1	XGT server	P2P	1

[Table 3.2.2] Module setting table per station

3.2.5 Optical modem communication for moving material communication

- ◆ Optical modem communication system for Cnet communication on material above moving linearly.
- ◆ P2P communication or dedicated mode communication with monitoring device
- ◆ RS-232C/RS-422 communication with optical modem
- ◆ Communication between Cnet I/F module is dedicated server/client communication
- ◆ Optical modem connected with Cnet I/F module on mobile body can communicate with the other optical modem only when positioned in communication available
- ◆ Main application: Parking tower

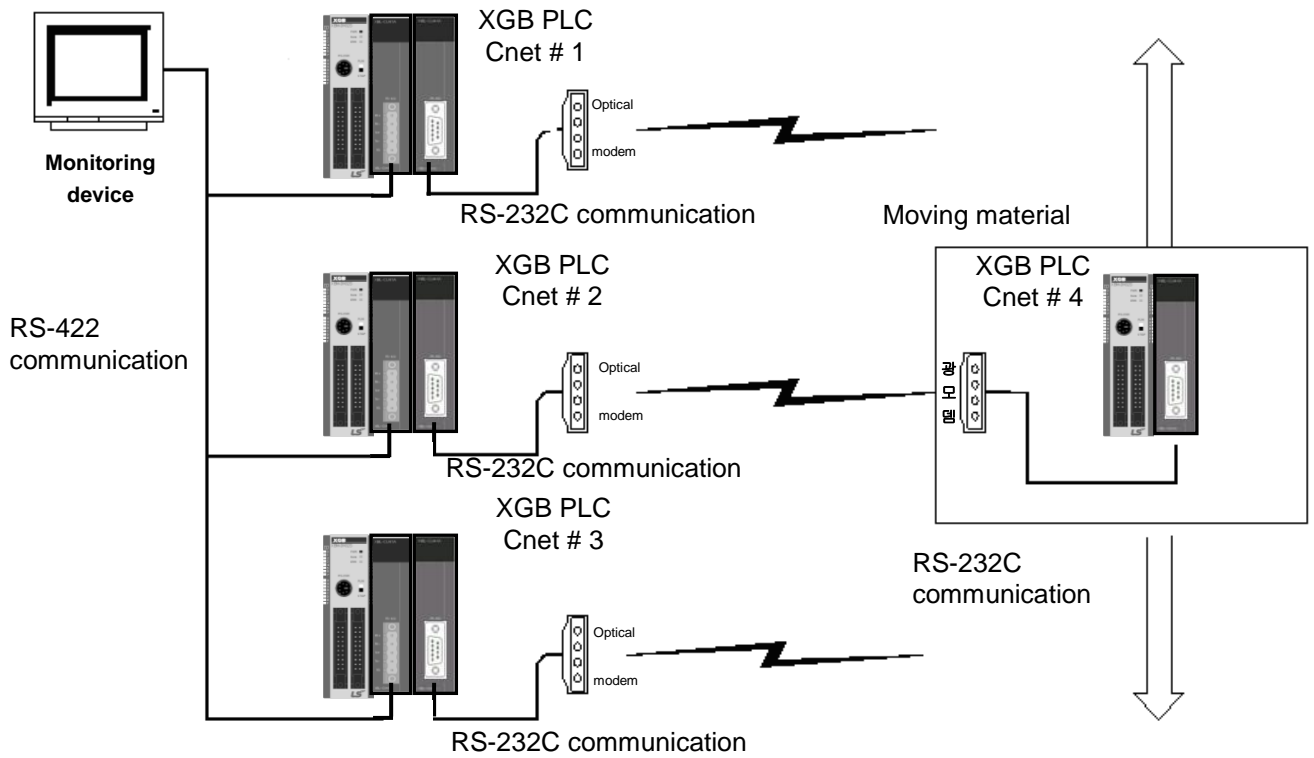

[Figure 3.2.7] Optical modem communication system

3.2.6 Wireless modem communication for communication between revolution bodies

- ◆ Wireless modem communication system for Cnet communication between revolution bodies
- ◆ RS-232C communication with wireless modem
- ◆ Communication between Cnet I/F module is dedicated/client communication
- ◆ RS-232C channel of Cnet I/F module is dedicated modem mode

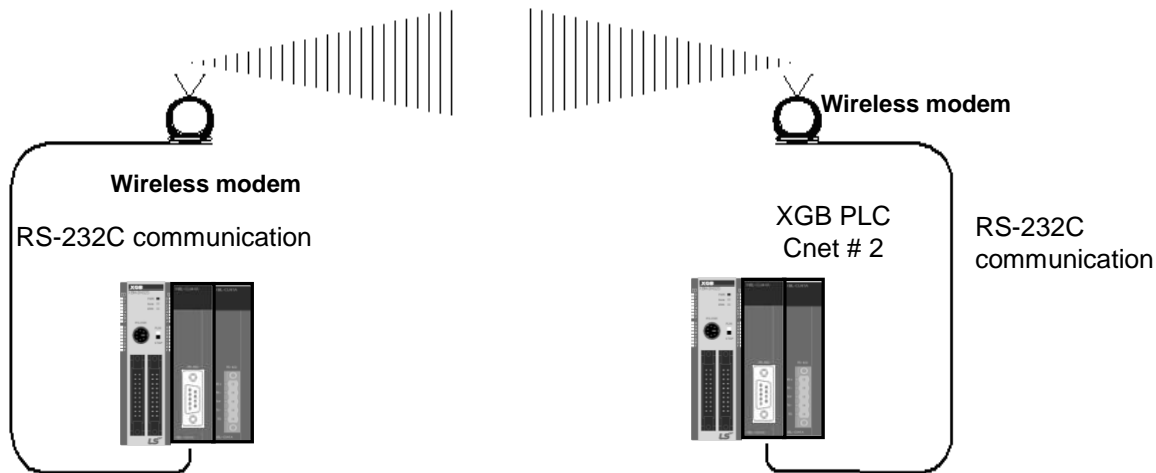

[Figure 3.2.8] wireless modem communication system

Type	Module setting		
	RS-232C	RS-422	Station
XBL-C21A	Dedicated mode	Not used	2 station
	User mode		

[Table 3.2.3] setting content table between communication module



## Chapter 4 Basic Setting

### 4.1 Setting Sequence of Product

It describes installation of product and sequence. Install system by be operated by the following sequence.

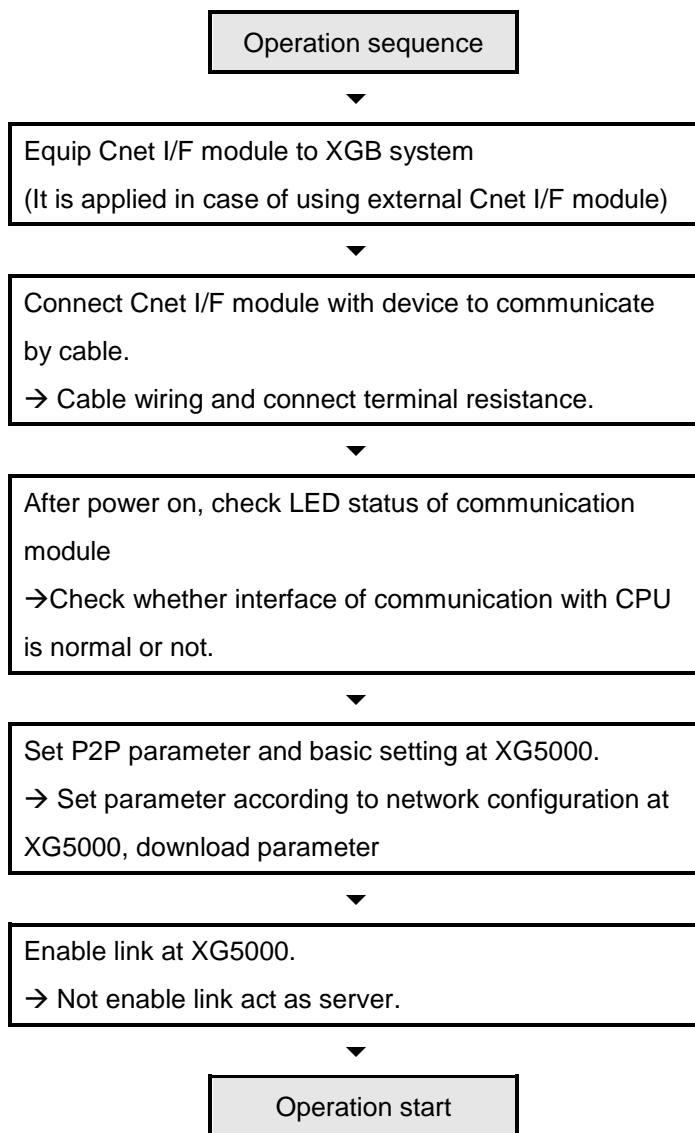

**Note**

1) In Cnet I/F module, hardware station setting is not necessary.  
By using XG5000, designate station and basic setting necessary in Cnet communication.

## 4.2 PLC Type Setting and How to Register Communication Module

To use Cnet I/F function, communication parameter should be written by XG5000. To set system about Cnet I/F module located in temporary position, register each module at XG5000. Method on register Cnet I/F module is as follows according to On/Off line status.

### 4.2.1 Making new project

First, after click Project-New Project and input project name, select XGB series as PLC series. (In case of IEC type, select XGB(IEC)) About CPU type, in case of “S” type, select “XGB-XBMS”, in case of “H” type, select “XBC-XBCH”.

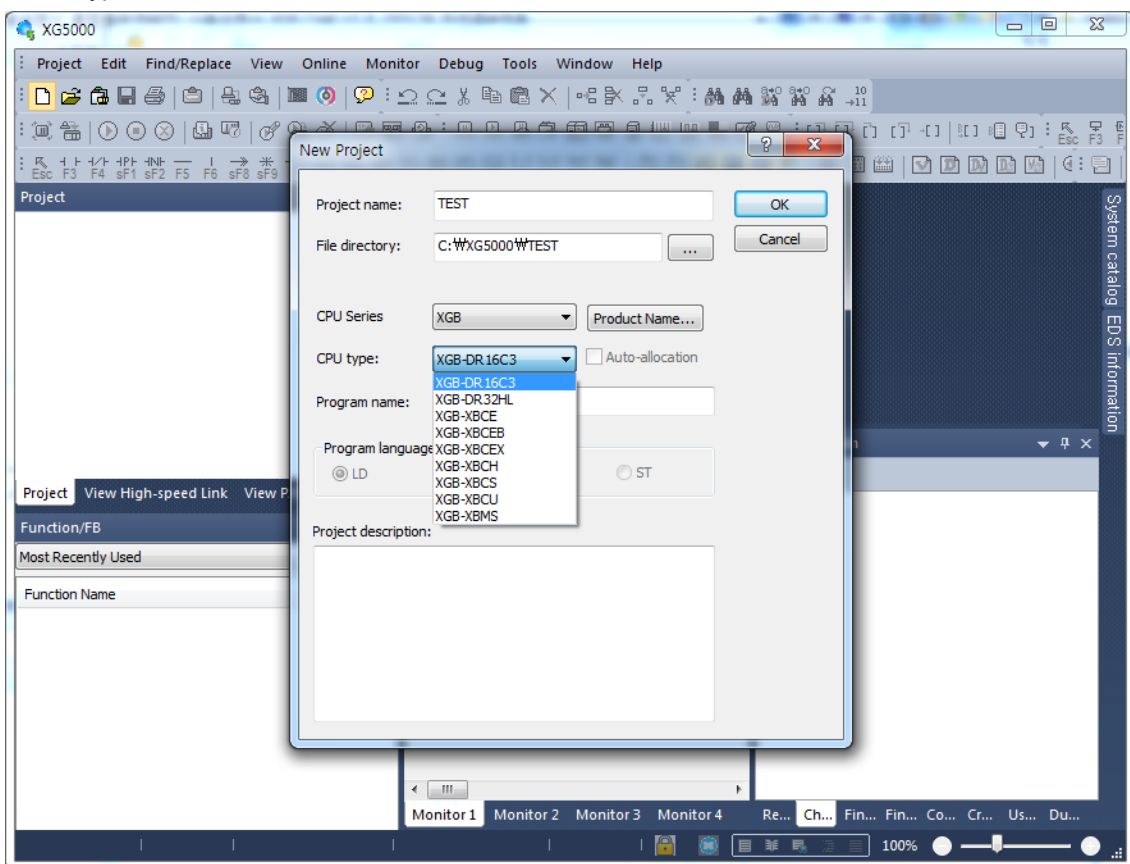

[Figure 4.2.1] New project making screen

**4.2.2 In case of off line, method on Cnet I/F module registration**

In the status PLC is not connected, in case the user set about communication module and write parameter related with communication, right click “Unspecified Network” in the project tree and select [Add Item]-[Communication Module]. Click “Add Module” in the “Select communication module” window. Then register the Cnet I/F module about wanted slot position in the “Communication Module Settings” window.

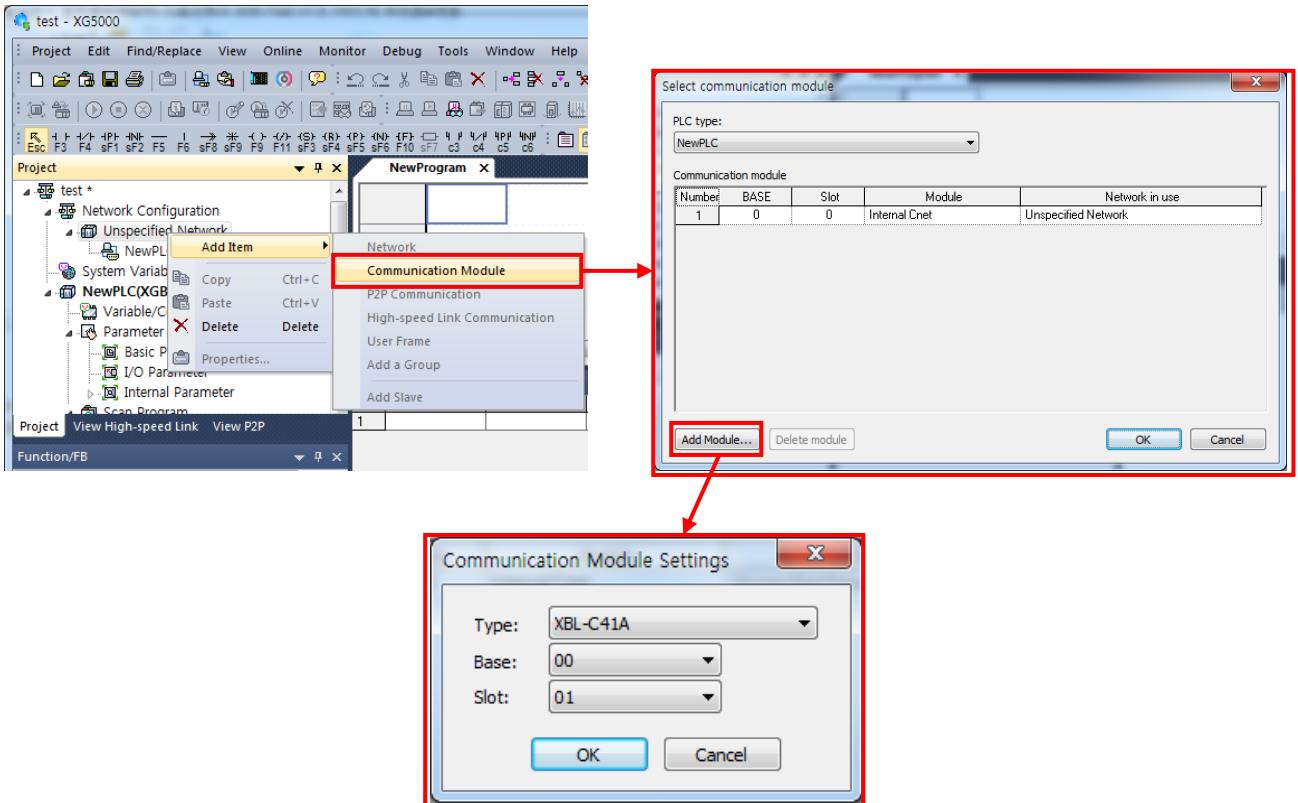

[Figure 4.2.2] Cnet module registration screen

**4.2.3 How to register Cnet I/F module in case of online**

If you register communication module at online status by using XG5000, you should connect basic unit. After [Online]-> [Connection] after doing communication setting by using [Online] -> [Connection Settings] and doing local connection (or remote 1/2 connection). In case of normal connection, lower menu of “online” is activated, selecting [Online]-> [Diagnosis]-> [I/O Information] and click “I/O Sync”, then equipped communication module is searched automatically.

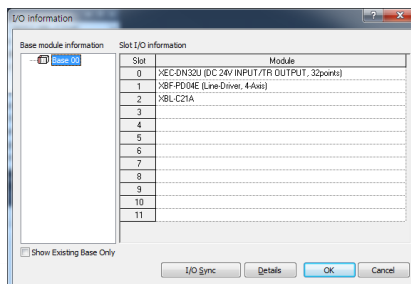

[Figure 4.2.3] Cnet I/O information screen

At this time, the following message occurs. Check the message and click “Yes” or “No”.

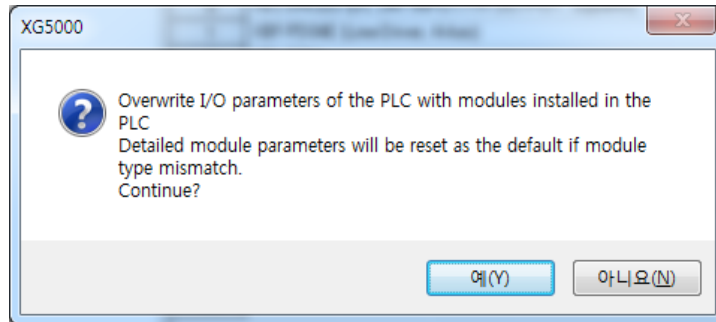

[Figure 4.2.4] I/O information change message

If you execute Read IO Information, equipped communication module like the following is indicated IO module information window.

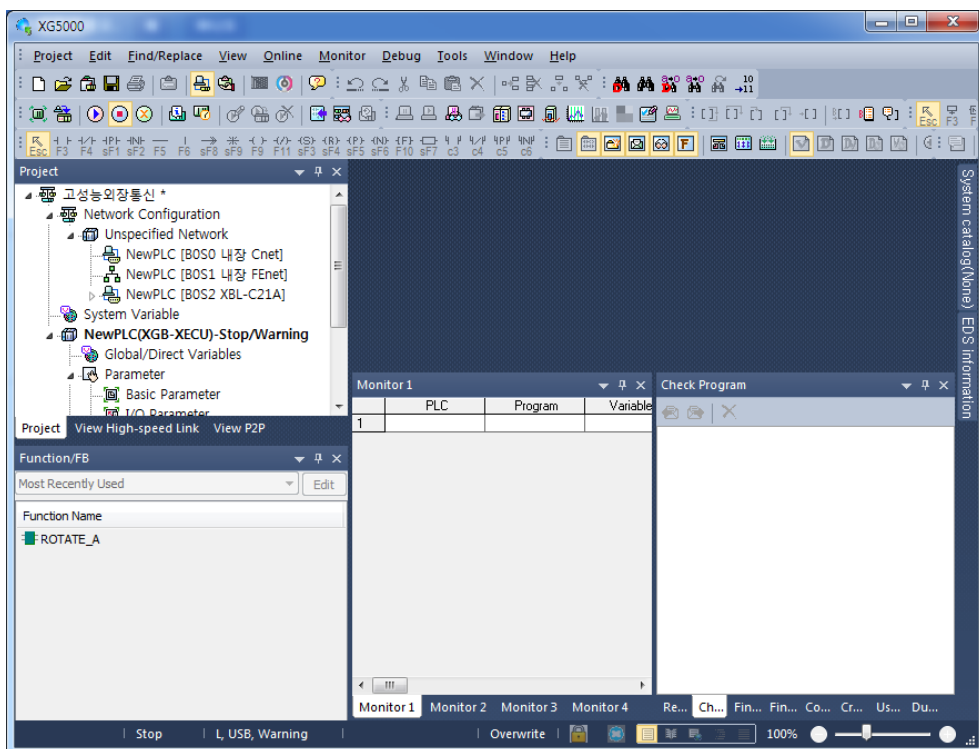

[Figure 4.2.5] Communication module registration compete screen

### 4.2.4 Read parameter saved in PLC

For read the basic setting of communication module and P2P setting that saved in PLC, select [Project]-[Open from PLC] then set the connection settings and click “OK”.

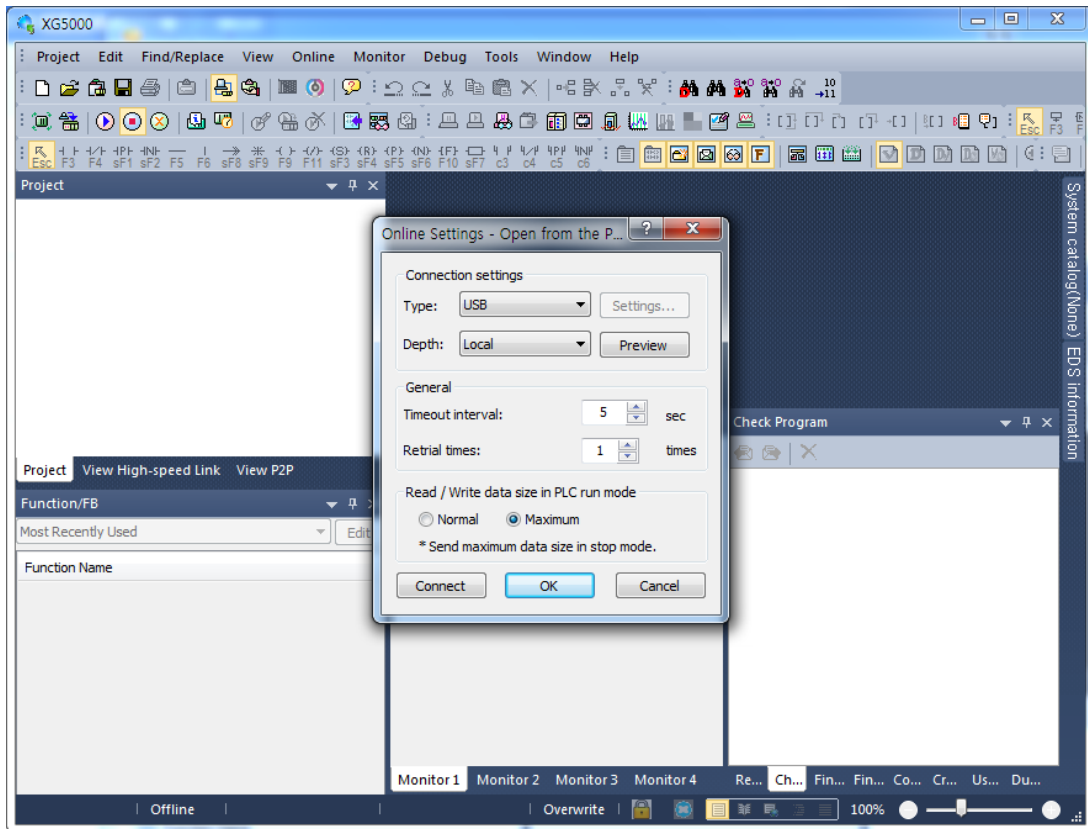

[Figure 4.2.6] Open form PLC

### 4.3 How to Set Basic Parameter

Communication function used in Cnet I/F module is classified as followings.

#### 1) Server mode service

- Without other program at PLC, you can read or write information in PLC and data.
- It can act as XGT server providing XGT dedicated protocol and Modbus server providing RTU/ASCII protocol.

#### 2) Client (P2P) service

- Cnet I/F module acts as client in network.
- In case designated event occurs, you can read or write memory of other station.
- It can act as XGT client and Modbus client.
- In case of sending/receiving user wanted frame and communicating with other device.
- You can define P2P block with max. 32 per one channel acting independently.

#### 3) Loader service

- By using remote 1/2, you can monitor/download program about remote PLC.

To use Cnet I/F module, you should set transmission specification such as data type like transmission speed and data/stop bit.

You should select transmission specification of system to be same with specification of system.

Written standard setting value is saved CPU module of PLC and this value keeps though power goes off and this value is not changed before writing. Also though Cnet I/F module is changed and new module is installed, the standard setting value saved at CPU module previously written is applied to new module automatically. Standard communication setting parameter and P2P, all parameter is applied if download is complete.

### 4.3.1 Setting item

When setting Cnet communication parameter, the fact the user should define is as follows [Table 4.3.1]

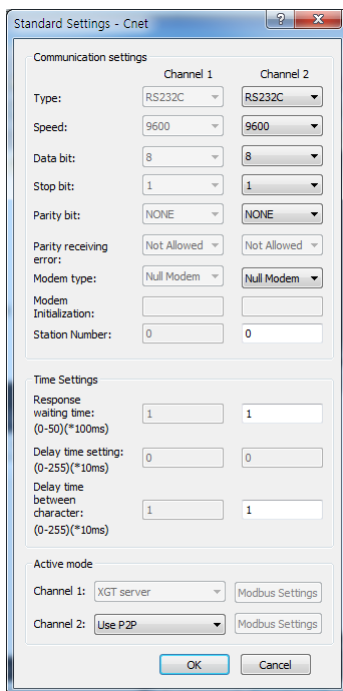

[Figure 4.3.1] Built-in communication standard setting screen

Item	Setting content
Station no.	• You can set from station 0 to station 255.
Communication speed	• 1200, 2400, 4800, 9600, 19200, 38400, 57600, 115200 bps available
Data bit	• 7 or 8 bit available
Parity bit	• None, Even, Odd available
Stop bit	• 1 or 2 bit available
Communication channel	<ul style="list-style-type: none"> <li>• It is fixed as follows according to Cnet type</li> <li>1) Built-in communication → channel 1 : RS-232C , channel 2 : RS-485</li> <li>2) XBL-C41A → channel 1 : not used, channel 2: RS-422/RS-485</li> <li>3) XBL-C21A → channel 1 : not used, channel 2: RS-232C</li> </ul>
Response waiting time	<ul style="list-style-type: none"> <li>• It sets the time waiting respond after sending frame</li> <li>1) Setting: It can be set when active mode is "Use P2P".</li> <li>2) Waiting time: 100ms+(value X 100ms)</li> </ul>
Delay time	<ul style="list-style-type: none"> <li>• It sets interval of communication frame</li> <li>1) Setting: It can be set when communication channel is RS-422/485.</li> </ul>
Delay time between character	<ul style="list-style-type: none"> <li>• If receives the character while in set time, it process as one frame.</li> <li>1) Setting: It can be set regardless of setting</li> <li>2) If set delay time "0", 3.5 character time<sup>Note 1)</sup> will apply that fits communication speed.</li> </ul>

[Table 4.3.1] communication parameter setting item

The meaning of each item is as follows.

1) Parity bit

Cnet I/F module can define three parity bits. Meaning of each parity bit is as follows.

Parity bit type	Meaning	Reference
None	Not using parity bit	
Even	If the number of 1 in one byte is even, parity bit becomes "0".	
Odd	If the number of 1 in one byte is odd, parity bit becomes "1".	

[Table 4.3.2] Parity content table

2) Operation mode setting

- Sets operation mode

Driver type	Meaning	Reference
P2P	Each port acts as client and executes the communication by setting P2P parameter.	P2P setting reference
XGT server	It acts as XGT server supporting XGT dedicated communication.	Dedicated service
Modbus ASCII server	It acts as Modbus ASCII server	Modbus communication
Modbus RTU server	It acts as Modbus RTU server	Modbus communication

[Table 4.3.3] operation mode setting item

**Note**

Note 1) Character Time: The time of sending one character. This value can be changed according to communication speed

In case of communication speed is 9600bps

Character Time=(Bit number of one character(11)/Communication speed)\*Character time

$$=(11/9600)*3.5$$

$$=4.01\text{ms}$$



### 4.3.2 Setting method

You should do like following to operate Cnet I/F module according to communication specification defined by user. In case of setting like the followings about XBL-C41A (RS-422/485 1 port) installed slot 2, setting method is as follows.

(1) Communication specification

- Channel 2: RS-422, 38400Bps, 8/1/Odd, Null modem, P2P, 2 station, delay time 10 ms

Executing XG5000, you register communication module Cnet for setting at each slot position. After Cnet module is registered, if you double-click Cnet module, the following standard setting window shows.

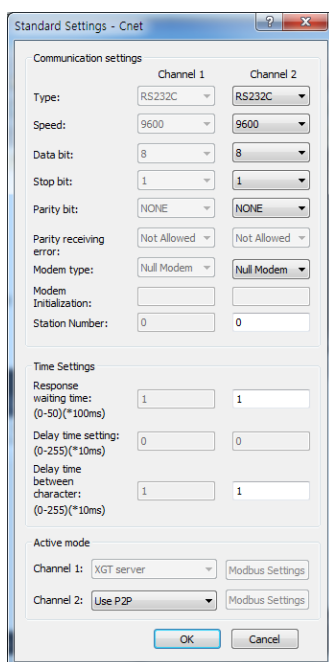

[Figure 4.3.2] Communication module setting screen

If standard communication parameter setting ends, download Cnet module.

If you select [Online -> Write], download is executed. After downloading, parameter is applied shortly.

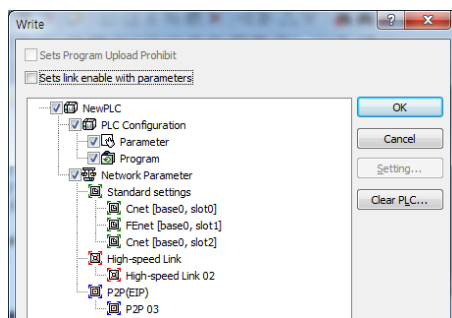

[Figure 4.3.3] Write Parameter screen

## Chapter 5 Remote Connection

### 5.1 Remote Connection

#### 5.1.1 General

In case PC executing XG5000 is far from XGB PLC, if you use remote connection function of Cnet I/F module, you can control remote PLC such as program download, upload, program debugging and monitor. Especially, in case XG5000 is far from PLC, if you use XG5000 remote connection function and modem connection function of Cnet I/F module, you can access easily by remote connection through air line. Remote connection is supported at XGB communication module, FEnet I/F module and Cnet I/F module. Connection between networks is available and you can control remote PLC through multiple connections. There are two methods for remote connection by using Cnet I/F module, first, XG5000 is connected with Cnet I/F module of remote PLC through modem, second, XG5000 and local PLC are connected into CPU through RS-232C, Cnet I/F module of local PLC communicates with Cent I/F module of remote PLC.

#### 5.1.2 XG5000 remote connection

[Figure 5.1.1] is figure indicating remote connection example where XG5000 and PLC are connected through modem. Like figure, it is necessary configuration in case PC executing XG5000 is far from PLC and telephone line and connected by dedicated modem or wireless modem. At this case, you should connect Cnet I/F module by modem from XG5000 and you should select modem as connection method at connection option. There are two methods, dedicated modem connection using dedicated line and dial-up modem connection using public line.

##### (1) Dial-up modem connection

[Figure 5.1.1] is example using dial-up modem. You can establish remote connection by connecting dial-up modem to PC and Cnet I/F module (RS-232C). In PC side, you can use external modem or internal dial-up modem and in Cnet I/F side (RS-232C), you should use external modem.

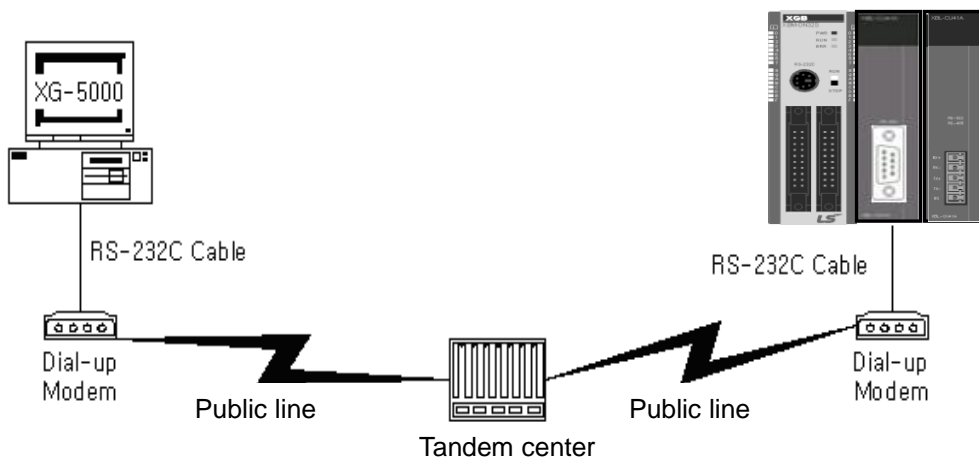

[Figure 5.1.1] XG5000 remote connection example by dial-up modem

Remote connection sequence by using dial-up modem is as follows.

(a) Cnet I/F module connected with PLC setting

- 1) Sets active mode of RS-232C channel of Cnet I/F as XGT server at XG5000.
- 2) Sets Modem type of Cnet I/F module (RS-232C) as Dial-up modem and inputs atz in Modem Initialization.

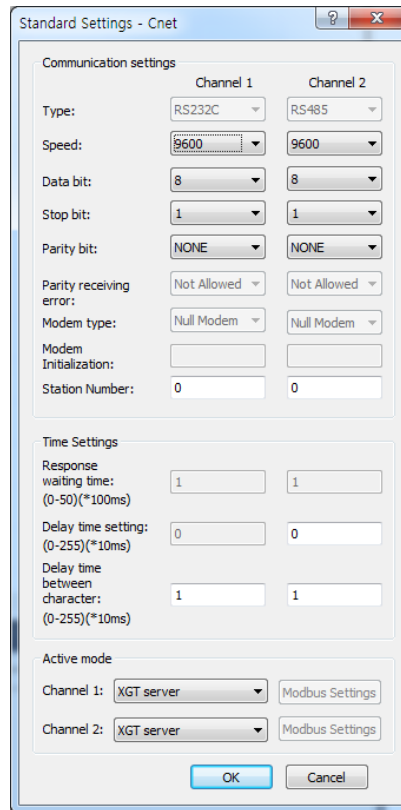

[Figure 5.1.2] XG5000 setting example

(b) XG5000 setting

- 1) Execute XG5000 and pop up online settings window by selecting “Online -> Connection settings”.

Here selects “Connection settings -> Type” as Modem.

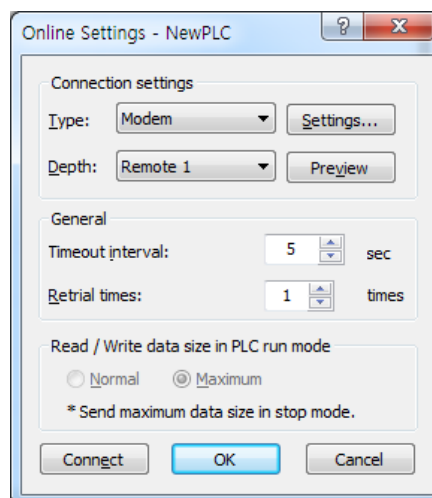

[Figure 5.1.3] Modem connection setting screen of XG5000

- 2) Select settings of “Connection settings” and set detail of modem

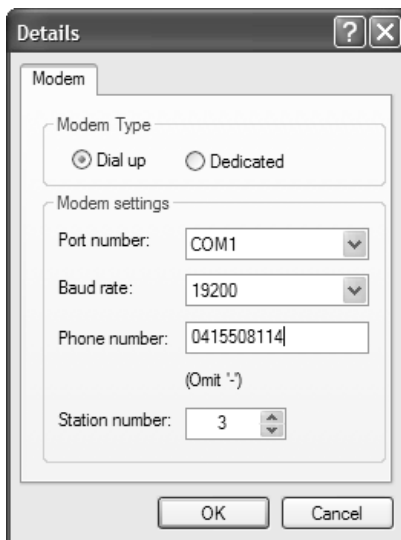

[Figure 5.1.4] Modem detail setting screen

### Note

Baud rate in modem settings means communication speed between PC and modem, not communication speed of modem. Baud rate of modem means communication speed between modem and modem, it is set automatically according to quality of public line and destination modem's speed.

For XG5000 remote connection at XGB PLC, you should use RS-232C channel. At communication standard setting, set “RS-232C dial-up modem” and write it to XGB Cnet I/F module.

- 3) Phone number means phone number of modem side connected with Cnet I/F module, in case of going out from local through extension line, you can use extension number and ‘,’ symbol.

(Ex) In case extension number is ‘9’: set as 9, 0343-398-xxxx

### Note

In case modem connected with Cnet I/F module of destination station is through tandem center, communication is impossible. Namely, there is extension number for receive station, dial-up modem communication is impossible.

- 4) In case of selecting connection step as remote 2, like the following, select base and slot number of remote 1 communication module in detail and communication module station number of remote 2. Inputs station number set in Cnet I/F module, In case of Cnet channel, selects communication channel of remote 2.

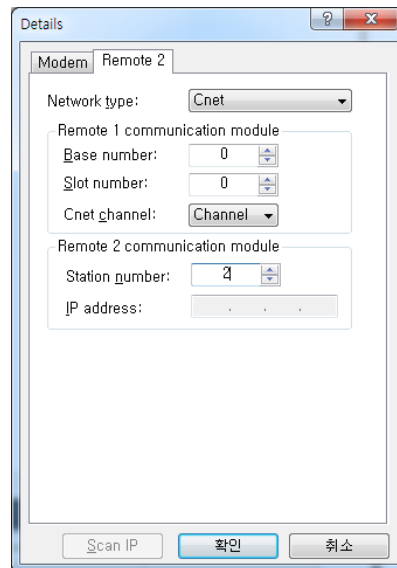
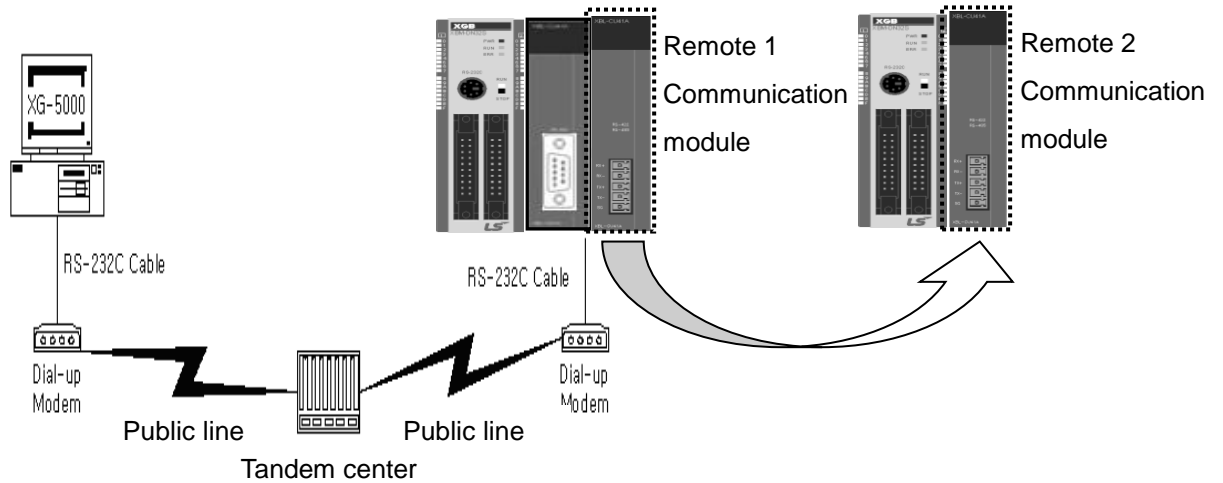

[Figure 5.1.5] Modem remote 2 setting screen

- 5) Select connection on online after setting connection option, modem initialization dialog box shows and modem is initialized.

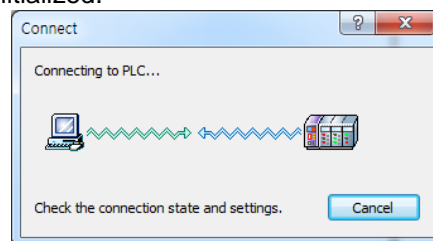

[Figure 5.1.6] Connecting to PLC

- 6) In case setting of COM channel of modem or connection with modem is wrong or, the error message shows. At this time, check COM channel or modem connection.

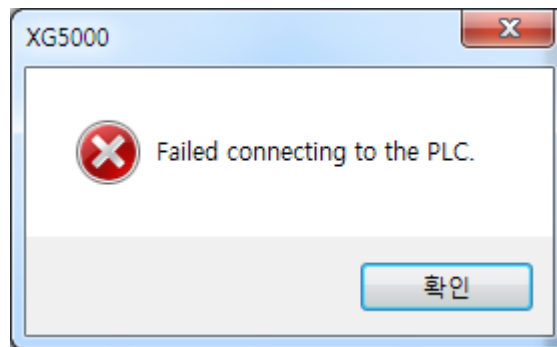

[Figure 5.1.7] Failed connecting

- 7) If making phone call is complete, XG5000 tries remote connection. In case remote connection is complete, "Online" menu is activated.
- 8) This case is same with connection status where connection is established through RS-232C cable. Here you can use all function of online menu.
- 9) In case you want to disconnect remote connection, select disconnect at online menu. Then disconnection menu box shows and remote connection is disconnected.
- 10) If connection is disconnected, XG5000 quit call automatically and disconnection telephone connection.
- 11) If it is success to quit call normally, local and remote modems return to initialization status. You can establish remote connection through making phone call.

### Note

After remote connection, you can use online menu of XG5000 like local connection. You can use program download/upload/monitor function etc. PLC control through modem is affected by capability of modem and status of telephone line. In case telephone line is bad, connection may be canceled. At this time, don't try reconnection instantly, wait for 30s and retry again from step 1)

### (2) Dedicated modem connection

The following figure indicates that PC and Cent module is connected by dedicated modem through dedicated line.

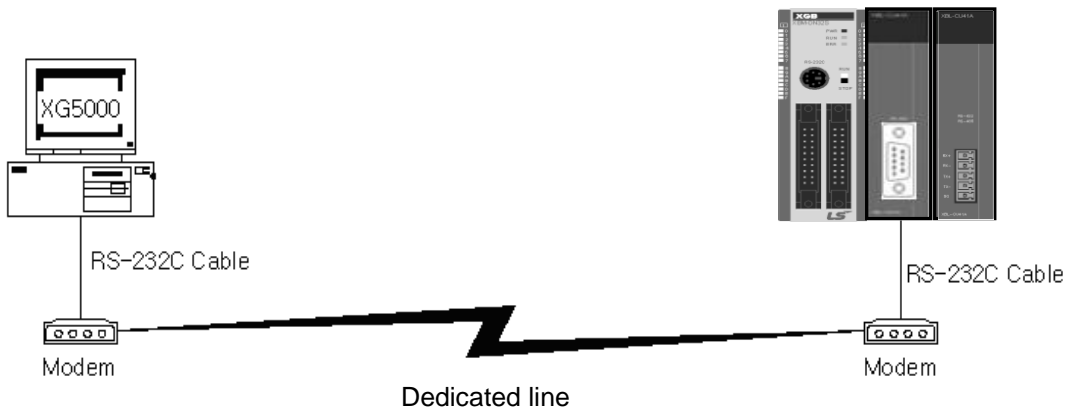

[Figure 5.1.8] XG5000 remote connection example by dedicated modem

[Figure 5.1.8] is example of dedicated modem connection by dedicated line. You can use wireless modem, optical modem other than dedicated modem. For setting method of modem not using public line, it is same with case of dedicated modem and refer to the followings.

Remote connection sequence by dedicated modem is as follows.

- (a) Connects PC with dedicated modem at Cnet I/F module
- (b) Cnet I/F module setting connected at remote PLC
  - 1) Sets RS-232C channel of Cnet I/F module as XGT server.
  - 2) Sets RS-232C channel operation of Cnet I/F module as dedicated modem .
- (c) XG5000 setting
  - 1) Execute XG5000 and select “Online -> connection settings” and pop up online settings window. Here set “Connection settings -> Type” as Modem. Press the “Settings” button and set communication channel and baud rate set in dedicated modem connected with PC. Baud rate should be same with communication speed of dedicated modem.

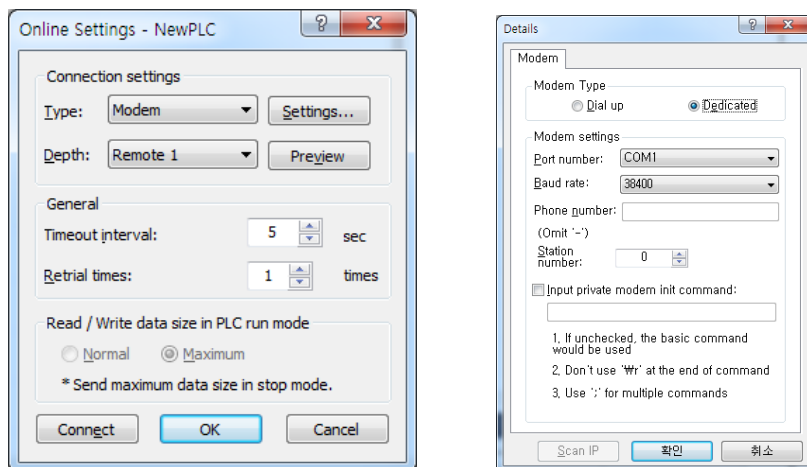

[Figure 5.1.9] dedicated modem setting screen

2) In case of setting depth as remote 2, set settings related with remote 1, 2 at the “Detail” window like the followings.

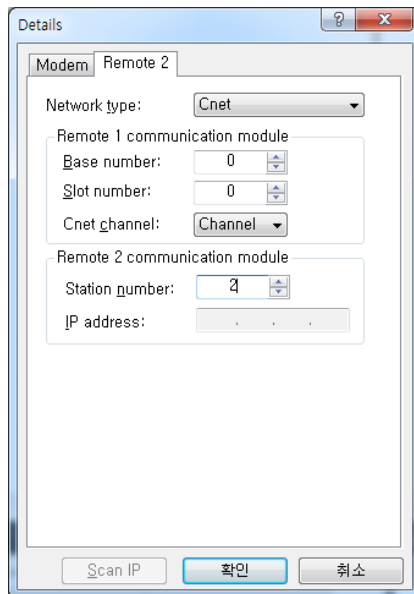

[Figure 5.1.10] dedicated modem remote 2 setting screen

- 3) After completing setting, if you click connection of connection setting, XG5000 tried remote connection. In case remote connection is complete, it is same when connection is established by RS-232C cable. Here you can use all functions of “Online” menu.
- 4) In case you want to disconnect remote connection, select disconnect at online menu. Disconnection menu box shows and remote connection is disconnected.
- 5) If disconnection is done normally, Cnet I/F module and XG5000 are switch into initial mode. In case of reconnection, retry from 2) item to reconnect.
- 6) Since for optical modem, wireless modem, only media between modems is different. Connection method is same.

### Note

After remote connection, you can use online menu of XG5000 like local connection. You can use program download/upload/monitor etc. PLC control through modem is affected by capability of modem and status of telephone line. In case telephone line is bad, connection may be canceled. At this time, don't try reconnection instantly, wait for 30s and retry again from step 1)



### 5.1.3 Remote connection between Cnet I/F modules

(1) Remote connection through dedicated modem

[Figure 5.1.11] indicates that XG5000 and local PLC is connected through RS-232C cable and in case RS-232C channel of Cnet I/F module equipped at local PLC communicates with Cnet I/F module of remote PLC through dedicated modem. Figure is example indicating remote connection with remote PLC. Like figure, XG5000 uses modem communication function between Cnet I/F modules and control remote PLC by using remote connection.

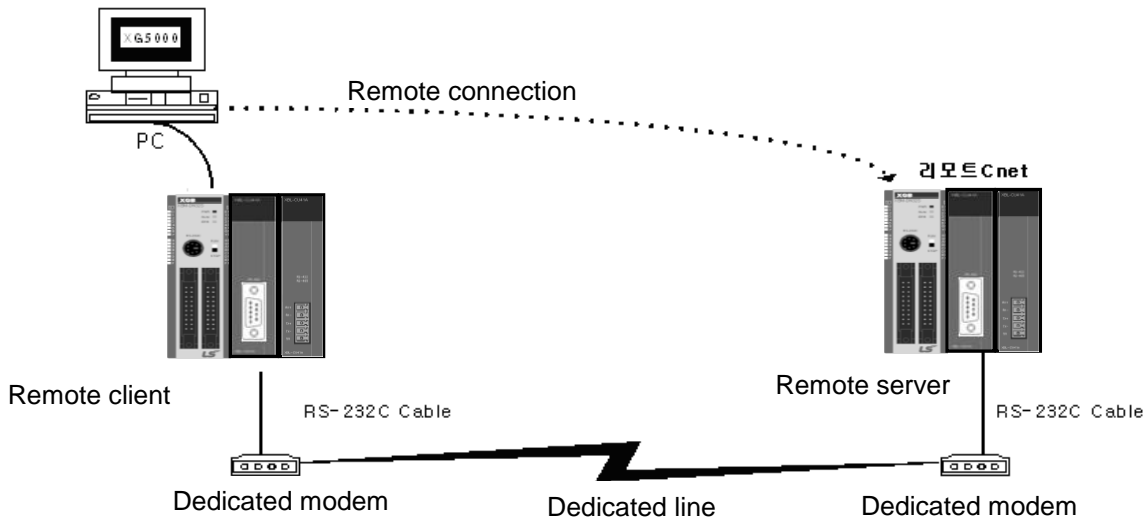

[Figure 5.1.11] remote connection between Cnet I/F modules

Remote connection sequence by dedicated modem is as follows.

(a) Cnet I/F module setting connected at remote PLC

- 1) Set RS-232C channel operation of Cnet I/F module at XG5000 as dedicated modem and have it operate as XGT server.

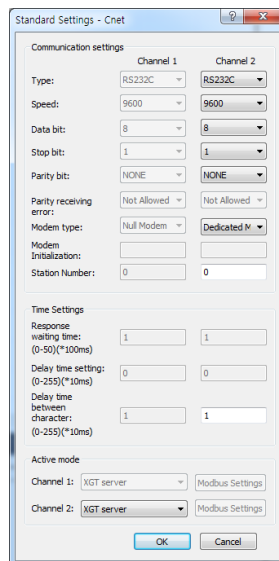

[Figure 5.1.12] Cnet I/F module XG5000 setting of remote PLC

(b) Cnet I/F module setting connected at local PLC

1) Converts local connected PLC to Stop mode

**Note**

Basic parameter of remote server connected through XG5000 should be set as server. In case of remote client, it should be set as P2P client.

In case there are many communications, if you try to remote connection, you may fail. Be sure to convert local PLC to stop mode and stop communication before remote connection.

(c) XG5000 setting

1) Set active mode of RS-232C of Cnet I/F module at XG5000 as Use P2P settings.

2) Set modem type of Cnet I/F module (RS-232C) as dedicated modem.

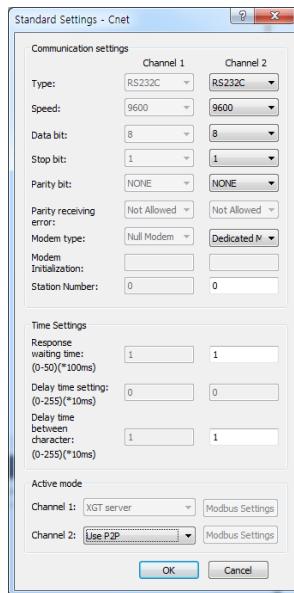

[Figure 5.1.13] Cnet I/F module XG5000 setting of local PLC

3) XG5000

a) Execute XG5000 and select “Online – Connection Settings” and set connection method.

Select Type as RS-232C and communication channel. This is same in case of local connection.

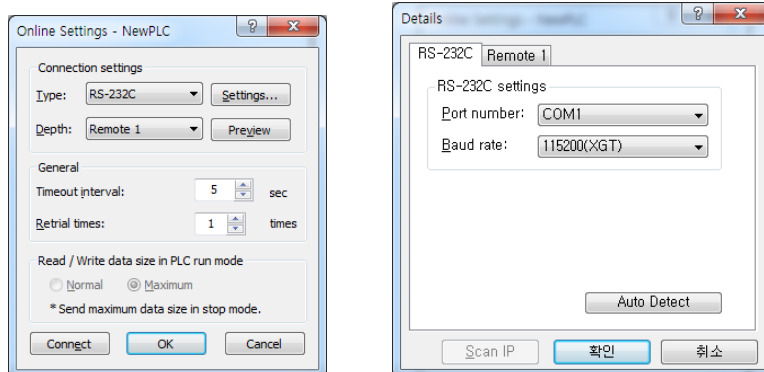

[Figure 5.1.14] XG5000 remote connection setting screen

- b) Select depth as remote 1 and click “Settings” for detail setting. In the detail window, set station number. AS for station number, input station number set in Cnet I/F module to execute remote connection. Figure is case Cnet station number is set as 1.

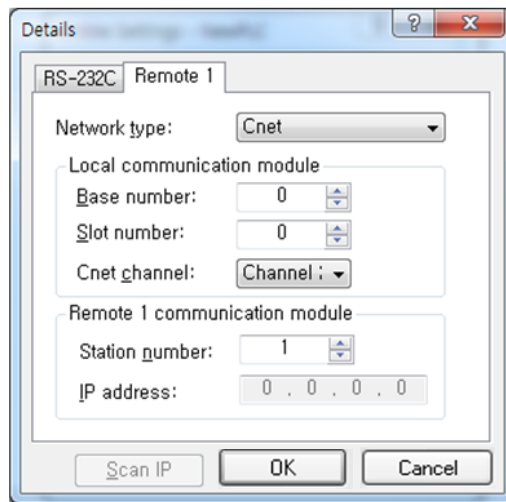

[Figure 5.1.15] XG5000 remote 1 connection setting screen

- c) XG5000 tries remote connection and in case remote connection is complete, online related function is activated.
- d) In this case, remote 1 connection is complete, it is same status with where it is connected by RS-232C cable. Here you can use all functions of online menu.
- e) In case you want to disconnect remote connection, select disconnect at online menu. Disconnection menu box shows and remote connection is disconnected. In case disconnection is done normally, Cnet I/F module and XG5000 are converted into initial mode. In case of reconnection, retry from (a) for reconnection.
- f) In case of optical modem, wireless modem other than dedicated modem, communication media is only different, method of remote connection is same.
- g) [Figure 5.1.16] indicates remote connection by wireless modem. As for connection method, it is same with method of remote connection between Cnet I/F module by using communication. In case of using wireless modem, 1:N remote connection where there are many Cnet I/F module is also available.

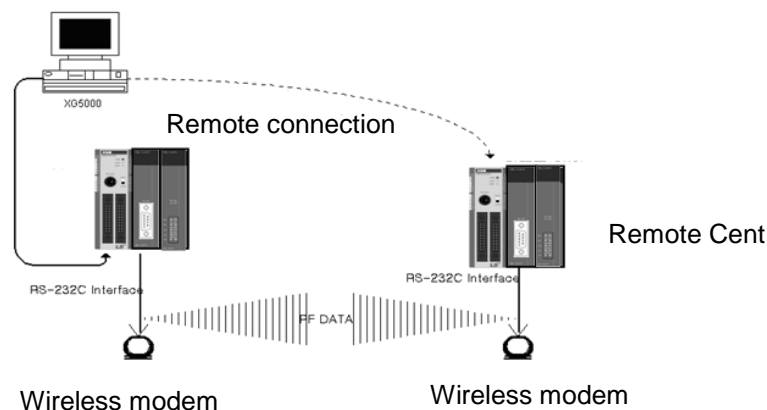

[Figure 5.1.16] remote connection by using wireless modem

### (2) Remote connection by RS-422/485

[Figure 5.1.17] indicates XG5000 and local PLC is connected into CPU module by RS-232C cable, in case RS-422/485 channel of Cnet I/F module connected at local PLC communicates, it is figure indicating remote connection example to remote PLC. Like figure, XG5000 can control program of remote PLC by remote connection through remote connection function between Cnet I/F modules.

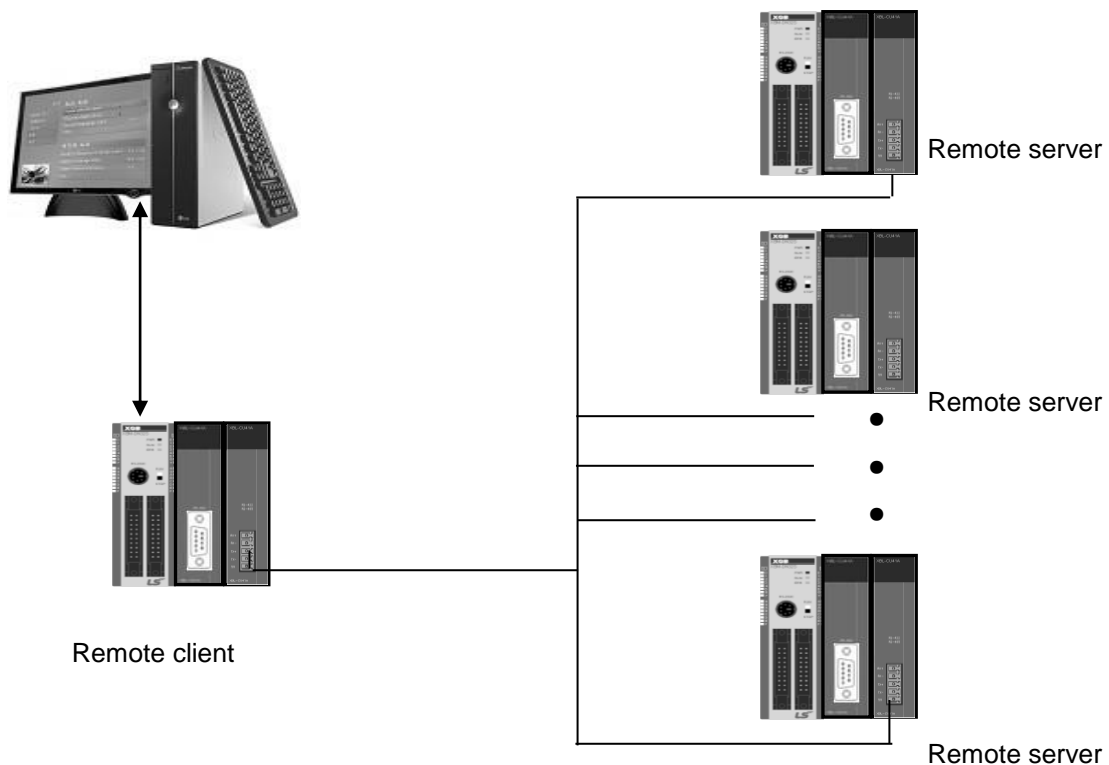

[Figure 5.1.17] Remote connection in case of RS-422/485 communication

#### Note

Basic parameter of remote server connected through XG5000 should be set as server, in case of remote client, it should be set P2P client.

If you try remote connection when there is many communications, connection may fail. You should convert PLC as Stop mode and stop communication before remote connection.

Remote connection sequence by using dedicated modem is as follows.

- (a) Set basic parameter of remote server as XGT server.
- (b) Convert local connected PLC into Stop mode.
- (c) Execute XG5000 and select "Online – Connection settings" and set connection method. And select connection method RS-232C and communication channel. This is same with case of local connection. At this time, you should set station number of remote server to connect.

# Chapter 6 Server function and P2P service

## 6.1 Server Modbus Service

Dedicated service is built-in service in Cnet I/F module. Without specific program at PLC, you can read or write information and data from PC and other device. It acts as server at communication network and if read, write request conforming XGT dedicated protocol or Modbus protocol come, it responds.

To use dedicated service, select operation mode about channel used as server among channel 1, channel of Cnet, when setting standard communication setting.

It supports XGT server and Modbus server and Modbus server responds about RTU and ASCII type.

Since each channel of Cnet I/F module acts independently, you can set as other type server. For normal operation check and diagnosis of dedicated service, refer to Chapter 9 Diagnosis.

### 6.1.1 XGT dedicated server

It is used in case of communication between our products by our dedicated service, all characters are configured as ASCII code. In case of using multi drop, up to 32 stations can be connected. In case of setting station number, duplicated station number should not be set. In case of using multi drop, communication speed/stop bit/parity bit/data bit of all Cnet I/F module in network should be same. For more detail protocol, refer to “chapter 7 XGT dedicated protocol”.

### 6.1.2 Modbus server

It is used in case partner device acts as Modbus client.

ASCII mode and RTU mode of Modbus are all supported. You can define in standard settings active mode.

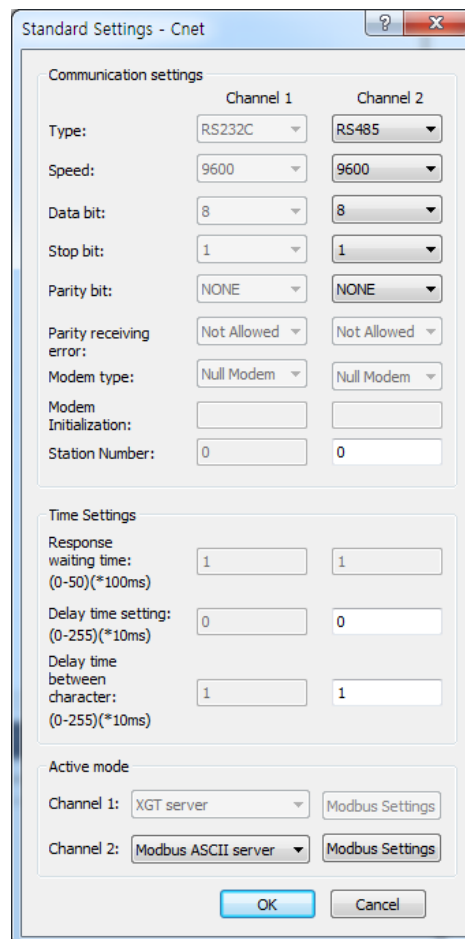

[Figure 6.1.1] Modbus server standard settings screen

Modbus instruction and response data max. number which is supported by Modbus RTU/ASCII driver are as follows.

Other client device should request in the range of the following table.

Code	Purpose	Address	Max. no. of response data
01	Read Coil Status	0XXXX	2000 Coils
02	Read Input Status	1XXXX	2000 Coils
03	Read Holding Registers	4XXXX	125 Registers
04	Read Input Registers	3XXXX	125 Registers
05	Force Single Coil	0XXXX	1 Coil
06	Preset Single Register	4XXXX	1 Register
15	Force Multiple Coils	0XXXX	1968 Coils
16	Preset Multiple Registers	4XXXX	120 Registers

[Table 6.1.1] Modbus instruction code

About request per above code, you should set area about XGB PLC memory. At 'Modbus Settings of Cnet active mode' window, if you click "Modbu Settings" button which is activated when selecting Modbus ASCII server/RTU server, the following setting window shows.

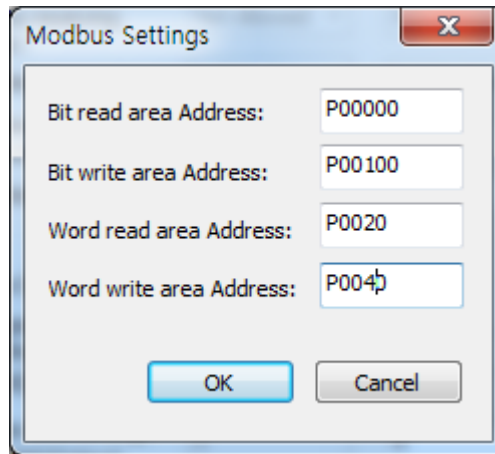

[Figure 6.1.2] Modbus server memory settings window

Meaning of each setting item is as follows.

Item	Meaning	Reference
Bit read area Address	Address of XGB relevant to digital Input area	Bit address
Bit write area Address	Address of XGB relevant to digital output area	Bit address
Word read area Address	Address of XGB relevant to analog input area	Word address
Word write area Address	Address of XGB relevant to analog output area	Word address

[Table 6.1.2] Modbus area meaning

In case of IEC type, use IEC type address value

Address value of each item is base address of each area.

The setting of above screen is the situation of allocating bit reading area from M0000 (bit) and Word writing area from D0000 (word).

Base address input value should be in XGB series internal device area.

Since address of Modbus 1~9999 (decimal number), size of bit IO area is  $9999/8=1249.875$  byte (Namely 1249, byte should be integer unit).

Also size of word IO area is  $9999*2=19998$  byte.

In case the user set 0 as base address of bit output (0XXXX) area, Modbus bit area 00001 corresponds 0<sup>th</sup> byte 0<sup>th</sup> bit, 00002 corresponds 0<sup>th</sup> byte first bit.

## 6.2 P2P Service

### 6.2.1 General

P2P service means acting client operation of communication module. P2P instructions available at Cnet I/F module are 4 (Read/Write/Send/Receive).

Registration and edit of P2P service is executed in XG5000, each P2P parameter consists of max. 32 P2P block.

The following figure is example of P2P parameter setting window of XG5000.

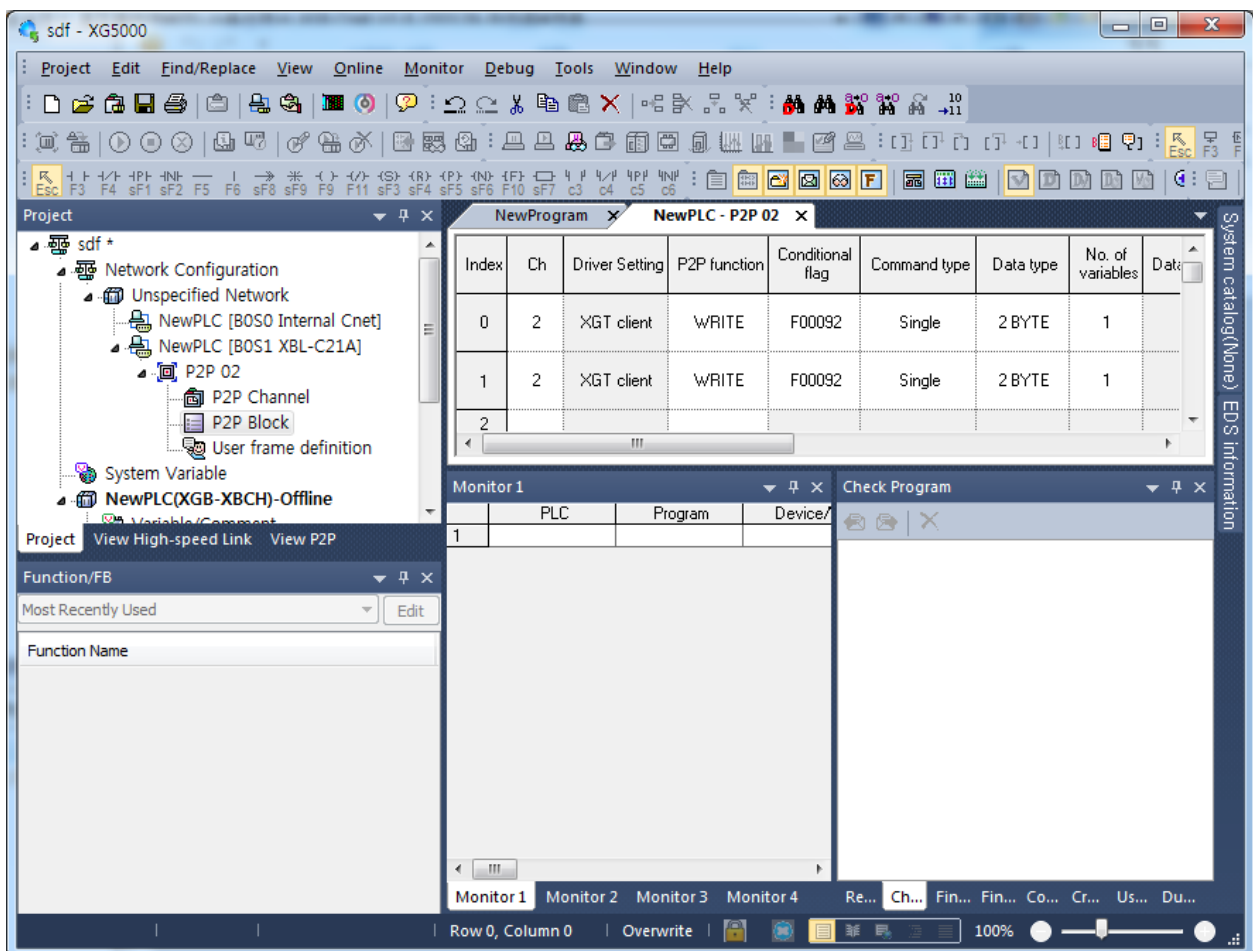

[Figure 6.2.1] P2P parameter setting example

#### Note

Note 1) P2P 01 is fixed allocated at built-in communication, P2P 02 for first communication module, P2P 03 for second communication. So slot number should be correct.



### 6.2.2 P2P parameter configuration

To use P2P service, the user executes the setting for the wanted operation at the P2P parameter window. Like the following figure, P2P parameter consists of three information.

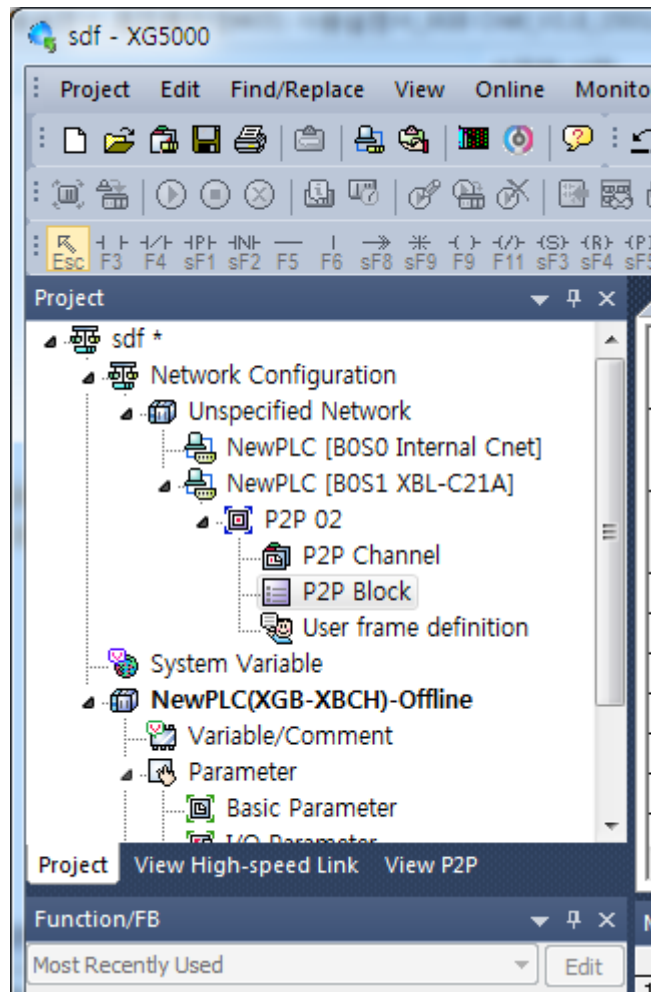

[Figure 6.2.2] P2P parameter configuration screen

- 1) P2P channel
  - P2P channel setting defining communication protocol of P2P service to execute
  - XGT/Modbus available
  - Each channel is independent. It is applied when active mode is “Use P2P settings”
- 2) P2P block
  - Setting P2P block of 32 acting independently
- 3) User frame definition
  - User frame definition registration

### 6.2.3 Channel information

Built-in Cnet I/F function provides two fixed communication channel as fixed P2P 1.

Cnet I/F module are allocated P2P 2 and P2P 3 according to equipment sequence and communication channel supports only one channel.

At Built-in Cnet I/F, you can define driver type for P2P service about each.

If you select P2P channel at P2P setting window, like the following, P2P channel setting window shows. If you select P2P driver to use, setting is complete.

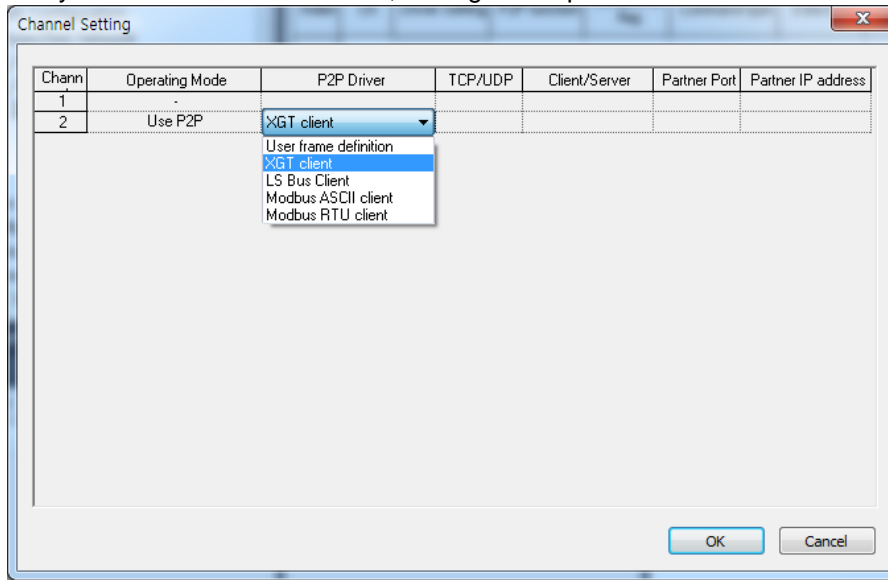

[Figure 6.2.3] P2P channel setting screen

Driver	Meaning
None	Not using P2P service
User frame definition	In case of transmitting/receiving user frame definition
XGT client	Select in case of executing read, write of XGT memory.
Modbus ASCII client	Select in case of acting as Modbus client, using ASCII mode
Modbus RTU client	Select in case of acting as Modbus client, using RTU mode.

[Table 6.2.1] Driver table

About communication channel, in case of selecting P2P driver as XGT or Modbus, user frame definition can not be used.

6.2.4 Block information

If you select P2P block of each parameter at P2P parameter setting window, P2P block setting

P2P Channel			P2P Block												
Chann	Operating Mode	P2P Driver	Index	Ch	Driver Setting	P2P function	Conditional flag	Command type	Data type	No. of variables	Data size	Destination station	Destination station number	Frame	Setting
1	Use P2P	XGT client	0	1	XGT client							<input checked="" type="checkbox"/>	0		Setting
1	Use P2P	Modbus ASCII client	0	1	Modbus ASCII client					1		<input checked="" type="checkbox"/>	0		Setting
1	Use P2P	Modbus RTU client	0	1	Modbus RTU client					1		<input checked="" type="checkbox"/>	0		Setting
1	Use P2P	User frame definition	0	1	User frame definition										Setting

window shows.

[Figure 6.2.4] P2P block setting screen

You can set up to 32 independent blocks. If you select temporary block, you can designate each block operation by selecting instruction.

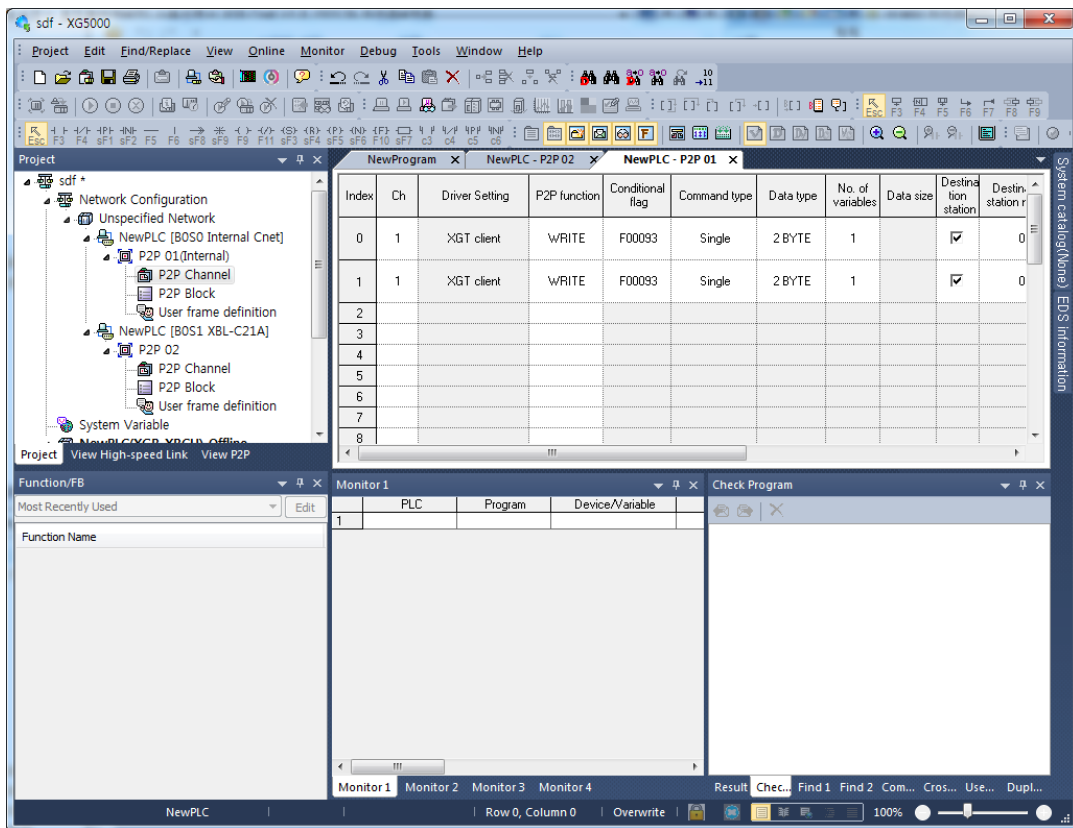

[Figure 6.2.5] P2P instruction screen

## 6.3 XGT Client Service

When communicating by using XGT protocol, XGT client requests read or write data from server and XGT server analyses received data from client then if received frame is fit to XGT protocol specification, processes requested instruction with ACK response, or is not fit to XGT protocol specification, transmits NAK response with error code to the XGT client.

### 6.3.1 Channel Setting

Cnet I/F module can set the driver type for P2P service. For P2P channel acts as client, active mode of basic setting must defined "Use P2P".

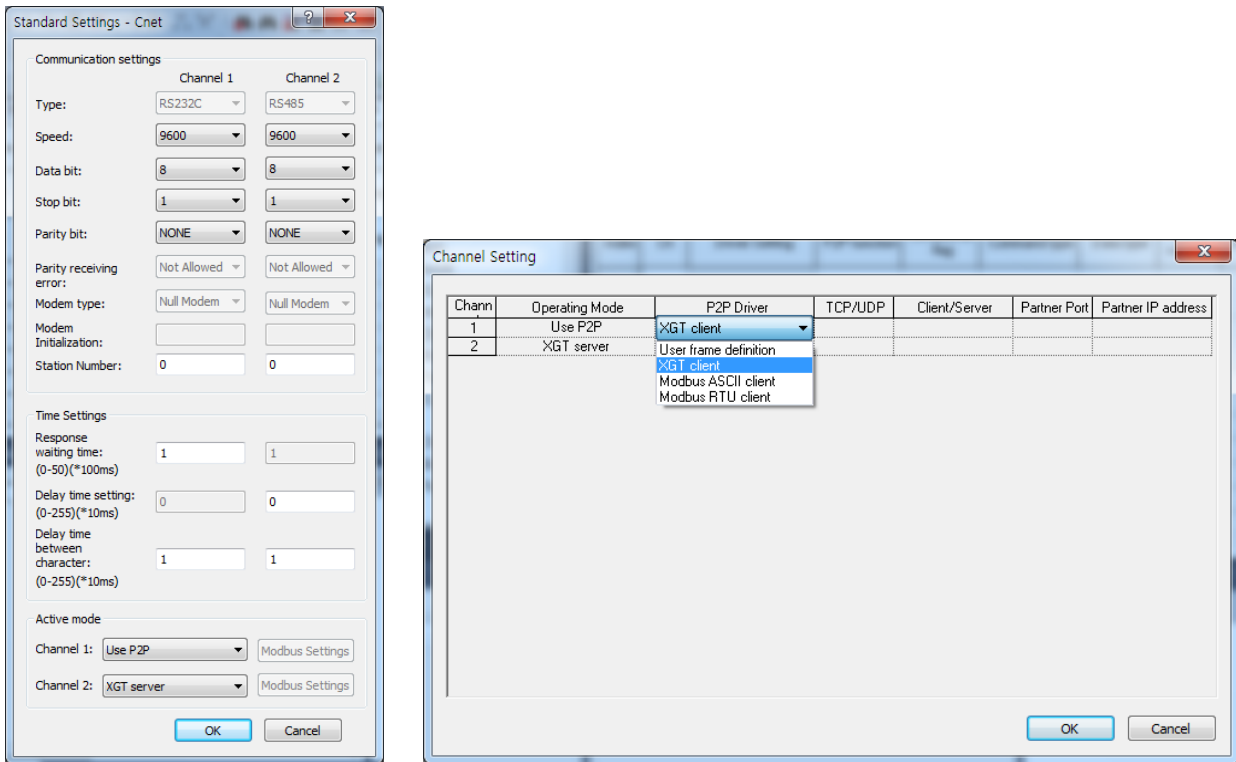





[Figure 6.3.1] P2P Channel setting

### 6.3.2 P2P Block Setting

After set the P2P channel as XGT client, you can set the P2P block.

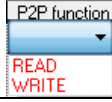
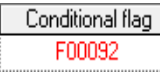
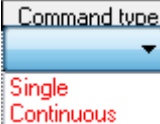
Meaning of each item is as follows.

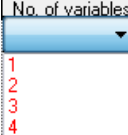
Index	Ch	Driver Setting	P2P function	Conditional flag	Command type	Data type	No. of variables	Data size	Destination station	Destination station number	Frame	Setting	Variable setting contents
0												Setting	

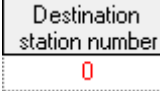
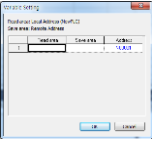
No	Item	Setting	Description
1	Channel		Driver will be changed by P2P channel setting
2	P2P function		1. READ: Select if read the data from destination station. 2. WRITE: Select if write the data to destination station.
3	Conditional flag		1. Enter the time of data transmission by using special flag or bit contact 2. XGK type: F0090(20ms cycle), M00001 2. XGI type: _T20MS(20ms cycle), %MX01
4	Command type		1. Single: Read or write max. four data of memory area to destination station. Ex) M01, M10, M20, M30 2. Continuous: Read or write continuous data to destination station Ex) M01~M10
5	Data type		1. Command type is single - BIT, 1BYTE, 2BYTE, 4BYTE, 8BYTE 2. Command type is continuous - 1BYTE, 2BYTE, 4BYTE, 8BYTE
6	No. of variables		1. It is activate when command type is single. Select number of data to transmission. 2. It will be fixed 1 when command type is continuous
7	Data size		1. It is activate when command type is continuous. Setting range is 1~120byte. (In case of data type is 1BYTE)
8	Destination station number		1. It means destination station number and setting range is 0~31.
9	Setting		1. P2P function is READ 1) Read area: Device area of data saved in destination station(server) 2) Save area: Device area of self station to save the data 2. P2P function is WRITE 1) Read area: Device area of data saved in self station 2) Save area: Device area of destination station area to save the data

### 6.3.3 Parameter Write

After completed the P2P block setting, download the parameter to CPU.

Select [Online]→[Write] on the menu, click [OK] in the parameter download window. After download is complete, parameter will be right applied.

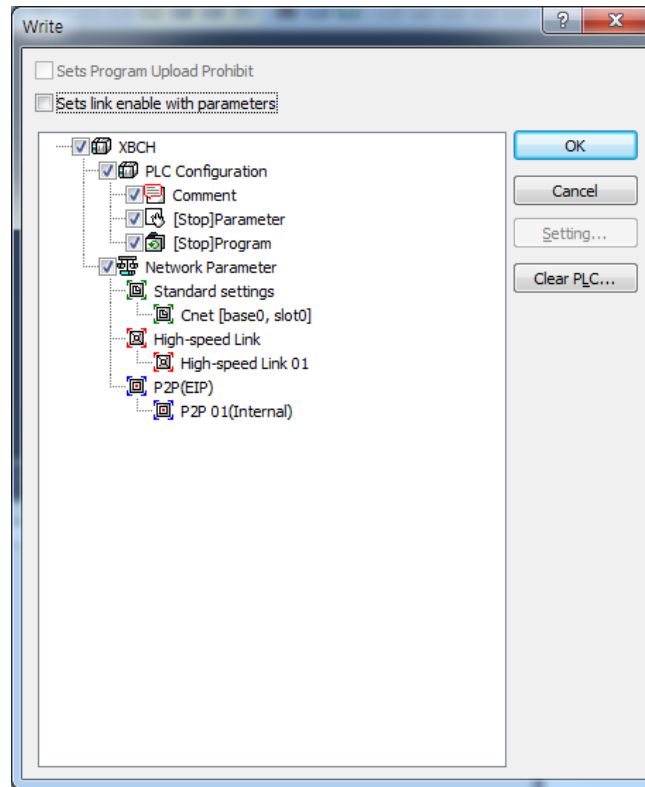

[Figure 6.3.2] Parameter write

### 6.3.4 Enable Link

After completed the parameter download, user must enabling the P2P service. If user complete the parameter download but do not enabling the P2P(IEP), P2P block will not work.

Select [Online]→[Communication Module Setting]→[Enable Link] and check the P2P(EIP) to use, then P2P will be activated.

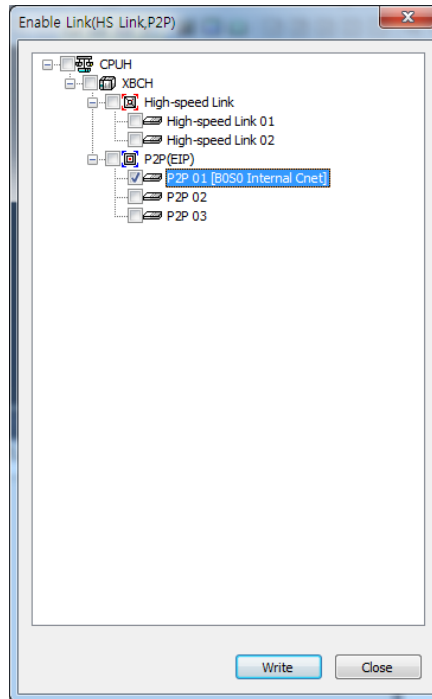

[Figure 6.3.3] Enable P2P Link

### 6.3.5 Diagnosis

User can check the normal operation to using diagnosis feature.

Select [Online]→[Communication module setting]→[System diagnosis]. Right click on the module to check and select frame monitor or status by service. Then user can check the communication status.

For more information, please refer to the Chapter 10 Diagnosis.

## 6.4 Modbus Client Service

Modbus protocol is a standardized open protocol for client-server communication. It operates send/receive data by function code. Device to device communication using Modbus protocol, use client-server feature to handle only one client.

### 6.4.1 Channel Setting

Cnet I/F module can set the driver type for P2P service. For P2P channel acts as client, active mode of basic setting must defined "Use P2P".

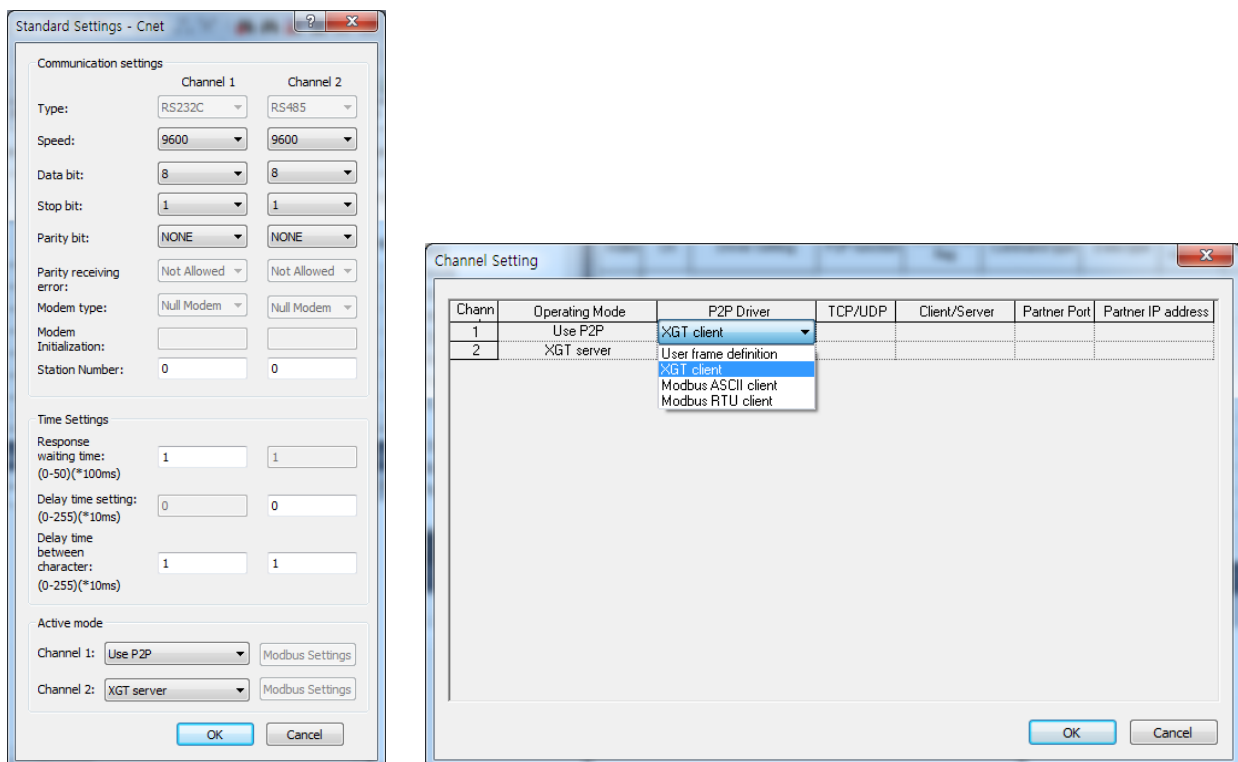



[Figure 6.4.1] P2P Channel setting



6.4.2 P2P Block Setting

The operation using Modbus RTU/ASCII client has read function that read the data from destination station and write function that write the data to destination station. Modbus RTU/ASCII client block setting is as follows.

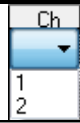
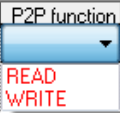
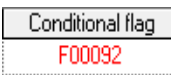
Index	Ch	Driver Setting	P2P function	Conditional flag	Command type	Data type	No. of variables	Data size	Destination station	Destination station number	Frame	Setting	Variable setting contents
0												Setting	

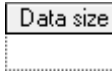
No	Item	Setting	Description
1	Channel		Driver will be changed by P2P channel setting
2	P2P function		1. READ: Select if read the data from destination station. 2. WRITE: Select if write the data to destination station.
3	Conditional flag		1. Enter the time of data transmission by using special flag or bit contact 2. XGI type: F0090(20ms cycle), M00001 2. XGI type: _T20MS(20ms cycle), %MX01
4	Command type		1. Single: Read or write max. four data of memory area to destination station. Ex) M01, M10, M20, M30 2. Continuous: Read or write continuous data to destination station Ex) M01~M10
5	Data type		Data type can be set BIT or WORD
6	Data size		<p>▷ It is activate when command type is continuous.</p> <p>1. In case of P2P function is READ</p> <p>1) Modbus RTU client (1) BIT: 1~2000 (2) WORD: 1~120</p> <p>2) Modbus ASCII client (1) BIT: 1~976 (2) WORD: 1~61</p> <p>2. In case of P2P function is WRITE</p> <p>1) Modbus RTU client (1) BIT: 1~1968 (2) WORD: 1~120</p> <p>2) Modbus ASCII client (1) BIT: 1~944 (2) WORD: 1~120</p>

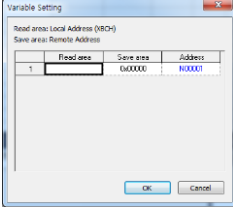
7	Detestation station number	<div style="border: 1px solid black; padding: 2px; width: fit-content; margin: auto;">Destination station number</div> <div style="text-align: center; color: red; font-weight: bold; margin-top: 5px;">0</div>	1. It means destination station number and setting range is 0~31.
8	Setting		<ol style="list-style-type: none"> <li>1. Read area: Device area of data saved in destination station(server) BIT Input(0x10000), WORD Input(0x30000),</li> <li>2. Save area: Device area of self station to save the data BIT Output(0x00000), WORD Output(0x40000)</li> </ol>

### 6.4.3 Parameter Write

After completed the P2P block setting, download the parameter to CPU.

Select [Online]→[Write] on the menu, click [OK] in the parameter download window. After download is complete, parameter will be right applied.

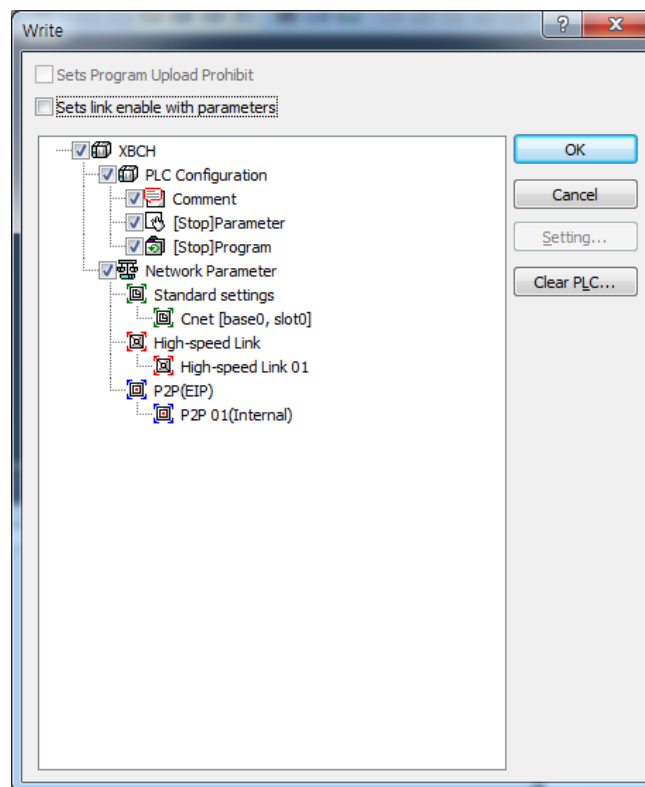

[Figure 6.4.2] Parameter write

### 6.4.4 Enable Link

After completed the parameter download, user must enabling the P2P service. If user complete the parameter download but do not enabling the P2P(IEP), P2P block will not work.

Select [Online]→[Communication Module Setting]→[Enable Link] and check the P2P(EIP) to use, then P2P will be activated.

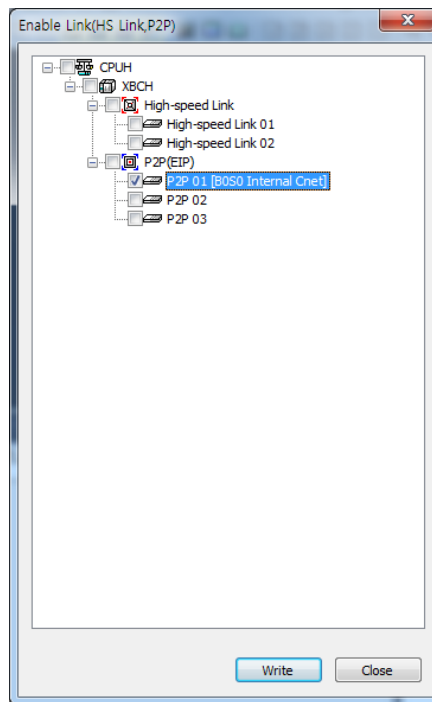

[Figure 6.4.3] Enable P2P Link

### 6.4.5 Diagnosis

User can check the normal operation to using diagnosis feature.

Select [Online]→[Communication module setting]→[System diagnosis]. Right click on the module to check and select frame monitor or status by service. Then user can check the communication status.

For more information, please refer to the Chapter 10 Diagnosis.

## 6.5 User Frame Definition

There are many protocols according to producer of communication device and it is impossible to supports diverse protocols. So if the user defines protocols and writes program, Cnet I/F module allows the communication between different devices according to defined protocol. In order to communicate with device which doesn't use specific protocols (XGT protocol, Modbus protocol), the user can directly define protocol used in the device the user want to communicate and communicate. At this time, the user should define TX and RX frame so that it meets partner device's protocol.

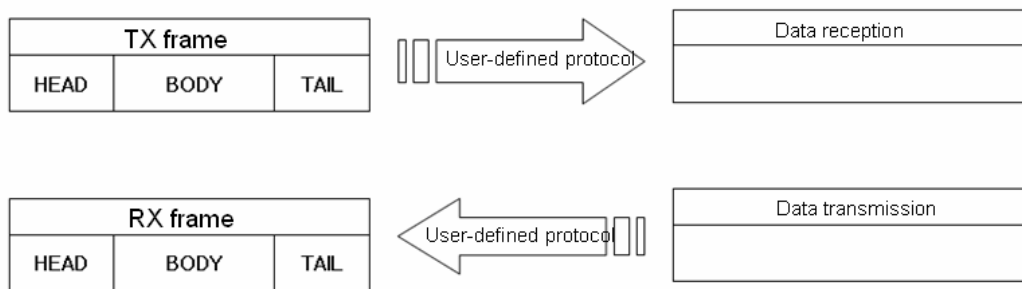

[Figure 6.5.1] User frame definition

### 6.5.1 Structure of user definition frame

When writing frame by user definition frame, frame is divided into HEAD that start of frame, TAIL that end of frame and BODY that data area. Each HEAD, TAIL and BODY is divided into segment. Total size of one frame should be less than 1024 byte.

Frame		
HEAD	BODY	TAIL
Segment 1	Segment 1	Segment 1
Segment 2	Segment 2	Segment 2
Segment 3	Segment 3	Segment 3
Segment N	Segment N	Segment N

#### 1) Structure of HEAD

Input type of segment for HEAD is divided into numerical constant and string constant.

In case of numerical constant, it means HEX value and in case of string constant, it means ASCII value.

#### 2) Structure of TAIL

Input type of segment for HEAD is divided into numerical constant, string constant and BCC which check frame error. Meaning of numerical constant and string constant is same with HEAD's. BCC is segment

used for checking TRX frame error, only one can be set in the TAIL.

### ◆ BCC error check

It is the meaning that the numerical value and the character string which are used in HEAD are used to be equal. BCC is the segment which is used to inspect the error of the TRX frame. It can only set Tail. When BCC is applied, calculation about TRX frame is executed and if calculation is different, relevant frame is ignored to improve the reliability of communication. Calculation methods about each BCC are as follows.

Classification	BCC method	Contents description
General method checking error	Byte SUM	Adds designated data as 1 byte unit and uses lower byte value
	Word SUM	Adds designated data as 1 word unit and uses lower word value
	Byte XOR	Executes Exclusive OR calculation about designated data as 1 byte unit and uses lower byte
	7bit SUM	Uses result value of byte sum except the most significant bit
	7bit XOR	Uses result value of byte XOR except the most significant bit
	7bit SUM#1	If result of 7 bit SUM is less than 20 <sub>H</sub> , it adds 20 <sub>H</sub> .
	Byte SUM 2'S COMP	Takes 2's complement about byte sum result
	Byte SUM 1'S COMP	Takes 1's complement about byte sum result
	CRC 16	16 bit error detection method
Method checking error for dedicated communication	LGIS CRC	Error detection method used for LSIS PLC
	DLE AB	Error detection method used for DF1 Protocol of Allen Bradley
	DLE SIEMENS	Error detection method used for Siemens 3964R communication

When setting BCC, in case of general method, the user need not set BCC setting range and indication method and in case of dedicated method, the user should set BCC setting range and indication method.

Item		Contents
Start position	Start area	Determines where BCC calculation starts from among HEAD/BODY/TAIL
	Segment	Determines segment location to start BCC calculation in HEAD/BODY/TAIL. 0 means first segment will be included in the BCC calculation
End position	Before BCC	Included from start position to before BCC
	End of area	Included from start position to end of designated area
	Settings	Included from start position to designated area segment
ASCII conversion		Converts result value, its size will be double
Initial value 0		Designates BCC initial value as 0. If there is no designation, initial value is FF <sub>H</sub> .

### 3) Structure of BODY

Input type of segment which composes BODY is different according to receive and transmission. In case of transmission, they are divided into string constant, numerical constant and fix sized variable. Meaning of string constant and numerical constant is same with HEAD's.

#### (1) Variable sized variable (in RX frame)

Part where size and contents changes are defined as variable sized variable. Variable sized variable can be set in the BODY and after variable sized variable, the user can't add segment. When using variable sized variable, there should be one among HEAD, TAIL. If the user registers variable sized variable without HEAD, TAIL, when receiving frame, there may be error according to communication status. For reliability of communication, register one among HEAD, TAIL. (In case of Variable sized variable of TX frame, the size is designated in P2P Block setting, so the function and characteristic is same with Fix sized variable of RX frame.)

#### (2) Fix sized variable (in RX frame)

Frame part where size is fixed but contents changes are defined as Fix sized variable. It can be set in the BODY. In case of Fix sized variable, the user can register up to 4.

TRX frame standard for user - defined communication of XGT Cnet I/F module is as follows.

Group	Frame	Segment	Reference
TX frame	HEAD	Numerical constant	Max. 10 byte
		String constant	Max. 10 byte
	TAIL	Numerical constant	Max. 10 byte
		String constant	Max. 10 byte
		BCC	Only one BCC applicable
	BODY	Numerical constant	Max. 10 byte
		String constant	Max. 10 byte
		Variable sized variable	Available up to 4
	RX frame	HEAD	Numerical constant
String constant			Max. 10 byte
TAIL		Numerical constant	Max. 10 byte
		String constant	Max. 10 byte
		BCC	Only one BCC applicable
BODY		Numerical constant	Max. 10 byte
		String constant	Max. 10 byte
		Fix sized variable	Available up to 4 Fix sized variable 3, variable sized variable 1 are available
		Variable sized variable	Only one variable sized variable available After variable sized variable, adding segment is impossible

### 6.5.2 Channel Setting

Cnet I/F module can set the driver type for P2P service. For P2P channel acts as client, active mode of basic setting must defined "Use P2P".

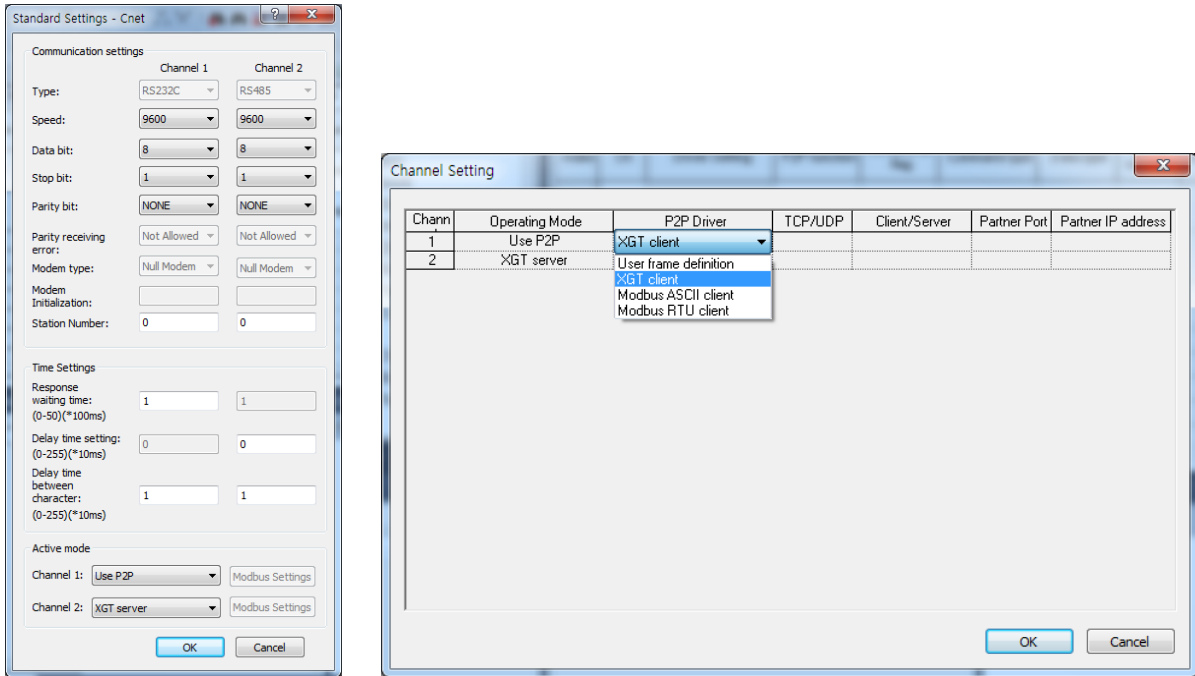

[Figure 6.5.2] P2P Channel setting

### 6.5.3 Writing transmission frame

Frame is composed of HEAD indicating start, TAIL indicating end and BODY which is data area. How to write transmission frame is as follows.

Seq.	Setting	Setting method
1	Writing user frame definition	<p>1. Select User frame definition 2. Click right button of mouse and click Add Group</p>
2	Creating frame	<p>1. Group name is name of frame for user to write 2. Select Transmission as frame type</p>

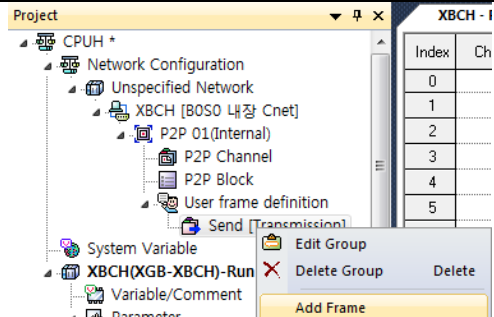
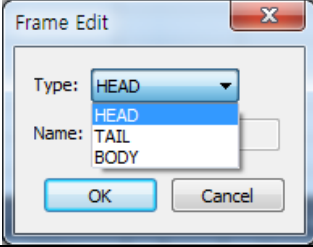
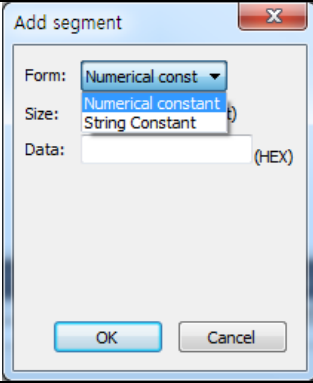
Seq.	Setting	Setting method
3	Creating frame	
<ol style="list-style-type: none"> <li>1. Check creation of frame</li> <li>2. Select frame name and click right button of mouse.</li> <li>3. Click Add frame to create HEAD, TAIL and BODY</li> <li>4. Group Edit: when changing frame name</li> <li>5. Delete Group: when deleting frame</li> </ol>		
4	Creating HEAD, TAIL, BODY	
<ol style="list-style-type: none"> <li>1. After clicking Add frame, select type of frame</li> <li>2. Type: HEAD, TAIL, BODY</li> <li>3. Select HEAD</li> <li>4. To create TAIL, BODY, repeat step 3</li> <li>5. Name of frame edit window is activated when frame type is BODY</li> <li>6. Available to creating many BODYs with different name</li> </ol>		
5	HEAD registration	
<ol style="list-style-type: none"> <li>1. Double-click HEAD. Then edit window is created.</li> <li>2. Double-click edit window or click right button and select Add segment</li> <li>3. Select Form             <ol style="list-style-type: none"> <li>1) Numerical constant                 <ol style="list-style-type: none"> <li>(1) Defines numerical constant among frame</li> <li>(2) Data value is always Hex (Hexadecimal)</li> </ol> </li> <li>2) String constant                 <ol style="list-style-type: none"> <li>(1) Registers string constant among frame</li> <li>(2) Data value is always ASCII</li> </ol> </li> </ol> </li> <li>4. Input value into Data             <p>Ex) Form: Numerical constant Data: 5(ENQ)</p> </li> </ol> <p>* When clicking the right button on the created segment, edit, deletion, insertion, copy, etc. are available.</p>		

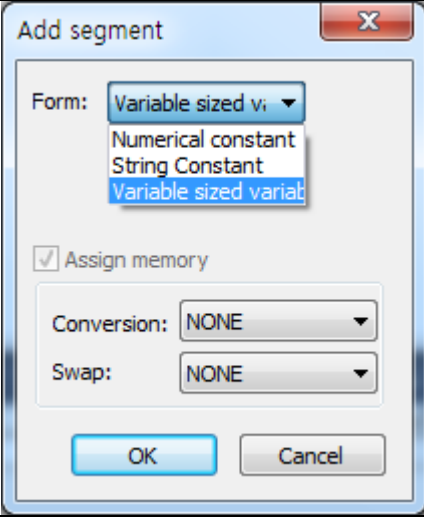

Seq.	Setting	Setting method
6	TAIL registration	1.If double-click TAIL, edit window shows 2. Setting method is same with step 5 3. Add BCC is activated after inserting segment
7	BODY registration	
		1. Double-click BODY and select data form 1) Numerical constant and string constant are same as described above. 2) Variable sized variable (1) used when frame length change (2) available to insert up to 4 for one body (3) 'Assign memory' is checked automatically (4) Control by byte unit 3) Conversion ▶ Hex to ASCII: converts the data read from PLC into ASCII and configures transmission frame ▶ ASCII to Hex: converts the data read from PLC into Hex and configures transmission frame 4) Swap ▶ 2 Byte swap: 2 byte swap of data. Ex) 0x1234→0x3412 ▶ 4 Byte swap: 4 byte swap of data. Ex) 0x12345678→0x78563412 ▶ 8 Byte swap: 8 byte swap of data

6.5.4 Writing receive frame

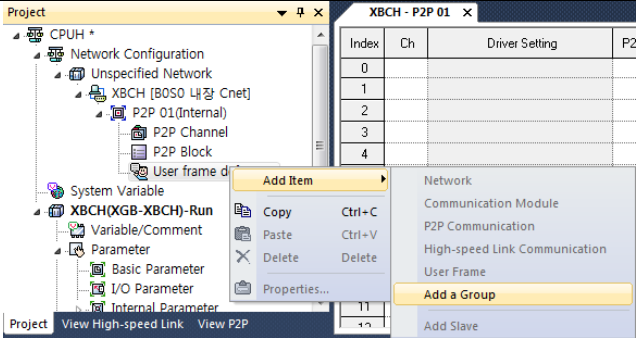
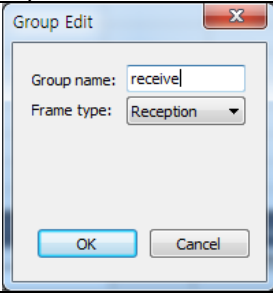
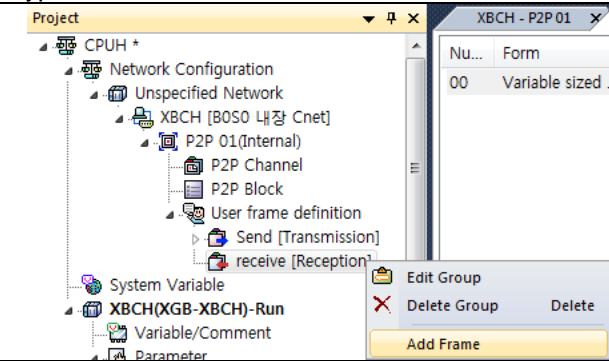
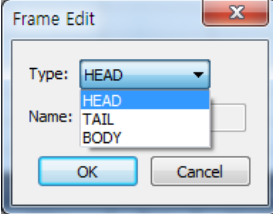
Seq.	Setting	Setting method
1	Writing user frame definition	
		<ol style="list-style-type: none"> <li>1. Select User frame definition</li> <li>2. Click right button of mouse and click Add Group</li> </ol>
2	Creating frame	
		<ol style="list-style-type: none"> <li>1. Group name is name of frame for user to write</li> <li>2. Select Transmission as frame type</li> </ol>
3	Creating frame	
		<ol style="list-style-type: none"> <li>1. Check creation of frame</li> <li>2. Select frame name and click right button of mouse.</li> <li>3. Click Add frame to create HEAD, TAIL and BODY</li> <li>4. Group Edit: when changing frame name</li> <li>5. Delete Group: when deleting frame</li> </ol>
4	Creating HEAD, TAIL, BODY	
		<ol style="list-style-type: none"> <li>1. After clicking Add frame, select type of frame</li> <li>2. Type: HEAD, TAIL, BODY</li> <li>3. Select HEAD</li> <li>4. To create TAIL, BODY, repeat step 3</li> <li>5. Name of frame edit window is activated when frame type is BODY</li> <li>6. Available to creating many BODYs with different name</li> </ol>

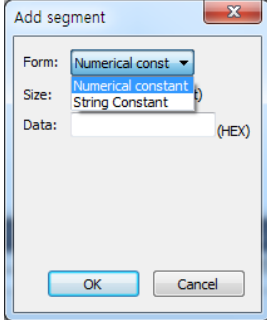
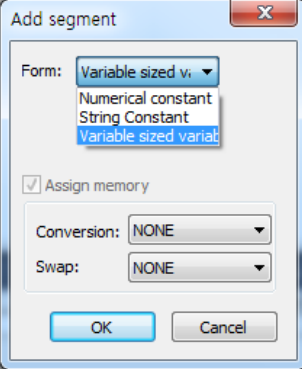



Seq.	Setting	Setting method
5	HEAD registration	
<ol style="list-style-type: none"> <li>1. Double-click HEAD. Then edit window is created.</li> <li>2. Double-click edit window or click right button and select Add segment</li> <li>3. Select Form               <ol style="list-style-type: none"> <li>1) Meaning of each form is same as described in the transmission</li> </ol> </li> <li>4. Input value into Data</li> </ol>		
6	TAIL registration	<ol style="list-style-type: none"> <li>1.If double-click TAIL, edit window shows</li> <li>2. Setting method is same with step 5</li> <li>3. Add BCC is activated after inserting segment</li> </ol>
	BODY registration	
7		<ol style="list-style-type: none"> <li>1. Double-click BODY and select data form           <ol style="list-style-type: none"> <li>1) Numerical constant and string constant are same as described above.</li> <li>2) Variable sized variable               <ol style="list-style-type: none"> <li>(1) used when frame length change</li> <li>(2) available to insert up to 4 for one body</li> <li>(3) 'Assign memory' is checked automatically</li> <li>(4) Control by byte unit</li> </ol> </li> <li>3) Fix sized variable               <ol style="list-style-type: none"> <li>(1) Used when frame size is fixed</li> <li>(2) available to insert up to 4 for one body</li> <li>(3) When checking 'Assign memory', it is available to save in the PLC memory</li> </ol> </li> </ol> </li> <li>4. Assign memory: when setting the device area of PLC to save data</li> <li>5) Conversion           <ol style="list-style-type: none"> <li>▶ Hex to ASCII: converts the data read from PLC into ASCII and configures transmission frame</li> <li>▶ ASCII to Hex: converts the data read from PLC into Hex and configures transmission frame</li> </ol> </li> <li>6) Swap           <ol style="list-style-type: none"> <li>▶ 2 Byte swap: 2 byte swap of data. Ex) 0x1234→0x3412</li> <li>▶ 4 Byte swap: 4 byte swap of data. Ex) 0x12345678→0x78563412</li> <li>▶ 8 Byte swap: 8 byte swap of data</li> </ol> </li> </ol>

### 6.5.5 Parameter setting

To send and receive the user definition frame of XG-PD, the user should set the parameter by P2P block. How to set the P2P block is as follows.

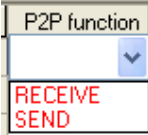
Index	Ch.	Driver Setting	P2P function	Conditional flag	Command type	Data type	No. of variable	Data size	Destination	Destinatio	Frame	Setting
0	2	User frame definition										Setting
	①		②	③							④	⑤

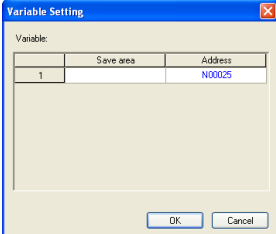

No.	Type	Block type	Meaning
1	Channel		Driver name changes according to driver set in the P2P Driver.
2	P2P Function		<ol style="list-style-type: none"> <li>1. Receive: used when receiving the frame written according to partner's protocol</li> <li>2. Send: used when sending the frame written according to partner's protocol</li> </ol>
3	Conditional flag		<ol style="list-style-type: none"> <li>1. Determines when Cent sends frame</li> <li>2. It is activated when P2P function is [Send].</li> <li>3. In case of XGK type Ex.: F90(20ms flag), M01</li> <li>4. In case of XGI type Ex.: _T20MS(20ms flag), %MX01</li> </ol>
4	Frame		1. In case of selecting [SEND] in the P2P function, select body of transmission frame written in the user definition frame.
			1. In case of selecting [RECEIVE] in the P2P function, select body of receive frame written in the user definition frame.
5	Setting		<ol style="list-style-type: none"> <li>1. Setting is available when [Assign memory] of Fix sized variable and variable sized variable is checked.</li> <li>2. Save area: start address to save the data received from destination station.</li> </ol>

### 6.5.6 Parameter Write

After completed the P2P block setting, download the parameter to CPU.

Select [Online]→[Write] on the menu, click [OK] in the parameter download window. After download is complete, parameter will be right applied.

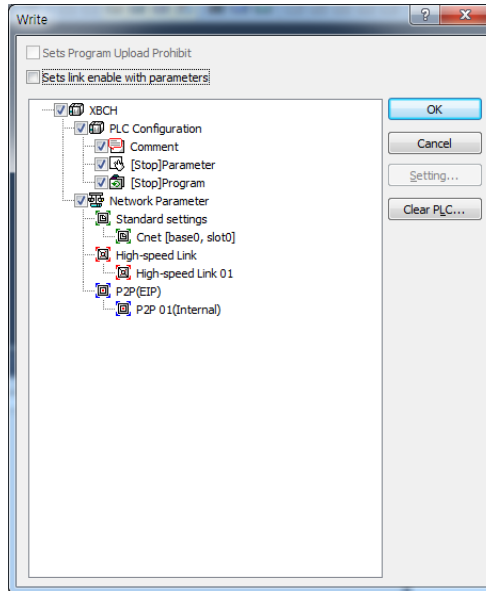

[Figure 6.5.3] Parameter write

### 6.5.7 Enable Link

After completed the parameter download, user must enabling the P2P service. If user complete the parameter download but do not enabling the P2P(IEP), P2P block will not work.

Select [Online]→[Communication Module Setting]→[Enable Link] and check the P2P(EIP) to use, then P2P will be activated.

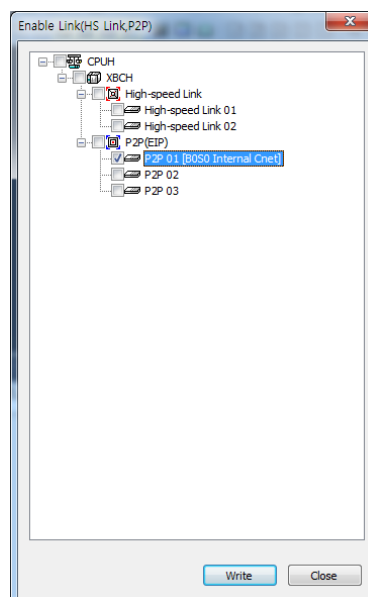

[Figure 6.5.4] Enable P2P Link

### 6.5.8 Diagnosis

User can check the normal operation to using diagnosis feature.

Select [Online]→[Communication module setting]→[System diagnosis]. Right click on the module to check and select frame monitor or status by service. Then user can check the communication status.

For more information, please refer to the Chapter 10 Diagnosis.

## 6.6 UDATA Instruction

### 6.6.1 SEND\_UDATA [IEC]

SEND_UDATA	Availability	Flags
User defined data send	XGI, XGR	-
Function Block	Description	
<pre> graph LR     subgraph SEND_UDATA         REQ[REQ]         BASE[BASE]         SLOT[SLOT]         CH[CH]         DATA[DATA]         SIZE[SIZE]         DONE[DONE]         STAT[STAT]     end     REQ --- DONE     BASE --- STAT     </pre>	<p><b>Input</b></p> <ul style="list-style-type: none"> <li>REQ: requires to execute the function block</li> <li>BASE : base number</li> <li>SLOT: slot number</li> <li>CH: channel(1 or 2)</li> <li>DATA: data area to send</li> <li>SIZE: data size to send</li> </ul> <p><b>Output</b></p> <ul style="list-style-type: none"> <li>DONE: maintains 1 after operation</li> <li>STAT: completion and ERR info</li> </ul>	

(a) Function

- 1) SEND\_UDATA instruction sends user defined data(UDATA).
- 2) BASE and SLOT should input a base and the slot number that CNET module was attached to now.
- 3) CH means a channel number and must set 1 or 2
- 4) DATA must be declared only ARRAY OF BYTE type.
- 5) Array size is 1 ~ 1024 byte.
- 6) Save to transmit buffer as number as SIZE from DATA[0].  
(Limit of data size is 1024 at once)
- 7) If 1 is output by Done and STAT, it accomplished normally and If an error is produced, state information is displayed by STAT.

(b) Error

STAT	Message	Description
0	Initial state	Initial state before instruction operation
1	No error	normal operation
2	Module setting error	Module is not installed or CNET module trouble
3	Channel setting error	Input range(1, 2) is exceeded
4	Array size error	Transmit data size exceed 1024
5	Parameter setting error	CNET module's parameter is not set as User defined or link enable is not set
6	Instruction timeout error	No response from module or maximum scan time is exceeded(10 scan)
7	Version mismatch error	XGI CPU version is under V3.9, XGR CPU version is under V2.6 or CNET module version is under V3.2

(c) Program example

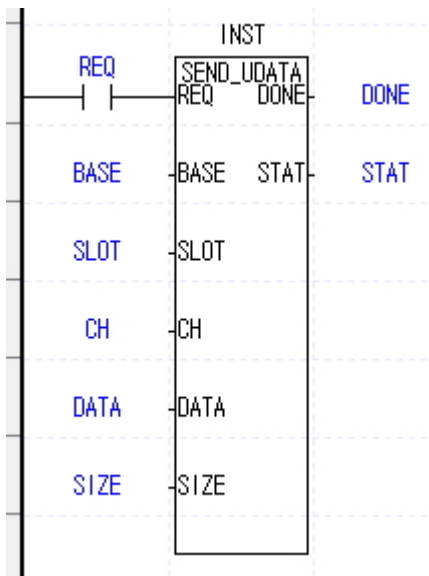

Order to send up to 1,024 Byte with CNET module attached to BASE, SLOT



6.6.2 RCV\_UDATA [IEC]

RCV_UDATA	Availability	Flags
User defined data send	XGI, XGR	-
Function Block	Description	
	<p><b>Input</b></p> <ul style="list-style-type: none"> <li>REQ: requires to execute the function block</li> <li>BASE : base number</li> <li>SLOT: slot number</li> <li>CH: channel(1 or 2)</li> <li>DATA: data area to save</li> </ul> <p><b>Output</b></p> <ul style="list-style-type: none"> <li>DONE: maintains 1 after operation</li> <li>STAT: completion and ERR info</li> <li>SIZE: received data size</li> </ul>	

(a) Function

- 1) RCV\_UDATA instruction saves received user defined data(UDATA) from CNET module.
- 2) BASE and SLOT should input a base and the slot number that CNET module was attached to now.
- 3) CH means a channel number and must set 1 or 2
- 4) DATA must be declared only ARRAY OF BYTE type.
- 5) Array size is 1 ~ 1024 byte.
- 6) Save to transmit buffer as number as SIZE from DATA[0]. (Limit of data size is 1024 at once)
- 7) If 1 is output by Done and STAT, it accomplished normally and If an error is produced, state information is displayed by STAT

(b) Error

STAT	Message	Description
0	Initial state	Initial state before instruction operation
1	No error	normal operation
2	Module setting error	Module is not installed or CNET module trouble
3	Channel setting error	Input range(1, 2) is exceeded
4	Array size error	Transmit data size exceed 1024
5	Parameter setting error	CNET module's parameter is not set as User defined or link enable is not set
6	Instruction timeout error	No response from module or maximum scan time is exceeded(10 scan)
7	Version mismatch error	XGI CPU version is under V3.9, XGR CPU version is under V2.6 or CNET module version is under V3.2

6.6.3 SEND\_DTR [IEC]

SEND_DTR	Availability	Flags
DTR signal send	XGI, XGR	-
Function Block	Description	
	<p>Input</p> <p>REQ: requires to execute the function block                      BASE : base number                      SLOT: slot number                      CH: channel(1 or 2)                      DTR: 0 or 1</p> <p>Output</p> <p>DONE: maintains 1 after operation                      STAT: completion and ERR info</p>	

(a) Function

- 1) SEND\_DTR instruction send DTR(Data Terminal Ready) signal that means communication ready complete.
- 2) If 1 is output by Done and STAT, it accomplished normally and If an error is produced, state information is displayed by STAT

(b) ERROR

STAT	Message	Description
0	Initial state	Initial state before instruction operation
1	No error	normal operation
2	Module setting error	Module is not installed or CNET module trouble
3	Channel setting error	Input range(1, 2) is exceeded
4	DTR setting error	Input range(0, 1) is exceeded
5	Parameter setting error	CNET module's parameter is not set as User defined or link enable is not set
6	Instruction timeout error	No response from module or maximum scan time is exceeded(10 scan)
7	Version mismatch error	XGI CPU version is under V3.9, XGR CPU version is under V2.6 or CNET module version is under V3.2

6.6.4 SEND\_RTS [IEC]

SEND_RTS	Availability	Flags
RTS signal send	XGI, XGR	-
Function Block	Description	
	<p>Input</p> <p>REQ: requires to execute the function block            BASE : base number            SLOT: slot number            CH: channel(1 or 2)            RTS: 0 or 1</p> <p>Output</p> <p>DONE: maintains 1 after operation            STAT: completion and ERR info</p>	

(a) Function

- 1) SEND\_DTR instruction send DTR(Data Terminal Ready) signal that means communication ready complete.
- 2) If 1 is output by Done and STAT, it accomplished normally and If an error is produced, state information is displayed by STAT.

(b) ERROR

STAT	Message	Description
0	Initial state	Initial state before instruction operation
1	No error	normal operation
2	Module setting error	Module is not installed or CNET module trouble
3	Channel setting error	Input range(1, 2) is exceeded
4	RTS setting error	Input range(0, 1) is exceeded
5	Parameter setting error	CNET module's parameter is not set as User defined or link enable is not set
6	Instruction timeout error	No response from module or maximum scan time is exceeded(10 scan)
7	Version mismatch error	XGI CPU version is under V3.9, XGR CPU version is under V2.6 or CNET module version is under V3.2

6.6.5 SNDUDATA [MK]

Instruction	Area Available															Step	Flag		
	PM K	F	L	T	C	S	Z	D.x	R.x	Const	U	N	D	R	Error (F110)		Zero (F111)	Carry (F112)	
SNDUDATA	sl	-	-	-	-	-	-	-	-	0	-	-	-	-	4~7	0	-	-	
	S1	0	-	0	-	-	-	0	-	0	0	0	0						
	S2	0	-	0	-	-	-	0	-	-	0	0	0						
	S3	0	-	0	-	-	-	0	-	-	0	0	0						
	D	0	-	0	-	-	-	0	-	-	0	0	0						

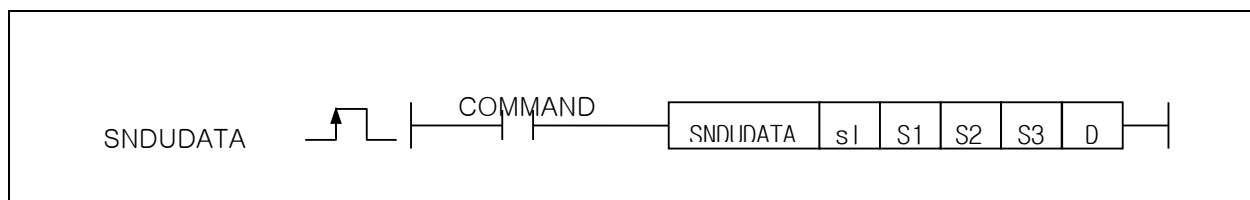

[Area Setting]

Operand	Description	Data type
sl	Base and slot number	WORD
S1	Channel (1 or 2)	WORD
S2	Data area to send	WORD
S3	Data size to send (maximum 1024 Byte)	WORD
D	Temporary device that used in instruction	WORD

[Flag Setting]

Flag	Description	Device Number
Error	If sl value is not matched with CNET module installed.	F110

(a) SNDUDATA

- 1) SNDUDATA instruction sends user defined data(UDATA).
- 2) sl is base and slot number of CNET module installed.
- 3) S1 is channel number (1 or 2).
- 4) S2 is start device to send UDATA
- 5) S3 is size of UDATA, instruction sends the number of S3 from S2(Maximum 1024 Byte).
- 6) D is temporary device area to save instruction information. Initial value is 0 and If user change that value, instruction is not operated normally.

CPU Device	Data size	Information
D	WORD	State code
D+1	WORD	Reserved area (Prohibition on Use)
D+2	WORD	
D+3	WORD	

## Chapter 6 Server function and P2P service

(b) Error

- 1) If sl value is not matched with CNET module installed, set error flag(F110).

(c) State Information

State code	State	Information
00	Initial state	Before excute instruction
01	Done	Instruction excute complete
02	Modlue setting error	If sl value is not matched with CNET module installed
03	Channel setting error	S1 value is not 1 or 2
04	Data size setting error	Size if data to send exceeds range(0~1024)
05	Communication parameter setting error	If parameter of CNET module is not set as user defined data, or when Link enable is not set
06	Timeout error	No response casue of abnormal CNET module
07	Verseion mismatch	CNET OS version is below V3.2 (If CPU version is below V4.2, program download in not operated )

(d) Program Example

- 1) If Input signal REQ, Order to send up to SIZE with CNET module attached to BASE, SLOT

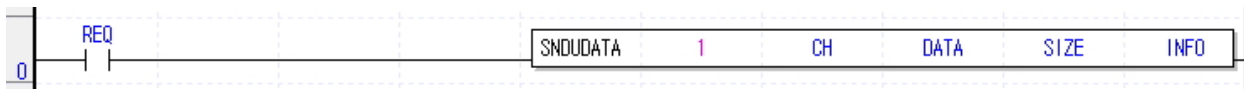

### Remark

(1) Devices D+1 ~ D+3 set in operand D are the areas to be saved with instruction information. So users must not change that areas. If change that areas, instruction is not operated normally.

6.6.6 RCVUDATA [MK]

Instruction	Area Available														Step	Flag			
	PMK	F	L	T	C	S	Z	D.x	R.x	Con st	U	N	D	R		Error (F110)	Zero (F111)	Carry (F112)	
SNDUDATA	sl	-	-	-	-	-	-	-	-	-	O	-	-	-	-	4~7	O	-	-
	S1	O	-	O	-	-	-	O	-	-	O	O	O	O	O				
	D1	O	-	O	-	-	-	O	-	-	-	O	O	O	O				
	D2	O	-	O	-	-	-	O	-	-	-	O	O	O	O				
	D3	O	-	O	-	-	-	O	-	-	-	O	O	O	O				

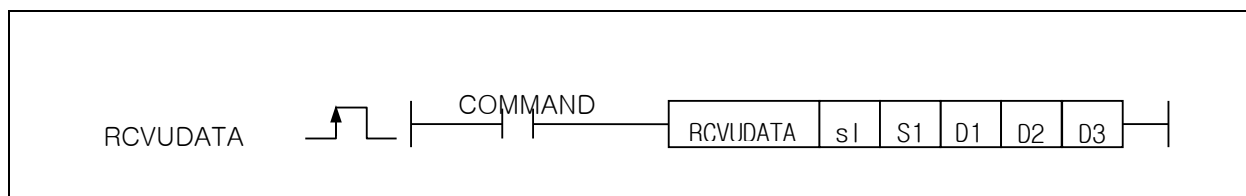

[Area Setting]

Operand	Description	Data type
sl	Base and slot number	WORD
S1	Channel (1 or 2)	WORD
D1	Data area to receive	WORD
D2	Data size to receive (maximum 1024 Byte)	WORD
D3	Temporary device that used in instruction	WORD

[Flag Setting]

Flag	Description	Device Number
Error	If sl value is not matched with CNET module installed.	F110

(a) RCVUDATA

- 1) RCVUDATA instruction receives user defined data(UDATA).
- 2) sl is base and slot number of CNET module installed.
- 3) S1 is channel number (1 or 2).
- 4) D1 is start device to save UDATA
- 5) D2 is size of UDATA and unit is Byte.
- 6) D3 is temporary device area to save instruction information. Initial value is 0 and If user change that value, instruction is not operated normally.

CPU Device	Data size	Information
D3	WORD	State code
D3+1	WORD	Reserved area (Prohibition on Use)
D3+2	WORD	
D3+3	WORD	

(b) Error

- 1) If sl value is not matched with CNET module installed, set error flag(F110).

(c) State Information

State code	State	Information
00	Initial state	Before excute instruction
01	Done	Instruction excute complete
02	Modlue setting error	If sl value is not matched with CNET module installed
03	Channel setting error	S1 value is not 1 or 2
04	No data received	No data received
05	Communication parameter setting error	If parameter of CNET module is not set as user defined data, or when Link enable is not set
06	Timeout error	No response casue of abnormal CNET module
07	Verseion mismatch	CNET OS version is below V3.2 (If CPU version is below V4.2, program download in not operated )

(d) Program Example

(e) 1) If Input signal M00001, Order to receive up to SIZE with CNET module attached to BASE, SLOT

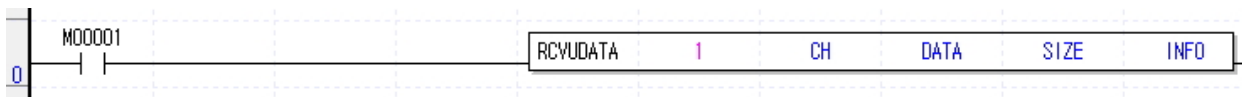

**Remark**

(1) Devices D3+1 ~ D3+3 set in operand D3 are the areas to be saved with instruction information. So users must not change that areas. If change that areas, instruction is not operated normally.

(2) Maximum size of data received is 1024 Byte and device number set as D2 must smaller than (end area of that device – 1024 Byte).

6.6.7 SENDDTR [MK]

Instruction	Area Available														Step	Flag			
	PMK	F	L	T	C	S	Z	D.x	R.x	Con st	U	N	D	R		Error (F110)	Zero (F111)	Carry (F112)	
SENDDTR	sl	-	-	-	-	-	-	0	-	-	0	-	-	-	-	4~7	0	-	-
	S1	0	-	0	-	-	-	0	-	-	0	0	0	0	0				
	S2	0	-	0	-	-	-	0	-	-	0	0	0	0	0				
	D	0	-	0	-	-	-	0	-	-	-	0	0	0	0				

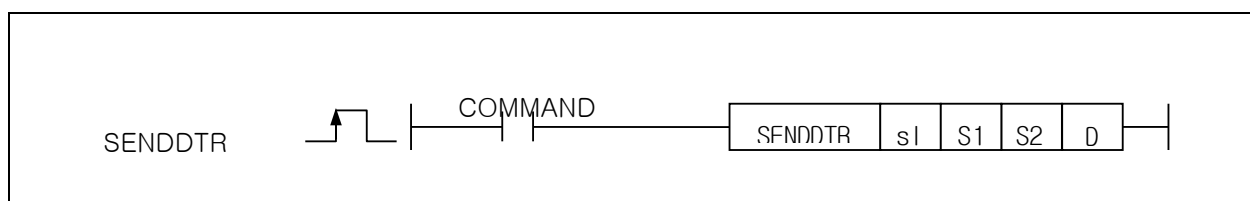

[Area Setting]

Operand	Description	Data type
sl	Base and slot number	WORD
S1	Channel (1 or 2)	WORD
S2	DTR (0 or 1)	WORD
D	Temporary device that used in instruction	WORD

[Flag Setting]

Flag	Description	Device Number
Error	If sl value is not matched with CNET module installed.	F110

(a) Function

- 1) SENDDTR instruction sends DTR(Data Terminal Ready) signal.
- 2) sl is base and slot number of CNET module installed.
- 3) S1 is channel number (1 or 2).
- 4) S2 is DTR value (0 or 1).
- 5) D is temporary device area to save instruction information. Initial value is 0 and If user change that value, instruction is not operated normally.

CPU Device	Data size	Information
D	WORD	State code
D+1	WORD	Reserved area (Prohibition on Use)
D+2	WORD	
D+3	WORD	

(b) Error

- 1) If sl value is not matched with CNET module installed, set error flag(F110).

(c) State Information



## Chapter 6 Server function and P2P service

State code	State	Information
00	Initial state	Before excute instruction
01	Done	Instruction excute complete
02	Modlue setting error	If sl value is not matched with CNET module installed
03	Channel setting error	S1 value is not 1 or 2
04	DTR level setting error	S2 DTR setting value is not 0 or 1
05	Communication parameter setting error	If parameter of CNET module is not set as user defined data, or when Link enable is not set
06	Timeout error	No response cause of abnormal CNET module
07	Verseion mismatch	CNET OS version is below V3.2 (If CPU version is below V4.2, program download in not operated )

(d) Program Example

- 1) If Input signal M00002, Order to send DTR(Data Terminal Ready) up to SIZE with CNET module attached to BASE, SLOT

(f)

(g)

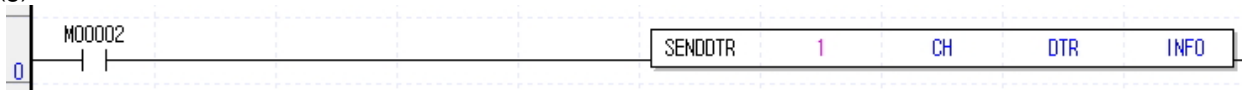

### Remark

(1) Devices D+1 ~ D+3 set in operand D are the areas to be saved with instruction information. So users must not change that areas. If change that areas, instruction is not operated normally.

6.6.8 SENDRTS [MK]

Instruction	Area Available														Step	Flag			
	PMK	F	L	T	C	S	Z	D.x	R.x	Con st	U	N	D	R		Error (F110)	Zero (F111)	Carry (F112)	
SNDDTR	sl	-	-	-	-	-	-	0	-	-	0	-	-	-	-	4~7	0	-	-
	S1	0	-	0	-	-	-	0	-	-	0	0	0	0	0				
	S2	0	-	0	-	-	-	0	-	-	0	0	0	0	0				
	D	0	-	0	-	-	-	0	-	-	-	0	0	0	0				

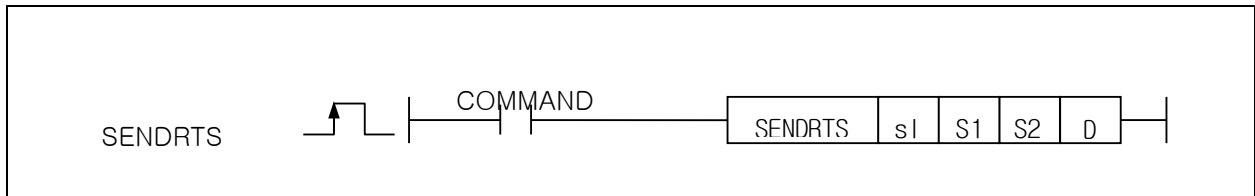

[Area Setting]

Operand	Description	Data type
sl	Base and slot number	WORD
S1	Channel (1 or 2)	WORD
S2	RTS (0 or 1)	WORD
D	Temporary device that used in instruction	WORD

[Flag Setting]

Flag	Description	Device Number
Error	If sl value is not matched with CNET module installed.	F110

(a) Function

- 1) SENDRTS instruction sends RTS(Request To Send) signal.
- 2) sl is base and slot number of CNET module installed.
- 3) S1 is channel number (1 or 2).
- 4) S2 is RTS value (0 or 1).
- 5) D is temporary device area to save instruction information. Initial value is 0 and If user change that value, instruction is not operated normally.

CPU Device	Data size	Information
D	WORD	State code
D+1	WORD	Reserved area (Prohibition on Use)
D+2	WORD	
D+3	WORD	

(b) Error

- 1) If sl value is not matched with CNET module installed, set error flag(F110).

(c) State Information

State code	State	Information
00	Initial state	Before excute instruction
01	Done	Instruction excute complete
02	Module setting error	If sl value is not matched with CNET module installed
03	Channel setting error	S1 value is not 1 or 2
04	DTR level setting error	S2 RTS setting value is not 0 or 1
05	Communication parameter setting error	If parameter of CNET module is not set as user defined data, or when Link enable is not set
06	Timeout error	No response casue of abnormal CNET module
07	Version mismatch	CNET OS version is below V3.2 (If CPU version is below V4.2, program download in not operated )

(d) Program Example

- 1) If Input signal M00003, Order to send RTS(Request to send) up to SIZE with CNET module attached to BASE, SLOT

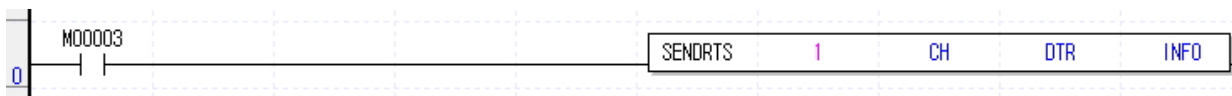

**Remark**

(1) Devices D+1 ~ D+3 set in operand D are the areas to be saved with instruction information. So users must not change that areas. If change that areas, instruction is not operated normally.

# Chapter 7 XGT Dedicated Protocol

## 7.1 XGT Dedicated Protocol

XGT series dedicated protocol communication is function executing communication by our dedicated protocol. User can configure the intended communication system between our products without special setting by using reading/writing data of internal device area and monitoring function.

Dedicated protocol function supported by XGB is as follows.

- Device individual/continuous read
- Device individual/continuous write
- Monitor variable registration
- Monitor execution
- 1:1 connection (Our link) system configuration

### Note

XGB's built-in communication function supports Cnet communication without any separate Cnet I/F module. It must be used under the following instructions.

- 1) Channel 0 of XGB's main unit supports 1:1 communication only. For 1:N system having master-slave Format, use RS-485 communication in channel 1 or XGB's main unit with XGL-C41A module connected. XGL-C41A module supports RS-422/485 protocol.
- 2) RS-232C communication cable for XGB's main unit is different from RS-232C cable for XG5000 in pin arrangement and from the cable for Cnet I/F module, too. The cable can't be used without any treatment. For the detailed wiring method, refer to configuration of respective communication.
- 3) It's possible to set baud rate type and station No. in XG5000.

### 7.1.1 Frame structure

(1) Base format

(a) Request frame (external communication device→XGB)

Header (ENQ)	Station number	Command	Command type	Structurized data area	Tail (EOT)	Frame check (BCC)
--------------	----------------	---------	--------------	------------------------	------------	-------------------

(b) ACK response frame (XGB→external communication device, when receiving data normally)

Header (ACK)	Station number	Command	Command type	Structurized data area or Null code	Tail (ETX)	Frame check (BCC)
--------------	----------------	---------	--------------	-------------------------------------	------------	-------------------

(c) NAK response frame (XGB→external communication device when receiving data abnormally)

Header (NAK)	Station number	Command	Command type	Error code ( ASCII 4 Byte )	Tail (ETX)	Frame check (BCC)
--------------	----------------	---------	--------------	-----------------------------	------------	-------------------

**Note**

- 1) The numerical data of all frames are ASCII codes equal to hexadecimal value, if there's no clear statement.  
The terms in hexadecimal are as follows.
  - Station No.
  - When the main command is R(r) or W (w) and the command type is numerical (means a data type)
  - All of the terms indicating size of all data in the formatted data area.
  - Monitoring registration and command registration number of execution commands.
  - All contents of data
- 2) If it is hexadecimal, H is attached in front of the number of frames like H01, H12345, H34, H12, and H89AB.
- 3) Available frame length is maximum 256 bytes.
- 4) Used control codes are as follows.

Codes	Hex value	Name	Contents
ENQ	H05	Enquire	Request frame initial code
ACK	H06	Acknowledge	ACK response frame initial code
NAK	H15	Not Acknowledge	NAK response frame initial code
EOT	H04	End of Text	Request frame ending ASCII code
ETX	H03	End Text	Response frame ending ASCII code

- 5) If the command is small letter (r), BCC value is added in check frame. The other side capital letter (R), BCC value is not added in check frame.

## Chapter 7 XGT Dedicated Protocol

### (2) Command frame sequence

- Sequence of command request frame

ENQ	Station No.	Command	Formatted data	EOT	BCC
-----	-------------	---------	----------------	-----	-----

ACK	Station No.	Command	Formatted data	ETX	BCC
-----	-------------	---------	----------------	-----	-----

(PLC ACK response)

NAK	Station No.	Command	Formatted data	ETX	BCC
-----	-------------	---------	----------------	-----	-----

(PLC NAK response)

### 7.1.2 List of commands

List of commands used in dedication communication is as shown below.

Classification Items		Command				Treatment
		Main command		Command type		
		Code	ASCII code	Code	ASCII code	
Reading device	Individual	r(R)	H72 (H52)	SS	5353	Reads direct variable of Bit, Byte, Word, Dword, Lword type.
	Continuous	r(R)	H72 (H52)	SB	5342	Read direct variable of Byte, Word, Dword, Lword with block unit (Bit continuous read is not allowed)
Writing device	Individual	w(W)	H77 (H57)	SS	5353	Write data of Bit, Byte, Word, Dword, Lword at direct variable
	Continuous	w(W)	H77 (H57)	SB	5342	Write data of Byte, Word, Dword, Lword at direct variable with block unit (Bit continuous read is not allowed)

Classification Item		Command			Treatment
		Main command		Register No	
		Code	ASCII code		
Monitoring variable register	x(X)	H78 (H58)	H00~H0F		Register device to monitor.
Execution of monitoring	y(Y)	H79 (H59)	H00~H0F		Execute registered device to monitor.

#### Note

- It identifies capitals or small letters for main commands, but not for the others.

### 7.1.3 Data type

It's possible to read and write device in built-in communication. When device is used, be aware of data type.

- Available types of device

- XBM-DXXXS and XBC-DXXXH

Device	"S" type range	"H" type range	Size (Word)	Remark
P	P0 – P127	P0 – P1023	1024	Read/Write/Monitor available
M	M0 – M255	M0 – M1023	1024	Read/Write/Monitor available
K	K0 – K2559	K0 – K4095	4096	Read/Write/Monitor available
F	F0 – F255	F0 – F1023	1024	Read/Monitor available
T	T0 – T255	T0 – T1023	1024	Read/Write/Monitor available
C	C0 – C255	C0 – C1023	1024	Read/Write/Monitor available
L	L0 – L1279	L0 – L2047	2048	Read/Write/Monitor available
N	N0 – N3935	N0 – N5119	5120	Read/Monitor available
D	D0 – D5119	D0 – D10239	10240	Read/Write/Monitor available
U	U00.00 – U07.31	U00.00 – U0A.31	352	Read/Write/Monitor available
Z	Z0 – Z127	Z0 – Z127	128	Read/Write/Monitor available
R	-	R0 – R10239	10240	Read/Write/Monitor available

- XEC-DXXXH

Device	Range	Size (Word)	Remark
I	%IW0.0.0 ~ %IW15.15.3	1024	Read/Write/Monitor available
Q	%QW0.0.0 ~ %QW15.15.3	1024	Read/Write/Monitor available
M	%MW0 ~ %MW8191	8192	Read/Write/Monitor available
W	%WW0 ~ %WW10239	10240	Read/Write/Monitor available
R	%RW0 ~ %RW10239	10240	Read/Write/Monitor available
F	%FW0 ~ %FW1023	1024	Read/Monitor available
K	%KW0 ~ %KW4095	4096	Read/Write/Monitor available
L	%LW0 ~ %LW2047	2048	Read/Write/Monitor available
N	%NW0 ~ %NW5119	5120	Read/Monitor available
U	%UW0.0.0 ~ %UW0.15.31	512	Read/Write/Monitor available

- When device is designated, attach '%' (25H) in front of the marking characters.  
( '%' is stands for starting of device.)

Data type	Marking characters	Examples
Bit	X(58H)	%PX000,%MX000,%LX000,%KX000,%CX000,%TX000,%FX000 etc.
Byte	B(42H)	%PB000,%MB000,%LB000,%KB000,%CB000,%TB000,%FB000 etc.
Word	W(57H)	%PW000,%MW000,%LW000,%KW000,%CW000,%TW000,%FW000, %DW000,%UW00.00 etc.
Dword	D(44H)	%PD000,%MD000,%LD000,%KD000,%CD000,%TD000, %FD000,%DD000 etc.
Lword	L(4CH)	%PL000,%ML000,%LL000,%KL000,%CL000,%TL000, %FL000,%DL000 etc.

### Note

- U device can be supported only when operating as a server.
- U device area input value
  - Bit: U01.02.3 → %UX343 ((1 x 32Word) + 2Word) + 3Bit), U07.09.4 → %UX2334 ((7 x 32Word) + 9Word)+ 4Bit)
  - Word: U03.07 → %UW103 ((3 x 32Word) + 7Word), U05.01 → %UW161 ((5 x 32Word) + 1Word)
- Timer/Counter used in bit command means contact point values.  
(word command means current values.)
- Data register (D) can uses only word or byte commands.
- In byte type commands, address is doubled. For example, D1234 is addressed to '%DW1234' in word type, and is addressed to '%DB2468' in byte type.



## 7.2 Detail of Instruction

### 7.2.1 Individual reading of device (R(r)SS)

This is a function that reads PLC device specified in accord with memory data type. Separate device memory can be read up to 16 at a time.

- PC request format

Format name	Header	Station No.	Command	Command type	Number of blocks	Device length	Device name	....	Tail	Frame check
Ex. of frame	ENQ	H20	R(r)	SS	H01	H06	%MW100		EOT	BCC
ASCII value	H05	H3230	H52(72)	H5353	H3031	H3036	H254D57313030		H04	

1 block (setting can be repeated up to max. 16 blocks)

Item	Description
BCC	When command is lowercase(r), only one lower byte of the value resulted by adding 1 Byte each to ASCII values from ENQ to EOT is converted into ASCII and added to BCC. For example, the BCC of the above frame is gotten as below: H05+H32+H30+H72+H53+H53+H30+H31+H30+H36+H25+H4D+H57+H31+H30+H30+H04 = H03A4 Therefore BCC value is A4 (ASCII value : H4134).
Number of Blocks	This specifies how much of the blocks composed of "[device length][device name]" are in this request format. This can be set up to 16. Therefore, the value of [Number of blocks] must be set between H01(ASCII value:3031)-H10(ASCII value:3030).
Device length (Length of device name)	This indicates the number of name's characters that means device, which is allowable up to 16 characters. This value is one of ASCII converted from hex type, and the range is from H01(ASCII value:3031) to H10(ASCII value:3130). For example, if the device name is %MW0, it has 4 characters to be H04 as its length. If %MW000 characters to be H06.
Device name	Address to be actually read is entered. This must be ASCII value within 16 characters, and in this name, digits, upper/lower case, '%' is only allowable to be entered.

#### Note

- BCC value is low 1byte in the sum of each byte from ENQ to EOT.
- In case of making actual frame, 'H' is not attached. Because the data of frame indicates hexadecimal.

- XGB response format (ACK response)

Format name	Header	Station No.	Command	Command type	Number of blocks	Number of data	data	.....	Tail	Frame check
Ex. of frame	ACK	H20	R(r)	SS	H01	H02	HA9F3		ETX	BCC
ASCII value	H06	H3230	H52(72)	H5353	H3031	H3032	H41394633		H04	

1 block (max. 16 blocks possible)

Item	Description												
BCC	When command is lowercase(r), only one lower byte of the value resulted by adding 1 Byte each to ASCII values from ACK to ETX is converted into ASCII and added to BCC, and sent.												
Number of data	<p>Number of data means byte number of hex type, and is converted into ASCII. This number is determined according to data type (X,B,W) included in device name of computer request Format.</p> <ul style="list-style-type: none"> <li>• Number of data in accordance with its data type is as follows:</li> </ul> <table border="1"> <thead> <tr> <th>Data type</th> <th>Available variable</th> <th>Number of data</th> </tr> </thead> <tbody> <tr> <td>Bit(X)</td> <td>%(P,M,L,K,F,T,C,D,R,I,Q,W)X</td> <td>1</td> </tr> <tr> <td>Byte(B)</td> <td>%(P,M,L,K,F,T,C,D,R,I,Q,W)B</td> <td>1</td> </tr> <tr> <td>Word(W)</td> <td>%(P,M,L,K,F,T,C,D,R,I,Q,W)W</td> <td>2</td> </tr> </tbody> </table> <p>※ R area is supported at XBC-DXXXH</p>	Data type	Available variable	Number of data	Bit(X)	%(P,M,L,K,F,T,C,D,R,I,Q,W)X	1	Byte(B)	%(P,M,L,K,F,T,C,D,R,I,Q,W)B	1	Word(W)	%(P,M,L,K,F,T,C,D,R,I,Q,W)W	2
Data type	Available variable	Number of data											
Bit(X)	%(P,M,L,K,F,T,C,D,R,I,Q,W)X	1											
Byte(B)	%(P,M,L,K,F,T,C,D,R,I,Q,W)B	1											
Word(W)	%(P,M,L,K,F,T,C,D,R,I,Q,W)W	2											
Data	<ul style="list-style-type: none"> <li>• In data area, there are the values of hex data converted to ASCII code saved.</li> </ul>												

- Example 1

The fact that number of data is H04 (ASCII code value:H3034) means that there is hex data of 4 bytes in data. Hex data of 4 bytes is converted into ASCII code in data.

- Example 2

If number of data is H04 and the data is H12345678, ASCII code converted value of this is "31 32 33 34 35 36 37 38," and this contents is entered in data area. Name directly, highest value is entered first, lowest value last.

- XGB response format (NAK response)

Format name	Header	Station No.	Command	Command type	Error code (Hex 2 Byte)	Tail	Frame check
Ex. of frame	NAK	H20	R(r)	SS	H1132	ETX	BCC
ASCII value	H15	H3230	H52(72)	H5353	H31313332	H03	

Item	Explanation
BCC	When command is lowercase(r), only one lower byte of the value resulted by adding 1 Byte each to ASCII values from NAK to ETX is converted into ASCII and added to BCC.
Error code	Hex and 2 bytes (ASCII code, 4 bytes) indicate error type. Refer to Appendix 3 error codes and countermeasures.

- Example

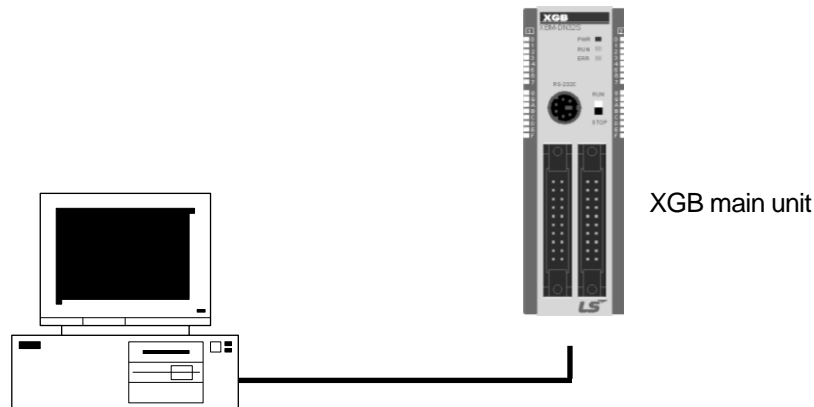

This example supposes when 1 WORD from M20 and 1 WORD from P001 address of station No.1 are read  
(At this time, it is supposed that H1234 is entered in M20, and data of H5678 is entered in P001.)

- PC request format (PC → XGB)

Format name	Header	Station No.	Command	Command type	Number of blocks	Variable length	Variable name	Device length	Variable name	Tail	Frame check
Ex. of frame	ENQ	H01	R(r)	SS	H02	H06	%MW020	H06	%PW001	EOT	BCC
ASCII value	H05	H3031	H52(72)	H5353	H3032	H3036	H254D57303230	H3036	H25505730303031	H04	

- For ACK response after execution of command (PC ← XGB)

Format name	Header	Station No.	Command	Command type	Number of blocks	Number of data	Data	Number of data	Data	Tail	Frame check
Ex. of frame	ACK	H01	R(r)	SS	H02	H02	H1234	H02	H5678	ETX	BCC
ASCII value	H06	H3031	H52(72)	H5353	H3032	H3032	H31323334	H3032	H35363738	H03	

- For NAK response after execution of command (PC ← XGB)

Format name	Header	Station No.	Command	Command type	Error code	Tail	Frame check
Ex. of frame	NAK	H01	R(r)	SS	Error code (2 Byte)	ETX	BCC
ASCII value	H15	H3031	H52(72)	H5353	Error code (4 Byte)	H03	

## 7.2.2 Direct variable continuous reading (R(r)SB)

This is a function that reads the PLC device memory directly specified in accord with memory data type. With this, data is read from specified address as much as specified continuously.

- PC request format

Format name	Header	Station No.	Command	Command type	Device length	Device	Number of data	Tail	Frame check
Ex. of frame	ENQ	H10	R(r)	SB	H06	%MW100	H05	EOT	BCC
ASCII value	H05	H3130	H52(72)	H5342	H3036	H254D5731 3030	H3035	H04	

Item	Description
BCC	When command is lowercase(r), only one lower byte of the value resulted by adding 1 Byte each to ASCII values from ENQ to EOT is converted into ASCII and added to BCC.
Device length (Length of device name)	This indicates the number of name's characters that means device, which is allowable up to 16 characters. This value is one of ASCII converted from hex type, and the range is from H01 (ASCII value:3031) to H10 (ASCII value:3130).
Device name	Address to be actually read is entered. This must be ASCII value within 16 characters, and in this name, digits, upper/lowercase, and '%' only are allowable to be entered.

### Note

- Number of data specifies the number to read according to the type of data. Namely, if the data type of device is word and number is 5, it means that 5 words should be read.
- In the number of data, you can use up to 60 words (120Byte).
- Protocol of continuous reading of direct variable doesn't have number of blocks.
- Bit device continuous reading is not supported.

- XGB response format (ACK response)

Format name	Header	Station No.	Command	Command type	Number of blocks	Number of data	data	Tail	Frame check
Ex. of frame	ACK	H10	R(r)	SB	H01	H02	H1122	ETX	BCC
ASCII value	H06	H3130	H52(72)	H5342	H3031	H3134	H31313232	H03	

Item	Description															
Number of data	It means byte number of hex type, and is converted into ASCII															
	<table border="1" style="width: 100%;"> <thead> <tr> <th>Data type</th> <th>Available device</th> <th>Data size (Byte)</th> </tr> </thead> <tbody> <tr> <td>BYTE(B)</td> <td>%(P,M,L,K,F,T,C,D,R,I,Q,W)B</td> <td>1</td> </tr> <tr> <td>WORD(W)</td> <td>%(P,M,L,K,F,T,C,D,R,I,Q,W)W</td> <td>2</td> </tr> <tr> <td>DWord(D)</td> <td>%(P,M,L,K,F,T,C,D,R,I,Q,W)D</td> <td>4</td> </tr> <tr> <td>LWord(L)</td> <td>%(P,M,L,K,F,T,C,D,I,Q,W)L</td> <td>8</td> </tr> </tbody> </table>	Data type	Available device	Data size (Byte)	BYTE(B)	%(P,M,L,K,F,T,C,D,R,I,Q,W)B	1	WORD(W)	%(P,M,L,K,F,T,C,D,R,I,Q,W)W	2	DWord(D)	%(P,M,L,K,F,T,C,D,R,I,Q,W)D	4	LWord(L)	%(P,M,L,K,F,T,C,D,I,Q,W)L	8
	Data type	Available device	Data size (Byte)													
	BYTE(B)	%(P,M,L,K,F,T,C,D,R,I,Q,W)B	1													
	WORD(W)	%(P,M,L,K,F,T,C,D,R,I,Q,W)W	2													
	DWord(D)	%(P,M,L,K,F,T,C,D,R,I,Q,W)D	4													
LWord(L)	%(P,M,L,K,F,T,C,D,I,Q,W)L	8														
※R area is supported at XBC-DXXXH																

- Example 1

When memory type included in variable name of computer request Format is W (Word), and data number of computer request Format is 03, data number of PLC ACK response after execution of command is indicated by H06 (2\*03 = 06 bytes)Byte and ASCII code value 3036 is entered in data area.

- Example 2

In just above example, when data contents of 3 words are 1234, 5678, and 9ABC in order, actual ASCII code converted values are 31323334 35363738 39414243, and the contents are entered in data area.

- XGB response format (NAK response)

Format name	Header	Station No.	Command	Command type	Error code (Hex 2 Byte)	Tail	Frame check
Ex. of frame	NAK	H10	R(r)	SB	H1132	ETX	BCC
ASCII value	H15	H3130	H52(72)	H5342	H31313332	H03	

Item	Description
BCC	When command is lowercase(r), only one lower byte of the value resulted by adding 1 Byte each to ASCII values from NAK to ETX is converted into ASCII and added to BCC, and sent.
Error code	Hex and 2 bytes (ASCII code, 4 bytes) indicate error type. For the details, Refer to Appendix 3 error codes and countermeasures.

## Chapter 7 XGT Dedicated Protocol

- Example

This example supposes that 2 WORDs from M000 of station No. 10 is read  
(It supposes that M000 = H1234, M001 = H5678.)

- PC request format (PC → XGB)

Format name	Header	Station No.	Command	Command type	Device length	Device name	Number of data	Tail	Frame check
Frame (Example)	ENQ	H0A	R(r)	SB	H06	%MW000	H02	EOT	BCC
ASCII value	H05	H3041	H52(72)	H5342	H3036	H254D303030	H3032	H04	

- For ACK response after execution of command (PC ← XGB)

Format name	Header	Station No.	Command	Command type	Number of block	Number of data	Data	Tail	Frame check
Frame (Example)	ACK	H0A	R(r)	SB	H01	H04	12345678	ETX	BCC
ASCII value	H06	H3041	H52(72)	H5342	H3031	H3034	H3132333435363738	03	

- For NAK response after execution of command (PC ← XGB)

Format name	Header	Station No.	Command	Command type	Error code	Tail	BCC
Frame (Example)	NAK	H0A	R(r)	SB	Error code (2 Byte)	ETX	BCC
ASCII value	H15	H3041	H52(72)	H5342	Error code (4 Byte)	H03	

### 7.2.3 Individual writing of device (W(w)SS)

This is a function that writes the PLC device memory directly specified in accord with memory data type.

- PC request format

Format name	Header	Station No.	Command	Command type	Number of blocks	Device Length	Device Name	Data	.....	Tail	Frame check
Frame (Example)	ENQ	H20	W(w)	SS	H01	H06	%MW100	H00E2		EOT	BCC
ASCII value	H05	H3230	H57(77)	H5353	H3031	H3036	H254D57313030	H30304532		H04	

1 block (setting can be repeated up to max. 16 blocks)

Item	Description
BCC	When command is lowercase(r), only one lower byte of the value resulted by adding 1 Byte each to ASCII values from ENQ to EOT is converted into ASCII and added to BCC.
Number of blocks	This specifies how much of the blocks composed of "[device length][device name]" are in this request Format. This can be set up to 16. Therefore, the value of [Number of blocks] must be set between H01(ASCII value:3031)-H10 (ASCII value:3030).
Device Length (Name length of device)	This indicates the number of name's characters that means device, which is allowable up to 16 characters. This value is one of ASCII converted from hex type, and the range is from H01 (ASCII value: 3031) to H10 (ASCII value:3130).
device	Address to be actually read is entered. This must be ASCII value within 16 characters, and in this name, digits, upper/lower case, and '%' only is allowable to be entered.
Data	If the value to be written in %MW100 area is H A, the data Format must be H000A. If the value to be written in %MW100 area is H A, the data Format must be H000A. In data area, the ASCII value converted from hex data is entered.

- Example 1

If type of data to be currently written is WORD, the data is H1234, ASCII code converted value of this is "31323334" and this content must be entered in data area. Namely, most significant value must be sent first, least significant value last.

**Note**

- Device data types of each block must be the same
- If data type is Bit, the data to be written is indicated by bytes of hex. Namely, if Bit value is 0, it must be indicated by H00 (3030), and if 1, by H01 (3031).

- XGB Response format (ACK response)

Format name	Header	Station No.	Command	Command type	Tail	Frame check
Frame (Example)	ACK	H20	W(w)	SS	ETX	BCC
ASCII value	H06	H3230	H57(77)	H5353	H03	

Item	Description
BCC	When command is lowercase (r), only one lower byte of the value resulted by adding 1 Byte each to ASCII values from ACK to ETX is converted into ASCII and added to BCC, and sent.

- XGB Response format (NAK response)

Format name	Header	Station No.	Command	Command type	Error code (Hex 2 Byte)	Tail	Frame check
Frame (Example)	NAK	H20	W(w)	SS	H4252	ETX	BCC
ASCII value	H15	H3230	H57(77)	H5353	H34323532	H03	

Item	Description
BCC	When command is lowercase(r), only one lower byte of the value resulted by adding 1 Byte each to ASCII values from NAK to ETX is converted into ASCII and added to BCC, and sent.
Error code	Hex and 2 bytes (ASCII code, 4 bytes) indicate error type. For the details, Refer to Appendix 3 error codes and countermeasures.

- Example

This example supposes that "HFF" is written in M230 of station No. 1.

- PC request format (PC → XGB)

Format name	Header	Station No.	Command	Command type	Number of blocks	Device Length	Device Name	Data	Tail	Frame check
Frame (Example)	ENQ	H01	W(w)	SS	H01	H06	%MW230	H00FF	EOT	BCC
ASCII value	H05	H3031	H57(77)	H5353	H3031	H3036	H254D573233 30	H30304646	H04	

- For ACK response after execution of command (PC ← XGB)

Format name	Header	Station No.	Command	Command type	Tail	Frame check
Frame (Example)	ACK	H01	W(w)	SS	ETX	BCC
ASCII value	H06	H3031	H57(77)	H5353	H03	

- For NAK response after execution of command (PC ← XGB)

Format name	Header	Station No.	Command	Command type	Error code	Tail	Frame check
Frame (Example)	NAK	H01	W(w)	SS	Error code (2 Byte)	ETX	BCC
ASCII value	H15	H3031	H57(77)	H5353	Error code (4 Byte)	H03	



### 7.2.4 Continuous writing of device (W(w)SB)

This is a function that directly specifies PLC device memory and continuously writes data from specified address as much as specified length.

- Request format

Format name	Header	Station No.	Command	Command type	Device Length	Device name	Number of data	Data	Tail	Frame check
Frame (Example)	ENQ	H10	W(w)	SB	H06	%MW100	H02	H11112222	EOT	BCC
ASCII value	H05	H3130	H57(77)	H5342	H3036	H254D57313030	H3032	H3131313132323232	H04	

Item	Description
BCC	When command is lowercase(r), only one lower byte of the value resulted by adding 1 Byte each to ASCII values from ENQ to EOT is converted into ASCII and added to BCC.
Device Length (Name length of variable)	This indicates the number of name's characters that means device, which is allowable up to 16 characters. This value is one of ASCII converted from hex type, and the range is from H01 (ASCII value: 3031) to H10 (ASCII value: 3130).
Device	Address to be actually read. This must be ASCII value within 16 characters, and in this name, digits, upper/lower case, and '%' only are allowable to be entered.

**Note**

- Number of data specifies the number according to the type of device. Namely, if the data type of device is WORD, and number of data is 5, it means that 5 WORDs should be written.
- Number of data can be used up to 120Bytes (60 Words).

- XGB Response format (ACK response)

Format name	Header	Station No.	Command	Command type	Tail	Frame check
Frame (Example)	ACK	H10	W(w)	SB	ETX	BCC
ASCII value	H06	H3130	H57(77)	H5342	H03	

Item	Description
BCC	When command is lowercase(r), only one lower byte of the value resulted by adding 1 Byte each to ASCII values from ACK to ETX is converted into ASCII and added to BCC, and sent.

- XGB Response format (NAK response)

Format name	Header	Station No.	Command	Command type	Error code (Hex 2 Byte)	Tail	Frame check
Frame (Example)	ENQ	H10	W(w)	SB	H1132	EOT	BCC
ASCII value	H05	H3130	H57(77)	H5342	H31313332	H03	

Item	Description
BCC	When command is lowercase(r), only one lower byte of the value resulted by adding 1 Byte each to ASCII values from NAK to ETX is converted into ASCII and added to BCC, and sent.
Error code	Hex and 2 bytes (ASCII code, 4 bytes) indicate error type. For the details, Refer to Appendix 3 error codes and countermeasures.

- Example

This example supposes that 2 byte H'AA15 is written in D000 of station No. 1.

- PC request format (PC → XGB)

Format name	Header	Station No.	Command	Command type	Device Length	Device	Number of data	Data	Tail	Frame check
Frame (Example)	ENQ	H01	W(w)	SB	H06	%DW000	H01	HAA15	EOT	BCC
ASCII value	H05	H3031	H57(77)	H5342	H3036	H254457303030	H3031	H41413135	H04	

- For ACK response after execution of command (PC ← XGB)

Format name	Header	Station No.	Command	Command type	Tail	Frame check
Frame (Example)	ACK	H01	W(w)	SB	ETX	BCC
ASCII value	H06	H3031	H57(77)	H5342	H03	

- For NAK response after execution of command (PC ← XGB)

Format name	Header	Station No.	Command	Command type	Error code	Tail	Frame check
Frame (Example)	NAK	01	W(w)	SB	Error code (2)	ETX	BCC
ASCII value	H15	H3031	H57(77)	H5342	Error code (4)	H03	

### 7.2.5 Monitor variable register (X##)

Monitor register can separately register up to 16 (from 0 to 15) in combination with actual variable reading command, and carries out the registered one through monitor command after registration.

- PC request format

Format name	Header	Station No.	Command	Registration No.	Registration format	Tail	Frame check
Frame (Example)	ENQ	H10	X(x)	H09	Refer to registration format	EOT	BCC
ASCII value	H05	H3130	H58(78)	H3039	Refer to *1	H04	

Item	Description
BCC	When command is lowercase(x), only one lower byte of the value resulted by adding 1 byte each to ASCII values from ENQ to EOT is converted into ASCII, added to BCC.
Register No.	This can be registered up to 16 (0 to 15, H00-H0F), and if an already registered No. is registered again, the one currently being executed is registered.
Register Format	This is used to before EOT in command of Formats of separate reading of variable, continuous reading, and named variable reading.

**Note**  
\*1 : Register Format of request Formats must select and use only one of the followings.

- 1) Individual reading of device

RSS	Number of blocks (2 Byte)	Device length (2 Byte)	Device name (16 Byte)	...
	1 block (max. 16 blocks)			

- 2) Continuous reading of device

RSB	Device length (2 Byte)	Device name (16 Byte)	Number of data
-----	------------------------	-----------------------	----------------

- XGB Response format (ACK response)

Format name	Header	Station No.	Command	Registration no.	Tail	Frame check
Frame (Example)	ACK	H10	X(x)	H09	ETX	BCC
ASCII value	H06	H3130	H58(78)	H3039	H03	

Item	Description
BCC	When command is lowercase(x), only one lower byte of the value resulted by adding 1 Byte each to ASCII values from ACK to ETX is converted into ASCII and added to BCC, and sent.

- XGB Response format (NAK response)

Format name	Header	Station No.	Command	Registration No.	Error code (Hex 2Byte)	Tail	Frame check
Frame (Example)	NAK	H10	X(x)	H09	H1132	ETX	BCC
ASCII value	H15	H3130	H58(78)	H3039	H31313332	H03	

Item	Description
BCC	When command is one of lower case(x), only one lower byte of the value resulted by adding 1 Byte each to ASCII values from NAK to ETX is converted into ASCII and added to BCC, and sent.
Error code	Hex and 2 bytes (ASCII code, 4 bytes) indicate error type. For the details, Refer to Appendix 3 error codes and countermeasures.

- Example

This example supposes that device M000 of station NO. 1 is monitor registered.

- PC request format (PC → XGB)

Format name	Header	Station No.	Command	Registration No.	Registration Format				Tail	Frame check
					R##	Number of blocks	Device length	Device name		
Frame (Example)	ENQ	H01	X(x)	H01	RSS	H01	H06	%MW000	EOT	BCC
ASCII value	H05	H3031	H58(78)	H3031	H525353	H3031	H3036	H255457303030	H04	

- For ACK response after execution of command (PC ← XGB)

Format name	Header	Station No.	Command	Registration No.	Tail	Frame check
Frame (Example)	ACK	H01	X(x)	H01	ETX	BCC
ASCII value	H06	H3031	H58(78)	H3031	H03	

- For NAK response after execution of command (PC ← XGB)

Format name	Header	Station No.	Command	Registration No.	Error code	Tail	Frame check
Frame (Example)	NAK	H01	X(x)	H01	Error code (2)	ETX	BCC
ASCII value	H15	H3031	H58(78)	H3031	Error code (4)	H03	

### 7.2.6 Monitor execution (Y##)

This is a function that carries out the reading of the variable registered by monitor register. This also specifies a registered number and carries out reading of the variable registered by the number.

- PC request format

Format name	Header	Station No.	Command	Registration No.	Tail	Frame check
Frame (Example)	ENQ	H10	Y(y)	H09	EOT	BCC
ASCII value	H05	H3130	H59(79)	H3039	H03	

Item	Description
Register No.	Register No. uses the same number registered during monitor register for monitor execution. It is possible to set from 00-09 (H00-H09).
BCC	When command is lower case(y), only one lower byte of the value resulted by adding 1 byte each to ASCII values from ENQ to EOT is converted into ASCII, added to BCC.

- XGB Response format (ACK response)

1) In case that the register Format of register No. is the Individual reading of device

Format name	Header	Station No.	Command	Registration No.	Number of Blocks	Number of data	Data	Tail	Frame check
Frame (Example)	ACK	H10	Y(y)	H09	H01	H02	H9183	ETX	BCC
ASCII値	H06	H3130	H59(79)	H3039	H3031	H3032	H39313833	H03	

2) In case that the register Format of register No. is the continuous reading of device

Format name	Header	Station No.	Command	Registration No.	Number of data	Data	Tail	Frame check
Frame (Example)	ACK	H10	Y(y)	H09	H04	H9183AABB	ETX	BCC
ASCII value	H06	H3130	H59(79)	H3039	H3034	H3931383341414242	H03	

- XGB Response Format (NAK response)

Format name	Header	Station No.	Command	Registration No.	Error code (Hex 2Byte)	Tail	Frame check
Frame (Example)	NAK	H10	Y(y)	H09	H1132	ETX	BCC
ASCII value	H15	H3130	H59(79)	H3039	H31313332	H03	

Item	Description
BCC	When command is lowercase(y), only one lower byte of the value resulted by adding 1 Byte each to ASCII values from NAK to ETX is converted into ASCII and added to BCC, and sent.
Error code	Hex and 2 bytes (ASCII code, 4 bytes) indicate error type. For the details, Refer to Appendix 3 error codes and countermeasures.

- Example

This example supposes that registered device No. 1 of station No. 1 is read, and BCC value is checked. And it is supposed that device M000 is registered and the number of blocks is 1.

- PC request format (PC → XGB)

Format name	Header	Station No.	Command	Registration No.	Tail	Frame check
Frame (Example)	ENQ	H01	Y(y)	H01	EOT	BCC
ASCII value	H05	H3031	H59(79)	H3031	H04	

- For ACK response after execution of command (PC → XGB)

Format name	Header	Station No.	Command	Registration No.	Number of Blocks	Number of data	Data	Tail	Frame check
Frame (Example)	ACK	H01	Y(y)	H01	H01	H02	H2342	ETX	BCC
ASCII value	H06	H3031	H59(79)	H3031	H3031	H3032	H32333432	H03	

- For NAK response after execution of command (PC → XGB)

Format name	Header	Station No.	Command	Registration No.	Error code	Tail	Frame check
Frame (Example)	NAK	H01	Y(y)	H01	Error code(2)	ETX	BCC
ASCII value	H15	H3031	H59(79)	H3031	Error code(4)	H03	

# Chapter 8 LS Bus Protocol

## 8.1 LS Bus Protocol

LS Bus Protocol communication is function executing communication between XGB Cnet and LS Inverter. User can configure LS Bus communication system between our products without special setting by using reading/writing data of internal device area and monitoring function.

The function of LS Bus Protocol supported by XGB is as follows.

- ◆ Device continuous reading
- ◆ Device continuous writing

### 8.1.1 Frame structure

1) Base format

(a) Request frame (External communication → XGB)

Header (ENQ)	Station number	Command	Structurized data area	Frame check (BCC)	Tail (EOT)
--------------	----------------	---------	------------------------	-------------------	------------

(b) ACK response frame (XGB → External communication, when receiving data normally)

Header (ACK)	Station number	Command	Structurized data area	Frame check (BCC)	Tail (EOT)
--------------	----------------	---------	------------------------	-------------------	------------

(c) NAK response frame (XGB → External communication, when receiving data abnormally)

Header (NAK)	Station number	Command	Error code ( ASCII 4 Byte )	Frame check (BCC)	Tail (EOT)
--------------	----------------	---------	-----------------------------	-------------------	------------

#### Note

- 1) The numerical data of all frames are ASCII codes equal to hexadecimal value, if there's no clear statement. The terms in hexadecimal are as follows.
  - Station No.
  - Command type is supported R (read) and W (write).
  - All contents of data
- 2) If it is hexadecimal, H is attached in front of the number of frames like H01, H12345, H34, H12, and H89AB.
- 3) Available frame length is maximum 256 bytes.
- 4) Used control codes are as follows.

Code	Hex value	Name	Contents
ENQ	H05	Enquire	Request frame initial code
ACK	H06	Acknowledge	ACK response frame initial code
NAK	H15	Not Acknowledge	NAK response frame initial code
EOT	H04	End of Text	Request frame ending ASCII code

2) Command frame sequence

- Sequence of command request frame

ENQ	Station No.	Command	Formatted data	BCC	EOT
-----	-------------	---------	----------------	-----	-----

ACK	Station No.	Command	Formatted data	BCC	EOT
-----	-------------	---------	----------------	-----	-----

(Inverter ACK response)

NAK	Station No.	Command	Formatted data	BCC	EOT
-----	-------------	---------	----------------	-----	-----

(Inverter NAK response)

8.1.2 List of commands

List of commands used in LS Bus communication is as shown below.

Classification Items	Command		Treatment
	Command type		
	Code	ASCII code	
Continuous read	R	H52	Read inverter variable of Word.
Continuous write	W	H57	Write inverter variable of Word.



## 8.2 Detail of instruction

### 8.2.1 Continuous writing to inverter device (W)

This command is to write PLC data in specified address of inverter.

- LS Bus Client Request format

Format name	Header	Station No.	Command	Device Length	Address of inverter	Data	.....	Frame check	Tail
Frame (Example)	ENQ	H20	W	H6	0100	H00E2	-	BCC	EOT
ASCII value	H05	H3230	H57	H36	H30313030	H30304532	-	-	H04

Item	Description
BCC	When ASCII value of each 1byte except ENQ and EOT is summed, the lowest 1byte of the result value is BCC.
Device Length	This specifies how many Words you will write. As converted value to ASCII, the range is from H01 (ASCII value: 3031) to H08 (ASCII value: 3038).
Address of inverter	Enter the address that you want to read. ASCII value above 4 characters and non-numeric is not allowed.
Data	When you write data H'A to inverter address 0100 area, the data format has to be H000A.

- Example)

If you want to write H1234, 31323334 (Converted value to ASCII) should be included in the data area. So, the highest value has to be sent first and the lowest value has to be sent last.

#### Note

- Device data of Word type is only supported.

● Inverter Response format(ACK response)

Format name	Header	Station No.	Command	Data		Frame check	Tail
Frame (Example)	ACK	H20	W	H00E2	...	BCC	EOT
ASCII value	H06	H3230	H57	H30304532	-	-	H04

Item	Description
BCC	When ASCII value of each 1byte except ENQ and EOT is summed, the lowest 1byte of the result value is BCC.

● Inverter Response format(NAK response)

Format name	Header	Station No.	Command	Error code (ASC 2 Byte)	Frame check	Tail
Frame (Example)	NAK	H20	W	H12	BCC	EOT
ASCII value	H15	H3230	H57	H3132	-	H04

Item	Description
BCC	When ASCII value of each 1byte except ENQ and EOT is summed, the lowest 1byte of the result value is BCC.
Error code	Error information is shown as hex 1byte (2bytes of ASCII code). For more information, please refer to the error code of the inverter user manual.

● Example

This describes if the user want to write "H00FF" to address number 1230 of station number 1 of inverter.

● XGB request format (XGB → Inverter)

Format name	Header	Station No.	Command	Device length	Address of inverter	Data	Frame check	Tail
Frame (Example)	ENQ	H01	W	H1	1230	H00FF	BCC	EOT
ASCII value	H05	H3031	H57	H3031	H31323330	H30304646	-	H04

● For ACK response after execution of command (XGB ← Inverter)

Format name	Header	Station No.	Command	Data	Frame check	Tail
Frame (Example)	ACK	H01	W	H00FF	BCC	EOT
ASCII value	H06	H3031	H57	H30304646	-	H04

● For NAK response after execution of command (XGB ← Inverter)

Format name	Header	Station No.	Command	Error code	Frame check	Tail
Frame (Example)	NAK	H01	W	H12	BCC	EOT
ASCII value	H15	H3031	H57	Error code (2 Byte)	-	H04

### 8.2.2 Inverter continuous reading (R)

This is a function of continuous reading of designated amount of PLC data from designated address number.

- PC Request format

Format name	Header	Station No.	Command	Address of inverter	Number of data	Frame check	Tail
Frame (Example)	ENQ	H10	R	0100	H5	BCC	EOT
ASCII value	H05	H3130	H52	H30313030	H35	-	H04

Item	Description
BCC	When ASCII value of each 1byte except ENQ and EOT is summed, the lowest 1byte of the result value is BCC.
Device length	This specifies how many Words you will write. As converted value to ASCII, the range is from H01 (ASCII value: 3031) to H08 (ASCII value: 3038).
Address of inverter	Enter the address that you want to read. ASCII value above 4 characters and non-numeric is not allowed.

#### Note

- Device data of Word type is only supported.

● Inverter response format (ACK response)

Format name	Header	Station No.	Command	Data		Frame check	Tail
Frame (Example)	ACK	H20	R	H00E2	...	BCC	EOT
ASCII value	H06	H3230	H52	H30304532	-	-	H04

Item	Description
BCC	When ASCII value of each 1byte except ENQ and EOT is summed, the lowest 1byte of the result value is BCC.

● Inverter response format (NAK response)

Format name	Header	Station No.	Command	Error code (ASC 2 Byte)	Frame check	Tail
Frame (Example)	NAK	H20	R	H12	BCC	EOT
ASCII value	H15	H3230	H52	H3132	-	H04

Item	Description
BCC	When ASCII value of each 1byte except ENQ and EOT is summed, the lowest 1byte of the result value is BCC.
Error code	Error information is shown as hex 1byte (2bytes of ASCII code). For more information, please refer to the error code of the inverter user manual.

● Example

This describes if the user want to read 1Word data from address number 1230 of station number 1 of inverter.

● XGB request format (XGB → Inverter)

Format name	Header	Station No.	Command	Address of inverter	Device length	Frame check	Tail
Frame (Example)	ENQ	H01	R	1230	H1	BCC	EOT
ASCII value	H05	H3031	H52	H31323330	H31	-	H04

● For ACK response after execution of command (XGB ← Inverter)

Format name	Header	Station No.	Command	Data	Frame check	Tail
Frame (Example)	ACK	H01	R	H1234	BCC	EOT
ASCII value	H06	H3031	H52	H31323334	-	H04

● For NAK response after execution of command (XGB ← Inverter)

Format name	Header	Station No.	Command	Error code	Frame check	Tail
Frame (Example)	NAK	H01	R	H12	BCC	EOT
ASCII value	H15	H3031	H52	H3132	-	H04

# Chapter 9 Modbus Communication

## 9.1 General

Modbus protocol is specified open protocol used between client-server, which executes reading/writing data according to function code. Communication between devices that use Modbus protocol uses Client-server function in which only one client processes the data.

## 9.2 Modbus Protocol

### 9.2.1 Kind of modbus protocol

There are two communication modes of Modbus, ASCII and RTU.

Characteristic		ASCII mode	RTU mode
Coding method		ASCII code	8 bit binary code
No. of data per one character	Start bit	1	1
	Data bit	7	8
	Parity bit	Even,Odd,None	Even,Odd,None
	Stop bit	1 or 2	1 or 2
Error check		LRC(Longitudinal Redundancy Check)	CRC (Cyclical Redundancy Check)
Start of frame		Colon (:)	3.5 Character no response time

### 9.2.2 Structure of modbus protocol

Modbus protocol' s structure is as follows.

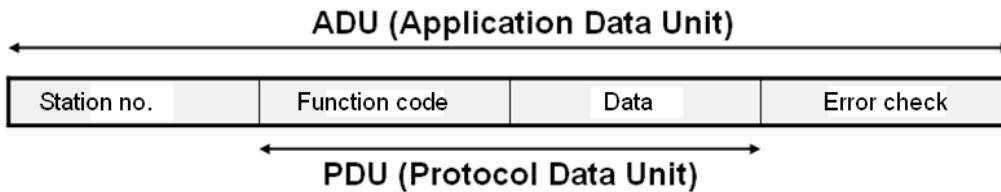

In case of normal communication, process step is as follows.

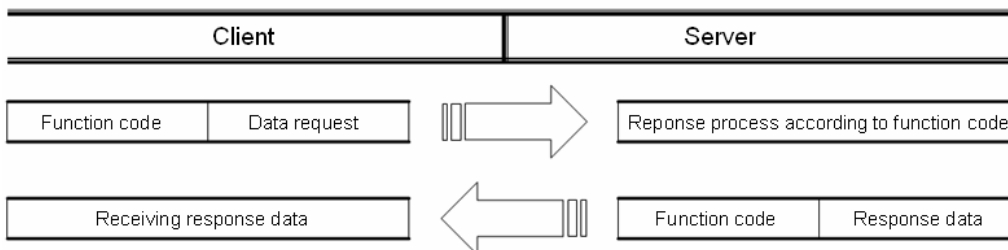

In case of abnormal communication, process step is as follows.

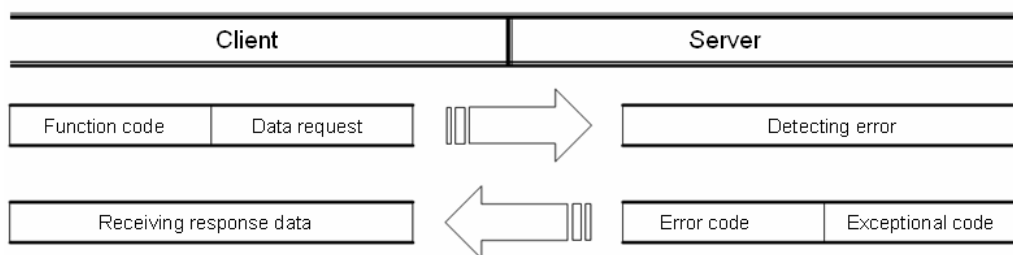

When receiving the abnormal frame from client, server transmits error code and exceptional code. Error code is function code adding 80(Hex) and exceptional code indicate the specific error content. Each code has following content.

Code	Code name	Meaning
01	Function code error	Function code error
02	Address error	Exceeds allowed address range
03	Data setting error	Not allowed data value
04	Server error	Server(slave) is error
05	Server requesting re-transmission	Now server is too busy to process and requests re-transmission later
06	Server process time delay	Server takes time to process. Master should request again.

### 9.3 Structure of Frame

#### 9.3.1 Structure of frame in the ASCII mode

Frame structure in the ASCII mode is as follows.

Classification	Start	Station no.	Function code	Data	Error check	End
Size (byte)	1	2	2	N	2	2

##### (1) Characteristic of ASCII mode

- (a) In the ASCII mode, start of frame is indicated with colon (:), which is ASCII code, and end of frame is indicated with 'CRLF'.
- (b) Each character allows maximum 1s interval.
- (c) How to check the error uses LRC, it takes 2's complement except frame of start and end and converts it as ASCII conversion.

##### (2) Address area

- (a) It consists of 2 byte.
- (b) When using the XGT Cnet I/F module, range of station is 0~31.
- (c) Station number 0 is used for client.
- (d) When server responds, it contains self address to response frame to know client's response.

##### (3) Data area

- (a) Transmits the data by using the ASCII data, data structure changes according to function code.
- (b) In case of receiving normal frame, it responds as normal response.
- (c) In case of receiving abnormal frame, it responds by using error code.

##### (4) Error check area

How to check error of frame takes 2' s complement except start and end of frame and converts it as ASCII.

### 9.3.2 Frame structure in the RTU mode

Frame structure in the RTU mode is as follows.

Classification	Start	Station number	Function code	Data	Error check	End
size(byte)	Idle time	1	1	N	2	Idle time

#### (1) Characteristic of RTU mode

- (a) It uses hexadecimal.
- (b) Start character is station number and frame is classified by CRC error check.
- (c) Start and end of frame is classified by adding idle time of 1 bit.
- (d) Between frames, there is interval of 3.5 character time. When exceeding 1.5 character time, it is acknowledged as independent frame.

#### (2) Address area

- (a) It consists of 1 byte.
- (b) When using the XGT Cnet I/F module, range of station is 0~31.
- (c) Station number 0 is used for client.
- (d) When server responds, it contains self address to response frame to know client's response.

#### (3) Data area

- (a) Transmits the data by using the Hex. data, data structure changes according to function code.
- (b) In case of receiving normal frame, it responds as normal response.
- (c) In case of receiving abnormal frame, it responds by using error code.

#### (4) Error check area

It determines if frame is normal or not by using CRC check of 2 byte.

#### (5) Modbus address regulation

Address in the data starts from 0 and it is same with value that is minus 1 from modbus memory, Modbus address 2 is same with address 1 of data.



### 9.3.3 Data and expression of address

To express data and address of modbus protocol, the characteristic is as follows.

- (1) It used hexadecimal as basic form.
- (2) In the ASCII mode, Hex data is converted into ASCII code.
- (3) RTU mode uses Hex data.
- (4) Each function code has following meaning.

Code(Hex)	Purpose	Used area	address	Max. response data
01	Read Coil Status	Bit output	0XXXX	2000bit
02	Read Input Status	Bit input	1XXXX	2000bit
03	Read Holding Registers	Word output	4XXXX	125word
04	Read Input Registers	Word input	3XXXX	125word
05	Force Single Coil	Bit output	0XXXX	1bit
06	Preset Single Register	Word output	4XXXX	1word
0F	Force Multiple Coils	Bit output	0XXXX	1968bit
10	Preset Multiple Registers	Word output	4XXXX	120word

## 9.4 Modbus Protocol

### 9.4.1 Reading data of bit type at the bit output (01)

#### (1) Reading bit of output area (function code: 01)

In case of reading data of bit type, request and response frame is as follows.  
Detail of frame is applied in case of ASCII mode.

##### (a) Request frame

Frame	Station no.	Function code (01)	Address	Data size	Frame error check	Tail (CRLF)
Size (byte)	1	1	2	2	2	2

##### (b) Response frame (In case of receiving normal frame)

Frame	Station no.	Function code (01)	No. of byte	Data	Frame error check	Tail (CRLF)
Size (byte)	1	1	1	N	2	2

##### (c) In case of response frame (In case of receiving abnormal frame)

Frame	Station no.	Error code	Exceptional code	Tail (CRLF)
Size (byte)	1	1	1	2

#### (2) Details of frame

- (a) Station no.: indicates the station no. of slave to read bit of output area.
- (b) Function code: '01' indicating Read Coil Status
- (c) Address: start address of data to read and it consists of 2 byte. At this time, start address conforms to modbus address regulation.
- (d) Data size: size of data to read and it consists of 2 byte.
- (e) Frame error check: in case of ASCII mode, it uses LRC and in case of STU mode, it uses CRC. It consists of 2 byte.
- (f) Tail: it is applies in case of ASCII mode, CRLF is added after LRC.
- (g) No. of byte: no. of byte of response data
- (h) Data: makes address of request frame as start address and transmits data with byte unit
- (i) Error code: error code is expressed by adding 80(Hex) to function code and in case of reading bit of output area, it is expressed as 81(Hex).
- (j) Exceptional code: indicates detail of error and consists of 1 byte

### (3) Frame example

Example that requests reading bit of 20~28 to station number 1 server acting as modbus RTU mode

#### (a) Request frame

Classification	Station no.	Function code	Address		Data size		Error check
			Upper byte	Lower byte	Upper byte	Lower byte	
Frame	01	01	00	13	00	13	CRC

#### (b) Response frame (In case receiving normal frame)

Classification	Station no.	Function code	No. of byte	Data			Error check
Frame	01	01	03	12	31	05	CRC

#### (c) Response frame (In case of receiving abnormal frame)

Classification	Station no.	Function code	Exceptional code	Error check
Frame	01	81	02	CRC

### 9.4.2 Read Input Status (02)

#### (1) Reading bit of input area

In case of reading data of bit type of input area, request and response frame is as follows.  
Tail of frame is applied in case of ASCII mode.

##### (a) Request frame

Classification	Station no.	Function code (02)	Address	Data size	Frame error check	Tail (CRLF)
Size (byte)	1	1	2	2	2	2

##### (b) Response frame (In case of receiving normal frame)

Classification	Station no.	Function code (02)	No. of byte	Data	Frame error check	Tail (CRLF)
Size (byte)	1	1	1	N	2	2

##### (c) Response frame (In case of receiving abnormal frame)

Classification	Station no.	Error code	Exceptional code	Tail (CRLF)
Size (byte)	1	1	1	2

#### (2) Details of frame

- (a) Station no.: indicates station no. of slave to read bit of input area
- (b) Function code: '02' indicating Read Input Status
- (c) Address: indicating start address of data to read. It consists of 2 byte. At this time, start address conforms to modbus address regulation.
- (d) Data size: size of data to read, consists of 2 byte
- (e) Frame error check: in case of ASCII mode, it uses LRC and in case of STU mode, it uses CRC for error check. It consists of 2 byte.
- (f) Tail: it is applied in case of ASCII mode, CRLF is added after LRC.
- (g) No. of byte: no. of byte of data responding
- (h) Data: address of request frame is start address and transmits data with byte unit.
- (i) Error code: Error code is expressed by adding 80(Hex) and in case of reading bit of output area, it is expressed 82(Hex).
- (j) Exceptional code: details of error, consists of 1 byte.

#### (3) Frame example

Example that reads bit (20~38) from station number 1 server acting as modbus RTU

##### (a) Request frame

Classification	Station no.	Function code	Address		Data size		Error check
			Upper byte	Lower byte	Upper byte	Lower byte	
Frame	01	02	00	13	00	13	CRC

##### (b) Response frame (When receiving normal frame)

Classification	Station no.	Function code	No. of byte	Data			Error check
Frame	01	02	03	12	31	05	CRC

##### (c) Response frame (When receiving abnormal frame)

Classification	Station no.	Function code	Exceptional code			Error check
----------------	-------------	---------------	------------------	--	--	-------------

Frame	01	82	02	CRC
-------	----	----	----	-----

## 9.4.3 Read Holding Registers (03)

### (1) Reading word of output area

When reading data of word type of output area, request and response frame is as follows.

Tail of frame is applied in case of ASCII mode.

#### (a) Request frame

Classification	Station no.	Function code (03)	Address	Data size	Frame error check	Tail (CRLF)
Size (byte)	1	1	2	2	2	2

#### (b) Response frame (When receiving normal frame)

Classification	Station no.	Function code (03)	No. of byte	Data	Frame error check	Tail (CRLF)
Size (Byte)	1	1	1	N*2	2	2

#### (c) Response frame (When receiving abnormal frame)

Classification	Station no.	Error code	Exceptional code	Tail (CRLF)
Size (byte)	1	1	1	2

### (2) Details of frame

(a) Station no.: indicates the station no. of slave to read word data of output area.

(b) Function code: '03' indicating Read Holding Registers

(c) Address: indicating start address of data to read. It consists of 2 byte. At this time, start address conforms to modbus address regulation.

(d) Data size: size of data to read, consists of 2 byte

(e) Frame error check: in case of ASCII mode, it uses LRC and in case of STU mode, it uses CRC for error check. It consists of 2 byte.

(f) Tail: it is applied in case of ASCII mode, CRLF is added after LRC.

(g) No. of byte: no. of byte of data responding

(h) Data: address of request frame is start address and transmits data with byte unit. At this time, since data is word type, it is double of no. of byte.

(i) Error code: error code is expressed by adding 80(Hex) and in case of reading word of output area, it is expressed 83(Hex).

(j) Exceptional code: details of error, consists of 1 byte.

### (3) Frame example

Example that reads word (108~110) from station number 1 server acting as modbus RTU

#### (a) Request frame

Classification	Station no.	Function code	Address		Data size		Error check
			Upper byte	Lower byte	Upper byte	Lower byte	
Frame	01	03	00	6B	00	03	CRC

#### (b) Response frame (receiving normal frame)

Classification	Station no.	Function code	No. of byte	Data						Error check
Frame	01	03	06	13	12	3D	12	40	4F	CRC

#### (c) Response frame (receiving abnormal frame)

Classification	Station no.	Function code	Exceptional code	Error check
Frame	01	83	04	CRC

### 9.4.4 Read Input Registers (04)

#### (1) Reading word of input area

In case of reading word of input area, request and response frame is as follows.  
Tail of frame is applied in case of ASCII mode.

##### (a) Request frame

Classification	Station no.	Function code (04)	Address	Data size	Frame error check	Tail (CRLF)
Size (byte)	1	1	2	2	2	2

##### (b) Response frame (In case of receiving normal frame)

Classification	Station no.	Function code (04)	No. of byte	Data	Frame error check	Tail (CRLF)
Size (byte)	1	1	1	N*2	2	2

##### (c) In case of response frame (In case of receiving abnormal frame)

Classification	Station no.	Error code	Exceptional code	Tail (CRLF)
Size (byte)	1	1	1	2

#### (2) Details of frame

- (a) Station no.: indicates the station no. of slave to read word of input area.
- (b) Function code: '04' indicating Read Input Registers
- (c) Address: start address of data to read and it consists of 2 byte. At this time, start address conforms to modbus address regulation.
- (d) Data size: size of data to read and it consists of 2 byte.
- (e) Frame error check: in case of ASCII mode, it uses LRC and in case of STU mode, it uses CRC. It consists of 2 byte.
- (f) Tail: it is applies in case of ASCII mode, CRLF is added after LRC.
- (g) No. of byte: no. of byte of response data
- (h) Data: makes address of request frame as start address and transmits data with byte unit. At this time, since data is word type, it is double of no. of byte.
- (i) Error code: error code is expressed by adding 80(Hex) to function code and in case of reading word of input area, it is expressed as 84(Hex).
- (j) Exceptional code: indicates detail of error and consists of 1 byte

#### (3) Frame example

Example that requests reading word of 9 to station number 1 server acting as modbus RTU mode

##### (a) Request frame

Classification	Station no.	Function code	Address		Data size		Error check
			Upper byte	Lower byte	Upper byte	Lower byte	
Frame	01	04	00	08	00	01	CRC

##### (b) Response frame (In case receiving normal frame)

Classification	Station no.	Function code	No. of byte	Data		Error check
Frame	01	04	02	00	0A	CRC

(c) Response frame (In case of receiving abnormal frame)

Classification	Station no.	Function code	Exceptional code	Error check
Frame	01	84	04	CRC

## 9.4.5 Force Single Coil (05)

### (1) Writing single bit of output area

When writing single bit of output area, request and response frame is as follows.  
Tail of frame is applied in case of ASCII mode.

(a) Request frame

Classification	Station no.	Function code (05)	Address	Output	Frame error check	Tail (CRLF)
Size (byte)	1	1	2	2	2	2

(b) Response frame (In case of receiving normal frame)

Classification	Station no.	Function code (05)	Address	Output	Frame error check	Tail (CRLF)
Size (byte)	1	1	2	2	2	2

(c) In case of response frame (In case of receiving abnormal frame)

Classification	Station no.	Error code	Exceptional code	Tail (CRLF)
Size (byte)	1	1	1	2

### (2) Details of frame

- (a) Station no.: indicates the station no. of slave to write single bit of output area.
- (b) Function code: '05' indicating Force Single Coil
- (c) Address: start address of data to write and it consists of 2 byte. At this time, start address conforms to modbus address regulation.
- (d) Output: in case of turning on address set in the Address, FF00(Hex) is indicated and in case of turning off address set in the Address, it is indicated 0000(Hex).
- (e) Frame error check: in case of ASCII mode, it uses LRC and in case of STU mode, it uses CRC. It consists of 2 byte.
- (f) Tail: it is applies in case of ASCII mode, CRLF is added after LRC.
- (g) No. of byte: no. of byte of response data
- (h) Error code: error code is expressed by adding 80(Hex) to function code and in case of Force Single Coil, it is expressed as 85(Hex).
- (i) Exceptional code: indicates detail of error and consists of 1 byte

### (3) Frame example

Example that turning on 9<sup>th</sup> bit to station number 1 server acting as Modbus RTU mode

(a) Request frame

Classification	Station no.	Function code	Address		Output		Error check
			Upper byte	Lower byte	Upper byte	Lower byte	
Frame	01	05	00	08	FF	00	CRC

(b) Response frame (In case receiving normal frame)

Classification	Station no.	Function code	Address		Output		Error check
			Upper byte	Lower byte	Upper byte	Lower byte	
Frame	01	05	00	08	FF	00	CRC

(c) Response frame (In case of receiving abnormal frame)

Classification	Station no.	Function code	Exceptional code	Error check
Frame	01	85	04	CRC

### 9.4.6 Preset Single Register (06)

#### (1) Writing single word of output area

In case of writing single word to output area, request and response frame is as follows.  
Detail of frame is applied in case of ASCII mode.

a) Request frame

Classification	Station no.	Function code (06)	Address	Output	Frame error check	Tail (CRLF)
Size (byte)	1	1	2	2	2	2

b) Response frame (In case of receiving normal frame)

Classification	Station no.	Function code (06)	Address	Output	Frame error check	Tail (CRLF)
Size (byte)	1	1	2	2	2	2

c) In case of response frame (In case of receiving abnormal frame)

Classification	Station no.	Error code	Exceptional code	Tail (CRLF)
Size (byte)	1	1	1	2

#### (2) Details of frame

- (a) Station no.: indicates the station no. of slave to write single word of output area.
- (b) Function code: '06' indicating Preset Single Register
- (c) Address: start address of data to write and it consists of 2 byte. At this time, start address conforms to modbus address regulation.
- (d) Output: data value to write in the address set in the Address.
- (e) Frame error check: in case of ASCII mode, it uses LRC and in case of STU mode, it uses CRC. It consists of 2 byte.
- (f) Tail: it is applies in case of ASCII mode, CRLF is added after LRC.
- (g) No. of byte: no. of byte of response data
- (h) Error code: error code is expressed by adding 80(Hex) to function code and in case of writing single word of output area, it is expressed as 86(Hex).
- (i) Exceptional code: indicates detail of error and consists of 1 byte

#### (3) Frame example

Example writing 0003(Hex) to 9<sup>th</sup> word of station number 1 server acting as modbus RTU mode

(a) Request frame

Classification	Station no.	Function code	Address		Output		Error check
			Upper byte	Lower byte	Upper byte	Lower byte	
Frame	01	06	00	08	00	03	CRC

(b) Response frame (In case receiving normal frame)

Classification	Station no.	Function code	Address		Output		Error check
			Upper byte	Lower byte	Upper byte	Lower byte	
Frame	01	06	00	08	00	03	CRC



(c) Response frame (In case of receiving abnormal frame)

Classification	Station no.	Function code	Exceptional code	Error check
Frame	01	86	02	CRC

### 9.4.7 Force Multiple Coils (0F)

#### (1) Writing continuous bit to output area

In case of writing continuous bit to output area, request and response frame is as follows.  
Tail of frame is applied in case of ASCII mode.

(a) Request frame

Classification	Station no.	Function code (0F)	Address	No. of output	Data size	Output	Frame error check	Tail (CRLF)
Size (byte)	1	1	2	2	1	N	2	2

(b) Response frame (In case of receiving normal frame)

Classification	Station no.	Function code (0F)	Address	No. of output	Frame error check	Tail (CRLF)
Size (byte)	1	1	2	2	2	2

(c) In case of response frame (In case of receiving abnormal frame)

Classification	Station no.	Error code	Exceptional code	Tail (CRLF)
Size (byte)	1	1	1	2

#### (2) Details of frame

- (a) Station no.: indicates the station no. of slave to write continuous bit of output area.
- (b) Function code: '06' indicating Force Multiple Coils
- (c) Address: start address of data to read and it consists of 2 byte. At this time, start address conforms to Modbus address regulation.
- (d) No. of output: no. of output to write and it consists of 2 byte  
Ex.) When writing 10 continuous data from address number 20, no. of output is 000A(Hex)
- (e) Data size: indicates no. of output as byte. Namely, in case data size is 1, no. of data is 9.  
Ex.) In case of writing 10 continuous bits, data size is 2.
- (f) Output: data value to write in the address set in the Address.
- (g) Frame error check: in case of ASCII mode, it uses LRC and in case of STU mode, it uses CRC. It consists of 2 byte.
- (h) Tail: it is applies in case of ASCII mode, CRLF is added after LRC.
- (i) No. of byte: no. of byte of response data
- (j) Error code: error code is expressed by adding 80(Hex) to function code and in case of writing continuous bit of output area, it is expressed as 8F(Hex).
- (k) Exceptional code: indicates detail of error and consists of 1 byte.

### (3) Frame example

Example writing 10 continuous bits starting 20<sup>th</sup> address of 1 server acting as Modbus RTU mode

Ex.) Data value to write continuously

Bit value	1	1	0	0	1	1	0	1	0	0	0	0	0	0	0	1
Hex	C				D				0				1			
Address	27	26	25	24	23	22	21	20	-	-	-	-	-	-	29	28

(a) Request frame

Classification	Station no.	Function code	Address		No. of output		Data size	Output		Error check
			Upper byte	Lower byte	Upper byte	Lower byte		Upper byte	Lower byte	
Frame	01	0F	00	13	00	0A	02	CD	01	CRC

(b) Response frame (In case receiving normal frame)

Classification	Station no.	Function code	Address		No. of output		Error check
			Upper byte	Lower byte	Upper byte	Lower byte	
Frame	01	04	00	13	00	0A	CRC

(c) Response frame (In case of receiving abnormal frame)

Classification	Station no.	Function code	Exceptional code	Error check
Frame	01	8F	01	CRC

## 9.4.8 Preset Multiple Registers (10)

### (1) Writing word continuously to output area

In case of writing word continuously to output area, request and response frame is as follows.

Tail of frame is applied in case of ASCII mode.

#### (a) Request frame

Classification	Station no.	Function code (10)	Address	No. of output	Data size	Output	Frame error check	Tail (CRLF)
Size (byte)	1	1	2	2	1	N*2	2	2

#### (b) Response frame (In case of receiving normal frame)

Classification	Station no.	Function code (10)	Address	No. of output	Frame error check	Tail (CRLF)
Size (byte)	1	1	2	2	2	2

#### (c) In case of response frame (In case of receiving abnormal frame)

Classification	Station no.	Error code	Exceptional code	Tail (CRLF)
Size (byte)	1	1	1	2

### (2) Details of frame

(a) Station no.: indicates the station no. of slave to write continuous word of output area.

(b) Function code: '10' indicating Preset Multiple Registers

(c) Address: start address of data to read and it consists of 2 byte. At this time, start address conforms to modbus address regulation.

(d) No. of output: no. of output to write and it consists of 2 byte

Ex.) When writing 10 continuous data from address number 20, no. of output is 000A(Hex)

(e) Data size: indicates no. of output as byte. Since data type is word, in case of writing data of 1 word, data size is 2.

(f) Output: data value to write in the address set in the Address.

(g) Frame error check: in case of ASCII mode, it uses LRC and in case of STU mode, it uses CRC. It consists of 2 byte.

(h) Tail: it applies in case of ASCII mode, CRLF is added after LRC.

(i) No. of byte: no. of byte of response data

(j) Error code: error code is expressed by adding 80(Hex) to function code and in case of writing continuous word of output area, it is expressed as 90(Hex).

(k) Exceptional code: indicates detail of error and consists of 1 byte.

**(3) Frame example**

Example writing continuous 2 words starting 20<sup>th</sup> address of server 1 acting as Modbus RTU mode

Ex.) value to write continuously

Hex	C	D	0	1	0	0	0	A
Address	20				21			

(a) Request frame

Classification	Station no.	Function code	Address		No. of output		Data size	Output				Error check
			Upper byte	Lower byte	Upper byte	Lower byte						
Frame	01	10	00	13	00	02	04	CD	01	00	0A	CRC

(b) Response frame (In case receiving normal frame)

Classification	Station no.	Function code	Address		No. of output		Error check
			Upper byte	Lower byte	Upper byte	Lower byte	
Frame	01	10	00	13	00	02	CRC

(c) Response frame (In case of receiving abnormal frame)

Classification	Station no.	Function code	Exceptional code	Error check
Frame	01	90	01	CRC

## Chapter 10 Diagnosis

With XG5000 used, the status of the system and the network can be checked and diagnosed.

Diagnosis function is composed as described below

- ▶ CPU module information
- ▶ Communication module information
- ▶ Frame monitor
- ▶ Status by service

### 10.1 Diagnosis Function of XG5000

How to diagnosis system and network status by XG5000 system diagnosis are described below.

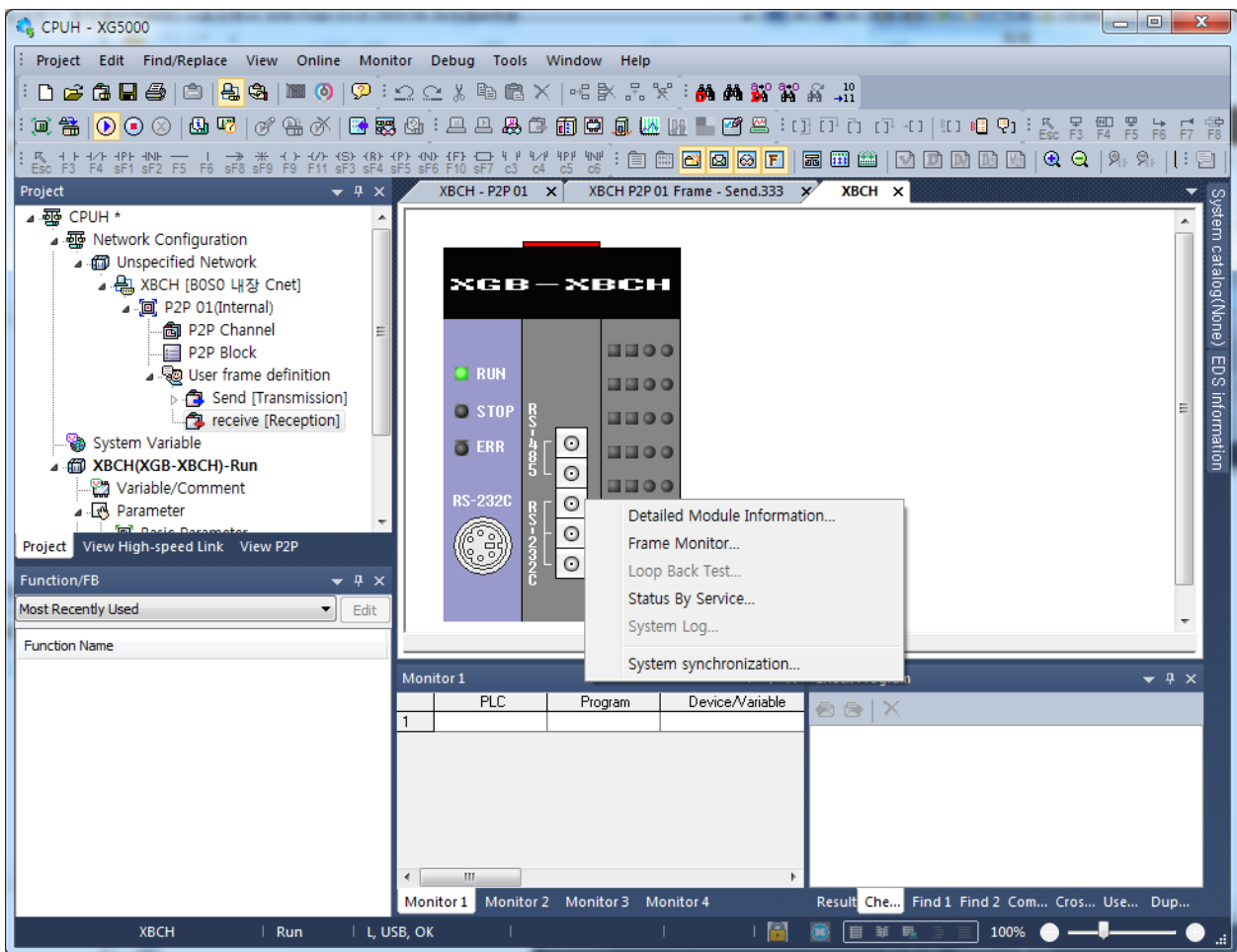

Connect XG5000 to loader port of main unit and if you select "Online -> Communication module setting -> System Diagnosis", the following window is created.



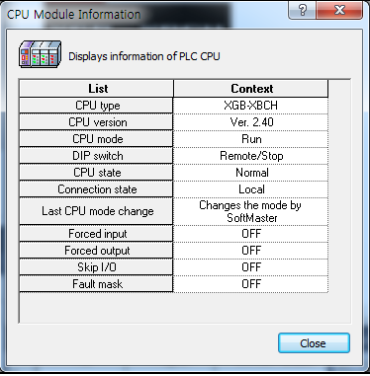

[Figure 11.1.1] System diagnosis window

- Select [Online] - [Communication module setting] - [System Dianosis] and click the icon ( ).
- Click the right button on the the relevant module and click Frame Monitor or Status By Service to check.

10.1.1 Checking status of main unit

Check list	Detail result																								
<p>CPU Module information</p>	 <p>The screenshot shows a dialog box titled "CPU Module Information" with a table of PLC CPU details. The table has two columns: "List" and "Context".</p> <table border="1"> <thead> <tr> <th>List</th> <th>Context</th> </tr> </thead> <tbody> <tr><td>CPU type</td><td>XGB-XBCH</td></tr> <tr><td>CPU version</td><td>Ver. 2.40</td></tr> <tr><td>CPU mode</td><td>Run</td></tr> <tr><td>DIP switch</td><td>Remote/Stop</td></tr> <tr><td>CPU state</td><td>Normal</td></tr> <tr><td>Connection state</td><td>Local</td></tr> <tr><td>Last CPU mode change</td><td>Changes the mode by SoftMaster</td></tr> <tr><td>Forced input</td><td>OFF</td></tr> <tr><td>Forced output</td><td>OFF</td></tr> <tr><td>Skip I/O</td><td>OFF</td></tr> <tr><td>Fault mask</td><td>OFF</td></tr> </tbody> </table>	List	Context	CPU type	XGB-XBCH	CPU version	Ver. 2.40	CPU mode	Run	DIP switch	Remote/Stop	CPU state	Normal	Connection state	Local	Last CPU mode change	Changes the mode by SoftMaster	Forced input	OFF	Forced output	OFF	Skip I/O	OFF	Fault mask	OFF
List	Context																								
CPU type	XGB-XBCH																								
CPU version	Ver. 2.40																								
CPU mode	Run																								
DIP switch	Remote/Stop																								
CPU state	Normal																								
Connection state	Local																								
Last CPU mode change	Changes the mode by SoftMaster																								
Forced input	OFF																								
Forced output	OFF																								
Skip I/O	OFF																								
Fault mask	OFF																								
<ol style="list-style-type: none"> <li>1. Select [Online] – [Communication module setting] - [System Diagnosis] or click the icon (  ).</li> <li>2. You can check the status of main unit by clicking CPU module information after clicking main unit.</li> </ol>																									

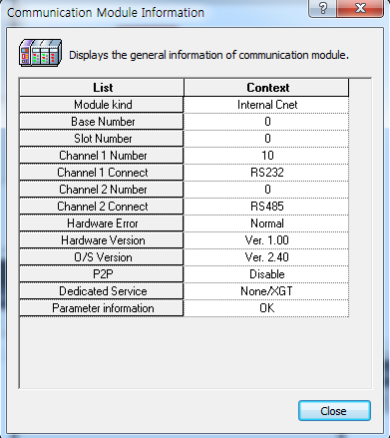
10.1.2 Communication module information

Check list	Detail result																												
<p>Communication module information</p>	 <p>The screenshot shows a dialog box titled "Communication Module Information" with a table of general information. The table has two columns: "List" and "Context".</p> <table border="1"> <thead> <tr> <th>List</th> <th>Context</th> </tr> </thead> <tbody> <tr><td>Module kind</td><td>Internal Cnet</td></tr> <tr><td>Base Number</td><td>0</td></tr> <tr><td>Slot Number</td><td>0</td></tr> <tr><td>Channel 1 Number</td><td>10</td></tr> <tr><td>Channel 1 Connect</td><td>RS232</td></tr> <tr><td>Channel 2 Number</td><td>0</td></tr> <tr><td>Channel 2 Connect</td><td>RS485</td></tr> <tr><td>Hardware Error</td><td>Normal</td></tr> <tr><td>Hardware Version</td><td>Ver. 1.00</td></tr> <tr><td>O/S Version</td><td>Ver. 2.40</td></tr> <tr><td>P2P</td><td>Disable</td></tr> <tr><td>Dedicated Service</td><td>None/IGT</td></tr> <tr><td>Parameter information</td><td>OK</td></tr> </tbody> </table>	List	Context	Module kind	Internal Cnet	Base Number	0	Slot Number	0	Channel 1 Number	10	Channel 1 Connect	RS232	Channel 2 Number	0	Channel 2 Connect	RS485	Hardware Error	Normal	Hardware Version	Ver. 1.00	O/S Version	Ver. 2.40	P2P	Disable	Dedicated Service	None/IGT	Parameter information	OK
List	Context																												
Module kind	Internal Cnet																												
Base Number	0																												
Slot Number	0																												
Channel 1 Number	10																												
Channel 1 Connect	RS232																												
Channel 2 Number	0																												
Channel 2 Connect	RS485																												
Hardware Error	Normal																												
Hardware Version	Ver. 1.00																												
O/S Version	Ver. 2.40																												
P2P	Disable																												
Dedicated Service	None/IGT																												
Parameter information	OK																												
<ol style="list-style-type: none"> <li>1. Select [Online] – [Communication module setting] - [System Diagnosis] or click the icon (  ).</li> <li>2. You can check communication module status by clicking communication module information and click the right button after clicking Cnet I/F module and built-in communication.</li> <li>3. Meaning of each item of communication module information is as follows.</li> </ol>																													

Item	Content	Ref.
Module kind	Information of module kind under diagnosis	
Base number	Base information of communication module under diagnosis. It is fixed as 0 at XGB PLC.	
Slot number	Slot no. of communication module under diagnosis In case of built-in communication, it is fixed as 0.	
Station number	Station no. of relevant channel used at dedicated service, P2P	
Connection method	Information of communication type (RS-232C, RS-422) of relevant channel	
Hardware error	Indicates whether hardware of communication module is normal or not.	
Hardware version	Version of communication module hardware	
OS version	Indicates version of communication module OS	
P2P	Indicates whether P2P communication is activated or not	
System parameter information	Whether standard communication parameter is downloaded or not Standard communication parameter error information expression	

## 10.1.3 Frame monitor

The user can check whether frame is normal or not by monitoring TRX frame through Cnet I/F module by XG5000's frame monitor.

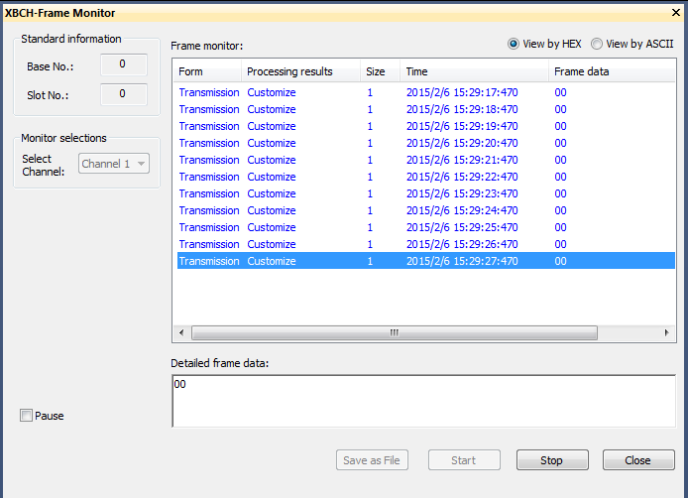
Check list	Detail result
Frame monitor	

1. Select [Online] – [Communication module setting] - [System Diagnosis] or click the icon (  ).
2. If you click right button after clicking Cnet I/F module and click frame monitor, you can monitor current communication data.
3. If you use frame monitor function, you can check frame of TRX data between Cnet I/F module and external communication device easily.
4. Detailed content of information indicated frame monitor window is as follows.

Item	Content	Ref.	
Standard information	Base No.	Information of base number under diagnosis	
	Slot No.	Information of slot number under diagnosis	
Monitor selections	Select Channel	Select channel to monitor	
Frame monitor window	Form	Indicates whether it is TX or RX frame.	
	Result	Indicates the protocol type 1) XGT server 2) XGT client 3) Modbus server 4) Modbus client 5) User definition frame 6) Unknown: frame that Cnet can't deal with	
	Size	Size of frame	
	Time	Time when sending/receiving the frame In case main unit is standard type (XBM-D***S), it indicates elapsed time from start.	
	Frame data	Indicates the frame data	
	View by HEX	Indicates the frame data as HEX	
	View by ASCII	Indicates the frame data as ASCII	
	Start	Starts the frame monitor	
	Stop	Stops the frame monitor	
	Close	Closes the frame monitor window	

10.1.4 Status by service

Check list	Detail result
<p>Dedicated service</p>	

1. Select [Online] – [Communication module setting] - [System Diagnosis] or click the icon ( ).
2. Click the right button on the the Cnet I/F module and click Status By Service.
3. Click Dedicated Service tap.
4. Check the status by service by clicking Multiple Reading and Refresh
5. Detailed content of information indicated in dedicated service window is as follows.

Classification	Item	Content	
Multiple reading/Refresh	Multiple reading	Checks the dedicated service status every second.	
	Refresh	Checks the dedicated service status information at started time	
Dedicated Service	Standard information	Base Number	Information of base number under diagnosis
		Slot Number	Information of slot number under diagnosis
		Link type	Type of communication module under diagnosis
	Dedicated service information	Drive type by service	
	Detailed information window	Port number	Channel number
		Service count	Indicates how many dedicated service communication is done
		Error count	Indicates how many error occurs during dedicated service communication
Status		Indicates status of dedicated service communication	

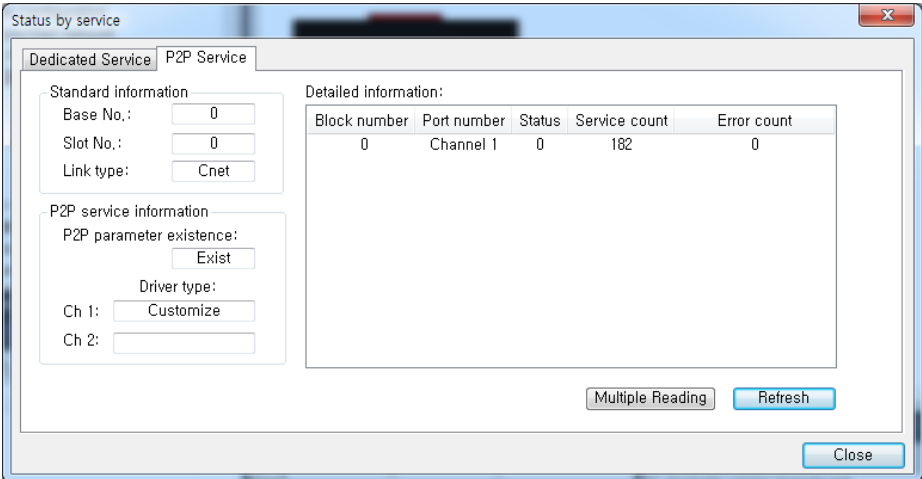

Check list	Detail result
P2P service	

1. Select [Online] – [Communication module setting] – [System diagnosis] or click the icon (  ).
2. Click the right button on the the Cnet I/F module and click Status By Service.
3. Click P2P service of Status by Service
4. Click mutiple reading and check Status by Service.

Classification	Item	Contents	
P2P service	Standard information	Base number	Information of base number under diagnosis
		Slot number	Information of slot number under diagnosis
		Link type	Type of communication module under diagnosis
	P2P service information	P2P parameter existence	Indicates whether P2P parameter exists or not
		Driver type	Indicates the P2P driver by port XGT/Modbus/User definition frame
	Detailed information	Block number	Available range:0~63 Only block under operation is indicated.
		Port number	Indicates the channel number
Status		Indicates the status by service	
Service count		Indicates how many P2P service is done.	
Error count	Indicates how many error occurs during service		
Multiple reading/Refresh	Multiple reading	Checks the P2P service status every second.	
	Refresh	Check the P2P service status when refresh is done.	

► Service status code

It is used to check whether Cnet I/F module is normal or not.

Dedicated service		P2P service	
Status	Meaning	Status	Meaning
0	Normal	0	Normal
1	Error of RX frame head (There is no ACK/NAK.)	4	Error of max. station number (Available range: 0~255)
2	Error of RX frame tail (There is no tail.)	5	Time out
3	BCC error of RX frame	FFFE	1. Modbus address error 2. Commands except Read/Write are used.
9	Station number of RX frame is different with self station number (Self station number = 0)		-
0A	In case of not get response from CPU		
0B	RX frame size exceeds the modbus max. frame size		
0C	RX frame is not Modbus ASCII/RTU.		
0D	HEX conversion error in Modbus		

## 10.2 Trouble Shooting by Error

### 10.2.1 Trouble shooting when P2P parameter setting error occurs in case of XG5000 connection

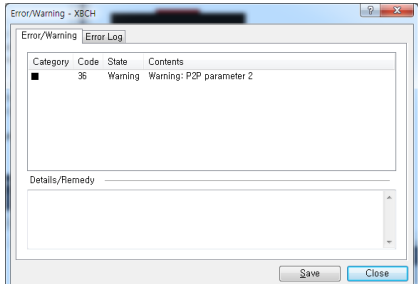
Phenomenon	Reason	Trouble shooting
<p>P2P setting error warning in case of XG5000 connection</p> 	<p>In case of enabling link, the user enabled the link where P2P is not set</p>	<ol style="list-style-type: none"> <li>1. In Enable Link menu of XG5000, check P2P setting number and delete P2P number not selected properly.</li> <li>2. After disconnecting XG5000, connect XG5000 again and check</li> </ol>

### 10.2.2 Trouble shooting when communication is not done after P2P client setting

Phenomenon	Reason	Trouble shooting
<p>Tough communication setting is completed, Tx/Rx LED of Cnet I/F doesn't flicker</p>	<p>In case CPU is stop mode</p>	<p>Connect XG5000 and check CPU mode. If CPU mode is stop, change mode into RUN.</p>
	<p>Non-coincidence of communication standard parameter between client and server</p>	<p>Connect XG5000 and click [Project] – [Open from PLC]. Check standard settings of module acting as client and server.</p>
	<p>Enable Link setting error</p>	<p>After executing P2P parameter, enable right P2P link</p>

### 10.2.3 Trouble shooting when response frame is missed in case of acting as client and using RS-485

Phenomenon	Reason	Trouble shooting
<p>After setting diverse P2P parameter in P2P block, if frame monitor is executed, response frame is missed.</p>	<p>In case P2P conditional flag is faster than communication time</p>	<ol style="list-style-type: none"> <li>1. Consider communication time and change P2P conditional flag.</li> <li>2. Communication time: transmission time + receive time                      - transmission time = conditional flag + CPU Scan Time + reaction time of communication module + data transmission time                      - receive time: CPU Scan Time + reaction time of communication module + data transmission time</li> </ol>
	<p>In case that response time of partner is slow.</p>	<ol style="list-style-type: none"> <li>1. Increase Delay time in standard settings of XG5000.</li> </ol>

### 10.2.4 Two response frame are dealt with as unknown when executing frame monitor

Phenomenon				Reason	Trouble shooting
Two response frame are dealt with as unknown when executing frame monitor				Communication type in XG5000 is set as RS-422 but output wiring method is RS-485	Change communication type as RS-485 and write it to PLC.
Transmission	XGT master	17	2007/12/4 ... ENQ 01 r S S 01 0 4 % M W 0 E D T 4 0		
Reception	Unknown	17	2007/12/4 ... ENQ 01 r S S 01 0 4 % M W 0 E D T 4 0		
Reception	Unknown	17	2007/12/4 ... ACK 01 r S S 01 0 2 0 0 0 0 E T X 0 5		
Transmission	XGT master	17	2007/12/4 ... ENQ 01 r S S 01 0 4 % M W 0 E D T 4 0		

### 10.2.5 Unable to analyze TRX frame

Phenomenon	Reason	Trouble shooting
Unable to analyze TRX frame	More than one server sends frame	1. Execute 1:1 communication with server and check if it works properly. 2. Take interlock for servers not to sends frame simultaneously.
	In case parity bit setting is not coincident	Set the parity bit to be same each other
	In case stop bit setting is not coincident	Set the stop bit to be same each other
	In case communication speed setting is not coincident	Set the communication speed to be same each other
	In case of multi drop, terminal resistance is not installed	Install terminal resistance

### 10.2.6 Unable to know which one is reason of error, client or server

Phenomenon	Reason	Trouble shooting
Unable to know which one is reason of error, client or server	-	1. Check Cnet I/F module - Check module's equipment status - Check wiring 2. Check main unit status

**10.2.7 Communication is not normal or communication is not executed repeatedly**

Phenomenon	Reason	Trouble shooting
Communication is not normal or communication is not executed repeatedly	In case of multi drop, More than one server sends frame	1. Execute 1:1 communication with server and check if it works properly. 2. Take interlock for servers to sends frame simultaneously.
	Connection error of wiring communication line	Change cable or check connection of cable
	In case of RS-485 (Half duplex), non-coincidence of timing of TRX signal	Increase delay time of client and server
	1. When transmission is not complete, it requests next process of transmission 2. When receive is not complete, it requests next process of receive	Use handshake in program thoroughly



# Chapter 11 Example Program

## 11.1 Setting of Cnet I/F module in the XG5000

Operation of XGT Cnet I/F is divided into P2P service and Server.

- P2P service: acts as client (master) and request reading/writing.
  - XGT client
  - Modbus RTU/ASCII client
  - User frame definition
- Server: acts as server (slave) and acts according to request
  - XGT server
  - Modbus RTU server
  - Modbus ASCII server

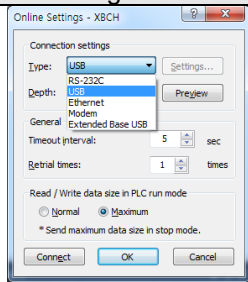
### 11.1.1 In case of acting as server

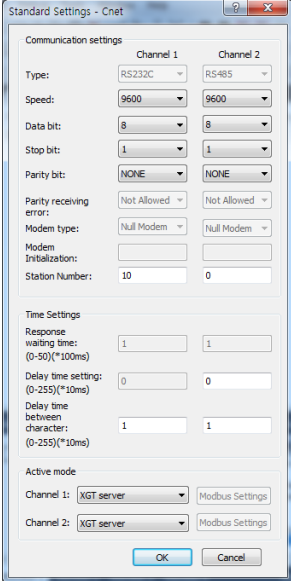



Sequence	Procedure	Setting method
1	Connection setting	
	1. Select [Online]-[Connection Settings] or click icon  2. Click [Connect] after setting.	
2	Read I/O information	Select [Online] – [Diagnosis] – [I/O Information] and click [I/O Sync] Reads the information about currently equipped module.
3	Standard Settings	
	1. Double-click Cnet I/F module and execute standard setting window. Set Type, Speed, Data bit, Stop bit, station no. of connection menu. 2. Modem initialization is available in case of dial modem, not null modem. 3. Delay time setting: when sending frame, it sends frame after specific delay time. (a) Operation setting: Available when type is RS-422/485. * When using as Modbus ASCII server, data bit should be 7	

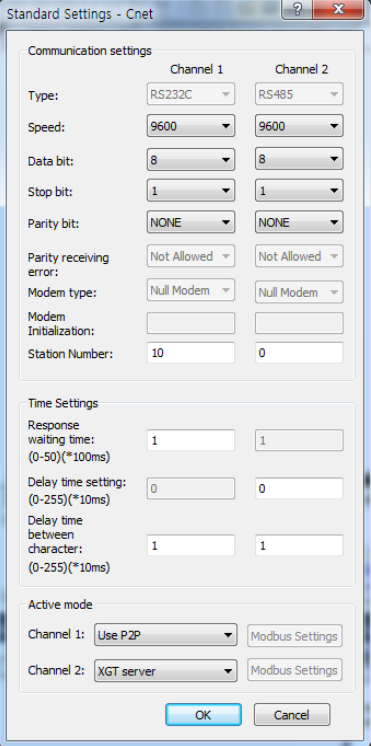
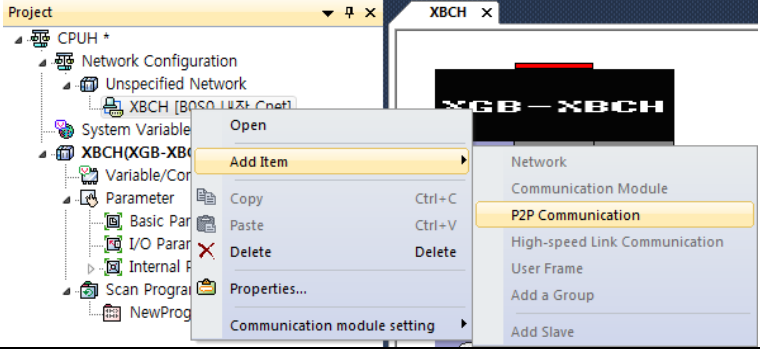
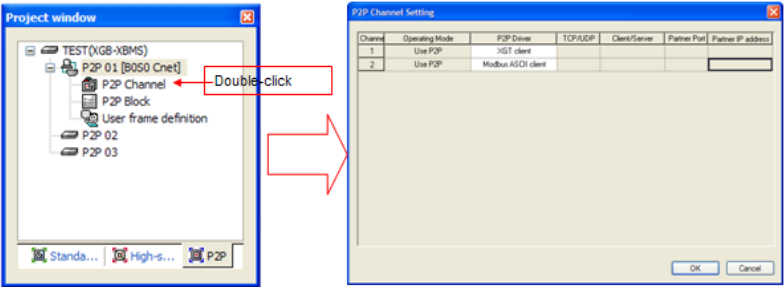

Sequence	Procedure	Setting method
4	Selecting the active mode	1. Select active mode of server for user to use. 2. XGB Cnet I/F module supports XGT server, Modbus ASCII server, Modbus RTU server.
5	Writing parameter	<div data-bbox="619 376 1332 831" style="border: 1px solid gray; padding: 5px; margin-bottom: 10px;"> </div> <ol style="list-style-type: none"> <li>1. Select [Online] – [Write] or click icon (  )</li> <li>2. Click [OK].</li> <li>3. If you click [OK] button, parameter is sent to PLC.                          If you don't reset relevant module, XGB Cnet I/F module acts as changed parameter.</li> </ol>
6	Checking the operation	<div data-bbox="598 1025 1348 1630" style="border: 1px solid gray; padding: 5px; margin-bottom: 10px;"> </div> <ol style="list-style-type: none"> <li>1. Select [Online] – [Communication module setting] – [System Diagnosis] or click icon (  ).</li> <li>2. Click the right button on the relevant module and click Frame Monitor or Status By Service to check</li> </ol>

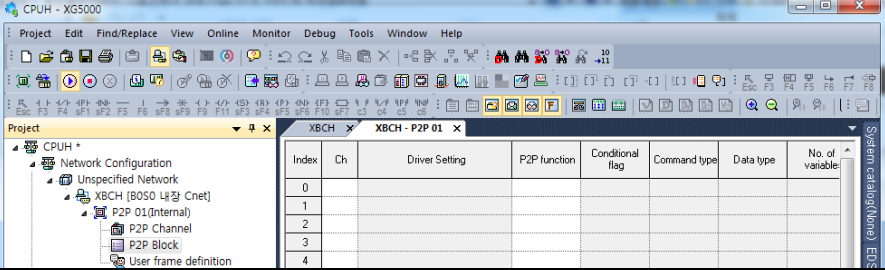
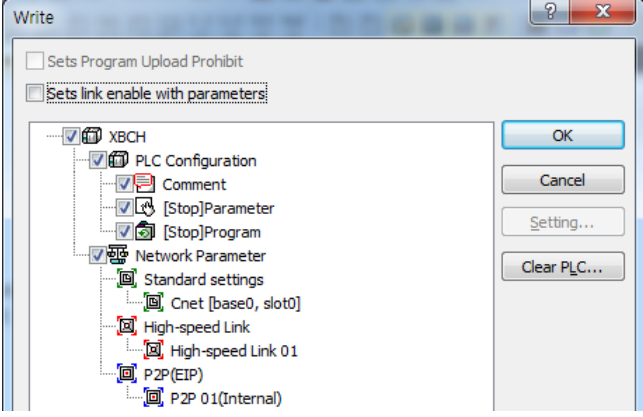
11.1.2 In case of acting as P2P service (client)

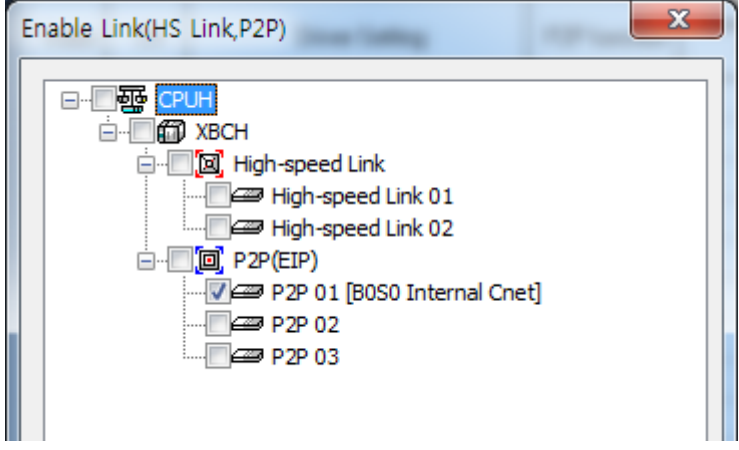
Sequence	Procedure	Setting method
1	Standard settings	1. Step 1~3 is same as described above. *In case of ASCII client, data bit should be 7.
2	Active mode	
		1. Select Use P2P settings as active mode.
3	P2P settings	
		<p>1. Right click the Cnet I/F module in the project tree and select [Add Item]-[P2P Communication].</p> <p>2. P2P 01 is fixed as built-in Cnet and base and slot is fixed as 0 and you can't change that.</p>
4	P2P channel setting	
		<p>1. Double-click P2P driver and select protocol according to each channel.</p> <p>2. P2P driver supports user definition frame, XGT client, Modbus RTU/ASCII client.</p>

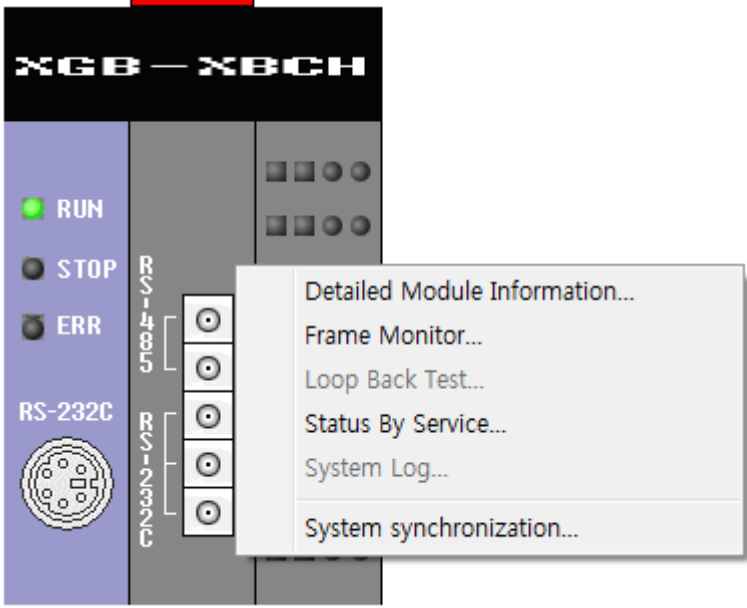

Sequence	Procedure	Setting method
5	P2P block setting	 <p>The screenshot shows the 'CPUH - XG5000' software interface. The project tree on the left includes 'CPUH', 'Network Configuration', 'Unspecified Network', 'XBCH (BOS0 나장 Cnet)', 'P2P 01(Internal)', 'P2P Channel', 'P2P Block', and 'User frame definition'. A table titled 'XBCH - P2P 01' is displayed with the following columns: Index, Ch, Driver Setting, P2P function, Conditional flag, Command type, Data type, and No. of variable. The table contains four rows of data.</p> <ol style="list-style-type: none"> <li>1. P2P items are activated differently according to type of client set in the channel.</li> <li>2. Write shell according to protocol</li> </ol> <p>* In case of user definition frame, P2P block can be set when user definition frame is written.</p>
6	Writing parameter	 <p>The screenshot shows the 'Write' dialog box. It has two checkboxes at the top: 'Sets Program Upload Prohibit' (unchecked) and 'Sets link enable with parameters' (checked). Below these is a tree view showing the project structure with 'XBCH' selected. Under 'XBCH', several items are checked, including 'PLC Configuration', 'Comment', '[Stop]Parameter', '[Stop]Program', 'Network Parameter', 'Standard settings', 'Cnet [base0, slot0]', 'High-speed Link', 'High-speed Link 01', 'P2P(EIP)', and 'P2P 01(Internal)'. Buttons for 'OK', 'Cancel', 'Setting...', and 'Clear PLC...' are on the right.</p> <ol style="list-style-type: none"> <li>1. Select [Online] – [Write] or click icon (  ).</li> <li>2. Click [OK].</li> <li>3. If you press [OK], parameter is sent to PLC.</li> </ol> <p>If you don't reset relevant module, XGB Cnet I/F module acts as changed parameter.</p>
7	Enabling the link	 <p>The screenshot shows the 'Enable Link(HS Link,P2P)' dialog box. It displays a tree view of the project structure. Under 'XBCH', 'High-speed Link' is selected. Below it, 'High-speed Link 01', 'High-speed Link 02', 'P2P(EIP)', 'P2P 01 [BOS0 Internal Cnet]', 'P2P 02', and 'P2P 03' are listed. The 'P2P 01 [BOS0 Internal Cnet]' item is checked.</p> <ol style="list-style-type: none"> <li>1. Select [Online] – [Communication module setting] – [Enable Link] or click icon (  ).</li> <li>2. Click the P2P to enable and click Write.</li> </ol>

Sequence	Procedure	Setting method
8	Checking the operation	 <p>The screenshot shows a control panel interface for 'XGB - XBCH'. On the left, there are three status indicators: 'RUN' (with a green dot), 'STOP', and 'ERR'. Below these is an 'RS-232C' label and a circular icon. To the right, there are two vertical columns of buttons labeled 'RS-485' and 'RS-232C'. A context menu is open over one of the buttons, listing several diagnostic options: 'Detailed Module Information...', 'Frame Monitor...', 'Loop Back Test...', 'Status By Service...', 'System Log...', and 'System synchronization...'.</p>
<p>1. Select [Online] – [Communication module setting] – [System Diagnosis] or click icon (  ).</p> <p>2. Click the right button on the relevant module and click Frame Monitor or Status By Service to check.</p>		

## 11.2 Dedicated Communication Example

Dedicated communication?

- As defined protocol by LSIS, it is classified XGT client and XGT server
- XGT client: requests reading/writing of data to server
- XGT server: responds according to request of client

We assume that system configuration of dedicated service example is as [Figure 10.2.1] and communication setting is as following table.

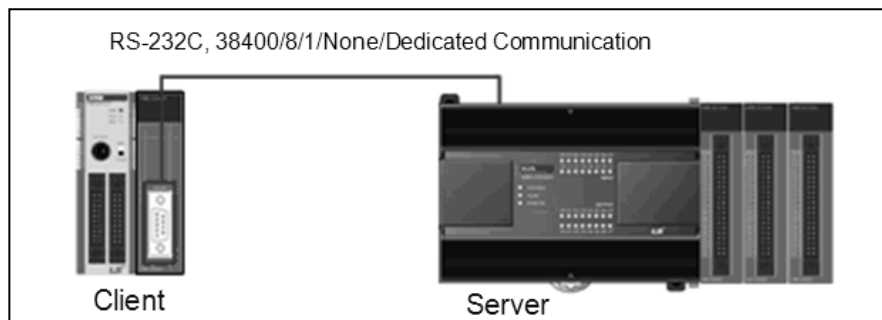

[Figure 11.2.1] Example of dedicated service system configuration

### • Client setting

Type	Setting content
Main unit	XBM-DN16S
Communication module	XBL-C21A (1 slot)
Communication type	RS-232C
Communication speed	38,400
Data bit	8
Stop bit	1
Parity bit	None
Modem type	Null modem
Operation cycle	200ms
Operation status	Write
	Read
	Saves 1 word of M100 at client to M100 at server
	Saves 1 word of D100 at server to M110 at client

[Table 11.2.1] client setting



### • Server setting

Type	Setting content
Main unit	XBC-DN32H
Communication module	Main unit built-in (RS-232C)
Communication type	RS-232C
Communication speed	38,400
Data bit	8
Stop bit	1
Parity bit	None
Modem type	Null modem
Station no.	1

[Table 11.2.2] Server setting

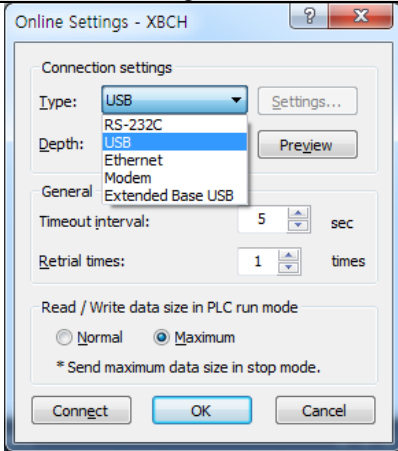

11.2.1 Settings of XGT server

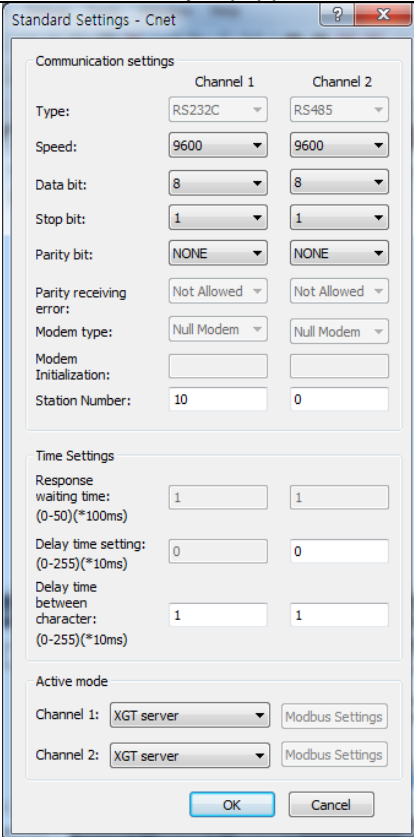
Setting method to operate built-in RS-232C communication channel of XBC-DN32H as server is as follows.

Sequence	Procedure	Setting method
1	Connection settings	
		<ol style="list-style-type: none"> <li>1. Select [Online]-[Connection Settings] or click icon()</li> <li>2. Click [Connect] after setting.</li> </ol>
2	Reading IO information	Select [Online] – [Diagnosis] – [I/O Information] and click [I/O Sync] Reads the information about currently equipped module.
3	Standard settings	
		<ol style="list-style-type: none"> <li>1. Set standard settings at built-in communication channel to be same with [Table 11.2.2]'s standard settings.</li> <li>2. Since active mode acts as dedicated communication server, set as XGT server.</li> </ol>

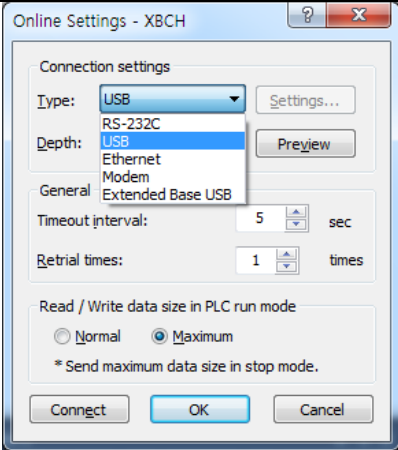

### 11.2.2 Settings of XGT client

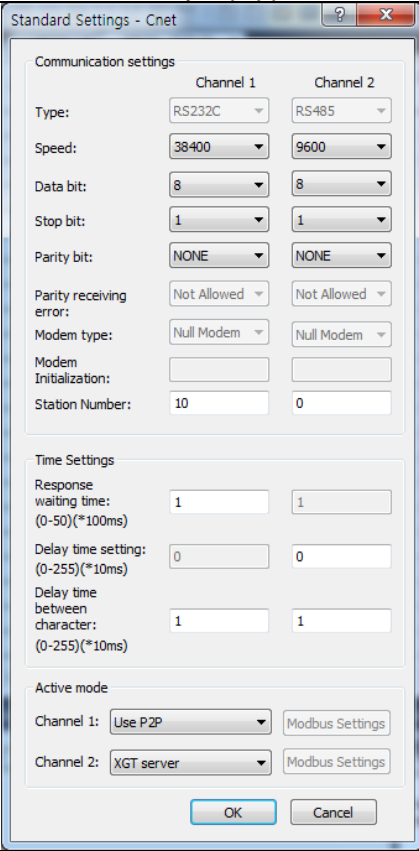

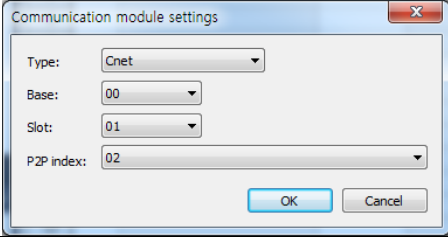
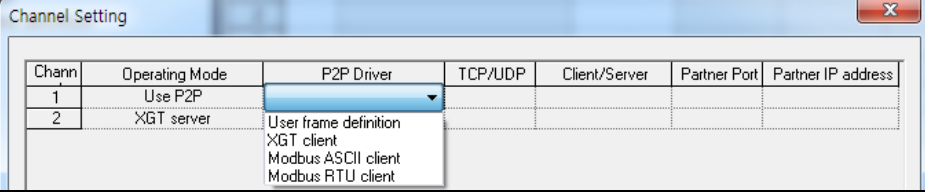

To operate XBL-C21A of client as XGT client, set Cent I/F module as follows.

Sequence	Procedure	Setting method
1	Connection settings	
		<ol style="list-style-type: none"> <li>1. Select [Online]-[Connection Settings] or click icon()</li> <li>2. Click [Connect] after setting.</li> </ol>
2	Reading IO information	Select [Online] – [Diagnosis] – [I/O Information] and click [I/O Sync] Reads the information about currently equipped module.
3	Standard settings	
		<ol style="list-style-type: none"> <li>1. Select XBL-C21A and set standard setting at channel 2 to be same with setting described in [Table 11.2.1].</li> <li>2. In case of acting as client, station setting doesn't have the meaning so set temporary station (0~255).</li> <li>3. When acting as client, active mode should be [Use P2P settings].</li> </ol>

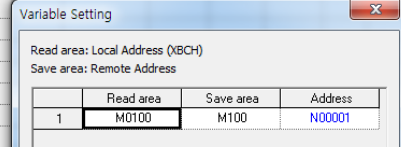
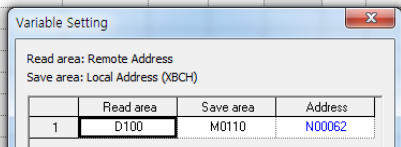
# Chapter 11 Example program

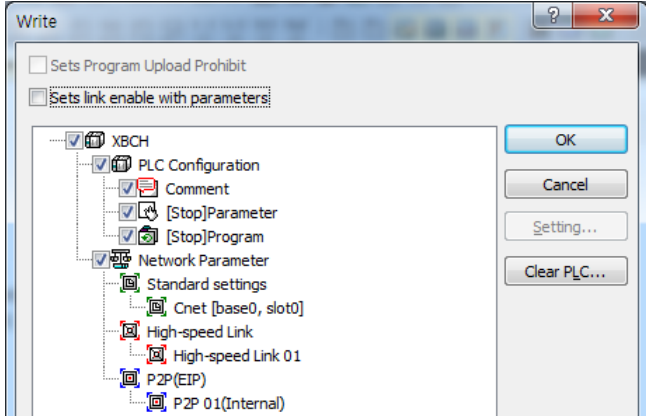

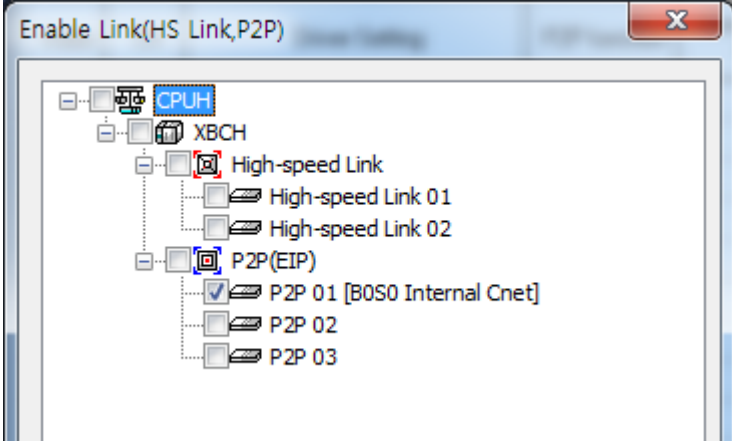
After standard settings, P2P channel and P2P block should be set. Setting methods are as follows.

Sequence	Procedure	Setting method																																																																																																																																												
1	P2P setting	Click  P2P bottom of project tree																																																																																																																																												
2	Communication module settings	 <p>1. Right click PLC and select [Add Item] – [P2P Communication] 2. Select slot number acting as client and press OK.</p>																																																																																																																																												
3	P2P channel setting	 <p>1. Double-click  of P2P 02 and set P2P driver of channel 2 as <input type="text" value="XGT client"/></p>																																																																																																																																												
4		1. Double-click  of P2P 02.																																																																																																																																												
5	Setting of writing operation	 <table border="1" data-bbox="472 938 1426 1178"> <thead> <tr> <th>Index</th> <th>Ch</th> <th>Driver Setting</th> <th>P2P function</th> <th>Conditional flag</th> <th>Command type</th> <th>Data type</th> <th>No. of variables</th> <th>Data size</th> <th>Destination station</th> <th>Destination station number</th> <th>Frame</th> <th>Setting</th> <th>Variable setting contents</th> </tr> </thead> <tbody> <tr> <td>0</td> <td>1</td> <td>XGT client</td> <td>WRITE</td> <td>F00092</td> <td>Single</td> <td>2 BYTE</td> <td>1</td> <td></td> <td><input checked="" type="checkbox"/></td> <td>1</td> <td></td> <td>Setting</td> <td>Number:1 READ1:M0100,SAVE1:M100</td> </tr> <tr> <td>1</td> <td></td> <td></td> <td></td> <td></td> <td></td> <td></td> <td></td> <td></td> <td></td> <td></td> <td></td> <td>Setting</td> <td></td> </tr> <tr> <td>2</td> <td></td> <td></td> <td></td> <td></td> <td></td> <td></td> <td></td> <td></td> <td></td> <td></td> <td></td> <td>Setting</td> <td></td> </tr> <tr> <td>3</td> <td></td> <td></td> <td></td> <td></td> <td></td> <td></td> <td></td> <td></td> <td></td> <td></td> <td></td> <td>Setting</td> <td></td> </tr> <tr> <td>4</td> <td></td> <td></td> <td></td> <td></td> <td></td> <td></td> <td></td> <td></td> <td></td> <td></td> <td></td> <td>Setting</td> <td></td> </tr> <tr> <td>5</td> <td></td> <td></td> <td></td> <td></td> <td></td> <td></td> <td></td> <td></td> <td></td> <td></td> <td></td> <td>Setting</td> <td></td> </tr> <tr> <td>6</td> <td></td> <td></td> <td></td> <td></td> <td></td> <td></td> <td></td> <td></td> <td></td> <td></td> <td></td> <td>Setting</td> <td></td> </tr> <tr> <td>7</td> <td></td> <td></td> <td></td> <td></td> <td></td> <td></td> <td></td> <td></td> <td></td> <td></td> <td></td> <td>Setting</td> <td></td> </tr> </tbody> </table> <p>1. Channel: Select ch.2 set as XGT client set in P2P channel. 2. Since it executes write operation, select WRITE. 3. Conditional flag: to send frame every 200ms, use flag F92. 4. Command type, Data type: to write 1 word, select single and 2 byte. 5. No. of variable: since no. of word is 1, select 1. 6. Destination station number: input 1 as station number of server. 7. Setting: after setting Read area and Save area, click OK. 1) Read area: device address of data saved in the client 2) Save area: device address of server to save data * If all settings are completed, color of index of channel becomes black.</p>	Index	Ch	Driver Setting	P2P function	Conditional flag	Command type	Data type	No. of variables	Data size	Destination station	Destination station number	Frame	Setting	Variable setting contents	0	1	XGT client	WRITE	F00092	Single	2 BYTE	1		<input checked="" type="checkbox"/>	1		Setting	Number:1 READ1:M0100,SAVE1:M100	1												Setting		2												Setting		3												Setting		4												Setting		5												Setting		6												Setting		7												Setting															
Index	Ch	Driver Setting	P2P function	Conditional flag	Command type	Data type	No. of variables	Data size	Destination station	Destination station number	Frame	Setting	Variable setting contents																																																																																																																																	
0	1	XGT client	WRITE	F00092	Single	2 BYTE	1		<input checked="" type="checkbox"/>	1		Setting	Number:1 READ1:M0100,SAVE1:M100																																																																																																																																	
1												Setting																																																																																																																																		
2												Setting																																																																																																																																		
3												Setting																																																																																																																																		
4												Setting																																																																																																																																		
5												Setting																																																																																																																																		
6												Setting																																																																																																																																		
7												Setting																																																																																																																																		
6	Setting of reading operation	 <table border="1" data-bbox="472 1543 1426 1821"> <thead> <tr> <th>Index</th> <th>Ch</th> <th>Driver Setting</th> <th>P2P function</th> <th>Conditional flag</th> <th>Command type</th> <th>Data type</th> <th>No. of variables</th> <th>Data size</th> <th>Destination station</th> <th>Destination station number</th> <th>Frame</th> <th>Setting</th> <th>Variable setting contents</th> </tr> </thead> <tbody> <tr> <td>0</td> <td>1</td> <td>XGT client</td> <td>WRITE</td> <td>F00092</td> <td>Single</td> <td>2 BYTE</td> <td>1</td> <td></td> <td><input checked="" type="checkbox"/></td> <td>1</td> <td></td> <td>Setting</td> <td>Number:1 READ1:M0100,SAVE1:M100</td> </tr> <tr> <td>1</td> <td>1</td> <td>XGT client</td> <td>READ</td> <td>F00092</td> <td>Single</td> <td>2 BYTE</td> <td>1</td> <td></td> <td><input checked="" type="checkbox"/></td> <td>1</td> <td></td> <td>Setting</td> <td>Number:1 READ1:D100,SAVE1:M0110</td> </tr> <tr> <td>2</td> <td></td> <td></td> <td></td> <td></td> <td></td> <td></td> <td></td> <td></td> <td></td> <td></td> <td></td> <td>Setting</td> <td></td> </tr> <tr> <td>3</td> <td></td> <td></td> <td></td> <td></td> <td></td> <td></td> <td></td> <td></td> <td></td> <td></td> <td></td> <td>Setting</td> <td></td> </tr> <tr> <td>4</td> <td></td> <td></td> <td></td> <td></td> <td></td> <td></td> <td></td> <td></td> <td></td> <td></td> <td></td> <td>Setting</td> <td></td> </tr> <tr> <td>5</td> <td></td> <td></td> <td></td> <td></td> <td></td> <td></td> <td></td> <td></td> <td></td> <td></td> <td></td> <td>Setting</td> <td></td> </tr> <tr> <td>6</td> <td></td> <td></td> <td></td> <td></td> <td></td> <td></td> <td></td> <td></td> <td></td> <td></td> <td></td> <td>Setting</td> <td></td> </tr> <tr> <td>7</td> <td></td> <td></td> <td></td> <td></td> <td></td> <td></td> <td></td> <td></td> <td></td> <td></td> <td></td> <td>Setting</td> <td></td> </tr> <tr> <td>8</td> <td></td> <td></td> <td></td> <td></td> <td></td> <td></td> <td></td> <td></td> <td></td> <td></td> <td></td> <td>Setting</td> <td></td> </tr> </tbody> </table> <p>1. Channel, conditional flag, command type, data type, No. of variable, destination station no.: Same as described in setting is writing. 2. P2P function: select READ. 3. Setting: after setting Read area and Save area, click [OK]. 1) Read area: device address of data saved in server 2) Save area: device address of client to save</p>	Index	Ch	Driver Setting	P2P function	Conditional flag	Command type	Data type	No. of variables	Data size	Destination station	Destination station number	Frame	Setting	Variable setting contents	0	1	XGT client	WRITE	F00092	Single	2 BYTE	1		<input checked="" type="checkbox"/>	1		Setting	Number:1 READ1:M0100,SAVE1:M100	1	1	XGT client	READ	F00092	Single	2 BYTE	1		<input checked="" type="checkbox"/>	1		Setting	Number:1 READ1:D100,SAVE1:M0110	2												Setting		3												Setting		4												Setting		5												Setting		6												Setting		7												Setting		8												Setting	
Index	Ch	Driver Setting	P2P function	Conditional flag	Command type	Data type	No. of variables	Data size	Destination station	Destination station number	Frame	Setting	Variable setting contents																																																																																																																																	
0	1	XGT client	WRITE	F00092	Single	2 BYTE	1		<input checked="" type="checkbox"/>	1		Setting	Number:1 READ1:M0100,SAVE1:M100																																																																																																																																	
1	1	XGT client	READ	F00092	Single	2 BYTE	1		<input checked="" type="checkbox"/>	1		Setting	Number:1 READ1:D100,SAVE1:M0110																																																																																																																																	
2												Setting																																																																																																																																		
3												Setting																																																																																																																																		
4												Setting																																																																																																																																		
5												Setting																																																																																																																																		
6												Setting																																																																																																																																		
7												Setting																																																																																																																																		
8												Setting																																																																																																																																		

Sequence	Procedure	Setting method
7	Writing parameter	
	<ol style="list-style-type: none"> <li>1. Select [Online] – [Write] or click icon (  ).</li> <li>2. Click [OK].</li> <li>3. If writing parameter is complete After clicking [OK], changed parameter is applied automatically.</li> </ol>	
8	Enabling the link	
	<ol style="list-style-type: none"> <li>1. Select [Online] – [Communication module setting] – [Enable Link] or click icon (  ).</li> <li>2. Click the P2P to enable and click Write.</li> </ol>	

11.2.3 Checking the operation

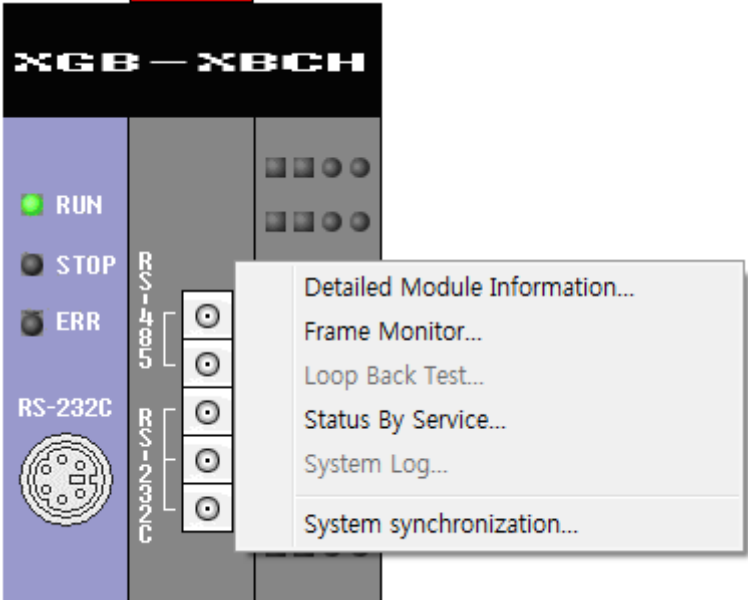
The user can analyze frame by using the frame monitor of XG5000 to check it communication is normal or not. Method of frame monitor of Cnet I/F module is same regardless of protocol.

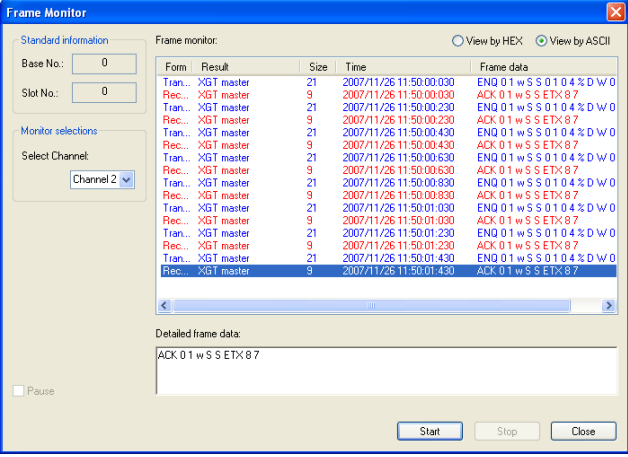
Sequence	Procedure	Setting method
1	System Diagnosis	
<p>1. Select [Online] – [Communication module setting] – [System Diagnosis] or click icon .</p> <p>2. Click the right button on the relevant module and click Frame Monitor or Status By Service to check.</p>		
2	Frame monitor	
<p>1. Select channel 2 and click Start.</p> <p>2. Since dedicated service is ASCII communication, select View by ASCII.                  * In case of Modbus RTU, select View by HEX and in case of Modbus ASCII, select View by ASCII.</p>		



### 11.3 Modbus Communication Example

We assume that system configuration of Modbus communication (Modbus RTU mode) example is as [Figure 10.3.1] and communication setting is as following table.

RS-485, 38400, 8, 1, None, Modbus RTU

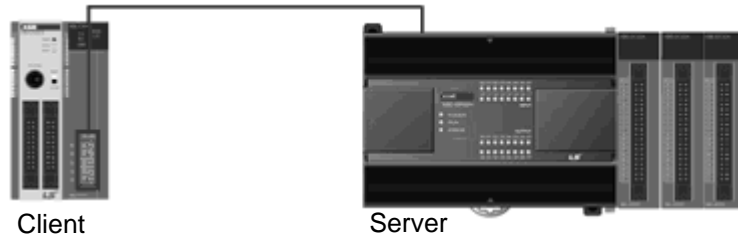

[Figure 11.3.1] XGT Modbus communication system configuration example

- Mount XBL-C41A on no. 1 slot of client PLC
- Client setting

Main unit		XBM-DN32S
Communication module		XBL-C41A(no.1 Slot)
Communication type		RS-485
Communication speed		38,400
Data bit		8
Stop bit		1
Parity bit		None
Operation cycle		200ms
Operation status	Write	<ul style="list-style-type: none"> <li>▶ Write 1 word of M100 of client to M1 of server</li> <li>▶ Write 4 words from D0 of client to M2~M5 of server</li> <li>▶ Write 15<sup>th</sup> bit of M2 to 2<sup>nd</sup> bit of M20 of server</li> <li>▶ Write 0~15<sup>th</sup> bit of M2 to 0~15<sup>th</sup> bit of M21 of server</li> </ul>
	Read	<ul style="list-style-type: none"> <li>▶ Read 1 word of M2 of server and save it at M160 of client</li> <li>▶ Read 4 words from P0 of server and save it at M150~M153</li> <li>▶ Read 1<sup>st</sup> bit of P2 of server and save it at 1<sup>st</sup> bit of M170.</li> <li>▶ Read 0<sup>th</sup> ~ 15<sup>th</sup> bit of M10 of server and save it at 0<sup>th</sup> ~ 15<sup>th</sup> of M180 of client.</li> </ul>

[Table 11.3.1] client setting

- Server setting



Main unit		XBC-DN32H
Communication type		Built-in RS-485
Communication speed		38,400
Data bit		8
Stop bit		1
Parity bit		None
Station no.		1
Start address	Bit read area Address	P0
	Bit write area Address	M0
	Word write area Address	P0
	Word write area Address	M0

[Table 11.3.2] server setting

11.3.1 Modbus RTU server setting

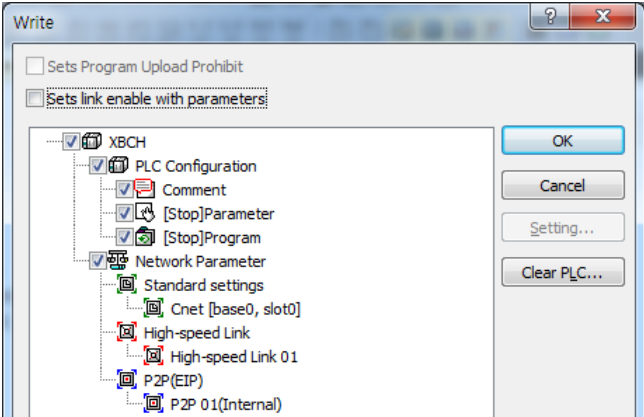

Standard settings are as follows to act built-in RS-485 communication channel of XBC-DN32H as Modbus RTU server.

Sequence	Procedure	Setting method
1	Connection setting	
		<ol style="list-style-type: none"> <li>1. Select [Online]-[Connection Settings] or click icon</li> <li>2. Click [Connect] after setting.</li> </ol>
2	Reading IO information	Select [Online] – [Diagnosis] – [I/O Information] and click [I/O Sync] Reads the information about currently equipped module.
3	Standard settings	
		<ol style="list-style-type: none"> <li>1. Write setting value as same with [Table 11.3.2] at built-in communication channel 1.</li> <li>2. Set active mode as Modbus RTU server.</li> </ol>
4	Modbus setting	
		<ol style="list-style-type: none"> <li>1. Bit read area Address: P00000</li> <li>2. Bit write area Address: M0000</li> <li>3. Word read area Address: P0000</li> <li>4. Word write area Address: M0000</li> </ol> <p>* In the Bit read/write area Address, upper 4 digit is word address and the last digit is bit address (P00110: 0<sup>th</sup> bit of P11<sup>th</sup> word)</p>

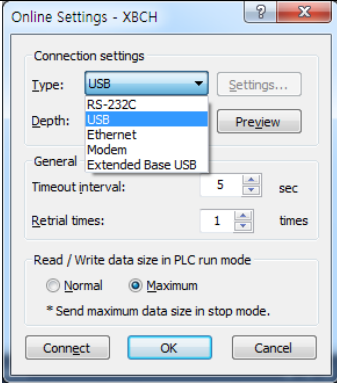

Sequence	Procedure	Setting method
5	Writing parameter	
		<ol style="list-style-type: none"> <li>1. Select [Online] – [Write] or click icon (  ).</li> <li>2. Click [OK].</li> <li>3. If writing parameter is complete After clicking [OK], changed parameter is applied automatically.</li> </ol>

11.3.2 Setting of Modbus RTU client

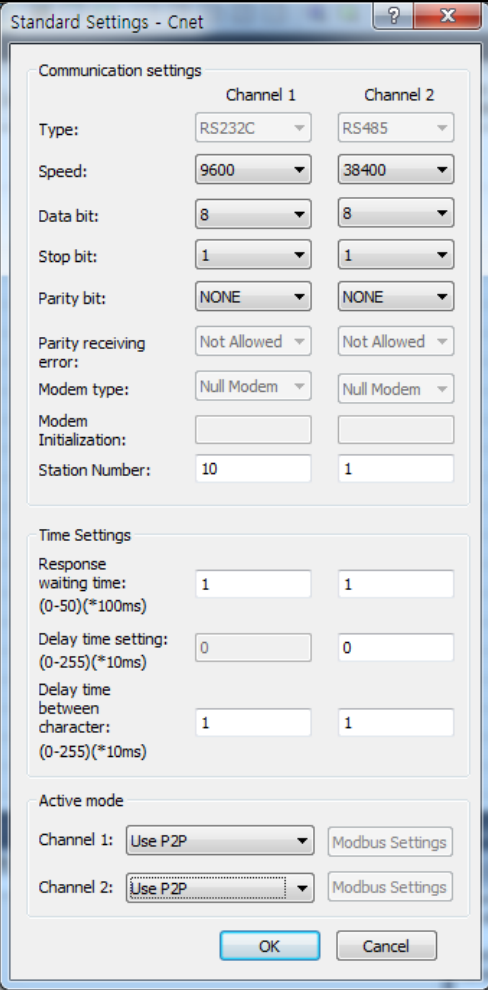
Standard settings are as follows to act XBL-C41A of client as Modbus RTU client.

Sequence	Procedure	Setting method
1	Connection setting	
		<ol style="list-style-type: none"> <li>1. Select [Online]-[Connection Settings] or click icon()</li> <li>2. Click [Connect] after setting.</li> </ol>
2	Reading IO information	Select [Online] – [Diagnosis] – [I/O Information] and click [I/O Sync] Reads the information about currently equipped module.
3	Standard settings	
		<ol style="list-style-type: none"> <li>1. Select XBL-C41A and write standard settings to be same with [Table 11.3.1] at channel</li> <li>2. Since station setting doesn't have meaning when acting as client, set as temporary station number (0~255).</li> <li>3. When acting as client mode, active mode should be Use P2P settings.</li> </ol>

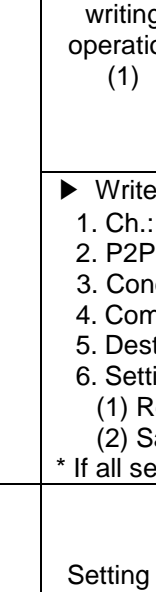
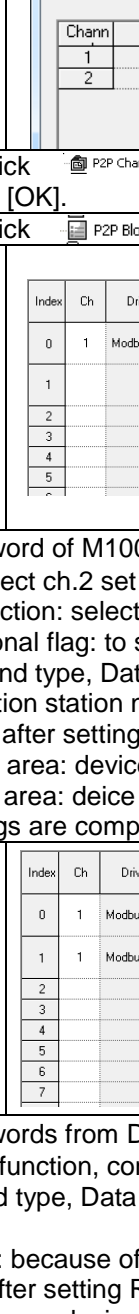

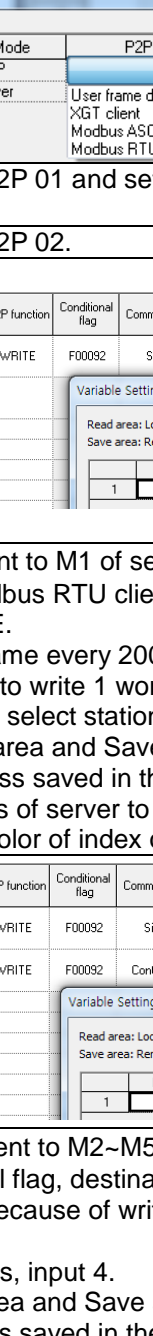
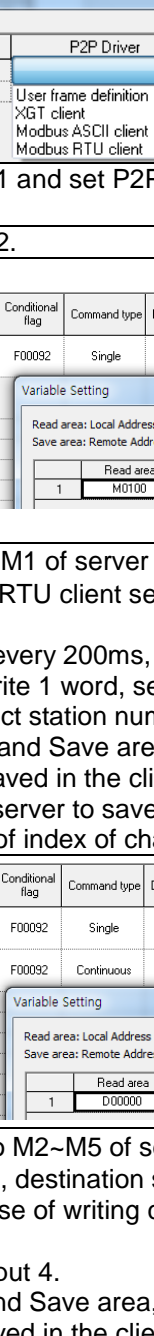

After standard settings, P2P channel and P2P block should be set. Setting methods are as follows.

Sequence	Procedure	Setting method
1	P2P setting	Click  P2P bottom of project tree
2	Communication module setting	 <p>1. Right click PLC and select [Add Item] – [P2P Communication] 2. Select slot number acting as client and press OK.</p>
3	P2P channel setting	 <p>1. Double-click  of P2P 01 and set P2P driver of channel 1 as Modbus RTU client and click [OK].</p>
4		1. Double-click  of P2P 02.
5	Setting of writing operation (1)	 <p>► Write 1 word of M100 of client to M1 of server</p> <ol style="list-style-type: none"> <li>Ch.: Select ch.2 set as Modbus RTU client set in P2P channel.</li> <li>P2P function: select WRITE.</li> <li>Conditional flag: to send frame every 200ms, use flag F92.</li> <li>Command type, Data type: to write 1 word, select single and WORD.</li> <li>Destination station number: select station number of server.</li> <li>Setting: after setting Read area and Save area, click OK.                     <ol style="list-style-type: none"> <li>Read area: device address saved in the client (M100)</li> <li>Save area: deice address of server to save (0x40001: M1)</li> </ol> </li> </ol> <p>* If all settings are completed, color of index of channel becomes black.</p>
6	Setting of writing operation (2)	 <p>► Write 4 words from D0 of client to M2~M5 of server</p> <ol style="list-style-type: none"> <li>Ch., P2P function, conditional flag, destination station no.: same with step 5</li> <li>Command type, Data type: because of writing continuous 4words, select Continuous, WORD</li> <li>Data size: because of 4 words, input 4.</li> <li>Setting: after setting Read area and Save area, click OK.                     <ol style="list-style-type: none"> <li>Read area: device address saved in the client (D0)</li> <li>Save area: deice address of server to save (0x40002 : M2)</li> </ol> </li> </ol>

# Chapter 11 Example program

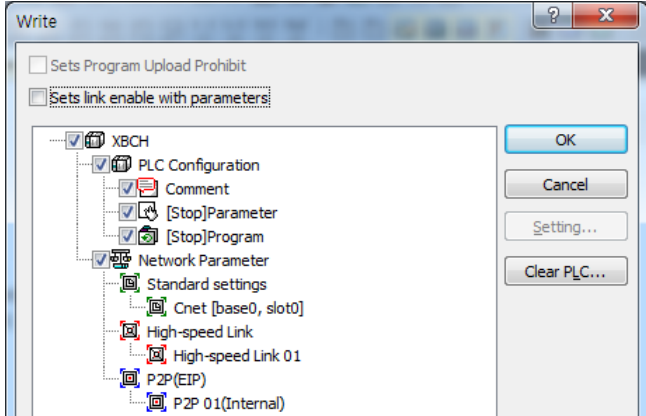
Sequence	Procedure	Setting method																																																																																																																																																																								
7	Setting of writing operation (3)	<table border="1"> <thead> <tr> <th>Index</th> <th>Ch</th> <th>Driver Setting</th> <th>P2P function</th> <th>Conditional flag</th> <th>Command type</th> <th>Data type</th> <th>No. of variables</th> <th>Data size</th> <th>Destination station</th> <th>Destination station number</th> <th>Frame</th> <th>Setting</th> <th>Variable setting contents</th> </tr> </thead> <tbody> <tr> <td>0</td> <td>1</td> <td>Modbus RTU client</td> <td>WRITE</td> <td>F0092</td> <td>Single</td> <td>WORD</td> <td>1</td> <td></td> <td><input checked="" type="checkbox"/></td> <td>1</td> <td></td> <td>Setting</td> <td>Number:1 READ1:M0100,SAVE1:0x40001</td> </tr> <tr> <td>1</td> <td>1</td> <td>Modbus RTU client</td> <td>WRITE</td> <td>F0092</td> <td>Continuous</td> <td>WORD</td> <td>1</td> <td>4</td> <td><input checked="" type="checkbox"/></td> <td>1</td> <td></td> <td>Setting</td> <td>Number:1 READ1:D00000,SAVE1:0x40002</td> </tr> <tr> <td>2</td> <td>1</td> <td>Modbus RTU client</td> <td>WRITE</td> <td>F0092</td> <td>Single</td> <td>BIT</td> <td>1</td> <td></td> <td><input checked="" type="checkbox"/></td> <td>1</td> <td></td> <td>Setting</td> <td>Number:1 READ1:M0001F,SAVE1:0x00142</td> </tr> <tr> <td>3</td> <td></td> <td></td> <td></td> <td></td> <td></td> <td></td> <td></td> <td></td> <td></td> <td></td> <td></td> <td>Setting</td> <td></td> </tr> <tr> <td>4</td> <td></td> <td></td> <td></td> <td></td> <td></td> <td></td> <td></td> <td></td> <td></td> <td></td> <td></td> <td>Setting</td> <td></td> </tr> <tr> <td>5</td> <td></td> <td></td> <td></td> <td></td> <td></td> <td></td> <td></td> <td></td> <td></td> <td></td> <td></td> <td>Setting</td> <td></td> </tr> <tr> <td>6</td> <td></td> <td></td> <td></td> <td></td> <td></td> <td></td> <td></td> <td></td> <td></td> <td></td> <td></td> <td>Setting</td> <td></td> </tr> <tr> <td>7</td> <td></td> <td></td> <td></td> <td></td> <td></td> <td></td> <td></td> <td></td> <td></td> <td></td> <td></td> <td>Setting</td> <td></td> </tr> <tr> <td>8</td> <td></td> <td></td> <td></td> <td></td> <td></td> <td></td> <td></td> <td></td> <td></td> <td></td> <td></td> <td>Setting</td> <td></td> </tr> <tr> <td>9</td> <td></td> <td></td> <td></td> <td></td> <td></td> <td></td> <td></td> <td></td> <td></td> <td></td> <td></td> <td>Setting</td> <td></td> </tr> <tr> <td>10</td> <td></td> <td></td> <td></td> <td></td> <td></td> <td></td> <td></td> <td></td> <td></td> <td></td> <td></td> <td>Setting</td> <td></td> </tr> </tbody> </table> <p> <b>► Write 15<sup>th</sup> bit of M2 to 2<sup>nd</sup> bit of M20 of server</b>            1. Ch., P2P function, conditional flag, destination station no.: same with step 5            2. Data type: select bit            3. Setting: after setting Read area and Save area, click OK.                (1) Read area: device address saved in the client (M0001F : 15<sup>th</sup> bit of M1)                (2) Save area: device address of server to save (0x00142: 2<sup>nd</sup> bit of M20)            * When inputting M1.F, it is converted into M0001F in the XG5000.            * Device address of server is Hex value.         </p>	Index	Ch	Driver Setting	P2P function	Conditional flag	Command type	Data type	No. of variables	Data size	Destination station	Destination station number	Frame	Setting	Variable setting contents	0	1	Modbus RTU client	WRITE	F0092	Single	WORD	1		<input checked="" type="checkbox"/>	1		Setting	Number:1 READ1:M0100,SAVE1:0x40001	1	1	Modbus RTU client	WRITE	F0092	Continuous	WORD	1	4	<input checked="" type="checkbox"/>	1		Setting	Number:1 READ1:D00000,SAVE1:0x40002	2	1	Modbus RTU client	WRITE	F0092	Single	BIT	1		<input checked="" type="checkbox"/>	1		Setting	Number:1 READ1:M0001F,SAVE1:0x00142	3												Setting		4												Setting		5												Setting		6												Setting		7												Setting		8												Setting		9												Setting		10												Setting	
		Index	Ch	Driver Setting	P2P function	Conditional flag	Command type	Data type	No. of variables	Data size	Destination station	Destination station number	Frame	Setting	Variable setting contents																																																																																																																																																											
0	1	Modbus RTU client	WRITE	F0092	Single	WORD	1		<input checked="" type="checkbox"/>	1		Setting	Number:1 READ1:M0100,SAVE1:0x40001																																																																																																																																																													
1	1	Modbus RTU client	WRITE	F0092	Continuous	WORD	1	4	<input checked="" type="checkbox"/>	1		Setting	Number:1 READ1:D00000,SAVE1:0x40002																																																																																																																																																													
2	1	Modbus RTU client	WRITE	F0092	Single	BIT	1		<input checked="" type="checkbox"/>	1		Setting	Number:1 READ1:M0001F,SAVE1:0x00142																																																																																																																																																													
3												Setting																																																																																																																																																														
4												Setting																																																																																																																																																														
5												Setting																																																																																																																																																														
6												Setting																																																																																																																																																														
7												Setting																																																																																																																																																														
8												Setting																																																																																																																																																														
9												Setting																																																																																																																																																														
10												Setting																																																																																																																																																														
8	Setting of writing operation (4)	<table border="1"> <thead> <tr> <th>Index</th> <th>Ch</th> <th>Driver Setting</th> <th>P2P function</th> <th>Conditional flag</th> <th>Command type</th> <th>Data type</th> <th>No. of variables</th> <th>Data size</th> <th>Destination station</th> <th>Destination station number</th> <th>Frame</th> <th>Setting</th> <th>Variable setting contents</th> </tr> </thead> <tbody> <tr> <td>3</td> <td>1</td> <td>Modbus RTU client</td> <td>WRITE</td> <td>F0092</td> <td>Continuous</td> <td>BIT</td> <td>1</td> <td>16</td> <td><input checked="" type="checkbox"/></td> <td>1</td> <td></td> <td>Setting</td> <td>Number:1 READ1:M00020,SAVE1:0x00150</td> </tr> <tr> <td>4</td> <td></td> <td></td> <td></td> <td></td> <td></td> <td></td> <td></td> <td></td> <td></td> <td></td> <td></td> <td>Setting</td> <td></td> </tr> <tr> <td>5</td> <td></td> <td></td> <td></td> <td></td> <td></td> <td></td> <td></td> <td></td> <td></td> <td></td> <td></td> <td>Setting</td> <td></td> </tr> <tr> <td>6</td> <td></td> <td></td> <td></td> <td></td> <td></td> <td></td> <td></td> <td></td> <td></td> <td></td> <td></td> <td>Setting</td> <td></td> </tr> <tr> <td>7</td> <td></td> <td></td> <td></td> <td></td> <td></td> <td></td> <td></td> <td></td> <td></td> <td></td> <td></td> <td>Setting</td> <td></td> </tr> <tr> <td>8</td> <td></td> <td></td> <td></td> <td></td> <td></td> <td></td> <td></td> <td></td> <td></td> <td></td> <td></td> <td>Setting</td> <td></td> </tr> <tr> <td>9</td> <td></td> <td></td> <td></td> <td></td> <td></td> <td></td> <td></td> <td></td> <td></td> <td></td> <td></td> <td>Setting</td> <td></td> </tr> <tr> <td>10</td> <td></td> <td></td> <td></td> <td></td> <td></td> <td></td> <td></td> <td></td> <td></td> <td></td> <td></td> <td>Setting</td> <td></td> </tr> </tbody> </table> <p> <b>► Write 0~15<sup>th</sup> bit of M2 to 0~15<sup>th</sup> bit of M21 of server</b>            1. Ch., P2P function, conditional flag, destination station no.: same with step 7            2. Command type: select continuous.            3. Setting: after setting Read area and Save area, click OK.                (1) Read area: device address saved in the client (M00020)                (2) Save area: device address of server to save (0x00150)         </p>	Index	Ch	Driver Setting	P2P function	Conditional flag	Command type	Data type	No. of variables	Data size	Destination station	Destination station number	Frame	Setting	Variable setting contents	3	1	Modbus RTU client	WRITE	F0092	Continuous	BIT	1	16	<input checked="" type="checkbox"/>	1		Setting	Number:1 READ1:M00020,SAVE1:0x00150	4												Setting		5												Setting		6												Setting		7												Setting		8												Setting		9												Setting		10												Setting																																											
		Index	Ch	Driver Setting	P2P function	Conditional flag	Command type	Data type	No. of variables	Data size	Destination station	Destination station number	Frame	Setting	Variable setting contents																																																																																																																																																											
3	1	Modbus RTU client	WRITE	F0092	Continuous	BIT	1	16	<input checked="" type="checkbox"/>	1		Setting	Number:1 READ1:M00020,SAVE1:0x00150																																																																																																																																																													
4												Setting																																																																																																																																																														
5												Setting																																																																																																																																																														
6												Setting																																																																																																																																																														
7												Setting																																																																																																																																																														
8												Setting																																																																																																																																																														
9												Setting																																																																																																																																																														
10												Setting																																																																																																																																																														
9	Setting of reading operation (1)	<table border="1"> <thead> <tr> <th>Index</th> <th>Ch</th> <th>Driver Setting</th> <th>P2P function</th> <th>Conditional flag</th> <th>Command type</th> <th>Data type</th> <th>No. of variables</th> <th>Data size</th> <th>Destination station</th> <th>Destination station number</th> <th>Frame</th> <th>Setting</th> <th>Variable setting contents</th> </tr> </thead> <tbody> <tr> <td>3</td> <td>1</td> <td>Modbus RTU client</td> <td>WRITE</td> <td>F0092</td> <td>Continuous</td> <td>BIT</td> <td>1</td> <td>16</td> <td><input checked="" type="checkbox"/></td> <td>1</td> <td></td> <td>Setting</td> <td>Number:1 READ1:M00020,SAVE1:0x00150</td> </tr> <tr> <td>4</td> <td>1</td> <td>Modbus RTU client</td> <td>READ</td> <td>F0092</td> <td>Single</td> <td>WORD</td> <td>1</td> <td></td> <td><input checked="" type="checkbox"/></td> <td>1</td> <td></td> <td>Setting</td> <td>Number:1 READ1:0x30002,SAVE1:M0160</td> </tr> <tr> <td>5</td> <td></td> <td></td> <td></td> <td></td> <td></td> <td></td> <td></td> <td></td> <td></td> <td></td> <td></td> <td>Setting</td> <td></td> </tr> <tr> <td>6</td> <td></td> <td></td> <td></td> <td></td> <td></td> <td></td> <td></td> <td></td> <td></td> <td></td> <td></td> <td>Setting</td> <td></td> </tr> <tr> <td>7</td> <td></td> <td></td> <td></td> <td></td> <td></td> <td></td> <td></td> <td></td> <td></td> <td></td> <td></td> <td>Setting</td> <td></td> </tr> <tr> <td>8</td> <td></td> <td></td> <td></td> <td></td> <td></td> <td></td> <td></td> <td></td> <td></td> <td></td> <td></td> <td>Setting</td> <td></td> </tr> <tr> <td>9</td> <td></td> <td></td> <td></td> <td></td> <td></td> <td></td> <td></td> <td></td> <td></td> <td></td> <td></td> <td>Setting</td> <td></td> </tr> <tr> <td>10</td> <td></td> <td></td> <td></td> <td></td> <td></td> <td></td> <td></td> <td></td> <td></td> <td></td> <td></td> <td>Setting</td> <td></td> </tr> <tr> <td>11</td> <td></td> <td></td> <td></td> <td></td> <td></td> <td></td> <td></td> <td></td> <td></td> <td></td> <td></td> <td>Setting</td> <td></td> </tr> </tbody> </table> <p> <b>► Read 1 word of M2 of server and save it at M160 of client</b>            1. Ch., Conditional flag, Command type, Data type, Destination station no.: same with step 5            2. P2P function: select READ            3. Setting: after setting Read area and Save area, click OK.                (1) Read area: device address saved in server (0x30002)                (2) Save area: device address of client to save (M0160)         </p>	Index	Ch	Driver Setting	P2P function	Conditional flag	Command type	Data type	No. of variables	Data size	Destination station	Destination station number	Frame	Setting	Variable setting contents	3	1	Modbus RTU client	WRITE	F0092	Continuous	BIT	1	16	<input checked="" type="checkbox"/>	1		Setting	Number:1 READ1:M00020,SAVE1:0x00150	4	1	Modbus RTU client	READ	F0092	Single	WORD	1		<input checked="" type="checkbox"/>	1		Setting	Number:1 READ1:0x30002,SAVE1:M0160	5												Setting		6												Setting		7												Setting		8												Setting		9												Setting		10												Setting		11												Setting																													
		Index	Ch	Driver Setting	P2P function	Conditional flag	Command type	Data type	No. of variables	Data size	Destination station	Destination station number	Frame	Setting	Variable setting contents																																																																																																																																																											
3	1	Modbus RTU client	WRITE	F0092	Continuous	BIT	1	16	<input checked="" type="checkbox"/>	1		Setting	Number:1 READ1:M00020,SAVE1:0x00150																																																																																																																																																													
4	1	Modbus RTU client	READ	F0092	Single	WORD	1		<input checked="" type="checkbox"/>	1		Setting	Number:1 READ1:0x30002,SAVE1:M0160																																																																																																																																																													
5												Setting																																																																																																																																																														
6												Setting																																																																																																																																																														
7												Setting																																																																																																																																																														
8												Setting																																																																																																																																																														
9												Setting																																																																																																																																																														
10												Setting																																																																																																																																																														
11												Setting																																																																																																																																																														

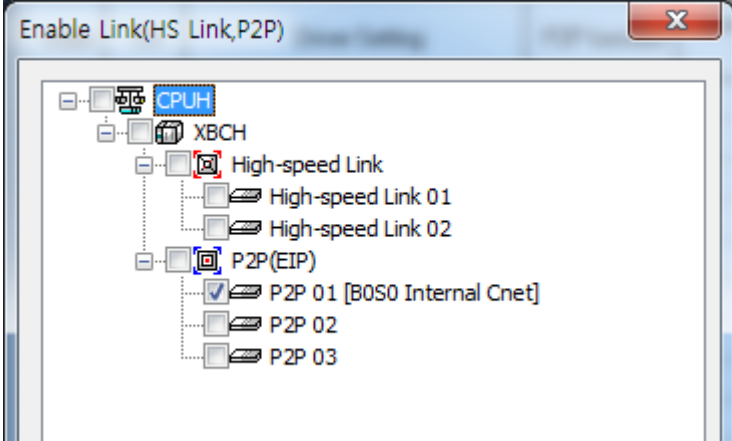
Sequence	Procedure	Setting method																																																																																																																																																										
10	Setting of reading operation (2)	<table border="1"> <thead> <tr> <th>Index</th> <th>Ch</th> <th>Driver Setting</th> <th>P2P function</th> <th>Conditional flag</th> <th>Command type</th> <th>Data type</th> <th>No. of variables</th> <th>Data size</th> <th>Destination station</th> <th>Destination station number</th> <th>Frame</th> <th>Setting</th> <th>Variable setting contents</th> </tr> </thead> <tbody> <tr> <td>3</td> <td>1</td> <td>Modbus RTU client</td> <td>WRITE</td> <td>F00092</td> <td>Continuous</td> <td>BIT</td> <td>1</td> <td>16</td> <td><input checked="" type="checkbox"/></td> <td>1</td> <td></td> <td>Setting</td> <td>Number:1 READ1:M00020.SAVE1:0x00150</td> </tr> <tr> <td>4</td> <td>1</td> <td>Modbus RTU client</td> <td>READ</td> <td>F00092</td> <td>Single</td> <td>WORD</td> <td>1</td> <td></td> <td><input checked="" type="checkbox"/></td> <td>1</td> <td></td> <td>Setting</td> <td>Number:1 READ1:0x30002.SAVE1:M0150</td> </tr> <tr> <td>5</td> <td>1</td> <td>Modbus RTU client</td> <td>READ</td> <td>F00092</td> <td>Continuous</td> <td>WORD</td> <td>1</td> <td>4</td> <td><input checked="" type="checkbox"/></td> <td>1</td> <td></td> <td>Setting</td> <td>Number:1 READ1:0x30000.SAVE1:M0150</td> </tr> <tr> <td>6</td> <td></td> <td></td> <td></td> <td></td> <td></td> <td></td> <td></td> <td></td> <td></td> <td></td> <td></td> <td>Setting</td> <td></td> </tr> <tr> <td>7</td> <td></td> <td></td> <td></td> <td></td> <td></td> <td></td> <td></td> <td></td> <td></td> <td></td> <td></td> <td>Setting</td> <td></td> </tr> <tr> <td>8</td> <td></td> <td></td> <td></td> <td></td> <td></td> <td></td> <td></td> <td></td> <td></td> <td></td> <td></td> <td>Setting</td> <td></td> </tr> <tr> <td>9</td> <td></td> <td></td> <td></td> <td></td> <td></td> <td></td> <td></td> <td></td> <td></td> <td></td> <td></td> <td>Setting</td> <td></td> </tr> <tr> <td>10</td> <td></td> <td></td> <td></td> <td></td> <td></td> <td></td> <td></td> <td></td> <td></td> <td></td> <td></td> <td>Setting</td> <td></td> </tr> <tr> <td>11</td> <td></td> <td></td> <td></td> <td></td> <td></td> <td></td> <td></td> <td></td> <td></td> <td></td> <td></td> <td>Setting</td> <td></td> </tr> <tr> <td>12</td> <td></td> <td></td> <td></td> <td></td> <td></td> <td></td> <td></td> <td></td> <td></td> <td></td> <td></td> <td>Setting</td> <td></td> </tr> </tbody> </table> <p> <b>► Read 4 words from P0 of server and save it at M150~M153</b>                      1. Ch., Conditional flag, Command type, Data type, Destination station no.: same with step 6                      2. P2P function: select READ.                      3. Setting: after setting Read area and Save area, click OK.                      (1) Read area: device address saved in server (0x30000)                      (2) Save area: device address of client to save (M0150)                 </p>	Index	Ch	Driver Setting	P2P function	Conditional flag	Command type	Data type	No. of variables	Data size	Destination station	Destination station number	Frame	Setting	Variable setting contents	3	1	Modbus RTU client	WRITE	F00092	Continuous	BIT	1	16	<input checked="" type="checkbox"/>	1		Setting	Number:1 READ1:M00020.SAVE1:0x00150	4	1	Modbus RTU client	READ	F00092	Single	WORD	1		<input checked="" type="checkbox"/>	1		Setting	Number:1 READ1:0x30002.SAVE1:M0150	5	1	Modbus RTU client	READ	F00092	Continuous	WORD	1	4	<input checked="" type="checkbox"/>	1		Setting	Number:1 READ1:0x30000.SAVE1:M0150	6												Setting		7												Setting		8												Setting		9												Setting		10												Setting		11												Setting		12												Setting	
		Index	Ch	Driver Setting	P2P function	Conditional flag	Command type	Data type	No. of variables	Data size	Destination station	Destination station number	Frame	Setting	Variable setting contents																																																																																																																																													
3	1	Modbus RTU client	WRITE	F00092	Continuous	BIT	1	16	<input checked="" type="checkbox"/>	1		Setting	Number:1 READ1:M00020.SAVE1:0x00150																																																																																																																																															
4	1	Modbus RTU client	READ	F00092	Single	WORD	1		<input checked="" type="checkbox"/>	1		Setting	Number:1 READ1:0x30002.SAVE1:M0150																																																																																																																																															
5	1	Modbus RTU client	READ	F00092	Continuous	WORD	1	4	<input checked="" type="checkbox"/>	1		Setting	Number:1 READ1:0x30000.SAVE1:M0150																																																																																																																																															
6												Setting																																																																																																																																																
7												Setting																																																																																																																																																
8												Setting																																																																																																																																																
9												Setting																																																																																																																																																
10												Setting																																																																																																																																																
11												Setting																																																																																																																																																
12												Setting																																																																																																																																																
11	Setting of reading operation (3)	<table border="1"> <thead> <tr> <th>Index</th> <th>Ch</th> <th>Driver Setting</th> <th>P2P function</th> <th>Conditional flag</th> <th>Command type</th> <th>Data type</th> <th>No. of variables</th> <th>Data size</th> <th>Destination station</th> <th>Destination station number</th> <th>Frame</th> <th>Setting</th> <th>Variable setting contents</th> </tr> </thead> <tbody> <tr> <td>6</td> <td>1</td> <td>Modbus RTU client</td> <td>READ</td> <td>F00092</td> <td>Single</td> <td>BIT</td> <td>1</td> <td></td> <td><input checked="" type="checkbox"/></td> <td>1</td> <td></td> <td>Setting</td> <td>Number:1 READ1:0x10021.SAVE1:M01701</td> </tr> <tr> <td>7</td> <td></td> <td></td> <td></td> <td></td> <td></td> <td></td> <td></td> <td></td> <td></td> <td></td> <td></td> <td>Setting</td> <td></td> </tr> <tr> <td>8</td> <td></td> <td></td> <td></td> <td></td> <td></td> <td></td> <td></td> <td></td> <td></td> <td></td> <td></td> <td>Setting</td> <td></td> </tr> <tr> <td>9</td> <td></td> <td></td> <td></td> <td></td> <td></td> <td></td> <td></td> <td></td> <td></td> <td></td> <td></td> <td>Setting</td> <td></td> </tr> <tr> <td>10</td> <td></td> <td></td> <td></td> <td></td> <td></td> <td></td> <td></td> <td></td> <td></td> <td></td> <td></td> <td>Setting</td> <td></td> </tr> <tr> <td>11</td> <td></td> <td></td> <td></td> <td></td> <td></td> <td></td> <td></td> <td></td> <td></td> <td></td> <td></td> <td>Setting</td> <td></td> </tr> <tr> <td>12</td> <td></td> <td></td> <td></td> <td></td> <td></td> <td></td> <td></td> <td></td> <td></td> <td></td> <td></td> <td>Setting</td> <td></td> </tr> <tr> <td>13</td> <td></td> <td></td> <td></td> <td></td> <td></td> <td></td> <td></td> <td></td> <td></td> <td></td> <td></td> <td>Setting</td> <td></td> </tr> </tbody> </table> <p> <b>► Read 1<sup>st</sup> bit of P2 of server and save it at 1<sup>st</sup> bit of M170.</b>                      1. Ch., Conditional flag, Command type, Data type, Destination station no.: same with step 7                      2. P2P function: select READ                      3. Setting: after setting Read area and Save area, click OK.                      (1) Read area: device address saved in server (0x10021)                      (2) Save area: device address of client to save (M01701)                 </p>	Index	Ch	Driver Setting	P2P function	Conditional flag	Command type	Data type	No. of variables	Data size	Destination station	Destination station number	Frame	Setting	Variable setting contents	6	1	Modbus RTU client	READ	F00092	Single	BIT	1		<input checked="" type="checkbox"/>	1		Setting	Number:1 READ1:0x10021.SAVE1:M01701	7												Setting		8												Setting		9												Setting		10												Setting		11												Setting		12												Setting		13												Setting																													
		Index	Ch	Driver Setting	P2P function	Conditional flag	Command type	Data type	No. of variables	Data size	Destination station	Destination station number	Frame	Setting	Variable setting contents																																																																																																																																													
6	1	Modbus RTU client	READ	F00092	Single	BIT	1		<input checked="" type="checkbox"/>	1		Setting	Number:1 READ1:0x10021.SAVE1:M01701																																																																																																																																															
7												Setting																																																																																																																																																
8												Setting																																																																																																																																																
9												Setting																																																																																																																																																
10												Setting																																																																																																																																																
11												Setting																																																																																																																																																
12												Setting																																																																																																																																																
13												Setting																																																																																																																																																
12	Setting of reading operation (4)	<table border="1"> <thead> <tr> <th>Index</th> <th>Ch</th> <th>Driver Setting</th> <th>P2P function</th> <th>Conditional flag</th> <th>Command type</th> <th>Data type</th> <th>No. of variables</th> <th>Data size</th> <th>Destination station</th> <th>Destination station number</th> <th>Frame</th> <th>Setting</th> <th>Variable setting contents</th> </tr> </thead> <tbody> <tr> <td>6</td> <td>1</td> <td>Modbus RTU client</td> <td>READ</td> <td>F00092</td> <td>Single</td> <td>BIT</td> <td>1</td> <td></td> <td><input checked="" type="checkbox"/></td> <td>1</td> <td></td> <td>Setting</td> <td>Number:1 READ1:0x10021.SAVE1:M01701</td> </tr> <tr> <td>7</td> <td>1</td> <td>Modbus RTU client</td> <td>READ</td> <td>F00092</td> <td>Continuous</td> <td>BIT</td> <td>1</td> <td>16</td> <td><input checked="" type="checkbox"/></td> <td>1</td> <td></td> <td>Setting</td> <td>Number:1 READ1:0x100A0.SAVE1:M01800</td> </tr> <tr> <td>8</td> <td></td> <td></td> <td></td> <td></td> <td></td> <td></td> <td></td> <td></td> <td></td> <td></td> <td></td> <td>Setting</td> <td></td> </tr> <tr> <td>9</td> <td></td> <td></td> <td></td> <td></td> <td></td> <td></td> <td></td> <td></td> <td></td> <td></td> <td></td> <td>Setting</td> <td></td> </tr> <tr> <td>10</td> <td></td> <td></td> <td></td> <td></td> <td></td> <td></td> <td></td> <td></td> <td></td> <td></td> <td></td> <td>Setting</td> <td></td> </tr> <tr> <td>11</td> <td></td> <td></td> <td></td> <td></td> <td></td> <td></td> <td></td> <td></td> <td></td> <td></td> <td></td> <td>Setting</td> <td></td> </tr> <tr> <td>12</td> <td></td> <td></td> <td></td> <td></td> <td></td> <td></td> <td></td> <td></td> <td></td> <td></td> <td></td> <td>Setting</td> <td></td> </tr> <tr> <td>13</td> <td></td> <td></td> <td></td> <td></td> <td></td> <td></td> <td></td> <td></td> <td></td> <td></td> <td></td> <td>Setting</td> <td></td> </tr> <tr> <td>14</td> <td></td> <td></td> <td></td> <td></td> <td></td> <td></td> <td></td> <td></td> <td></td> <td></td> <td></td> <td>Setting</td> <td></td> </tr> </tbody> </table> <p> <b>► Read 0<sup>th</sup> ~ 15<sup>th</sup> bit of M10 of server and save it at 0<sup>th</sup> ~ 15<sup>th</sup> of M180 of client.</b>                      1. Ch., Conditional flag, Command type, Data type, Destination station no.: same with step 8                      2. P2P function: select READ                      3. Setting: after setting Read area and Save area, click OK.                      (1) Read area: device address saved in server (0x100A0)                      (2) Save area: device address of client to save (M01800)                 </p>	Index	Ch	Driver Setting	P2P function	Conditional flag	Command type	Data type	No. of variables	Data size	Destination station	Destination station number	Frame	Setting	Variable setting contents	6	1	Modbus RTU client	READ	F00092	Single	BIT	1		<input checked="" type="checkbox"/>	1		Setting	Number:1 READ1:0x10021.SAVE1:M01701	7	1	Modbus RTU client	READ	F00092	Continuous	BIT	1	16	<input checked="" type="checkbox"/>	1		Setting	Number:1 READ1:0x100A0.SAVE1:M01800	8												Setting		9												Setting		10												Setting		11												Setting		12												Setting		13												Setting		14												Setting															
		Index	Ch	Driver Setting	P2P function	Conditional flag	Command type	Data type	No. of variables	Data size	Destination station	Destination station number	Frame	Setting	Variable setting contents																																																																																																																																													
6	1	Modbus RTU client	READ	F00092	Single	BIT	1		<input checked="" type="checkbox"/>	1		Setting	Number:1 READ1:0x10021.SAVE1:M01701																																																																																																																																															
7	1	Modbus RTU client	READ	F00092	Continuous	BIT	1	16	<input checked="" type="checkbox"/>	1		Setting	Number:1 READ1:0x100A0.SAVE1:M01800																																																																																																																																															
8												Setting																																																																																																																																																
9												Setting																																																																																																																																																
10												Setting																																																																																																																																																
11												Setting																																																																																																																																																
12												Setting																																																																																																																																																
13												Setting																																																																																																																																																
14												Setting																																																																																																																																																

Sequence	Procedure	Setting method
13	Writing parameter	
<ol style="list-style-type: none"> <li>1. Select [Online] – [Write] or click icon (  ).</li> <li>2. Click [OK].</li> <li>3. If writing parameter is complete After clicking [OK], changed parameter is applied automatically.</li> </ol>		
14	Enabling the link	
<ol style="list-style-type: none"> <li>1. Select [Online] – [Communication module setting] – [Enable Link] or click icon (  ).</li> <li>2. Click the P2P to enable and click Write.</li> </ol>		



## 11.4 User - defined Communication Example

### 11.4.1 User-defined communication example system configuration

When communication with device of which protocol is not supported by Cnet I/F module client, how to use user-defined communication is described in the system like [Figure 10.4.1] below

- System configuration

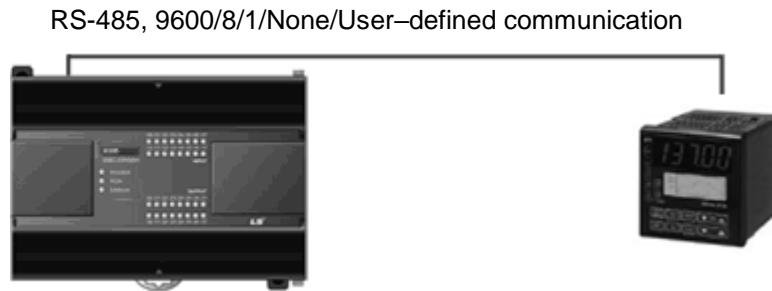

[Figure 11.4.1] User defined communication system configuration

At this example, Cnet I/F module and partner device to communicate through user defined communication system configuration are as [Table 11.4.1].

Device name	Main unit	XBC-DN32H	Han-Young temperature controller PX7* <sup>Note2)</sup>
	Communication module	Built-in RS-485	
Operation mode	Client		Server
Protocol	User frame definition		PC Link
Communication type	RS-485		RS-485
Communication speed	9,600		9,600
Data bit	8		8
Stop bit	1		1
Parity bit	None		None
Station no.	0		1
Delay time <sup>*note1)</sup>	100ms		-
Operation	Reads present value and setting value from temperature controller every second and saves present value at MB200 and setting value at MB210.		

[Table 11.4.1] User defined communication system configuration

Note1) Delay time is set to prevent from frame error when communication with device of which response is slow in case of RS-422/485 communication. It varies according to partner device and it has 50~100ms value generally.

### 11.4.2 User definition communication frame structure

Frame structure of PC Link, communication protocol of Han-Young used in this example, is as follows.

- Frame of temperature controller is executed as ASCII character string, it can read/write defined D, I Register. There are two protocols, STD standard protocol and SUM protocol adding Check Sum to standard type and protocol is selected by parameter of temperature controller. Standard protocol is STD". It starts with first character STX (0x02) and ends with last character CR(0x0D) LF(0x0A). The following [Table 10.4.2] and [Table 10.4.3] indicates structure of standard protocol and Sum protocol.

STX	Station no.	Command	Data	CR	LF
0x02	1~99			0x0D	0x0A

[Table 11.4.2] standard protocol structure

STX	Station no.	Command	Data	Error code	CR	LF
0x02	1~99			Check Sum	0x0D	0x0A

[Table 11.4.3] SUM protocol structure

(1) Writing example frame

In this example, present value and setting value is saved in M device area of PLC. [Table 11.4.4] is frame requesting continuous data and [Table 11.4.5] is frame responding to request.

Frame	STX	Station no.	DRS	,	No. of data	Start address of D register	CR	LF
(Byte)	1	2	3	1	2	4	1	1

[Table 11.4.4] request frame

- **DRS:** command that request reading continuous D register value. No of data and start address of D register is necessary.
- In the example, no. of data is 2 and start address is 01.

Frame	STX	Station no.	DRS	,	OK	,	Data 1	,	Data N	CR	LF
Size (Byte)	1	2	3	1	2	1	4	1	4	1	1

[Table 11.4.5] response frame

### 11.4.3 User definition communication parameter setting

(1) Communication standard parameter setting

For standard setting, refer to setting method when acting as P2P service of 10.1.2 and configure above system [Table 11.4.1].

(2) Writing frame that requests reading data

Describes how to write frame at XG5000 for user definition communication

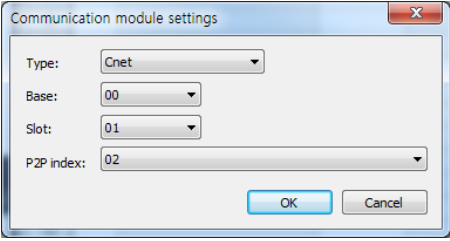
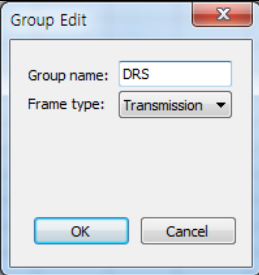
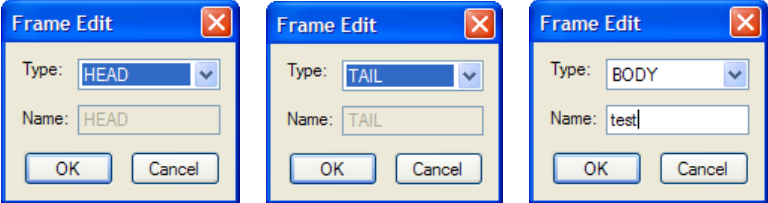
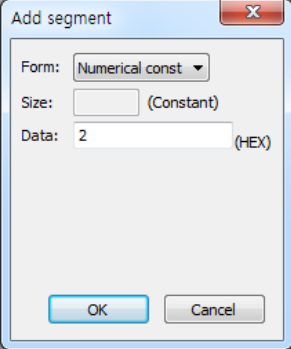
frame that requests reading data (Transmission frame)	
Sequence	Setting method
1	 <p>1. Right click PLC and select [Add Item] – [P2P Communication]                  2. As for built-in communication, base and slot is fixed as 0. Click OK.                  3. Double-click [P2P Channel] and select [User frame definition] in [Channel 2].</p>
2	 <p>1. Click user definition frame and click right button of mouse.                  2. Click 'Add Group' and input group name (DRS) and select frame type as transmission.</p>
3	 <p>1. Click 'Add Frame' and select type HEAD, TAIL, BODY and input BODY name                  2. BODY's name is test here.</p>
4	 <p>1. Double-click HEAD in the project tree, then segment setting window will be created                  2. Select Numerical constant which indicates Hex as ASCII code as Form. Input Hex value 2 which indicates STX.</p>

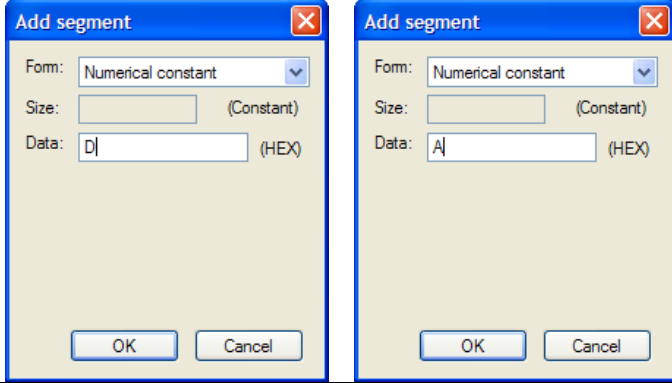
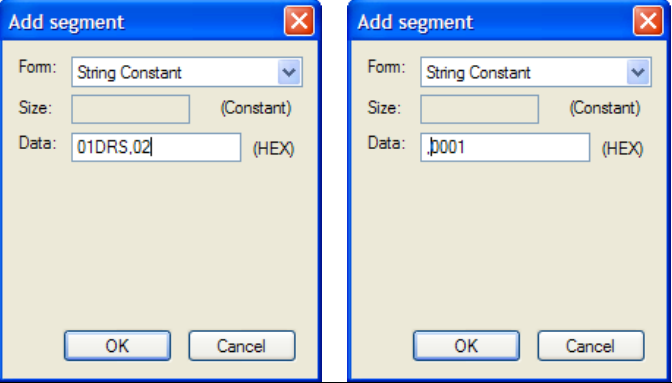
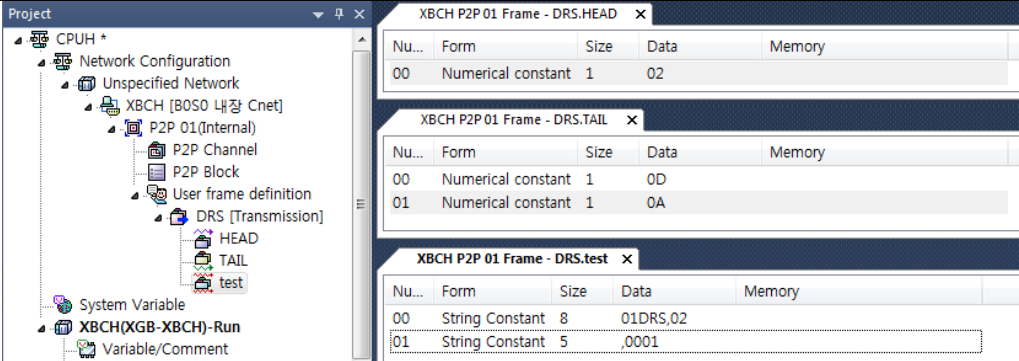
Sequence	Setting method
5	 <p data-bbox="395 689 1398 752">1. Select Numerical constant which indicates Hex as ASCII code as Form. Input Hex value D, A which indicates CR and LF.</p>
6	 <p data-bbox="395 1155 1449 1301">1. Double-click DRS.test tap and edit segment like the following. 2. Write frame requesting reading data of continuous 2 areas starting first of D register of station no.1. 3. When double-clicking editor screen and writing frame through segment edition, size of one segment is less than 10.</p>
7	 <p data-bbox="395 1671 1102 1704">1. Result writing entire frame of data reading request frame.</p>

(3) Writing frame to receive response frame of temperature controller

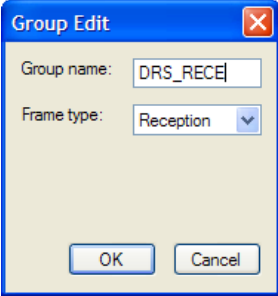
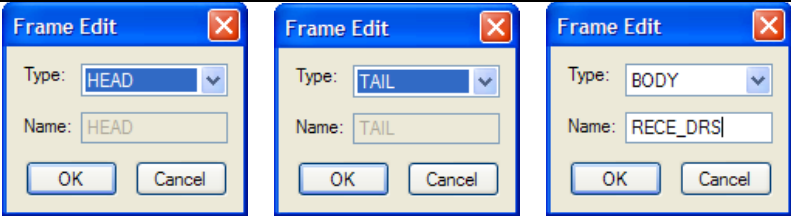
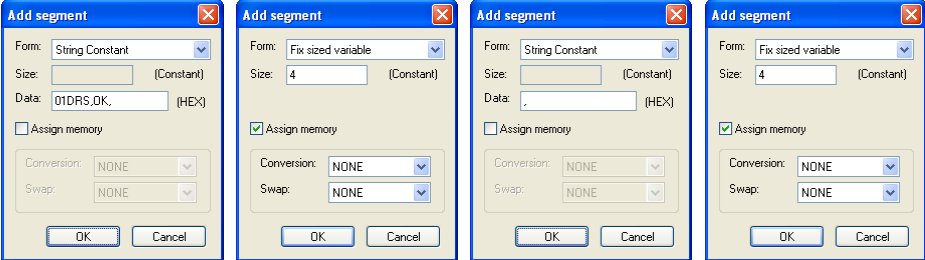
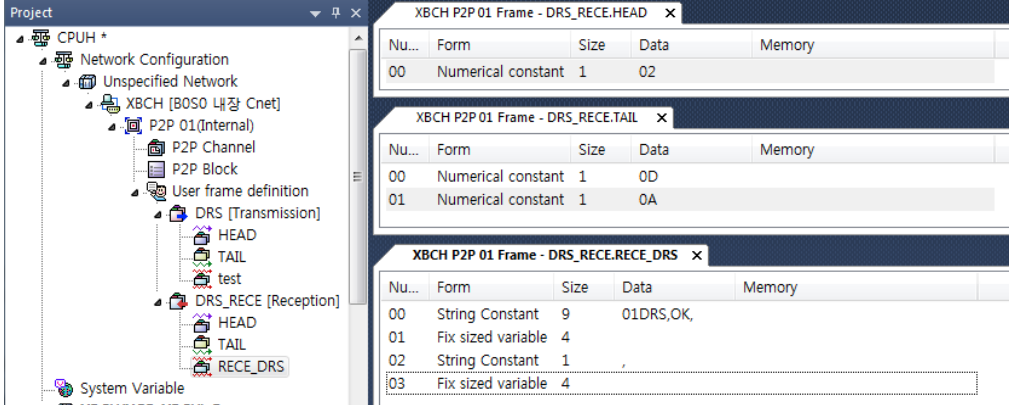
Writing response frame (Receive frame)	
Sequence	Setting method
1	 <p>1. Write like step 2 of frame that request reading data. At this time, set Frame type as receive. 2. Frame name is DRS_RECE.</p>
2	 <p>1. Click 'Add Frame' and select HEAD, TAIL, BODY as type and input BODY name. 2. BODY's name is RECE_DRS here.</p>
3	<p>1. Method writing HEAD, TAIL is same with step 4~5 of method writing frame that request reading data.</p>
4	 <p>1. To save present temperature value in MB200 and setting value in MB210, set the storage area of 1<sup>st</sup> and 2<sup>nd</sup> data as set in [Table 10.4.1]. 2. Since data size of data 1 and 2 is 4 byte, select Fix sized variable and input 4 in Size 3. To select storage area of data, check Assign memory.</p>
5	 <p>1. This is entire frame to receive response data of temperature controller.</p>

# Chapter 11 Example program

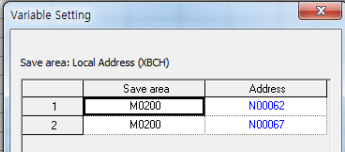

## (4) Writing P2P transmission/receive block

Write P2P TX/RX block as follows by using user definition communication segment written ahead.

Sequence	Setting method													
1	Index	Ch	Driver Setting	P2P function	Conditional flag	Command type	Data type	No. of variables	Data size	Destination station	Destination station number	Frame	Setting	Variable setting contents
	0	1	User frame definition	SEND	F00093							DRS.test	Setting	
	1	1	User frame definition	RECEIVE								DRS_RECE.RECE_DRS	Setting	Number:2 SAVE1:M0200 SAVE2:M0200
	2												Setting	
	3												Setting	
	4												Setting	
	5												Setting	
	6												Setting	
	7												Setting	
	8												Setting	
9												Setting		
														
<ol style="list-style-type: none"> <li>1. Double-click P2P block of P2P 01.</li> <li>2. Input channel selected at P2P channel (user frame definition).</li> <li>3. In case P2P function is TX frame, select SEND. In case P2P function is RX, select RECEIVE.</li> <li>4. Conditional flag is activated when P2P function is SEND.</li> <li>5. Since it reads data every 1 second, use F93 as conditional flag.</li> <li>6. Click Setting of RX frame and set save area of current temperature and setting value.</li> </ol>														
2	Execute Write Parameter and Enable Link.													

## (5) Checking TRX data

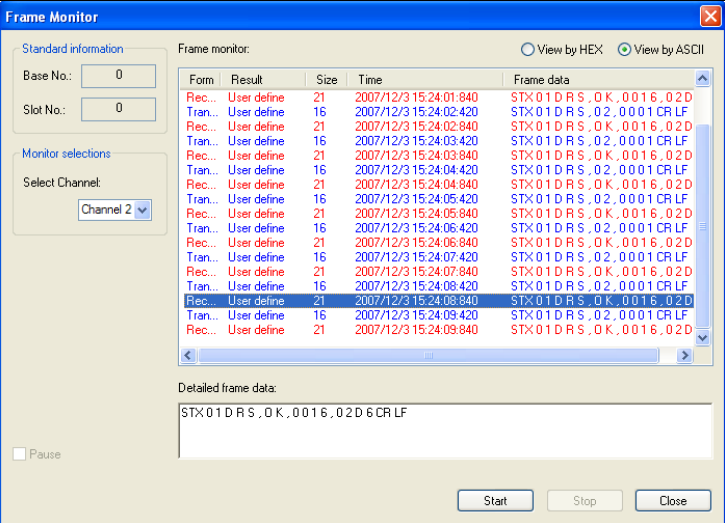
Check whether written frame is transmitted/received properly

Sequence	Setting method														
1															
	<ol style="list-style-type: none"> <li>1. Select [Online]-[Communication module setting]-[System Diagnosis] or click icon </li> <li>2. After clicking relevant module and click right button of mouse, select Status by service or frame monitor.</li> <li>3. When frame is not dealt with properly, unknown message is displayed.</li> </ol>														
	2	Check device area by device monitor of XG5000.													

## 11.5 SMS transmission method using the CDMA modem

This example is a method to send CDMA modem road SMS using the UDATA function of the Cnet I/F module.

This example made the CDMA modem in an exercise to send a message to using BSM-856R, RCU-890. [Figure 11.5.1] below shows the environment where Cnet module and a CDMA modem were constructed.

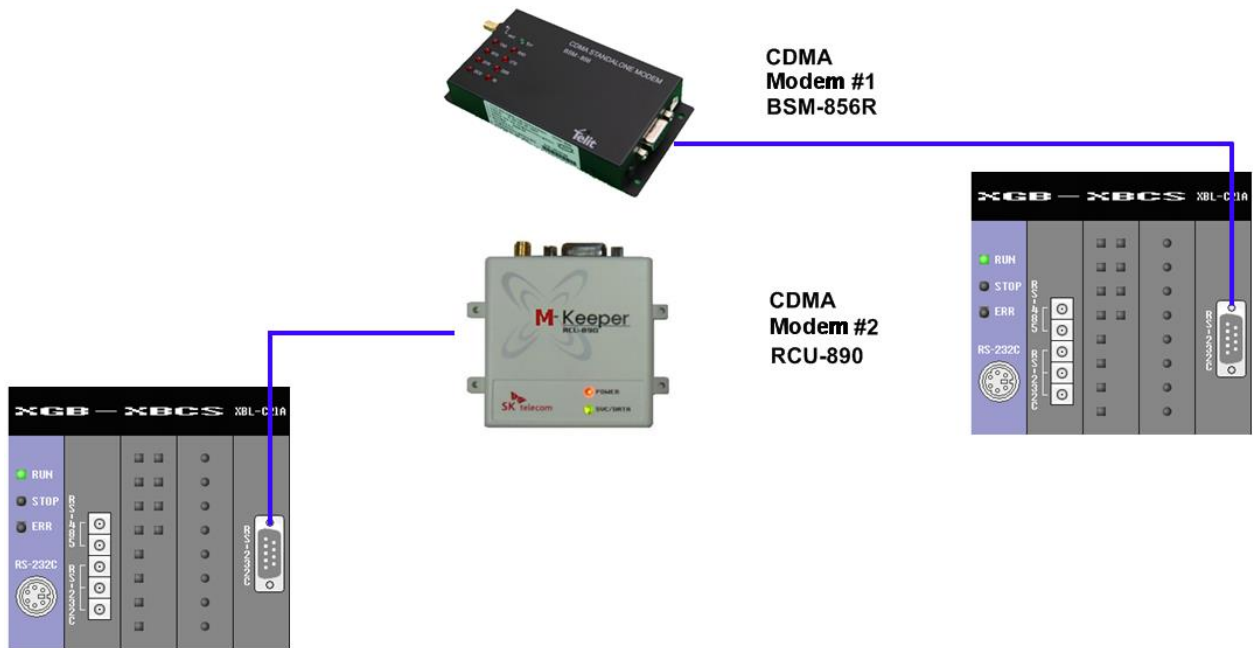

[Figure 11.5.1] Example of CDMA communication system

▶ Cnet I/F module

The Cnet I/F modem is used by a use to control a CDMA modem and uses CDMA modem and the RS-232 communication. CDMA modem send the AT instruction controlling a CDMA modem, to receive it, and to control a modem

▶ CDMA modem

CDMA modem performe the functions such as setting a modem in the AT instruction which modem received from Cnet I/F modem, making a call, SMS transmission and receive and the M2M modem connection.

Please refer to the user's manual which was provided by production Corporation th control a modem, because the AT instruction are different by modem distinction between production company.

When a modem uses DTR/RTS of RS-232, SEND\_DTR, SRND\_RTS can control a signal of DTR/RTS in the UDATA instruction for the normal communication.

▶ Parameter setting

	BSM-856R	RCU-890
Type	RS-232C	RS-232C
Speed	115,200	115,200
Data bit	8	8
Stop bit	1	1
Parity bit	NONE	NONE

Note1) BSM-856R and RCU-890's basic value is 115,200(Factory initialization setting)

The communication setting of the modem is possible according to the setting of the user. Please refer to the manual of the modem

► XBL-C21A setting

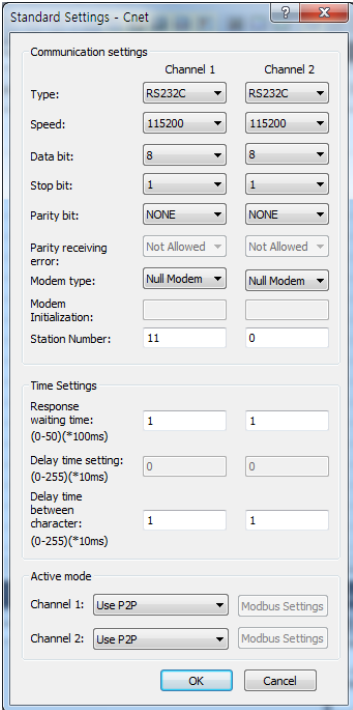
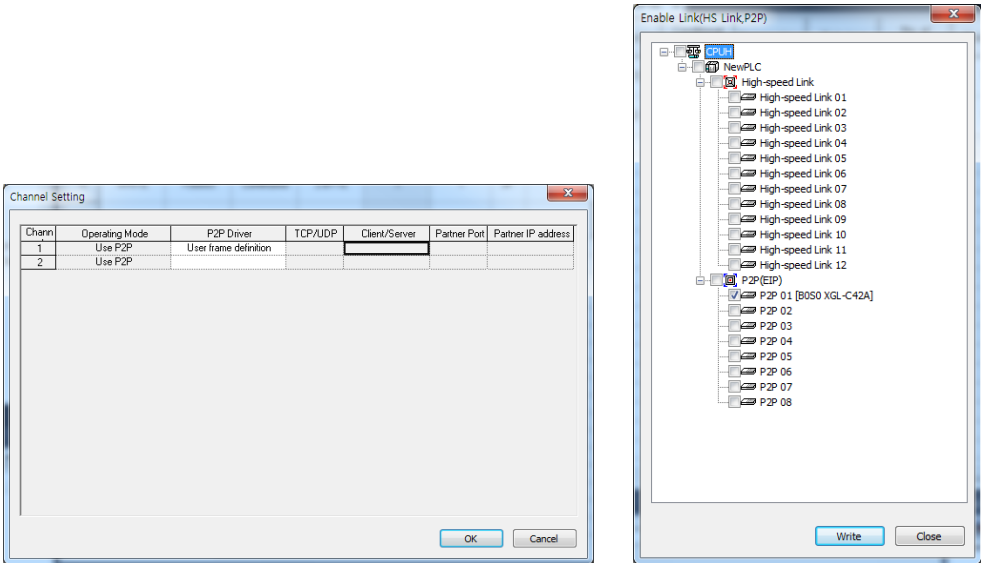
Sequence	Setting method
1	 <ol style="list-style-type: none"> <li>1. Set standard setting at the channel 1 to be same with setting described in the example of client above. Speed(115,200), Data bit(8), Stop bit(1), parity bit(NONE)</li> <li>2. When acting as client mode, active mode should be Use P2P settings.</li> </ol>
2	 <ol style="list-style-type: none"> <li>1. Double-click <b>P2P Channel</b> and select <b>User frame definition</b> in <b>Channel 1</b>.</li> <li>2. Click the P2P to enable and click Write.</li> </ol>



### 11.5.1 SMS send message using CDMA modem

The Cnet I/F module communicate with a CDMA modem using the UDATA communication instruction. The communication method speaks the AT instruction to offer with a CDMA modem. Please refer to the use manual of the CDMA modem for the AT instruction. This example is the methods to explain SMS message send and receive using [Figure 11.5.1]

► DTR/RTS setting

The some CDMA modem uses the modem signal for RS-232 communication. Therefore, to communicate with such a modem, you should set DTR/RTS. Please refer to the use manual of the CDMA modem for this and the details contents.

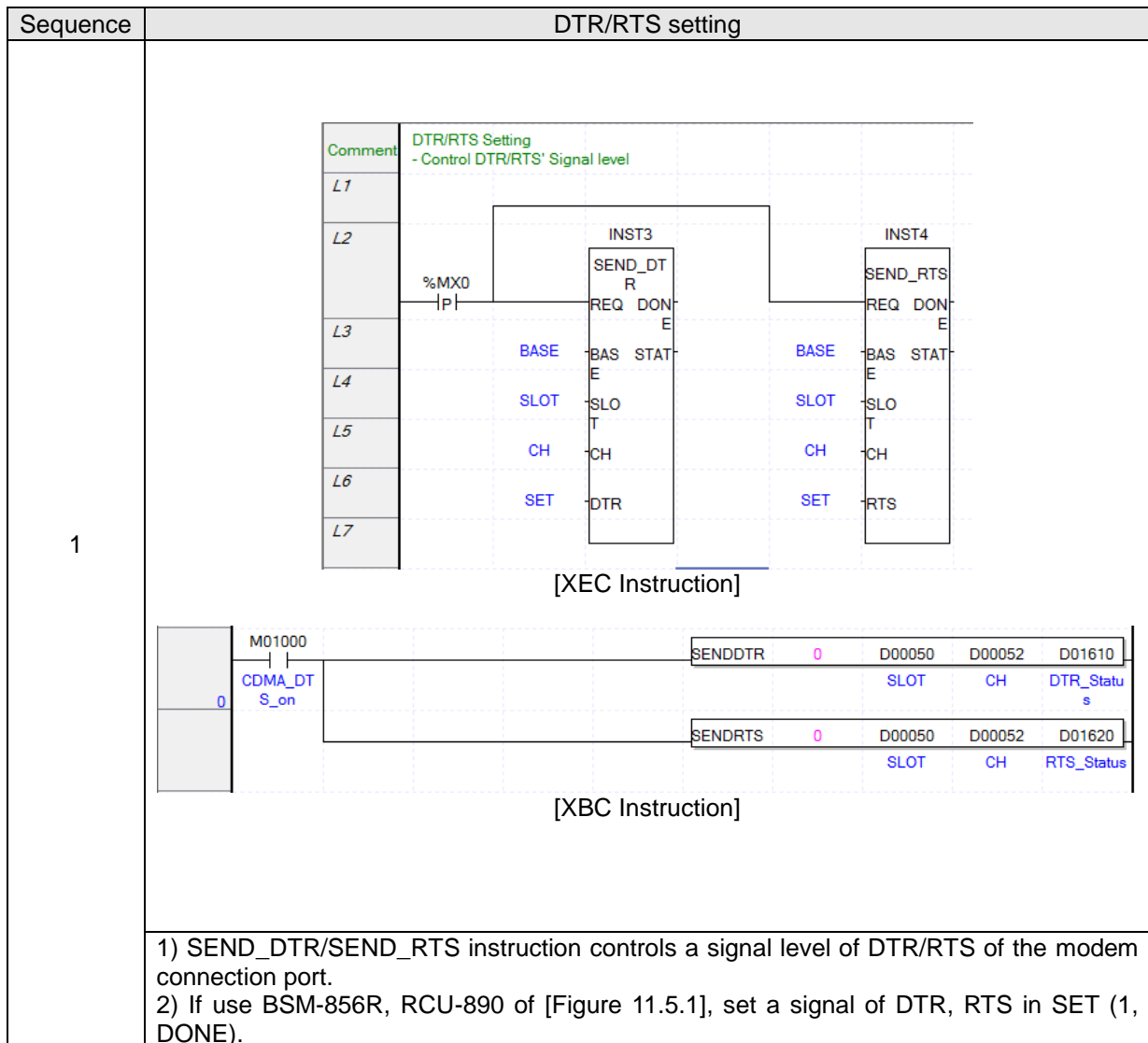

# Chapter 11 Example program

## ► SMS send message using XEC instruction

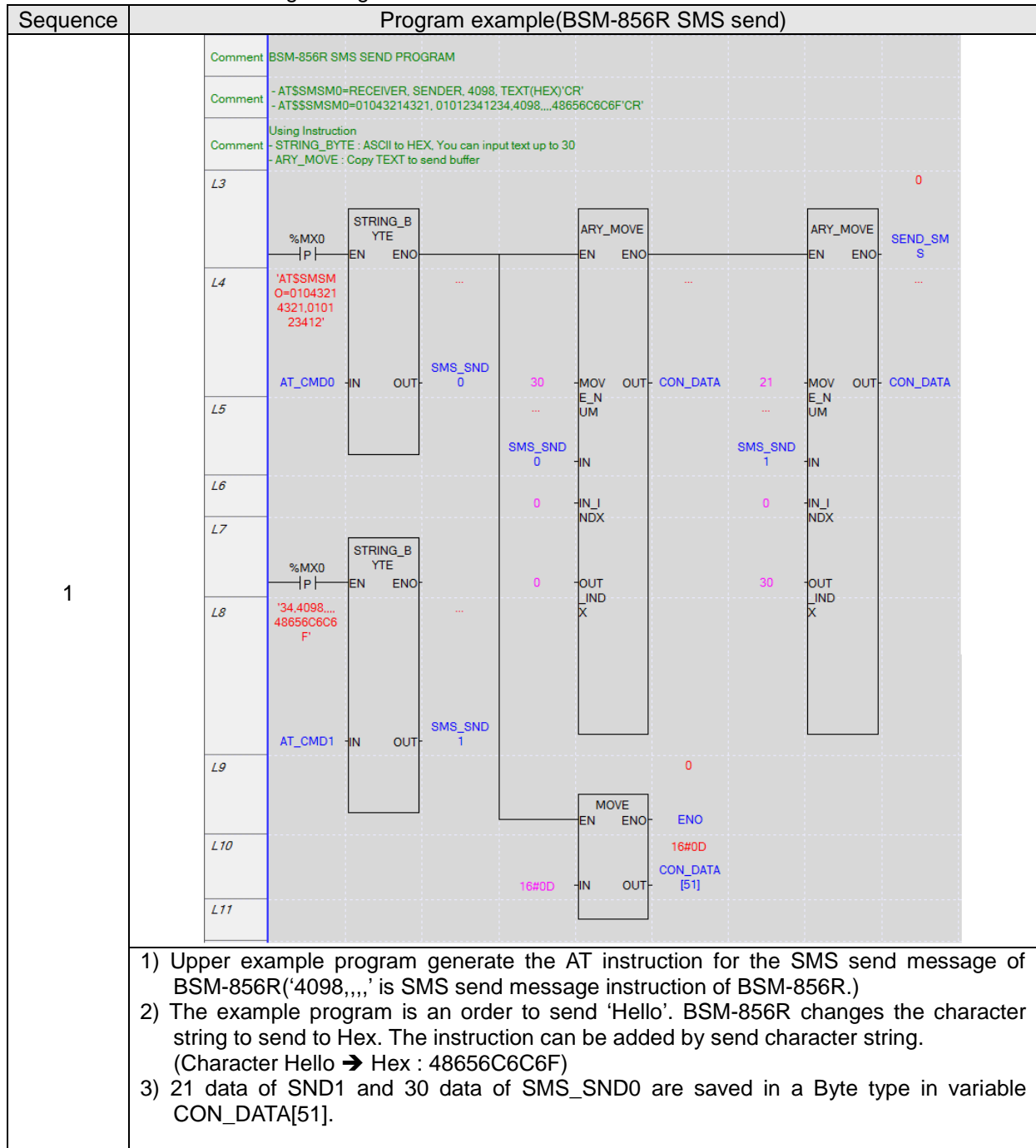

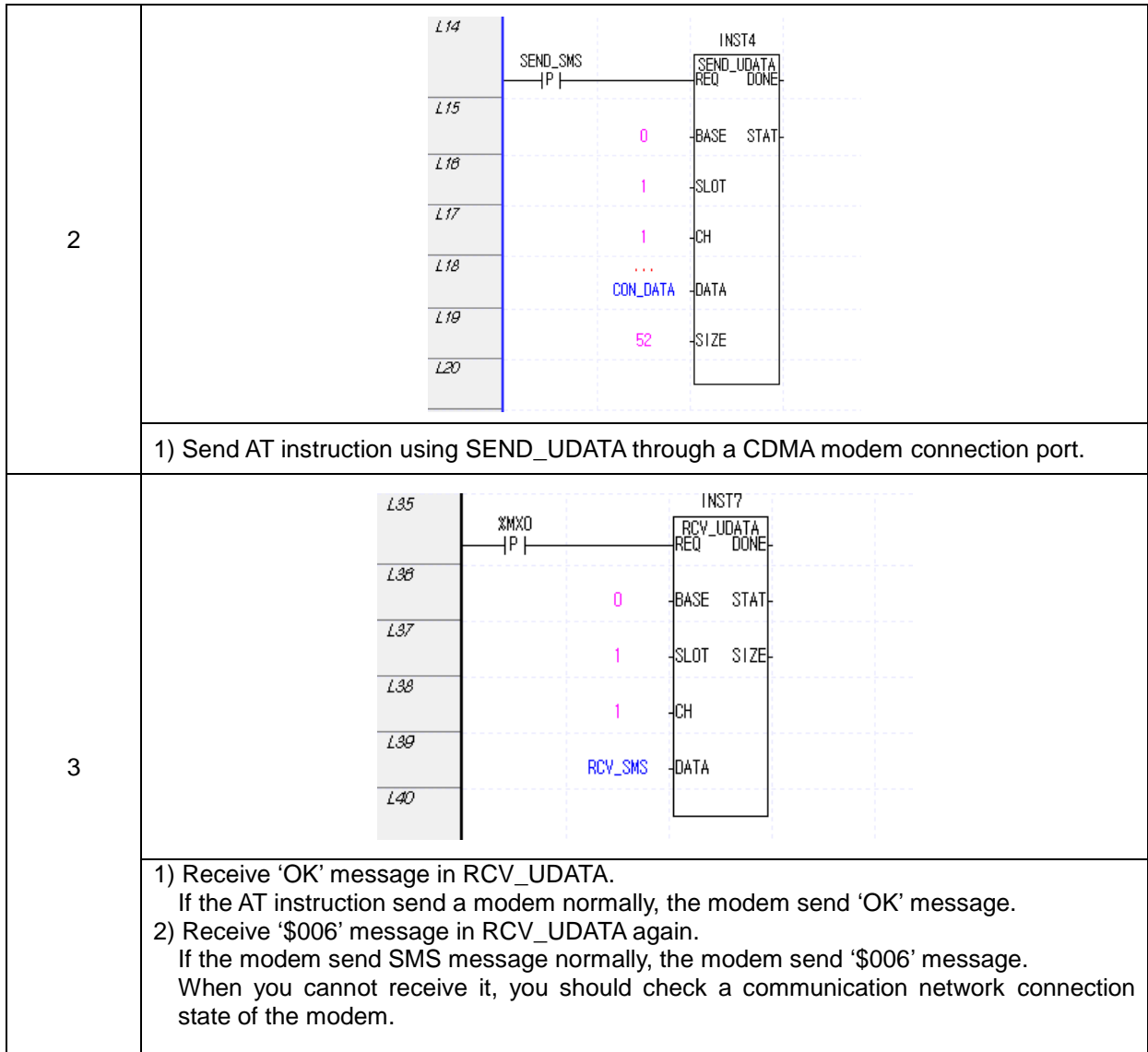

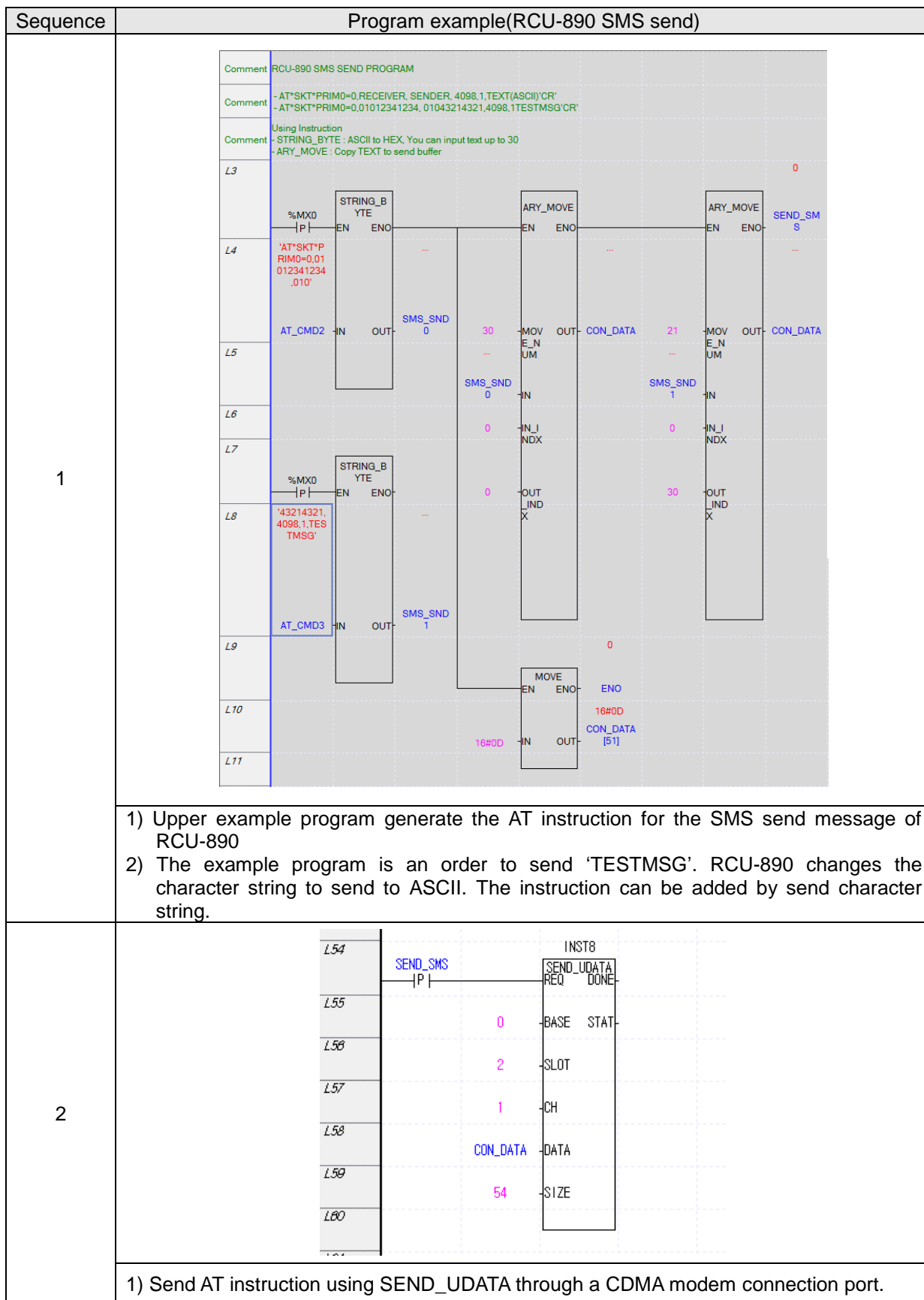



# Chapter 11 Example program

M02563

SNDUDATA	1	h0002	h5441	h0010	h0000
		D01130	D05500	D01131	D01132

타입	디바이스/변수	값
STRING	D05500	'ATDT01094714031'
WORD	D05507	h0031

프레임 모니터 창:  HEX로 보기  ASCII 로 보기

형태	처리 결과	크기	시간	프레임 데이터
송신	사용자 정의	16	0:01:51:080	A T D T 0 1 0 9 4 7 1 4 0 3 1 CR
수신	모름	16	0:01:51:200	A T D T 0 1 0 9 4 7 1 4 0 3 1 CR
수신	모름	11	0:01:58:810	CR LF C O N N E C T CR LF

1) Dialing: connect to 010-9471-4031  
 "ATDT01094714031" + 0x0D(ASCII code of CR): 16BYTE  
 2) Done if receive the CONNECT message

<Slot 1 send>

M02564

SNDUDATA	1	h0002	h3130	h000A	h0000
		D01140	D06000	D01141	D01142

타입	디바이스/변수	값
STRING	D06000	'0123456789'

프레임 모니터 창:  HEX로 보기  ASCII 로 보기

형태	처리 결과	크기	시간	프레임 데이터
송신	사용자 정의	10	0:00:03:530	0 1 2 3 4 5 6 7 8 9

<Slot 2 receive>

M02561

RCVUDATA	2	h0002	h3130	h000A	h0000
		D01110	D04500	D01111	D01112

타입	디바이스/변수	값
STRING	D04500	'0123456789'

프레임 모니터 창:  HEX로 보기  ASCII 로 보기

형태	처리 결과	크기	시간	프레임 데이터
수신	모름	10	0:00:12:350	0 1 2 3 4 5 6 7 8 9

1) Data send/receive: check if slot 1 sends "0123456789" 10BYTE then slot 2 receives

## Chapter 12 Installation and Wiring

### 12.1 Safety Instruction



#### Danger

- ▶ Please design protection circuit at the external of PLC for entire system to operate safely because an abnormal output or an malfunction may cause accident when any error of external power or malfunction of PLC module.
  - (1) It should be installed at the external side of PLC to emergency stop circuit, protection circuit, interlock circuit of opposition action such as forward /reverse operation and interlock circuit for protecting machine damage such as upper/lower limit of positioning.
  - (2) If PLC detects the following error, all operation stops and all output is off.
    - (Available to hold output according to parameter setting)
    - (a) When over current protection equipment or over voltage protection operates
    - (b) When self diagnosis function error such as WDT error in PLC CPU occurs
- ▶ In case of error about IO control part that is not detected by PLC CPU, all output is off.

Design Fail Safe circuit at the external of PLC for machine to operate safely. Refer to 12.2 Fail Safe circuit.

  - (1) Because of error of output device, Relay, TR, etc., output may not be normal. About output signal that may cause the heavy accident, design supervisory circuit to external.
- ▶ In case load current more than rating or over current by load short flows continuously, danger of heat, fire may occur so design safety circuit to external such as fuse.
- ▶ Design for external power supply to be done first after PLC power supply is done. If external power supply is done first, it may cause accident by misoutput, misoperation.
- ▶ In case communication error occurs, for operation status of each station, refer to each communication manual.
- ▶ In case of controlling the PLC while peripheral is connected to CPU module, configure the interlock circuit for system to operate safely. During operation, in case of executing program change, operation status change, familiarize the manual and check the safety status. Especially, in case of controlling long distance PLC, user may not response to error of PLC promptly because of communication error or etc. Limit how to take action in case of data communication error between PLC CPU and external device adding installing interlock circuit at the PLC program.



### Danger

- ▶ Don't close the control line or communication cable to main circuit or power line. Distance should be more than 10mm. It may cause malfunction by noise.
- ▶ In case of controlling lamp load, heater, solenoid valve, etc. in case of Off -> On, large current (10 times of normal current) may flows, so consider changing the module to module that has margin at rated current.
- ▶ Process output may not work properly according to difference of delay of PLC main power and external power for process (especially DC in case of PLC power On-Off and of start time.  
For example, in case of turning on PLC main power after supplying external power for process, DC output module may malfunction when PLC is on, so configure the circuit to turn on the PLC main power first  
Or in case of external power error or PLC error, it may cause the malfunction.
- ▶ Not to lead above error to entire system, part causing breakdown of machine or accident should be configured at the external of PLC



12.1.1 Fail safe circuit

(1) example of system design (In case of not using ERR contact point of power module)

In case of AC

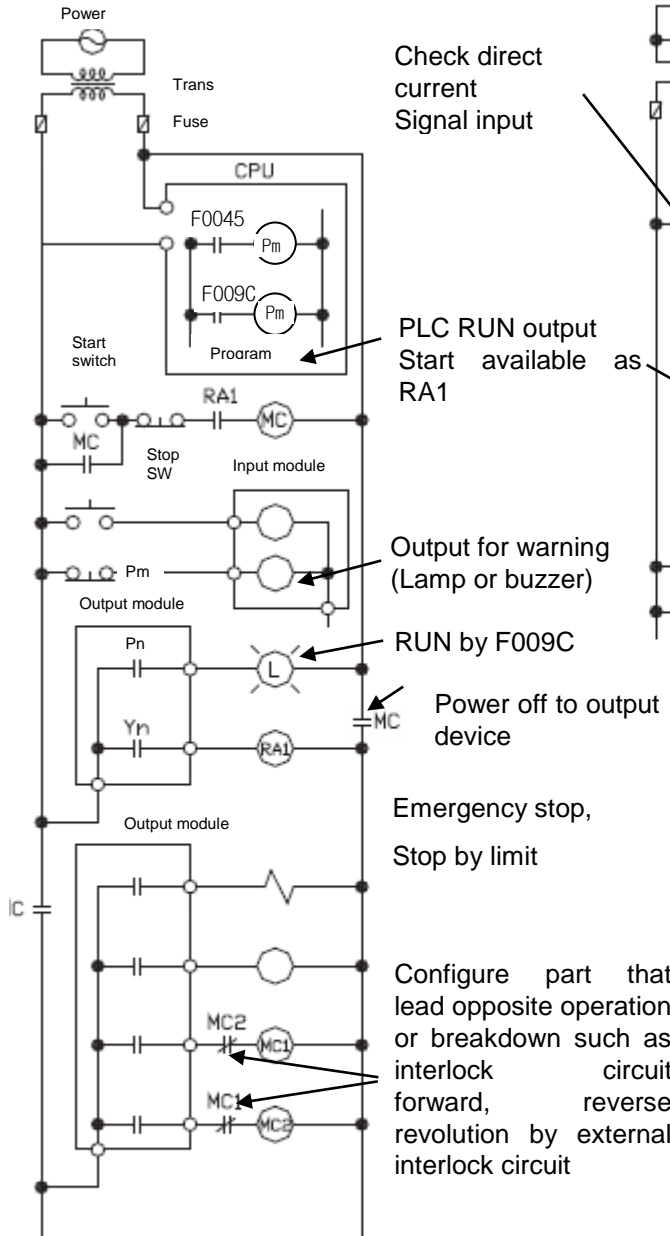

Start sequence of power  
In case of AC

- (1) Turn on power
- (2) Run CPU.
- (3) Turn on start switch
- (4) Output device runs by program through magnetic contactor (MC) [On]

In case of AC . DC

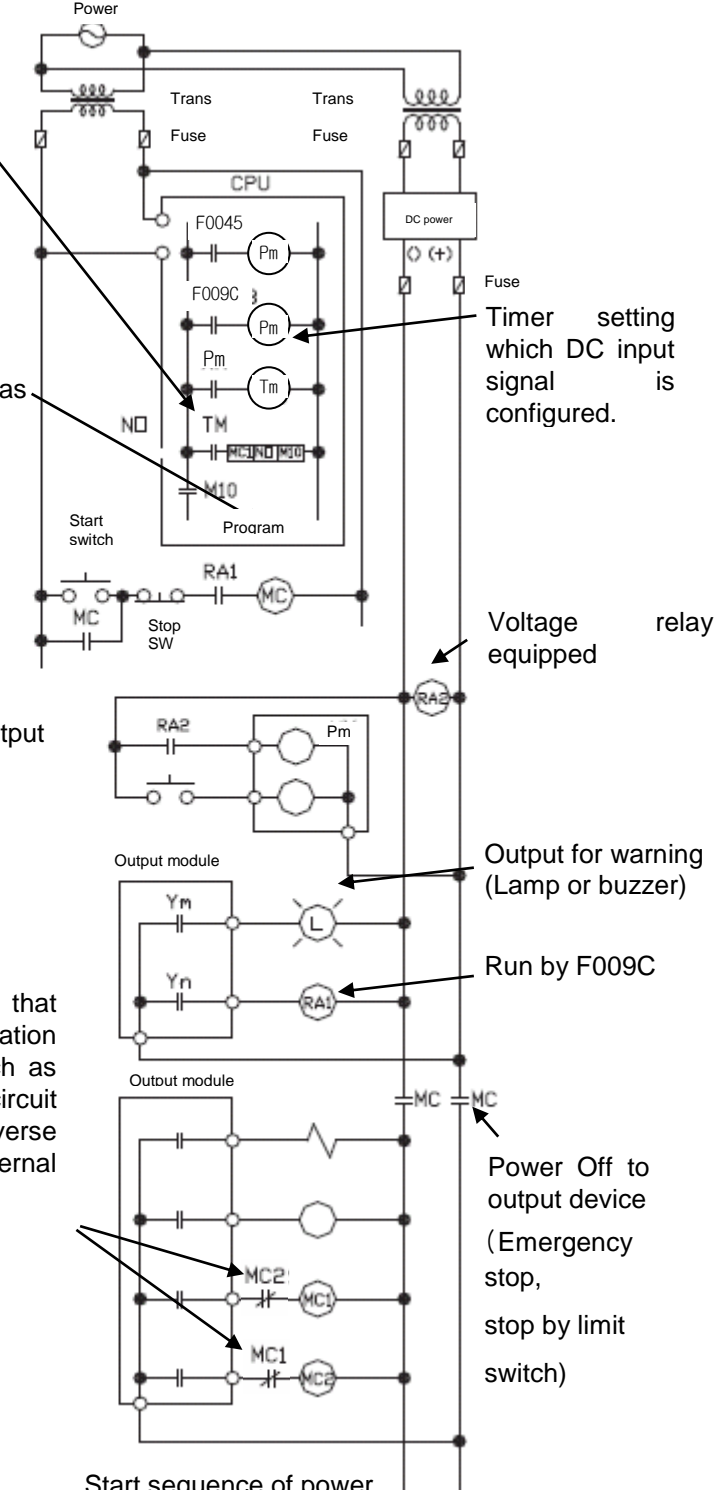

Start sequence of power  
In case of AC DC

- Run CPU after power is on
- (1) Turn on RA2 as DC power on
- (2) Turn on timer after DC power is stabilized.
- (3) Turn on timer after DC power is stable.
- (4) Turn on start switch
- (5) Output device runs by program through magnetic contactor (MC) [On]

(2) System design circuit example (In case of using ERR contact point of power module)

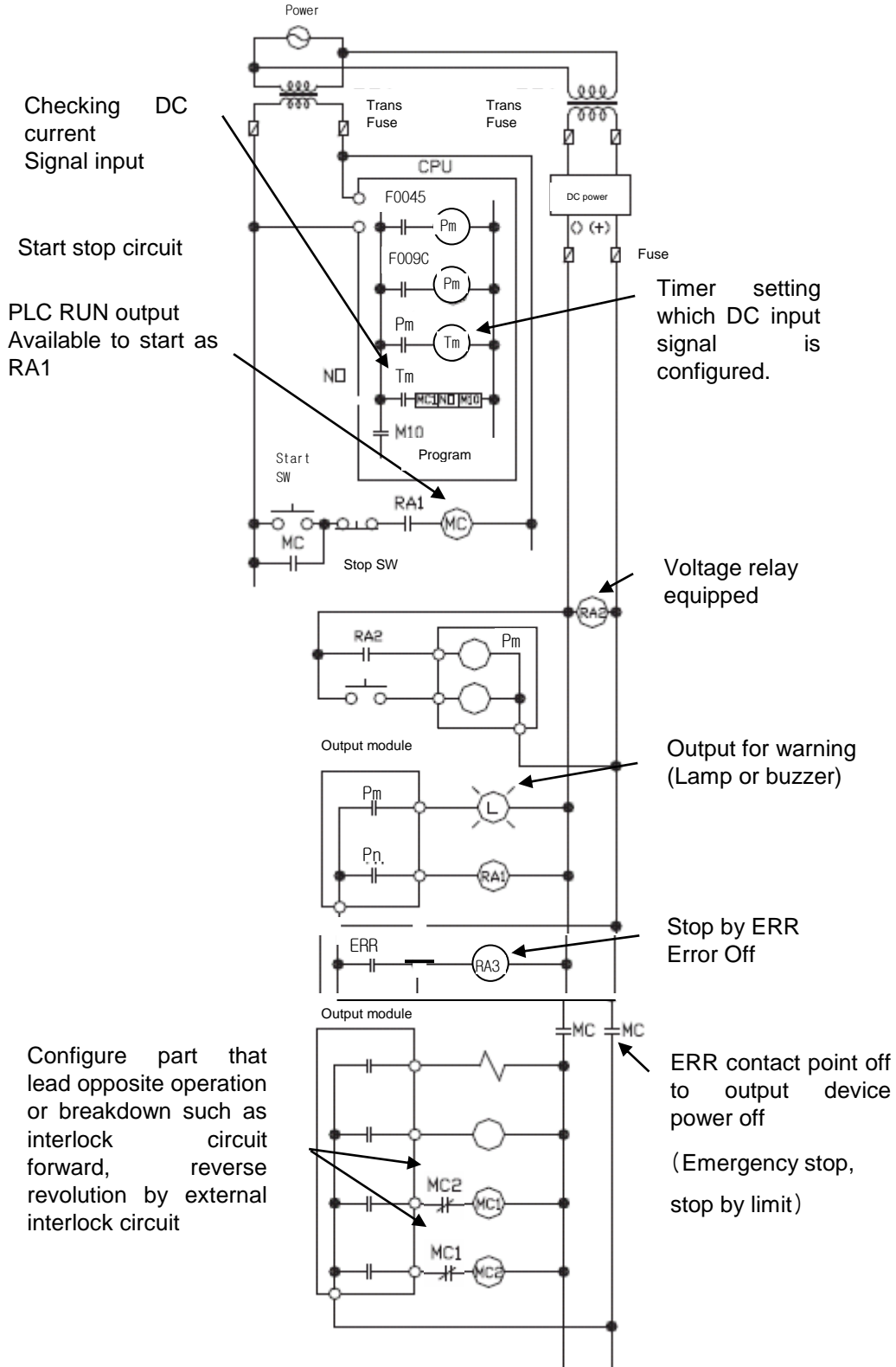

Start sequence of power  
In case of AC DC

- (1) Run CPU after turning on power.
- (2) Turn on RA2 with DC power supplied
- (3) Turn on timer after DC power is stable
- (4) Turn on start switch
- (5) Turn on start switch Output device runs by program through magnetic contactor (MC) [On]

### (3) Fail safe countermeasure in case of PLC error

Error of PLC CPU and memory is detected by self diagnosis but in case error occurs in IO control part, etc., CPU can detect the error. At this case, though it is different according to status of error, all contact point is on or off, so safety may not be guaranteed. Though we do our best to our quality as producer, configure safety circuit preparing that error occurs in PLC and it lead to breakdown or accident.

System example

Main unit	Input 16 point	Input 16 point	Input 16 point	Input 16 point	Output 16 point	Output 16 point
-----------	----------------	----------------	----------------	----------------	-----------------	-----------------

Output module for fail safe

Equip output module for fail safe to last slot of system.

[Fail safe circuit example]

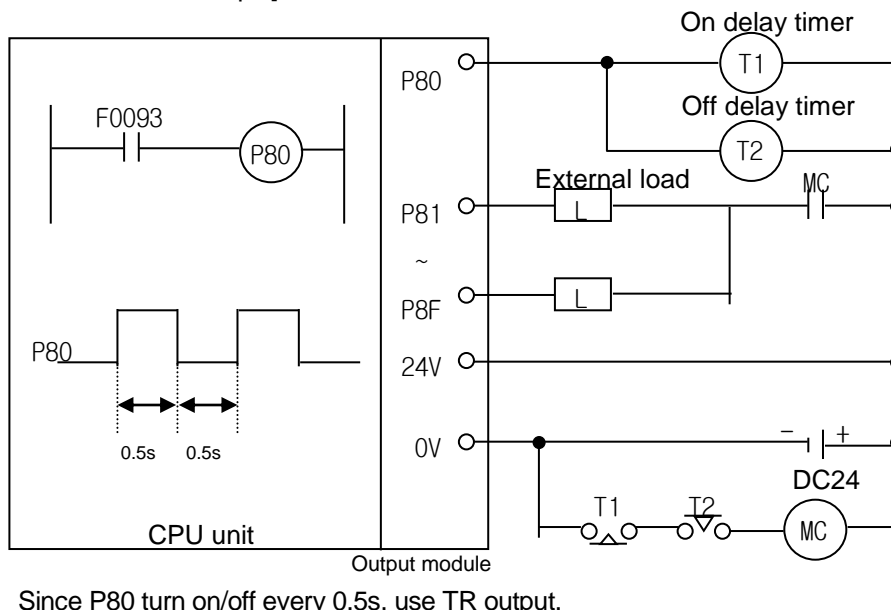

12.1.2 PLC heat calculation

(1) Power consumption of each part

(a) Power consumption of module

The power conversion efficiency of power module is about 70% and the other 30% is gone with heat; 3/7 of the output power is the pure power consumption. Therefore, the calculation is as follows.

- $W_{pw} = 3/7 \{ (I_{5V} \times 5) + (I_{24V} \times 24) \}$  (W)

$I_{5V}$  : power consumption of each module DC5V circuit(internal current consumption)

$I_{24V}$ : the average current consumption of DC24V used for output module  
(current consumption of simultaneous On point)

If DC24V is externally supplied or a power module without DC24V is used, it is not applicable.

(b) Sum of DC5V circuit current consumption

The DC5V output circuit power of the power module is the sum of power consumption used by each module.

- $W_{5V} = I_{5V} \times 5$  (W)

(c) DC24V average power consumption(power consumption of simultaneous On point)

The DC24V output circuit's average power of the power module is the sum of power consumption used by each module.

- $W_{24V} = I_{24V} \times 24$  (W)

(d) Average power consumption by output voltage drop of the output module(power consumption of simultaneous On point)

- $W_{out} = I_{out} \times V_{drop} \times \text{output point} \times \text{simultaneous On rate}$  (W)

$I_{out}$  : output current (actually used current) (A)

$V_{drop}$ : voltage drop of each output module (V)

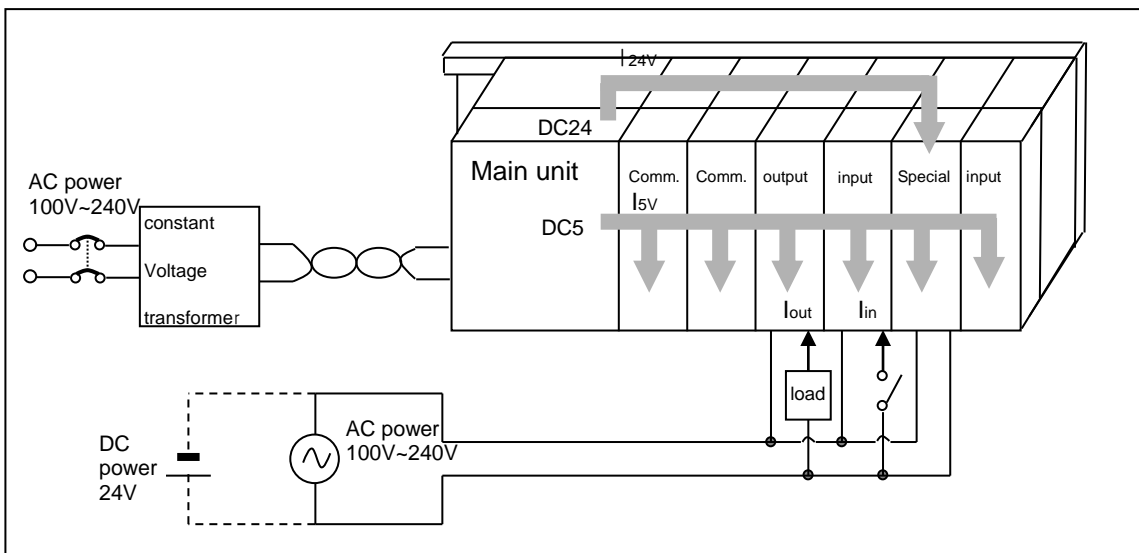

(e) Input average power consumption of input module  
(power consumption of simultaneous On point)

- $W_{in} = I_{in} \times E \times \text{input point} \times \text{simultaneous On rate (W)}$   
 $I_{in}$ : input current (root mean square value in case of AC) (A)  
 $E$ : input voltage (actually used voltage) (V)

(f) Power consumption of special module power assembly

- $W_s = I_{5V} \times 5 + I_{24V} \times 24 + I_{100V} \times 100 \text{ (W)}$

The sum of power consumption calculated by each block is the power consumption of the entire PLC system.

- $W = W_{PW} + W_{5V} + W_{24V} + W_{out} + W_{in} + W_s \text{ (W)}$

Calculate the heats according to the entire power consumption(W) and review the temperature increase within the control panel.

The calculation of temperature rise within the control panel is displayed as follows.

$$T = W / UA \text{ [}^\circ\text{C]}$$

$W$ : power consumption of the entire PLC system (the above calculated value)

$A$ : surface area of control panel [ $\text{m}^2$ ]

$U$ : if equalizing the temperature of the control panel by using a fan and others - - - 6

If the air inside the panel is not ventilated - - - - - 4

If installing the PLC in an air-tight control panel, it needs heat-protective(control) design considering the heat from the PLC as well as other devices. If ventilating by vent or fan, inflow of dust or gas may affect the performance of the PLC system.

## 12.2 Attachment/Detachment of Modules

### 12.2.1 Attachment/Detachment of modules

Caution in handling

Use PLC in the range of general specification specified by manual.

In case of using out of range, it may cause electric shock, fire, malfunction, damage of product.



### Warning

- ▶ Module must be mounted to hook for fixation properly before its fixation. The module may be damaged from over-applied force. If module is not mounted properly, it may cause malfunction.
- ▶ Do not drop or impact the module case, terminal block connector.
- ▶ Do not separate the PCB from case.

#### (1) Equipment of module

- Eliminate the extension cover at the upper of module.
- Push the module and connect it in agreement with hook for fixation of four edges and hook for connection at the bottom.
- After connection, get down the hook for fixation at the upper part and lower part and fix it completely.

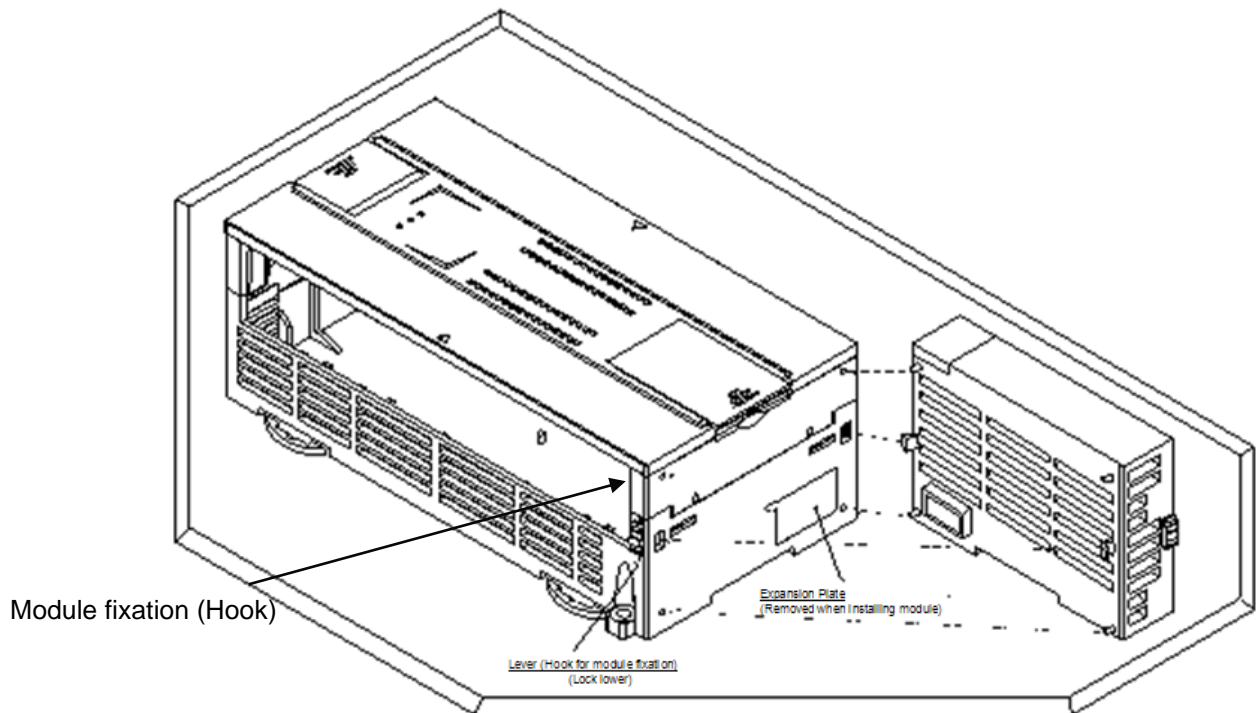

### (2) Detachment of module

- Get up the hook for fixation of upper part and lower part and disconnect it.
- Detach the module with two hands. (Don't force over-applied force.)

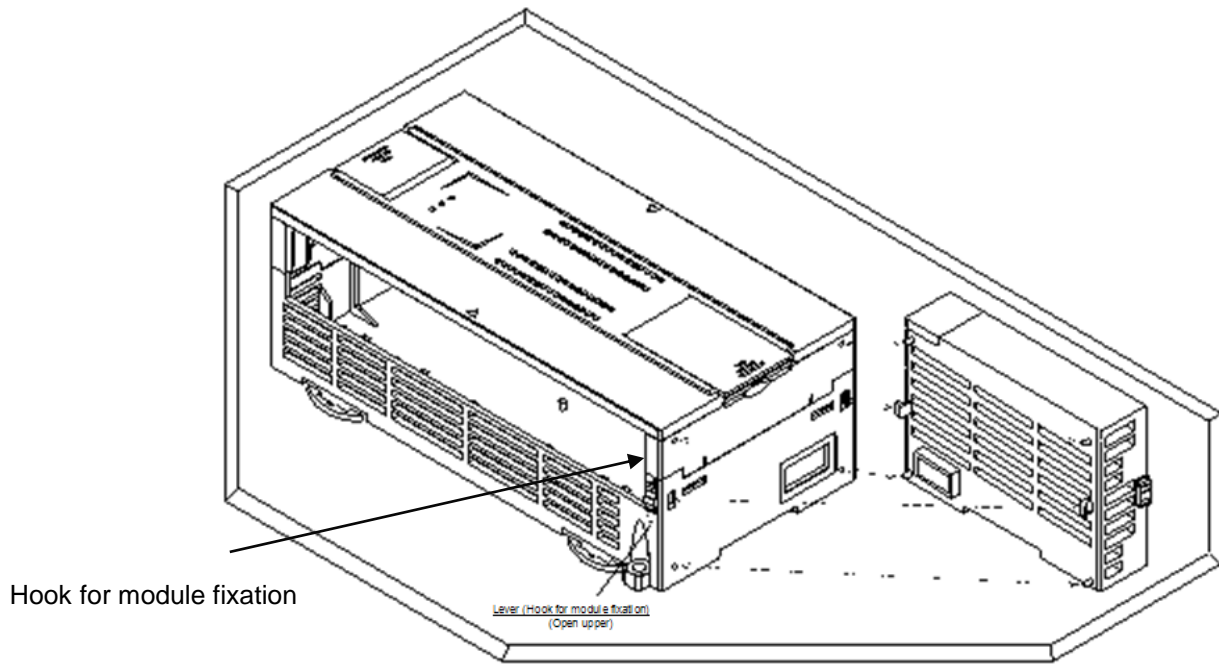

### Caution

- ▶ When separating module, don't force over-applied power. If so, hook may be damaged.

(3) Module equipment location

Keep the following distance between module and structure or part for well ventilation and easy detachment and attachment.

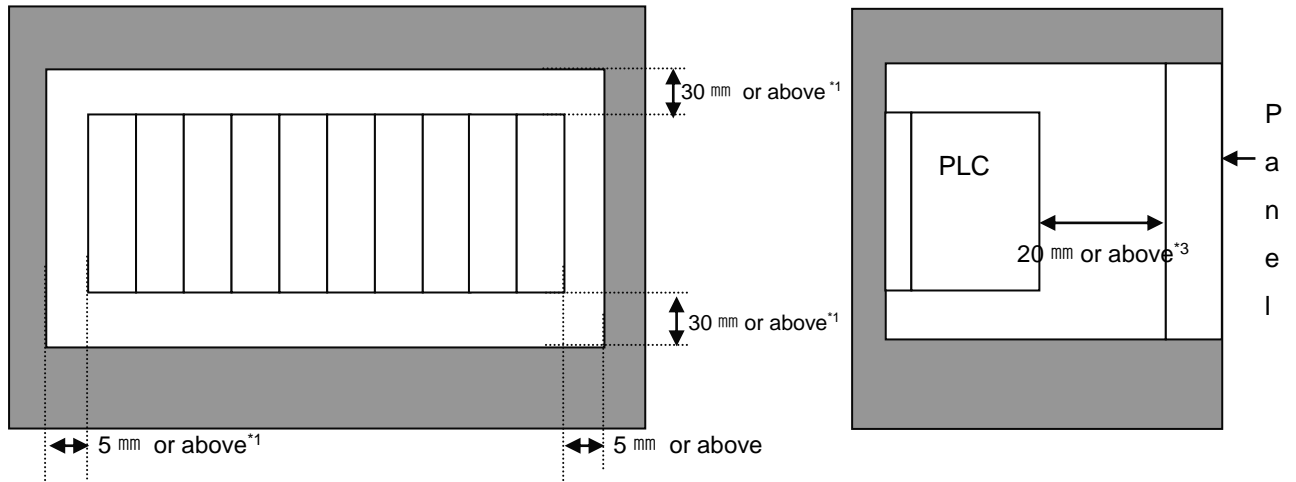

- \*1 : In case height of wiring duct is less than 50 mm (except this 40mm or above)
- \*2 : In case of equipping cable without removing near module, 20mm or above
- \*3 : In case of connector type, 80mm or above

(4) Module equipment direction

(a) For easy ventilation, install like the following figure.

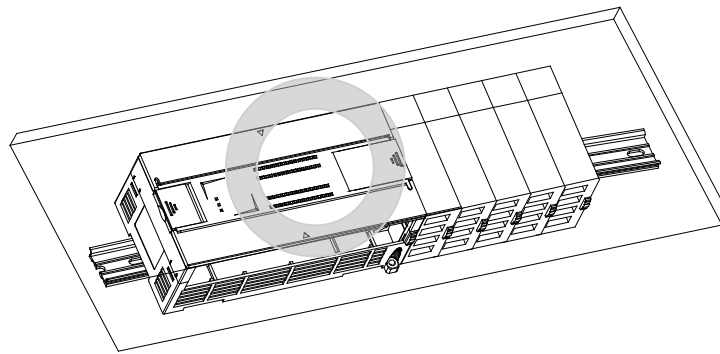



(b) Don't install like the following figure

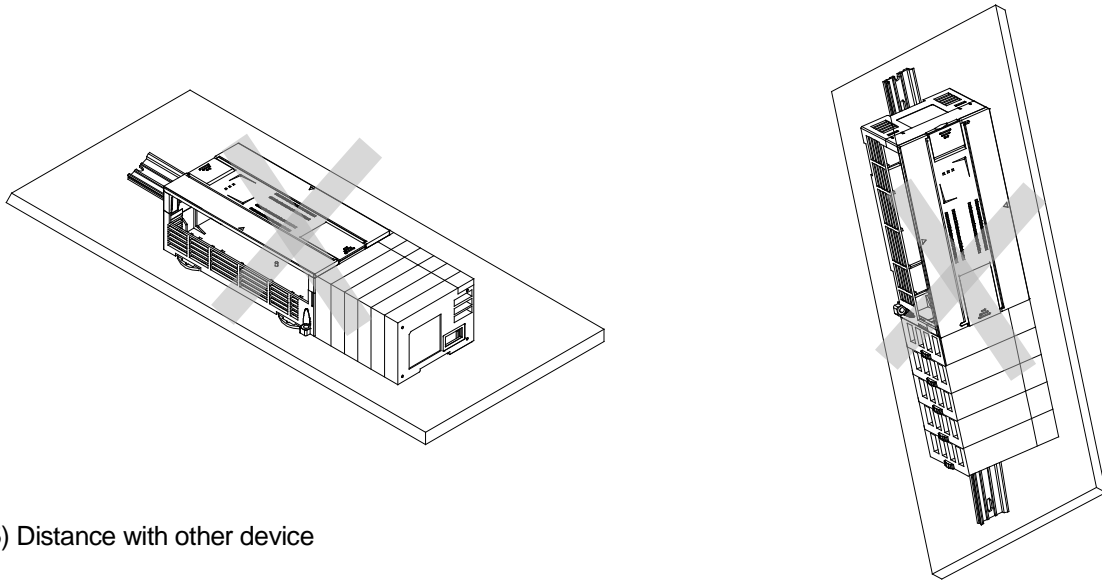

(5) Distance with other device

To avoid radiation noise or heat, keep the distance between PLC and device (connector and relay) as far as the following figure.

Device installed in front of PLC: 100 mm or above

Device installed beside PLC: 50 mm or above

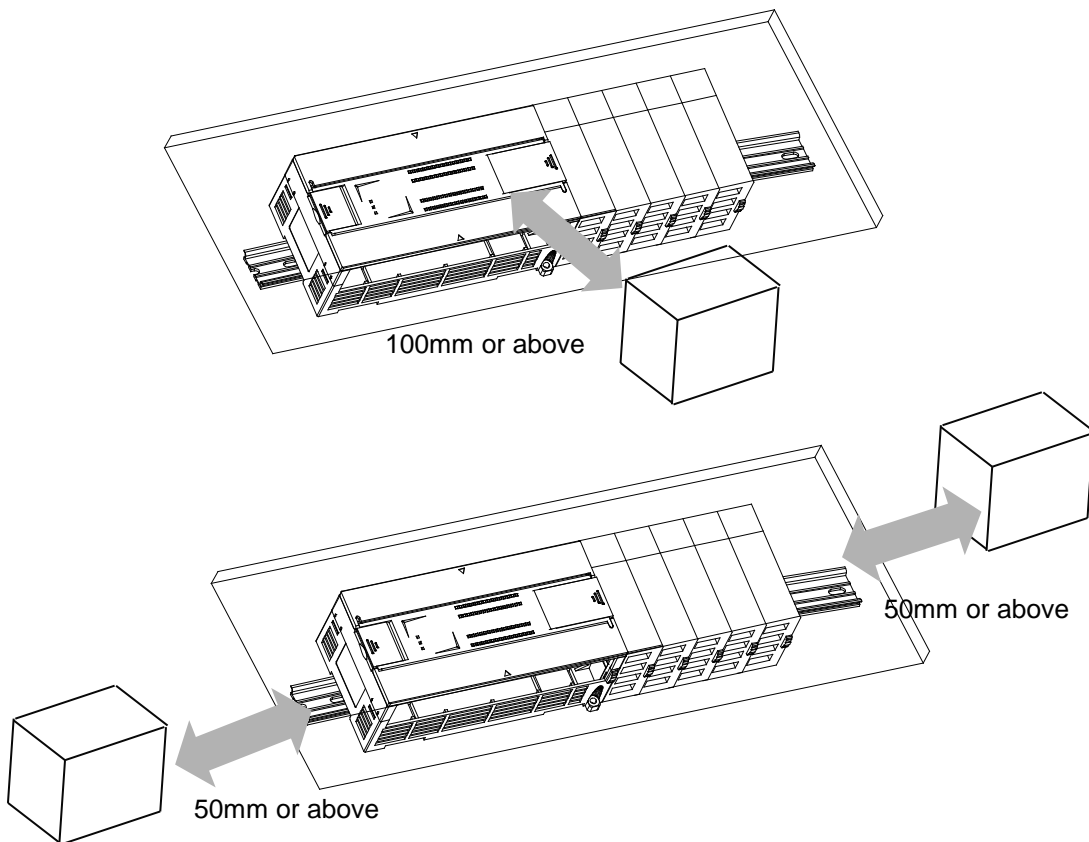

### 12.2.2 Caution in handling

Here describes caution from open to install

- Don't drop or impact product.
- Don't disassemble the PCB from case. It may cause the error.
- In case of wiring, make sure foreign substance not to enter upper part of module. If it enters, eliminate it.

#### (1) Caution in handling IO module

It describes caution in handling IO module

##### (a) Recheck of IO module specification

For input module, be cautious about input voltage, for output module, if voltage that exceeds the max. open/close voltage is induced, it may cause the malfunction, breakdown or fire.

##### (b) Used wire

When selecting wire, consider ambient temp, allowed current and minimum size of wire is AWG22(0.3mm<sup>2</sup>) or above.

##### (c) Environment

In case of wiring IO module, if device or material that induce high heat is too close or oil contacts wire too long time, it may cause short, malfunction or error.

##### (d) Polarity

Before supplying power of module which has terminal block, check the polarity.

##### (e) Wiring

- In case of wiring IO with high voltage line or power line, induced obstacle may cause error.
- Let no cable pass the IO operation indication part (LED).  
(You can't discriminate the IO indication.)
- In case induced load is connected with output module, connect the surge killer or diode load to load in parallel. Connect cathode of diode to + side of power.

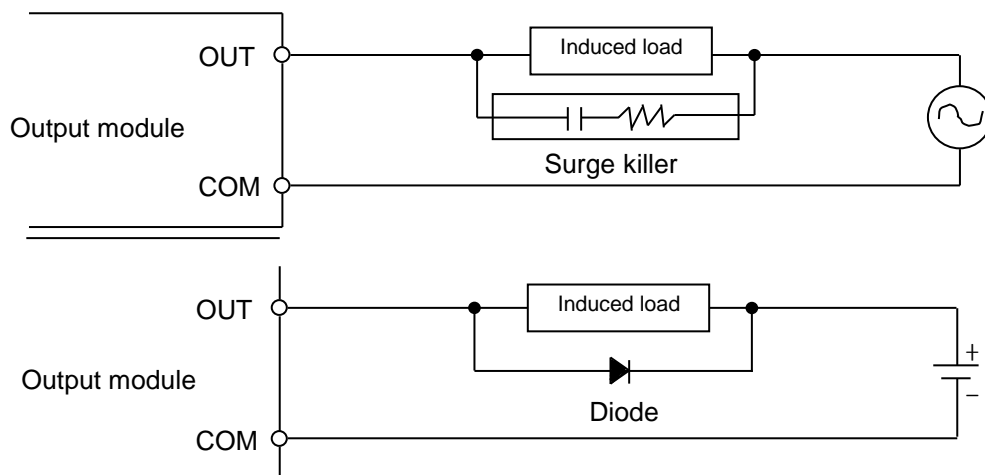

##### (f) Terminal block

Check close adhesion status. Let no foreign material of wire enter into PLC when wiring terminal block or processing screw hole. At this case, it may cause malfunction.

##### (g) Don't impact to IO module or don't disassemble the PCB from case.

## 12.3 Wire

In case using system, it describes caution about wiring.



### Danger

- ▶ When wiring, cut off the external power.
- ▶ If all power is cut, it may cause electric shock or damage of product.
- ▶ In case of flowing electric or testing after wiring, equip terminal cover included in product. If not, it may cause electric shock.



### Caution

- ▶ Do D type ground (type 3 ground) or above dedicated for PLC for FG and LG terminal. It may cause electric shock or malfunction.
- ▶ When wiring module, check the rated voltage and terminal array and do properly. If rating is different, it may cause fire, malfunction.
- ▶ For external connecting connector, use designated device and solder. If connecting is not safe, it may cause short, fire, malfunction.
- ▶ For screwing, use designated torque range. If it is not fit, it may cause short, fire, malfunction.
- ▶ Let no foreign material enter such as garbage or disconnection part into module. It may cause fire, malfunction, error.

### 12.3.1 Power wiring

- (1) In case voltage regulation is larger than specified, connect constant voltage transformer.

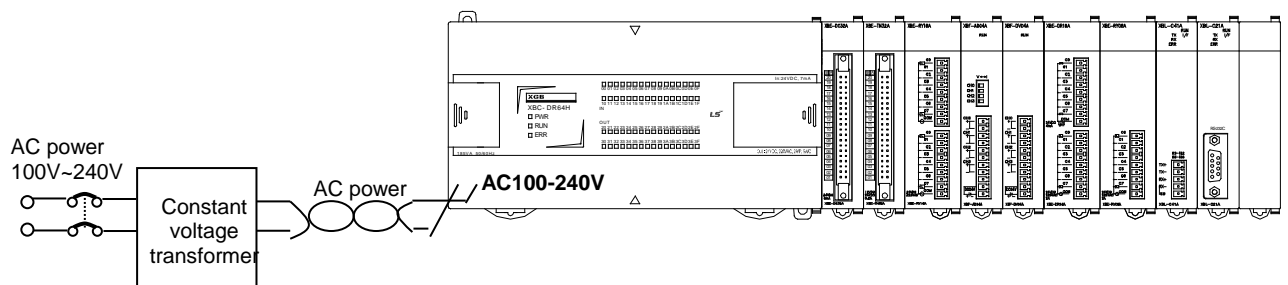

- (2) Connect power that include small noise between line and earth. (When there are many noise, connect insulated transformer.)

(3) Isolate the PLC power, I/O devices and power devices as follows.

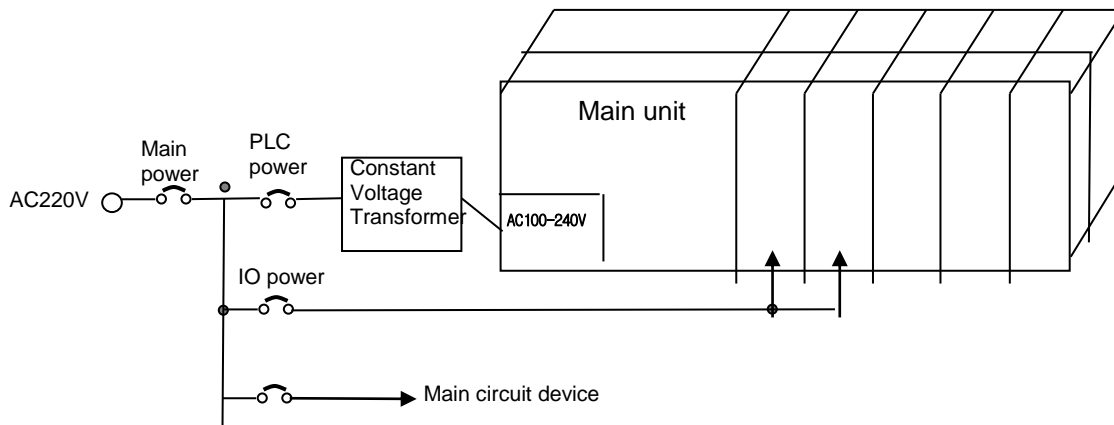

(4) If using DC24V of the power module

- (a) Do not connect DC24V of several power modules in parallel. It may cause the destruction of a module.
- (b) If a power module can not meet the DC24V output capacity, supply DC24V externally as presented below.

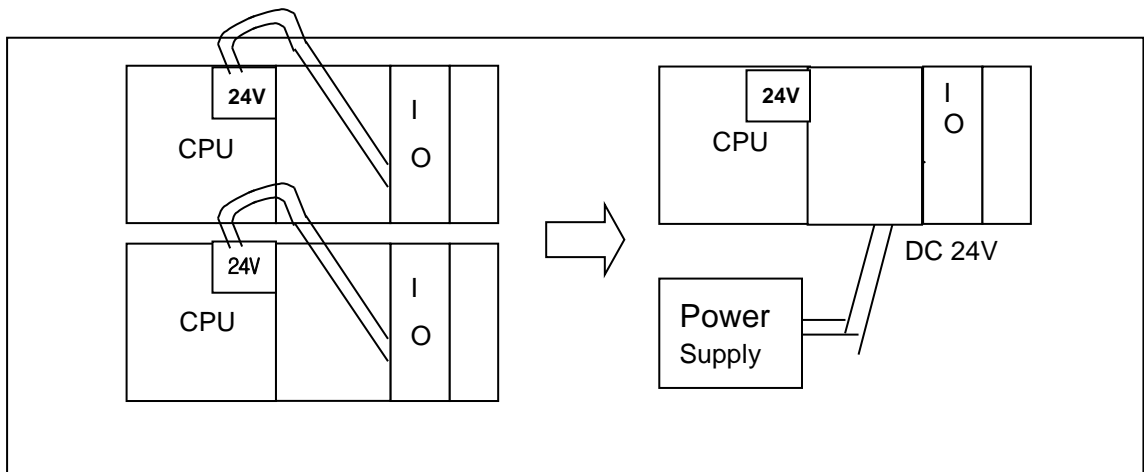

- (c) AC110V/AC220V/DC24V cables should be compactly twisted and connected in the shortest distance.
- (d) AC110V/AC220V cable should be as thick as possible(2mm<sup>2</sup>) to reduce voltage drop.
- (e) AC110V/ DC24V cables should not be installed close to main circuit cable(high voltage/high current) and I/O signal cable.
- (f) They should be 100mm away from such cables.

(5) To prevent surge from lightning, use the lightning surge absorber as presented below.

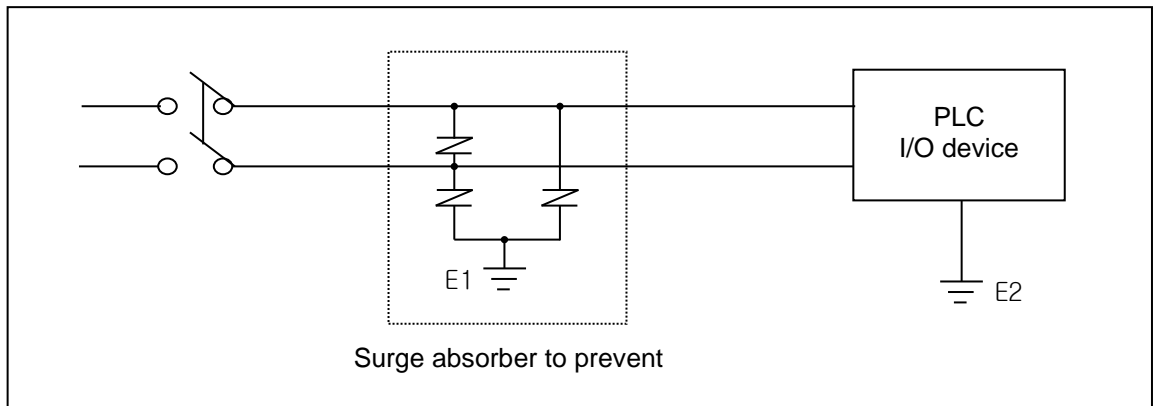

(6) When noise may be intruded inside it, use an insulated shielding transformer or noise filter.

(7) Wiring of each input power should be twisted as short as possible and the wiring of shielding transformer or noise filter should not be arranged via a duct.

### Note

- (1) Isolate the grounding(E1) of lightning surge absorber from the grounding(E2) of the PLC.
- (2) Select a lightning surge absorber type so that the max. voltage may not the specified allowable voltage of the absorber.

### 12.3.2 I/O Device wiring

- (1) The size of I/O device cable is limited to 0.3~2 mm<sup>2</sup> but it is recommended to select a size(0.3 mm<sup>2</sup>) to use conveniently.
- (2) Please isolate input signal line from output signal line.
- (3) I/O signal lines should be wired 100mm and more away from high voltage/high current main circuit cable.
- (4) Batch shield cable should be used and the PLC side should be grounded unless the main circuit cable and power cable can not be isolated.

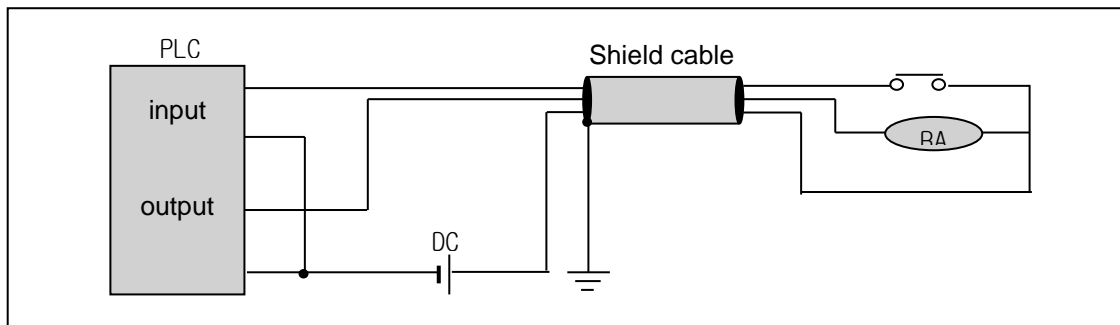

- (5) When applying pipe-wiring, make sure to firmly ground the piping.

## 12.4 Channel Operation during Normal Run

In case of built-in Cnet, each communication port operates independently to allow simultaneous Tx/Rx in separate transmission specifications. In case of XBL-C21A/C41A, only one channel is available. In case of built-in Cnet, transmission specifications can be set per RS-232C and RS-422 channel, and the operation is started and stopped according to channels. Data flow of each channel is as below.

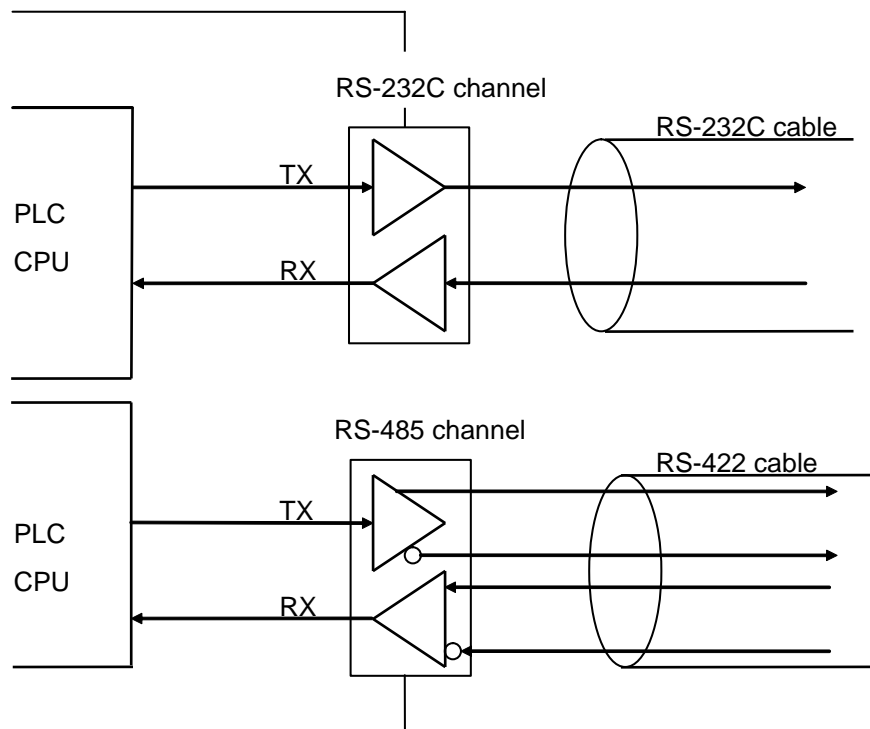

[Figure 12.4.1] Data Flow of Each Channel

**Notes**

[Note1] For mode change during RUN, download parameter by using XG5000. Though you don't reset the PLC, if download is complete, changed mode is applied.

## 12.5 Communication Interface Connection Method

### 12.5.1 RS-232C Interface (XBL-C21A)

Channel RS-232C uses 9-pin connector (Female) for communication with external devices. The names and functions of pins and data directions are as shown in the figure below.

Pin No.	Name	Contents	Signal Direction (Cnet I/F module ↔ external device)	Description
1	CD	Carrier Detect	←	Reports carrier detection of DCE to DTE
2	RxD	Received Data	←	Received data signal
3	TxD	Transmitted Data	→	Transmitted data signal
4	DTR	Data Terminal Ready	→	Reports ready communication of DTE <sup>Note1</sup> to DCE <sup>Note2</sup>
5	SG	Signal Ground	↔	Ground line for signal
6	DSR	Data Set Ready	←	Reports ready communication of DCE to DTE
7	RTS	Request To Send	←	DTE asks DCE to send data
8	CTS	Clear To Send	→	DCE asks DTE to send data
9	RI	Ring	←	Reports ringing tone received from DCE to DTE

[Figure 12.5.1] RS-232C 9-pin Connector Standard

Channel RS-232C can communicate with external devices directly and also with remote communication devices using modem. When connecting modem, communication type of RS-232C must be set to 'modem' with XG5000, and when not using modem, it must be set to null modem

#### Notes

[Note1] DTE: Data Terminal Equipment (Cnet I/F module)

[Note2] DCE: Data Communication Equipment (external modem)



## (1) How to connect RS-232C connector during modem connection (XBL-C21A)

This module can communicate with devices of long distance as connected with modem. Modem and RS-232C channel shall be connected as in [Figure 12.5.2] below.

Cnet (9-PIN)		Connection No. and signal direction	Modem side (25-PIN)	
Pin No.	Name		Name	Pin No.
1	CD	←	CD	8
2	RXD	←	RXD	3
3	TXD	→	TXD	2
4	DTR	→	DTR	20
5	SG		SG	7
6	DSR	←	DSR	6
7	RTS	→	RTS	4
8	CTS	←	CTS	5
9	RI <sup>[Note]</sup>		RI	22

[Figure 12.5.2] Cable Connection between RS-232C and Modem

[Note] No.9, RI signal is not used in XBL-C21A I/F module.

## (2) How to connect connector for RS-232C in null modem mode

In null modem mode, the connector can be connected in 3-line type as below.

Cnet (9-PIN)		Connection No. and signal direction	Computer/communication devices
Pin No.	Name		Name
1	CD		CD
2	RXD	←	RXD
3	TXD	→	TXD
4	DTR		DTR
5	SG		SG
6	DSR		DSR
7	RTS		RTS
8	CTS		CTS
9	RI		RI

[Figure 12.5.3] 3-line Type of Connection (no handshake)

### 12.5.2 RS-422/485 interface (Built-in communication)

Built-in communication channel (RS-232C/RS-485) uses 5-pin connector (Terminal Block) for communication with external devices. The names and functions of pins and data directions are as shown in [Figure 12.5.4] below

Pin no.	Name	Content	Signal direction (Cnet I/F module ↔ external device)	Function description
1	485-	485 – signal	←→	Built-in RS-485- signal
2	485+	485 + signal	←→	Built-in RS-485+ signal
3	SG	Signal Ground	—	Signal ground
4	TX	Transmitted Data	→	Built-in RS-232C TX data signal
5	RX	Received Data	←	Built-in RS-232C RX data signal

[Figure 12.5.4] RS-422 5-pin Connector Standard

Built-in RS-232C channel doesn't support modem communication. In case of modem communication, use XBC-C21A.

1) Connection method in case of using built-in RS-232C

In case of connecting as null modem mode, connect in 3 line type.

Cnet (9-PIN)		Connection no. and signal direction	PC/Communication device
Pin no.	Name		Name
3	SG	—	SG
4	TX	←→	TXD
5	RX	←→	RXD

[Figure 12.5.5] 3 line type connection

2) Connection method in case of using built-in RS-485

Pin no.	Name	Signal direction (Cnet<--->external device)	External communication device
1	485-	←→	485-
2	485+	←→	485-

[Figure 12.5.6] built-in RS-485 connection

**12.5.3 RS-422 interface (XBL-C41A)**

RS-422 channel use 5 pin connector (Terminal Block) for communicate with external [Figure 12.5.7] indicates function of each pin name, function and data direction.

Pin no.	Name	Signal direction (Cnet<-->External device)	Function description
1	TX+		TX data (+)
2	TX-		TX data (-)
3	RX+		RX data (+)
4	RX-		RX data (-)
5	S.G(SG)		Signal ground

[Figure 12.5.7] RS-422 5 pin connector pin standard

[Figure 12.5.8] indicates RS-422 communication cable connection example in case of single connection.

Cnet (5-Pin)		Signal direction (Cnet<--->External device)	External communication device
Pin no.	Name		
1	TX+		RX+
2	TX-		RX-
3	RX+		TX+
4	RX-		TX-
5	S.G(SG)		S.G

[Figure 12.5.8] RS-422 connection

[Figure 12.5.9] indicates RS-485 communication cable connection example in case of single connection

Cnet (5-Pin)		Signal direction (Cnet<--->External device)	External communication device
Pin no.	Name		
1	TX+		RX+
2	TX-		RX-
3	RX+		TX+
4	RX-		TX-
5	S.G(SG)		S.G

[Figure 12.5.9] RS-485 connection

Single and multi-drop connection with external device are available in XBL-C41A. [Figure 12.5.10], [Figure 12.5.11] are RS-422/RS-485 multi drop communication connection method.

Master (XBL-C41A)		Connection	External slave device#1	Connection	External slave device#2
Pin no.	Name				
1	TX+	_____	RX+	_____	RX+
2	TX-	_____	RX-	_____	RX-
3	RX+	_____	TX+	_____	TX+
4	RX-	_____	TX-	_____	TX-
5	S.G(SG)	_____	S.G	_____	S.G

[Figure 12.5.10] RS-422 connection

Master (XBL-C41A)		Connection	External slave device#1	Connection	External communication device#2
Pin no.	Name				
1	TX+		TX+	TX+	
2	TX-		TX-	TX-	
3	RX+		RX+	RX+	
4	RX-		RX-	RX-	
5	S.G(SG)		S.G	S.G	

[Figure 12.5.11] RS-485 connection

## 12.6 Cable Specifications

(1) When using communication channel, RS-422 or RS-485, twisted pair cable for RS-422 shall be used in consideration of communication distance and speed.

(2) [Table 12.6.1] describes recommended specifications of cable. Also when using other cable than recommended, the cable conforming to characteristics in [Table 12.6.1] shall be used.

- Product : Low Capacitance LAN Interface Cable
- Type : LIREV-AMESB
- Size : 2P X 22AWG(D/0.254 TA)
- Manufacturer: LS Cable

### 12.6.1 Electrical characteristic

Item	Standard	Test conditions
Withstanding voltage	No destruction	500V/1min
Insulation resistance	1,000 MΩ.km or above	20 °C
Static electricity capacity	45 pF/M or less	1 kHz
Characteristics impedance	120 ± 5 Ω	10 Mhz

### 12.6.2 External characteristic

Item		Unit	Standard
Conductor	Cores	Pair	2
	Size	AWG	22
	Composition	No./mm	7/0.254
	Outer dia.	mm	0.76
Insulator	Thickness	mm	0.59
	Outer dia.	mm	1.94

[Table 12.6.1] Cnet twisted pair cable standard

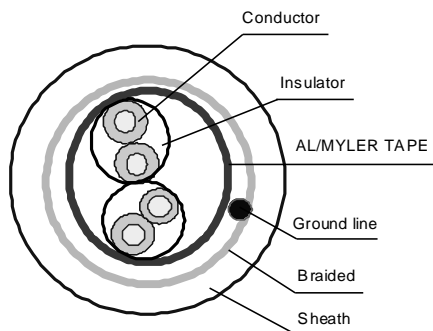

[Figure 12.6.1] Structure

## 12.7 Terminal Resistance (In case of using RS-422/485)

- (1) For communication via RS-422/RS-485 channel, terminal resistance from external must be connected.
  - (2) Terminal resistance has the function to prevent distortion of signal by reflected wave of cable for long-distance communication, and the same resistance ( $1/2W$ ) as characteristic impedance of cable must be connected to terminal of network.
  - (3) When using the recommended cable in 12.6, connect terminal resistance of  $120\Omega$  to both ends of cable. Also when using other cable than recommended, the same resistance ( $1/2W$ ) as characteristic impedance of cable must be connected to both ends of cable.
- ▶ Terminal Resistance:  $1/2W$ ,  $120\Omega$ , tolerance of 5%

- (1) How to connect terminal resistance in case of RS-422

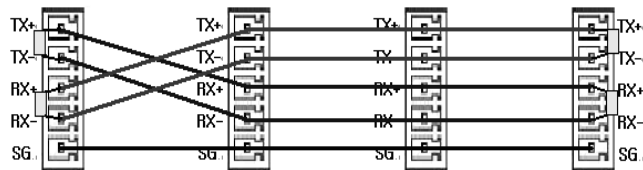

[Figure 12.7.1] Terminal resistance connection diagram in case of RS-422

- (2) How to connect terminal resistance in case of RS-485

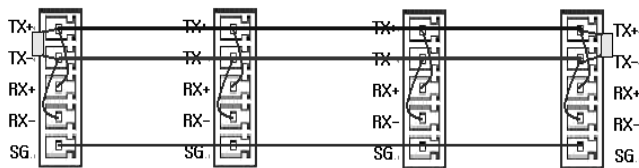

[Figure 12.7.2] Terminal resistance connection diagram in case of RS-485

## Chapter 13 Maintenance

Be sure to perform daily and periodic maintenance and inspection in order to maintain the PLC in the best conditions.

### 13.1 Maintenance and Inspection

The I/O module mainly consist of semiconductor devices and its service life is semi-permanent. However, periodic inspection is requested for ambient environment may cause damage to the devices. When inspecting one or two times per six months, check the following items.

Check Items		Judgment	Corrective Actions
Change rate of input voltage		Within change rate of input voltage (Less than -15% to +20%)	Hold it with the allowable range.
Power supply for input/output		Input/Output specification of each module	Hold it with the allowable range of each module.
Ambient environment	Temperature	0 ~ + 55°C	Adjust the operating temperature and humidity with the defined range.
	Humidity	5 ~ 95%RH	
	Vibration	No vibration	Use vibration resisting rubber or the vibration prevention method.
Play of modules		No play allowed	Securely engage the hook.
Connecting conditions of terminal screws		No loose allowed	Retighten terminal screws.
Spare parts		Check the number of Spare parts and their Store conditions	Cover the shortage and improve the conditions.

### 13.2 Daily Inspection

The following table shows the inspection and items which are to be checked daily.

Check Items		Check Points	Judgment	Corrective Actions
Connection conditions of base		Check the screws.	Screws should not be loose.	Retighten Screws.
Connection conditions of Input/Output module		Check the connecting screws Check module cover.	Screws should not be loose.	Retighten Screws.
Connecting conditions of terminal block or extension cable		Check for loose mounting screws.	Screws should not be loose.	Retighten Screws.
		Check the distance between solderless terminals.	Proper clearance should be provided.	Correct.
		Connecting of expansion cable.	Connector should not be loose.	Correct.
LED indicator	PWR LED	Check that the LED is On.	On(Off indicates an error)	See chapter 15.
	Run LED	Check that the LED is On during Run.	On (flickering indicates an error)	See chapter 15.
	ERR LED	Check that the LED is Off during Run.	Off(On indicates an error)	See chapter 15.
	Input LED	Check that the LED turns On and Off.	On when input is On, Off when input is off.	See chapter 15.
	Output LED	Check that the LED turns On and Off	On when output is On, Off when output is off	See chapter 15.

### 13.3 Periodic Inspection

Check the following items once or twice every six months, and perform the needed corrective actions.

Check Items		Checking Methods	Judgment	Corrective Actions
Ambient environment	Ambient temperature	-. Measure with thermometer and hygrometer -. measure corrosive gas	0 ~ 55 °C	Adjust to general standard (Internal environmental standard of control section)
	Ambient Humidity		5 ~ 95%RH	
	Ambient pollution level		There should be no corrosive gases	
PLC Conditions	Looseness, Ingress	The module should be move the unit	The module should be mounted securely.	Retighten screws
	dust or foreign material	Visual check	No dust or foreign material	
Connecting conditions	Loose terminal screws	Re-tighten screws	Screws should not be loose	Retighten
	Distance between terminals	Visual check	Proper clearance	Correct
	Loose connectors	Visual check	Connectors should not be loose.	Retighten connector mounting screws
Line voltage check		Measure voltage between input terminals	DC24V: DC20.4 ~ 28.8V	Change supply power



## Appendix 1 Definition of Terms

### Appendix 1.1 General Terms

Describes PLC general terms used in this manual

(1) Module

A standard element with a specific function to structure a system such as I/O board assembled to be inserted into the motherboard base

Ex) CPU module, power module, I/O module

(2) Unit

A module or a group of modules as the minimum unit operating in a PLC system being consisted of a PLC system as it is assembled with other module or a group of modules

Ex) basic unit, extension unit

(3) PLC System

A system consisting of PLC and peripherals structured to be controlled by a user's program

(4) XG5000

Programming tool creating, editing and debugging a program

(PADT: Programming And Debugging Tool)

(5) IO image area

Internal memory area of CPU module installed for keeping IO status

## Appendix 1.2 Serial Communication Terms

Describes serial communication term

### (1) Communication type

#### (a) Simplex

This is the communication type that data is transferred in a constant direction. Information can not be transferred in the reverse direction.

#### (b) Half-Duplex

Data is transferred in two ways with one cable if time interval provided, though it can't be transferred simultaneously.

#### (c) Full-Duplex

Data is simultaneously transferred and received in two ways with two cables.

### (2) Transmission type

#### (a) Serial transmission

This type transmits bit by bit via 1 cable. The speed of transmission is slow, but the cost of installation is low and the software is simplified.

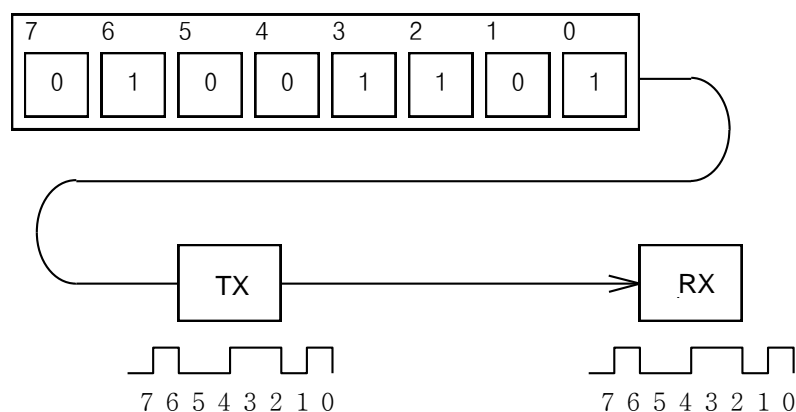

RS-232C, RS-422 and RS-485 are the examples

(b) Parallel transmission

This type is used in printer, etc., which transmits data in unit of 1 byte, so the speed is high and the accuracy of data is reliable. However, the longer the transmission distance is, the higher the cost of installation is geometrically.

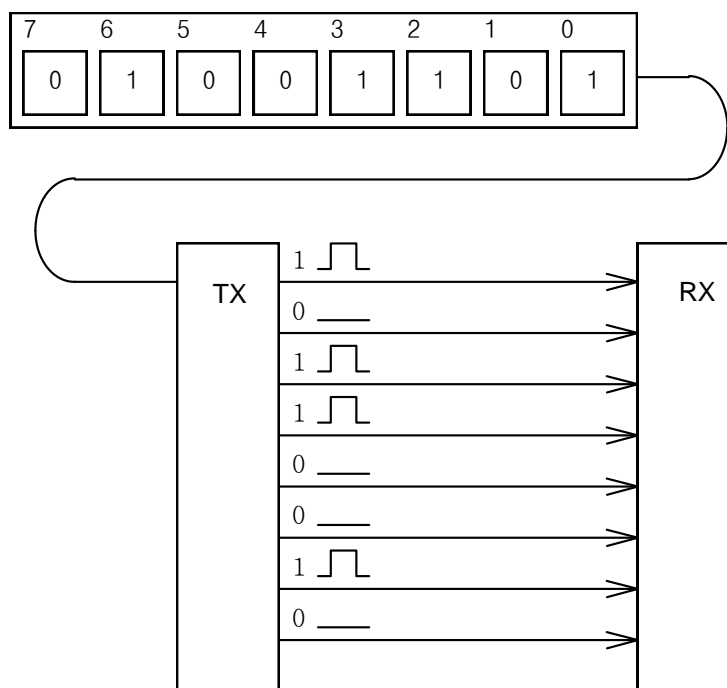

(3) Asynchronous Communication

This communication type transmits characters one by one synchronously in serial transmission. At this time, synchronous signal (Clock, etc.) is not transmitted. Character code is transmitted with a start bit attached to the head of 1 character, and it is finished with a stop bit attached to the tail.

※ For transmitting KOREA

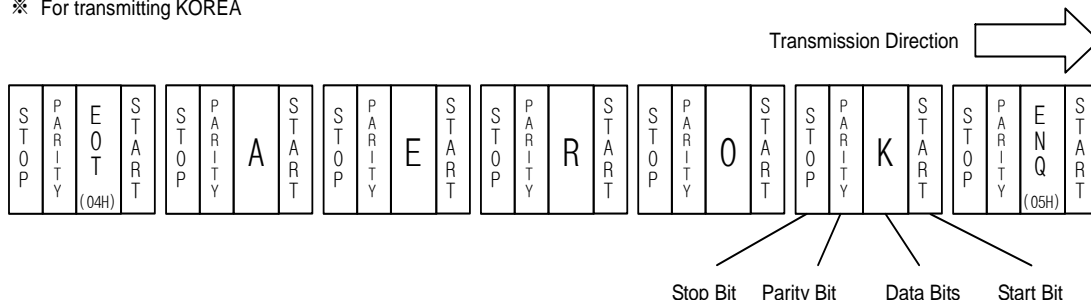

### (4) Protocol

This is communication rule established in relation between the transmission side and the receiving side of information in order to send and accept information between two computers/terminals or more without error, effectively, and reliably. In general, this specifies call establishment, connection, structure of message exchange form, re-transmission of error message, procedure of line inversion, and character synchronization between terminals, etc.

### (5) BPS(Bits Per Second)와 CPS(Characters Per Second)

BPS is a unit of transfer rate that represents how many bits are transferred per second. CPS is the number of the characters transferred for a second. Generally, one character is 1Byte (8Bits), so CPS is the number of bytes which can be transferred per second.

### (6) Node

Node is a term that means the connected nodes of the data in the network tree structure, generally network is composed of a great number of nodes, and is also expressed as the station number.

### (7) Packet

Packet, a compound term of package and bucket used for packet exchange type to send information as divided in a unit of packet, separates transferred data into the defined length to add a header that presents the correspondent addresses (station No., etc.) thereto.

### (8) Port

Port is meant to be the part of the data process device which sends or receives the data from a remote control terminal in data communications, but in Cnet serial communication is meant to be the RS-232C or RS-422 port.

### (9) RS-232C

RS-232C is the interface to link a modem with a terminal and to link a modem with a computer, and is also the serial communications specification established by EIA according to the recommendations of the CCITT. This is also used to link the null modem directly as well as the modem linkage. The disadvantage is that the transfer length is short and that only 1 : 1 communication is available, and the specifications which have overcome this disadvantage are RS-422 and RS-485.

### (10) RS-422/RS-485

As one of the serial transmission specifications, its transferring length is long with 1 : N connection available compared to RS-232C. The difference of these two specifications is that RS-422 uses 4 signals of TX(+), TX(-), RX(+) and RX(-), while RS-485 has 2 signals of (+) & (-), where data is sent and received through the same signal line. Accordingly, RS-422 executes the full-duplex type of communication and RS-485 executes the half-duplex type of communication.

(11) Half Duplex Communication

Two-way communication is available, however simultaneous communication of transmission & receiving isn't available. This communication type is applied to RS-485 for instance. It is used a lot for multi-drop communication type which communicates via one signal line by several stations. Half Duplex Communication results from the transmission characteristic performed by stations one by one not allowing simultaneous transmission by multi stations due to the data damage of data impact caused by the simultaneous multi-transmission of the stations. The figure below shows an example of structure based on Half Duplex Communication. Each station in communication with the terminal as linked with each other can send or receive data via one line so to execute communication with all stations, where multi-sever is advantageously available.

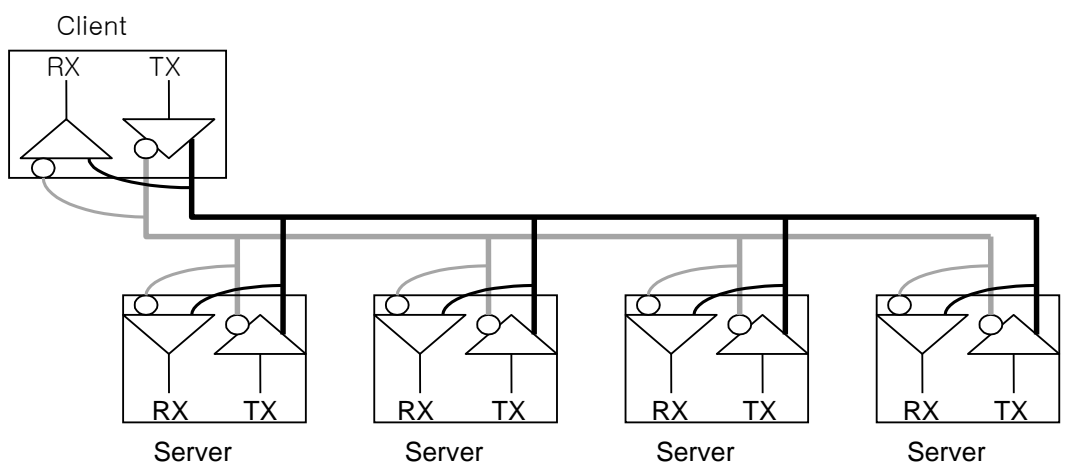

(12) Full Duplex Communication

Two way-communications of simultaneous transmission & receiving is available. This communication type is applied to RS-232C & RS-422. Since the transmission line is separated from the receiving line, simultaneous transmission & receiving is available without data impact, so called as Full Duplex Communication. The figure shows an example of structure based on RS-422 of Full Duplex Communication. Since transmission terminal of the client station and receiving terminals of the sever stations are connected to one line, and transmission terminals of the sever stations are linked with receiving terminal of the client station, the communication between sever stations is unavailable with the restricted function of multi-sever.

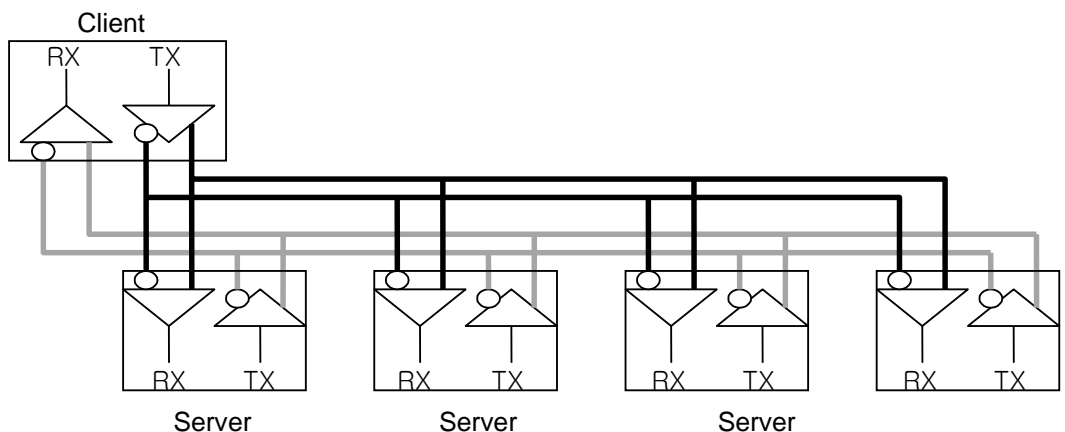

(13) BCC (Block Check Character)

As serial transmission may have signals distorted due to undesirable noise in transmission line, BCC is used as data to help receiving side to check the signals if normal or distorted and to detect errors in signals as compared with the received BCC after calculating BCC by receiving side itself using the data input to the front terminal of BCC.

(14) XG5000 service

This is the function to remotely perform programming, reading/writing user's program, debugging, and monitoring, etc. without moving the physical connection of XG5000 in the network system where PLC is connected to Cnet I/F module. Especially, it is convenient to control a remote PLC via modem.

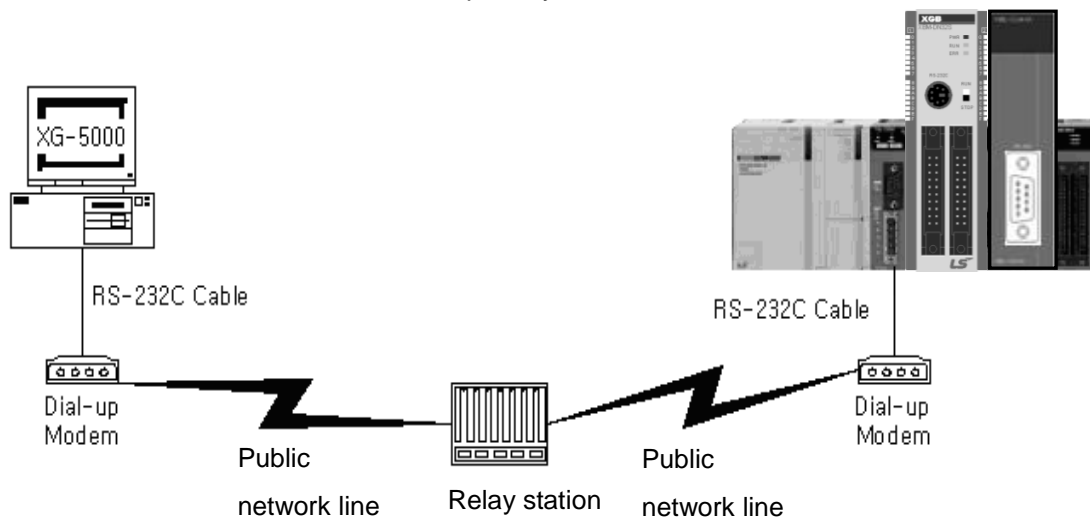

\* XG5000: Programming software of XGT PLC for Windows

(15) Frame

Frame is composed of transmitted and received data as in a specified form in data communication including additional information of segments [station No., command, parameter by command], control characters [ENQ, ACK, EOT, ETX] for synchronization, parity for detecting error, and BCC. The structure of frame used for serial communication of Cnet is as follows.

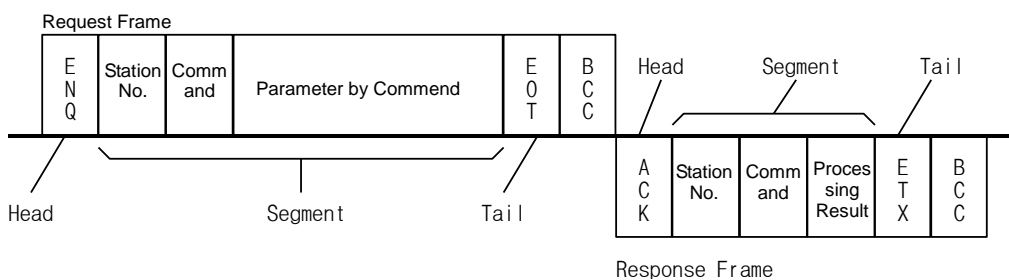

[Structure of general Tx/Rx frame]

- Head: ASCII value indicating frame start.
- Tail: ASCII value indicating frame end.
- BCC (Block Check Character)
  - ◆ Check data for Tx/Rx frame
  - ◆ Used to inspect reliability of data with such various methods as ADD, OR, Exclusive OR, MULTPLY, etc

(16) Reset

This function is used to initialize the communication module with errors.

Use XG5000 to select [On-Line] → [Reset/Clear] → [Reset PLC] so to execute Reset, which will restart PLC.

## Appendix 2 Communication Relay List (L)

### Appendix 2.1 Communication Relay (L) List

Here describes data link communication relay(L).

#### (1) High-speed Link 1

Device	IEC type	Keyword	Type	Description
L000	%LX000	_HS1_RLINK	Bit	High speed link parameter 1 normal operation of all station Indicates normal operation of all station according to parameter set in High speed link, and On under the condition as below. 1. In case that all station set in parameter is RUN mode and no error, 2. All data block set in parameter is communicated normally, and 3. The parameter set in each station itself is communicated normally. Once RUN_LINK is On, it keeps On unless stopped by LINK_DISABLE.
L001	%LX001	_HS1_LTRBL	Bit	Abnormal state after _HS1RLINK On In the state of _HSmRLINK flag On, if communication state of the station set in the parameter and data block is as follows, this flag shall be On. 1. In case that the station set in the parameter is not RUN mode, or 2. There is an error in the station set in the parameter, or 3. The communication state of data block set in the parameter is not good. LINK TROUBLE shall be On if the above 1, 2 & 3 conditions occur, and if the condition return to the normal state, it shall be OFF again.
L0020 ~ L005F	%LX032 ~ %LX095	_HS1_STATE[k] (k = 00~63)	Bit Array	High speed link parameter 1, k block general state Indicates the general state of communication information for each data block of setting parameter. _HS1_STATE[k] = HS1MOD[k]&_HS1TRX[k]&(~_HS1_ERR[k])
L0060 ~ L009F	%LX096 ~ %LX159	_HS1_MOD[k] (k = 00~63)	Bit Array	High speed link parameter 1, k block station RUN operation mode Indicates operation mode of station set in k data block of parameter.
L0100 ~ L013F	%LX160 ~ %LX223	_HS1_TRX[k] (k = 00~63)	Bit Array	Normal communication with High speed link parameter 1, k block station Indicates if communication state of k data of parameter is communicated smoothly according to the setting.
L0140 ~ L017F	%LX224 ~ %LX287	_HS1_ERR[k] (k = 00~63)	Bit Array	High speed link parameter 1, k block station operation error mode Indicates if the error occurs in the communication state of k data block of parameter.
L0180 ~ L021F	%LX288 ~ %LX767	_HS1_SETBLO CK[k]	Bit Array	High speed link parameter 1, k block setting Indicates whether or not to set k data block of parameter.



(2) High-speed Link 2

Device	IEC type	Keyword	Type	Description
L0260	%LX416	_HS2_RLINK	Bit	<p>High-speed link parameter 2 normal operation of all station.</p> <p>Indicates normal operation of all station according to parameter set in High-speed link and On under the condition as below.</p> <ol style="list-style-type: none"> <li>1. In case that all station set in parameter is Run mode and no error</li> <li>2. All data block set in parameter is communicated and</li> <li>3. The parameter set in each station itself is communicated normally.</li> </ol> <p>Once RUN_LINK is On, it keeps On unless stopped by LINK_DISABLE.</p>
L0261	%LX417	_HS2_LTRBL	Bit	<p>Abnormal state after _HS2RLINK On.</p> <p>In the state of _HSmRLINK flag On, if communication state of the station set in the parameter and data block is as follows, this flag shall be On.</p> <ol style="list-style-type: none"> <li>1. In case that the station set in the parameter is not RUN mode, or</li> <li>2. There is an error in the station set in the parameter, or</li> <li>3. The communication state of data block set in the parameter is not good.</li> </ol> <p>LINK TROUBLE shall be On if the above 1, 2 &amp; 3 conditions occur, and if the condition return to the normal state, it shall be OFF again.</p>
L0280 ~ L031F	%LX448 ~ %LX511	_HS2_STATE[k] (k = 00~63)	Bit Array	<p>High speed link parameter 1, k block general state.</p> <p>Indicates the general state of communication information for each data block of setting parameter.</p> <p>_HS2_STATE[k]=HS2MOD[k]&amp;_HS2TRX[k]&amp;(~_HS2_ERR[k])</p>
L0320 ~ L035F	%LX512 ~ %LX575	_HS2_MOD[k] (k = 00~63)	Bit Array	<p>High speed link parameter 1, k block station RUN operation mode.</p> <p>Indicates operation mode of station set in k data block of parameter.</p>
L0360 ~ L039F	%LX576 ~ %LX639	_HS2_TRX[k] (k = 00~63)	Bit Array	<p>Normal communication with High speed link parameter 1, k block station.</p> <p>Indicates if communication state of k data of parameter is communicated smoothly according to the setting.</p>
L0400 ~ L043F	%LX640 ~ %LX703	_HS2_ERR[k] (k = 00~63)	Bit Array	<p>High speed link parameter 1, k block station operation error mode.</p> <p>Indicates if the error occurs in the communication state of k data block of parameter.</p>
L0440 ~ L047F	%LX704 ~ %LX767	_HS2_SETBLO CK[k]	Bit Array	<p>High speed link parameter 1, k block setting.</p> <p>Indicates whether or not to set k data block of parameter.</p>

### (3) Common area

Communication flag according to P2P service setting  
 In case of XGB, P2P parameter is 1~3, P2P block is 0~31.

Device	IEC type	Keyword	Type	Description
L5120	%LX8192	_P2P1_NDR00	Bit	Indicates P2P parameter 1, 0 Block service normal end.
L5121	%LX8193	_P2P1_ERR00	Bit	Indicates P2P parameter 1, 0 Block service abnormal end.
L513	%LW513	_P2P1_STATUS00	Word	Indicates error code in case of P2P parameter 1, 0 Block service abnormal end.
L514	%LD257	_P2P1_SVCCNT00	Double Word	Indicates P2P parameter 1, 0 Block service normal count.
L516	%LD258	_P2P1_ERRCNT00	Double Word	Indicates P2P parameter 1, 0 Block service abnormal count.
L07040	%LX11264	_P2P2_NDR00	Bit	Indicates P2P parameter 2, 0 Block service normal end.
L07041	%LX11265	_P2P2_ERR00	Bit	Indicates P2P parameter 2, 0 Block service abnormal end.
L0705	%LW705	_P2P2_STATUS00	Word	Indicates error code in case of P2P parameter 2, 0 Block service abnormal end.
L0706	%LD353	_P2P2_SVCCNT00	Double Word	Indicates P2P parameter 2, 0 Block service normal count.
L0708	%LD354	_P2P2_ERRCNT00	Double Word	Indicates P2P parameter 2, 0 Block service abnormal count.
L08960	%LX14336	_P2P3_NDR00	Bit	Indicates P2P parameter 3, 0 Block service normal end.
L08961	%LX14337	_P2P3_ERR00	Bit	Indicates P2P parameter 3, 0 Block service abnormal end.
L0897	%LW897	_P2P3_STATUS00	Word	Indicates error code in case of P2P parameter 3, 0 Block service abnormal end.
L0898	%LD449	_P2P3_SVCCNT00	Double Word	Indicates P2P parameter 3, 0 Block service normal count.
L0900	%LD450	_P2P3_ERRCNT00	Double Word	Indicates P2P parameter 3, 0 Block service abnormal count.

## Appendix 2.2 Network Register (N) List

Here describes about network register ( P2P parameter: 1~3, P2P block: 0~31 )

Device	IEC type	Keyword	Type	Description
N000	%NW000	_P1B00SN	Word	Saves another station no. of P2P parameter 1, 00 block.
N0000~0004	%NW0001 ~0005	_P1B00RD1	Word	Saves area device 1 to read P2P parameter 1, 01 block.
N005	%NW006	_P1B00RS1	Word	Saves area size 1 to read P2P parameter 1, 01 block.
N0006~0009	%NW0007 ~0011	_P1B00RD2	Word	Saves area device 2 to read P2P parameter 1, 01 block.
N010	%NW012	_P1B00RS2	Word	Saves area size 2 to read P2P parameter 1, 01 block.
N0011~0014	%NW0013 ~0017	_P1B00RD3	Word	Saves area device 3 to read P2P parameter 1, 01 block.
N015	%NW018	_P1B00RS3	Word	Saves area size 3 to read P2P parameter 1, 01 block.
N0016~0019	%NW0019 ~0023	_P1B00RD4	Word	Saves area device 4 to read P2P parameter 1, 01 block.
N020	%NW024	_P1B00RS4	Word	Saves area size 4 to read P2P parameter 1, 01 block.
N0021~0024	%NW0025 ~0029	_P1B00WD 1	Word	Saves area device 1 to save P2P parameter 1, 01 block.
N025	%NW030	_P1B00WS1	Word	Saves area size 1 to save P2P parameter 1, 01 block.
N0026~0029	%NW0031 ~0035	_P1B00WD 2	Word	Saves area device 2 to save P2P parameter 1, 01 block.
N030	%NW036	_P1B00WS2	Word	Saves area size 2 to save P2P parameter 1, 01 block.
N0031~0034	%NW0037 ~0041	_P1B00WD 3	Word	Saves area device 3 to save P2P parameter 1, 01 block.
N035	%NW042	_P1B00WS3	Word	Saves area size 3 to save P2P parameter 1, 01 block.
N0036~0039	%NW0043 ~0047	_P1B00WD 4	Word	Saves area device 4 to save P2P parameter 1, 01 block.
N040	%NW0048	_P1B00WS4	Word	Saves area size 4 to save P2P parameter 1, 01 block.
N0041~0081	%NW0049 ~0097	-	Word	Saving area of P2P parameter 1, 01 block.
N0082~0122	%NW0098 ~0146	-	Word	Saving area of P2P parameter 1, 02 block. P2P
N0123~1311	%NW0147 ~1567	-	Word	Saving area of P2P parameter 1, 03~31 block.
N1312~2623	%NW1568 ~3135	-	Word	Saving area of P2P parameter 2.
N2624~3935	%NW3136 ~4703	-	Word	Saving area of P2P parameter 3.

### Remark

- In XGB S type, Network register is available only monitoring. (Read Only)

## Appendix 3 Communication Error Code

### Appendix 3.1 XGT Server Error Code

Error code is displayed as hex 2 byte (4 byte as ASCII code). The user can see error by frame monitor and in case of viewing by ASCII, the user can see the following error code.

Error code	Error type	Error details and causes	Example
0003	Number of blocks exceeded	Number of blocks exceeds 16 at Individual Read/Write Request	01rSS1105%MW10...
0004	Variable length error	Variable Length exceeds the max. size of 16	01rSS010D%MW1000000000..
0007	Data type error	Other data type than X,B,W,D,L received	01rSS0105%MK10
0011	Data error	In case % is unavailable to start with	01rSS0105MW0
		Variable's area value wrong	01rSS0105%MWM
		Other value is written for Bit Write than 00 or 01	01wSS0105%MX1011
0090	Monitor execution error	Unregistered monitor execution requested	
0190	Monitor execution error	Reg. No. range exceeded	
0290	Monitor reg. Error	Reg. No. range exceeded	
1132	Device memory error	Other letter than applicable device is input	
1232	Data size error	Request exceeds the max range of 60 Words to read or write at a time.	01wSB05%MW1040AA5512,..
1234	Extra frame error	Unnecessary details exist as added.	01rSS0105%MW10000
1332	Data type discordant	All the blocks shall be requested of the identical data type in the case of Individual Read/Write	01rSS0205%MW1005%MB10
1432	Data value error	Data value unavailable to convert to Hex	01wSS0105%MW10AA%5
7132	Variable request area exceeded	Request exceeds the area each device supports.	01rSS0108%MWFFFFFF

### Appendix 3.2 Modbus Server Error Code

Error code is displayed as hex 1 byte (2 byte as ASCII code) and indicates type of error.

Code	Error type	Error details and causes
01	Illegal Function	Function code error
02	Illegal Address	Address range exceeded
03	Illegal Data Value	Data value not allowed

### Appendix 3.3 P2P Client Error Code

Indicates error code shown at monitoring window of XG5000

Code	Error type	Error details and causes
01	ERR_NO_HEAD	There is no head of receive frame
02	ERR_NO_TAIL	There is no tail of receive frame
03	ERR_WRONG_BCC	BCC is not correct
04	ERR_STATION_NO	Station number of receive frame is not correct
05	ERR_WRONG_DRV_TYPE	Driver type is not correct
07	ERR_FRAME_SND	Can't send TX frame
09	ERR_NO_USE_LINKID	There is no communication module
0A	ERR_PLC_RESP_TIMEOUT	Receive frame is not received during time out setting time
0B	ERR_FRM_LENGTH	Length of receive frame is not correct
0D	ERR_ASCII_HEX_ERR	ASC-HEX conversion of receive frame is not correct
0E	ERR_RANGE_OVER	Area of device is exceeded
0F	ERR_NAK_ERR	Response of receive frame is NAK

## Appendix 4 Dimension (Unit : mm)

- (1) Stand type main unit ("S" type)
- XBM-DN16S/32S

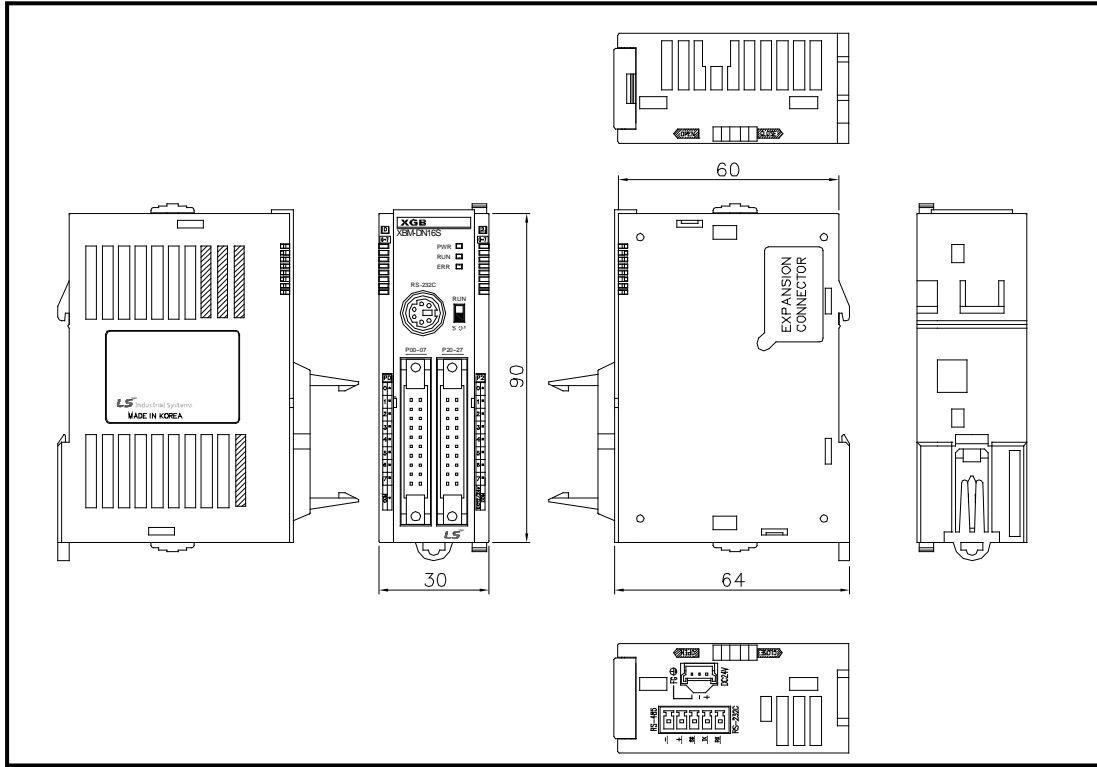

- XBM-DR16S

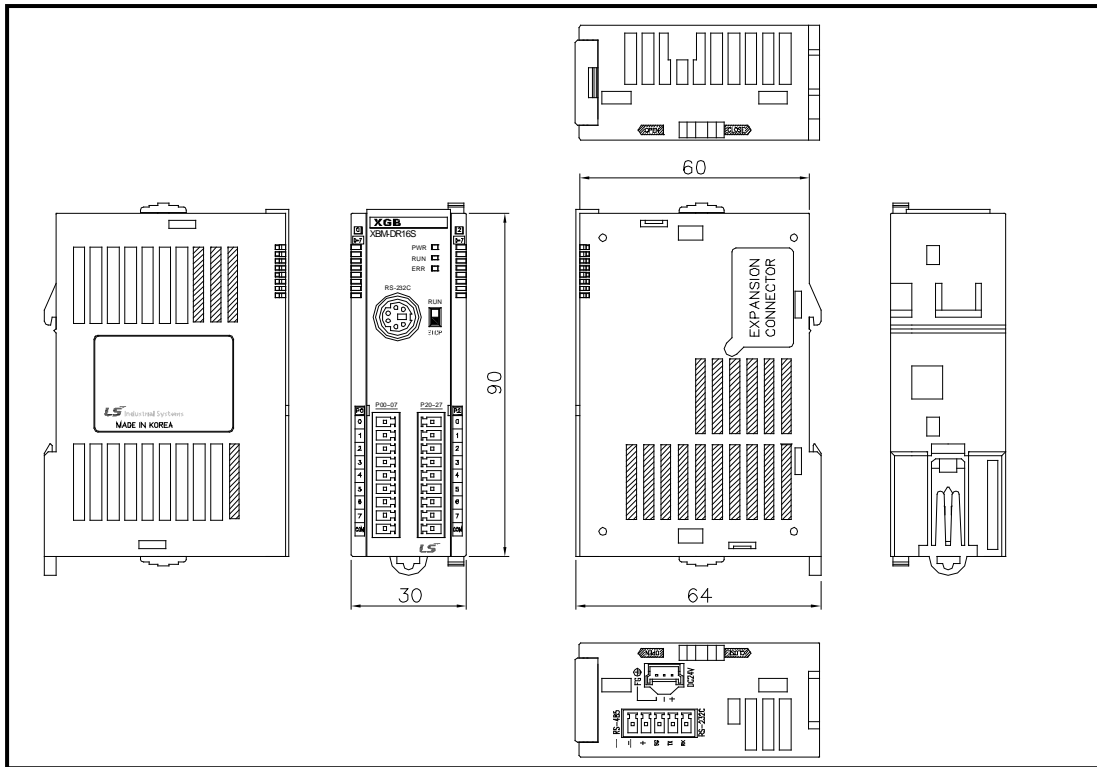

(2) Compact type main unit ("H" type)

-. XBC-DN32H / XEC-DN32H

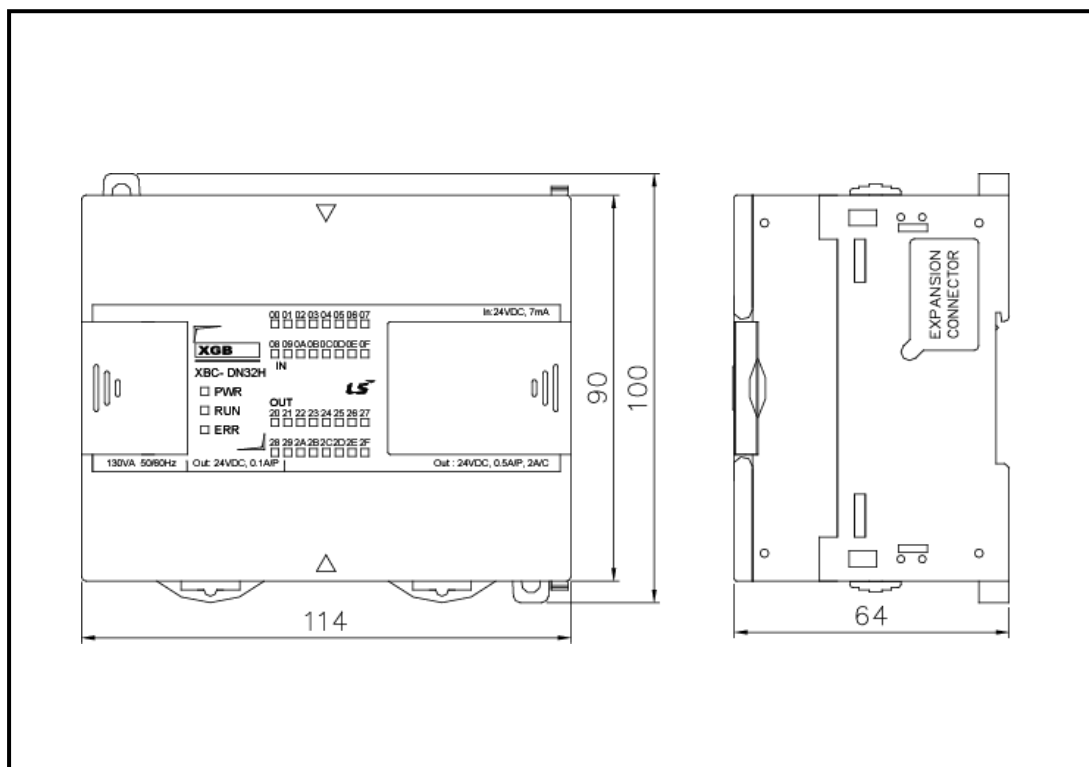

-. XBC-DR32H / XEC-DR32H

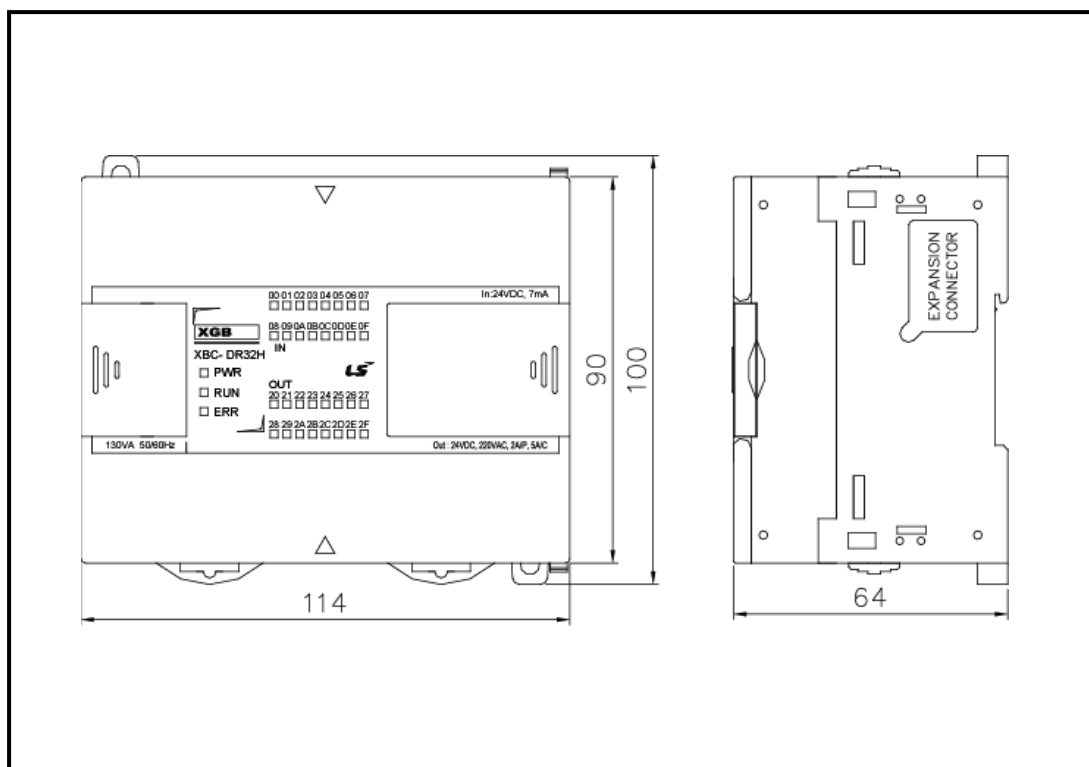

# Appendix4 Dimension

-. XBC-DN64H / XEC-DN64H

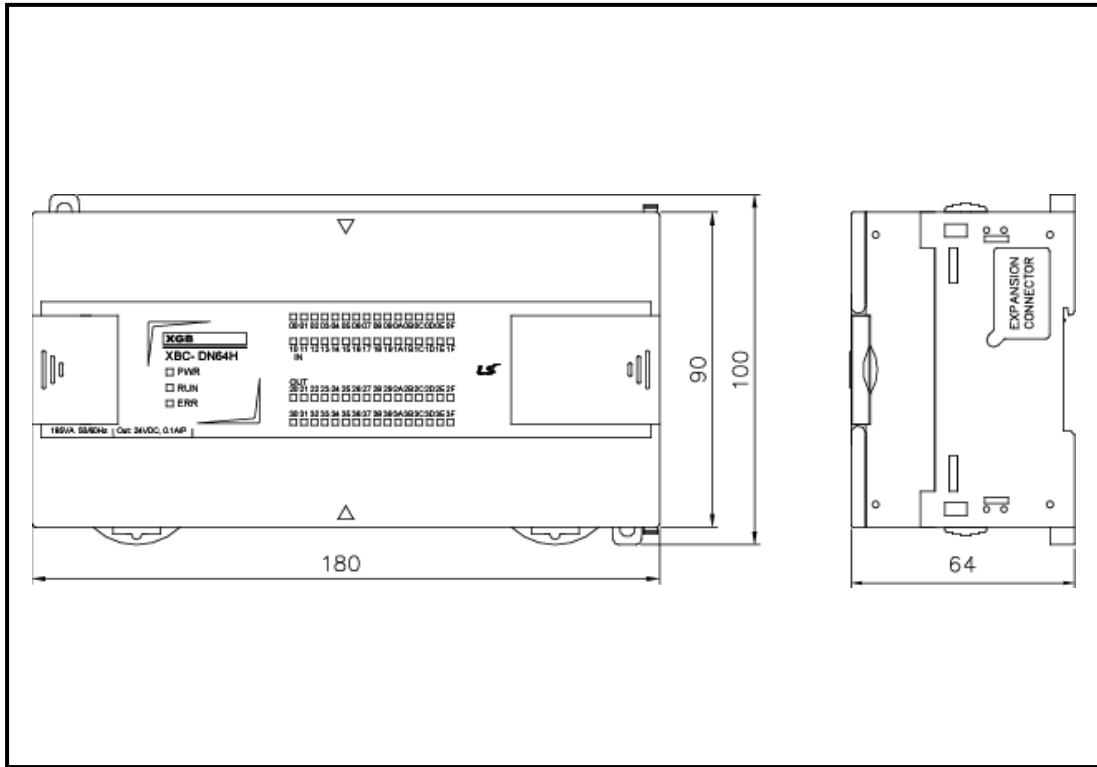

-. XBC-DR64H / XEC-DR64H

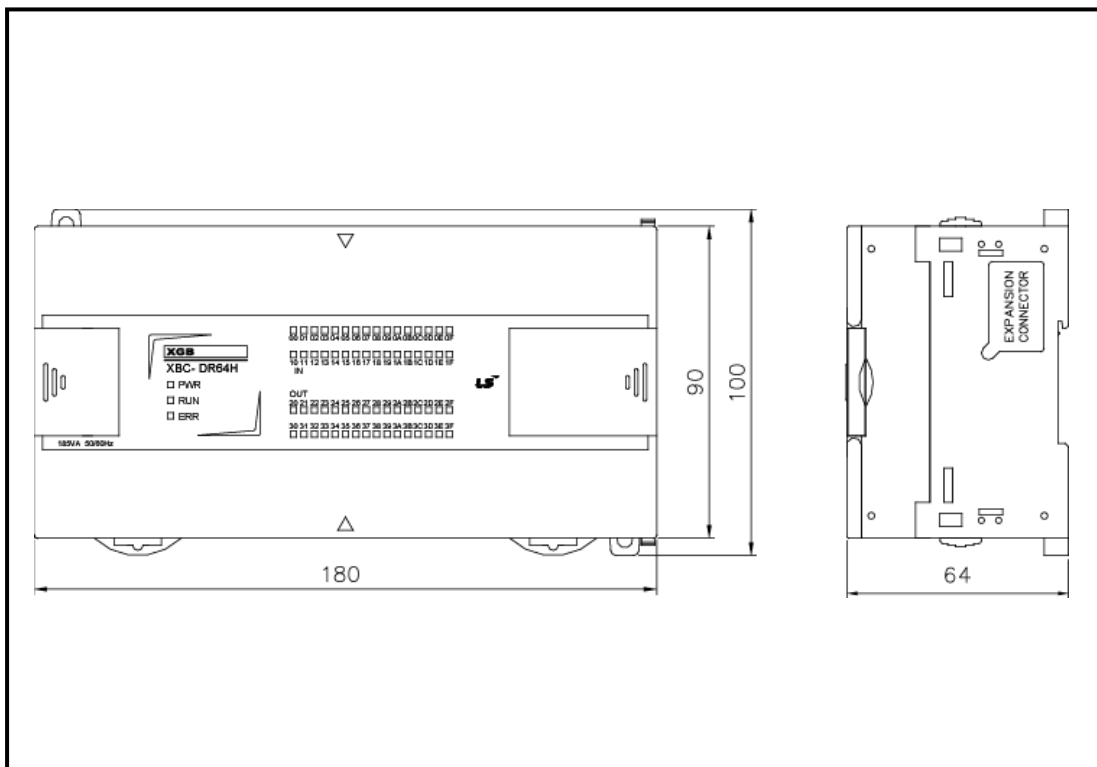



(3) Extension type Cnet I/F module

- . XBL-C41A, XBL-C21A

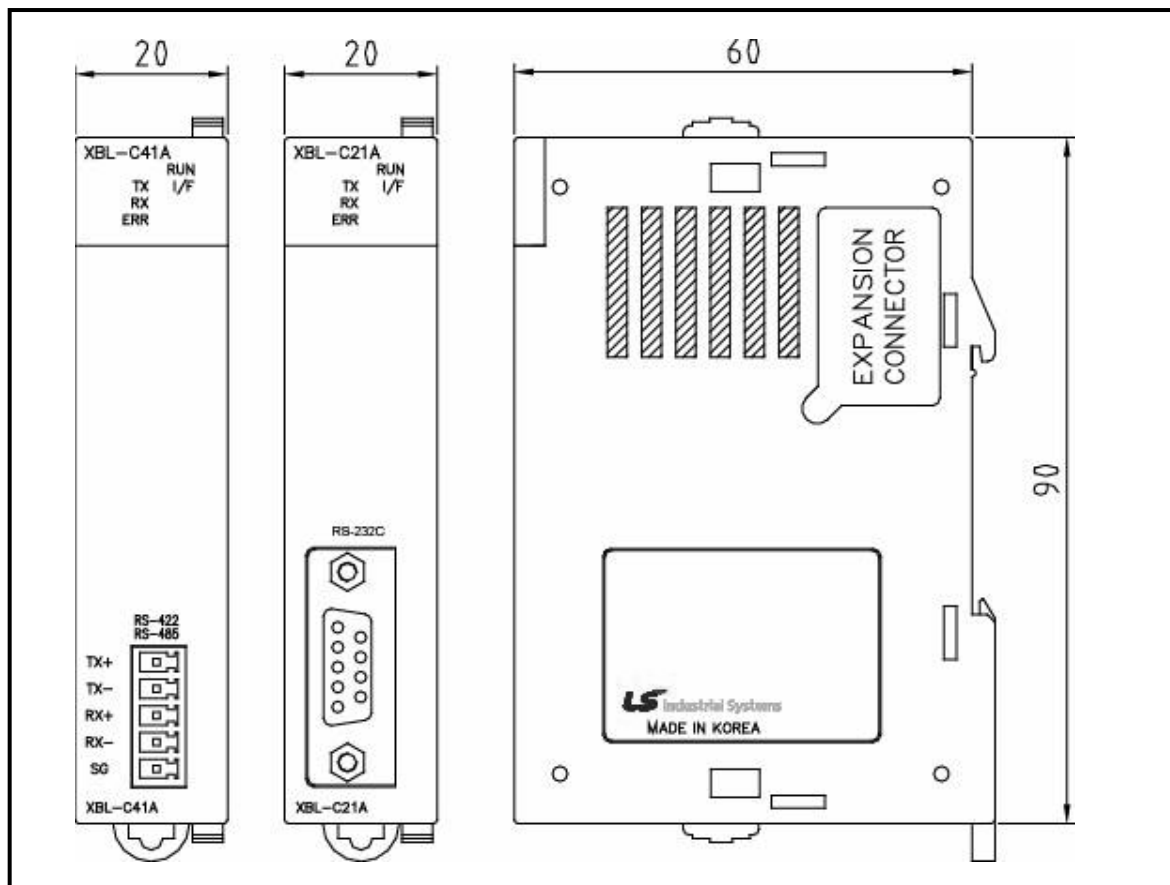

## Warranty

1. Warranty Period

The product you purchased will be guaranteed for 18 months from the date of manufacturing.

2. Scope of Warranty

Any trouble or defect occurring for the above-mentioned period will be partially replaced or repaired. However, please note the following cases will be excluded from the scope of warranty.

- (1) Any trouble attributable to unreasonable condition, environment or handling otherwise specified in the manual,
- (2) Any trouble attributable to others' products,
- (3) If the product is modified or repaired in any other place not designated by the company,
- (4) Due to unintended purposes
- (5) Owing to the reasons unexpected at the level of the contemporary science and technology when delivered.
- (6) Not attributable to the company; for instance, natural disasters or fire

3. Since the above warranty is limited to PLC unit only, make sure to use the product considering the safety for system configuration or applications.

## Environmental Policy

LS ELECTRIC Co., Ltd supports and observes the environmental policy as below.

### Environmental Management

LS ELECTRIC considers the environmental preservation as the preferential management subject and every staff of LS ELECTRIC use the reasonable endeavors for the pleasurable environmental preservation of the earth.

### About Disposal

LS ELECTRIC' PLC unit is designed to protect the environment. For the disposal, separate aluminum, iron and synthetic resin (cover) from the product as they are reusable.



[www.ls-electric.com](http://www.ls-electric.com)

## LS ELECTRIC Co., Ltd.

### ■ Headquarter

LS-ro 127(Hogye-dong) Dongan-gu, Anyang-si, Gyeonggi-Do, 14119, Korea

### ■ Seoul Office

LS Yongsan Tower, 92, Hangang-daero, Yongsan-gu, Seoul, 04386, Korea

Tel: 82-2-2034-4033, 4888, 4703 Fax: 82-2-2034-4588

E-mail: [automation@ls-electric.com](mailto:automation@ls-electric.com)

### ■ Overseas Subsidiaries

#### • LS ELECTRIC Japan Co., Ltd. (Tokyo, Japan)

Tel: 81-3-6268-8241 E-Mail: [japan@ls-electric.com](mailto:japan@ls-electric.com)

#### • LS ELECTRIC (Dalian) Co., Ltd. (Dalian, China)

Tel: 86-411-8730-6495 E-Mail: [china.dalian@lselectric.com.cn](mailto:china.dalian@lselectric.com.cn)

#### • LS ELECTRIC (Wuxi) Co., Ltd. (Wuxi, China)

Tel: 86-510-6851-6666 E-Mail: [china.wuxi@lselectric.com.cn](mailto:china.wuxi@lselectric.com.cn)

#### • LS ELECTRIC Middle East FZE (Dubai, U.A.E.)

Tel: 971-4-886-5360 E-Mail: [middleeast@ls-electric.com](mailto:middleeast@ls-electric.com)

#### • LS ELECTRIC Europe B.V. (Hoofddorp, Netherlands)

Tel: 31-20-654-1424 E-Mail: [europartner@ls-electric.com](mailto:europartner@ls-electric.com)

#### • LS ELECTRIC America Inc. (Chicago, USA)

Tel: 1-800-891-2941 E-Mail: [sales.us@lselectricamerica.com](mailto:sales.us@lselectricamerica.com)

#### • LS ELECTRIC Turkey Co., Ltd.

Tel: 90-212-806-1225 E-Mail: [turkey@ls-electric.com](mailto:turkey@ls-electric.com)

### ■ Overseas Branches

#### • LS ELECTRIC Tokyo Office (Japan)

Tel: 81-3-6268-8241 E-Mail: [tokyo@ls-electric.com](mailto:tokyo@ls-electric.com)

#### • LS ELECTRIC Beijing Office (China)

Tel: 86-10-5095-1631 E-Mail: [china.auto@lselectric.com.cn](mailto:china.auto@lselectric.com.cn)

#### • LS ELECTRIC Shanghai Office (China)

Tel: 86-21-5237-9977 E-Mail: [china.auto@lselectric.com.cn](mailto:china.auto@lselectric.com.cn)

#### • LS ELECTRIC Guangzhou Office (China)

Tel: 86-20-3818-2883 E-Mail: [china.auto@lselectric.com.cn](mailto:china.auto@lselectric.com.cn)

#### • LS ELECTRIC Chengdu Office (China)

Tel: 86-28-8670-3201 E-Mail: [china.auto@lselectric.com.cn](mailto:china.auto@lselectric.com.cn)

#### • LS ELECTRIC Qingdao Office (China)

Tel: 86-532-8501-2065 E-Mail: [china.auto@lselectric.com.cn](mailto:china.auto@lselectric.com.cn)

#### • LS ELECTRIC Nanjing Office (China)

Tel: 86-25-8467-0005 E-Mail: [china.auto@lselectric.com.cn](mailto:china.auto@lselectric.com.cn)

#### • LS ELECTRIC Bangkok Office (Thailand)

Tel: 66-90-950-9683 E-Mail: [thailand@ls-electric.com](mailto:thailand@ls-electric.com)

#### • LS ELECTRIC Jakarta Office (Indonesia)

Tel: 62-21-2933-7614 E-Mail: [indonesia@ls-electric.com](mailto:indonesia@ls-electric.com)

#### • LS ELECTRIC Moscow Office (Russia)

Tel: 7-499-682-6130 E-Mail: [info@lselectric-ru.com](mailto:info@lselectric-ru.com)

#### • LS ELECTRIC America Western Office (Irvine, USA)

Tel: 1-949-333-3140 E-Mail: [america@ls-electric.com](mailto:america@ls-electric.com)

### Disclaimer of Liability

LS ELECTRIC has reviewed the information in this publication to ensure consistency with the hardware and software described. However, LS ELECTRIC cannot guarantee full consistency, nor be responsible for any damages or compensation, since variance cannot be precluded entirely. Please check again the version of this publication before you use the product.

© LS ELECTRIC Co., Ltd 2015 All Right Reserved.

2022.08